

Ružičkini dani : Međunarodni znanstveno-stručni skup 16. Ružičkini dani „Danas znanost - sutra industrija“ : zbornik radova

Alivojvodić, Sara; Babić, Kristina; Bakula, Ivan; Balta, Vedran; Belščak-Cvitanović, Ana; Benković, Maja; Briški, Felicita; Brkić, Danijel; Brozinčević, Andrijana; Bukvić, Valerija; ...

Edited book / Urednička knjiga

Publication status / Verzija rada: **Published version / Objavljena verzija rada (izdavačev PDF)**

Publication year / Godina izdavanja: **2017**

Permanent link / Trajna poveznica: <https://um.nsk.hr/um:nbn:hr:109:603123>

Rights / Prava: [Attribution-NonCommercial-NoDerivatives 4.0 International/Imenovanje-Nekomercijalno-Bez prerada 4.0 međunarodna](#)

Download date / Datum preuzimanja: **2025-02-22**

REPOZITORIJ

PTF

PREHRAMBENO-TEHNOLOŠKI FAKULTET OSIJEK

dabar
DIGITALNI AKADEMSKI ARHIVI I REPOZITORIJI

Repository / Repozitorij:

[Repository of the Faculty of Food Technology Osijek](#)



dabar
DIGITALNI AKADEMSKI ARHIVI I REPOZITORIJI



Croatian Society of Chemical Engineers
Faculty of Food Technology
University of Josip Juraj Strossmayer in Osijek
European Federation of Food Science & Technology
European Association for Chemical and Molecular Sciences
European Hygienic Engineering & Design Group

INTERNATIONAL CONFERENCE
16th Ružička days
“TODAY SCIENCE – TOMORROW INDUSTRY”

PROCEEDINGS

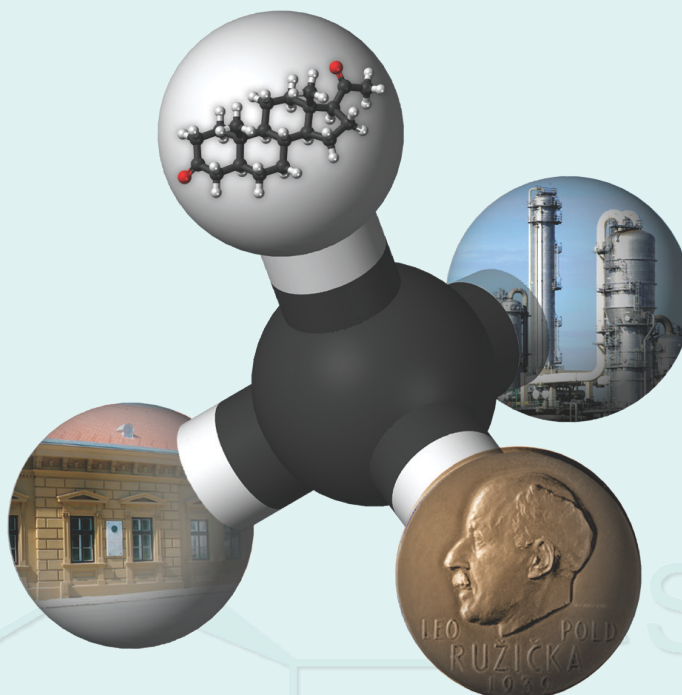

September 21–23, 2016
Vukovar, Croatia

Zagreb, 2017.



PTF



Hrvatsko društvo kemijskih inženjera i tehnologa
Prehrambeno-tehnološki fakultet
Sveučilišta Josipa Jurja Strossmayera u Osijeku
European Federation of Food Science & Technology
European Association for Chemical and Molecular Sciences
European Hygienic Engineering & Design Group

međunarodni znanstveno-stručni skup

16. Ružičkini dani

“DANAS ZNANOST – SUTRA INDUSTRIJA”

ZBORNİK RADOVA

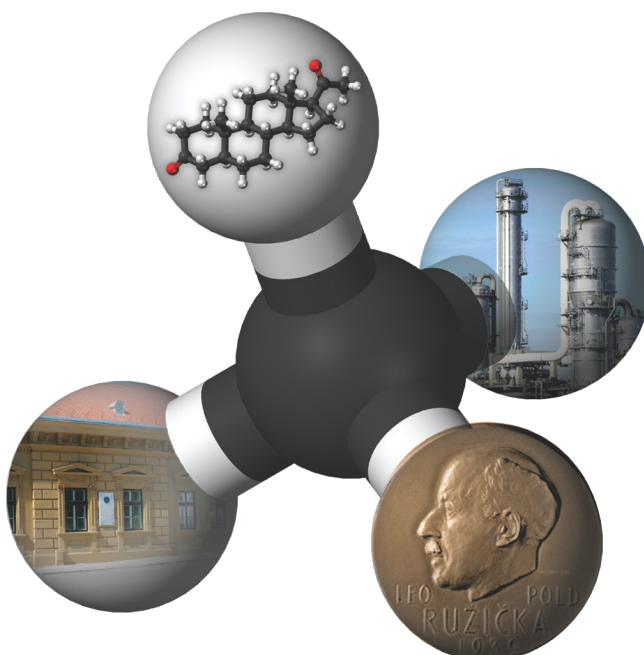

21. – 23. rujna 2016.
Vukovar, Hrvatska

Zagreb, 2017.

SUSRET MLADIH KEMIČARA

21. rujna 2016., VUKOVAR, HRVATSKA



$$Re = \frac{vdp}{\eta}$$

ZNAŠ ŠTO
BI SE DOGODILO DA
SE SILVER SURFER
I IRON MAN
UJEDINE?

ZNAM....
POSTALI BI
LEGURA!



PROCEEDINGS *16th Ružička days*
TODAY SCIENCE – TOMORROW INDUSTRY

ZBORNIK RADOVA 16. Ružičkini dani
DANAS ZNANOST – SUTRA INDUSTRIJA

Published by / Izdavači Hrvatsko društvo kemijskih inženjera i tehnologa (HDKI)
Prehrambeno-tehnološki fakultet Osijek
Sveučilišta Josipa Jurja Strossmayera u Osijeku
Croatian Society of Chemical Engineers (CSCE)
Faculty of Food Technology Osijek
University of Josip Juraj Strossmayer in Osijek

Chief Editors / Glavni urednik Ante Jukić, Drago Šubarić

**Executive and Technical Editors /
Izvršni i tehnički urednici** Vesna Očelić Bulatović, Antun Jozinović

**Proceedings Reviews /
Recenzenti Zbornika** Lidija Čurković, Mirela Kopjar

Text prepared by / Tekst pripremili *AUTHORS, who are fully responsible for the manuscripts*
AUTORI, koji su odgovorni za tekst cjelovitih radova

Cover sheet design / Dizajn naslovnice Zdenko Blažeković

Printing and Binding / Tisak i uvez Grafoprojekt, Virovitica, Hrvatska

Number of Copies / Naklada 150

**Scientific and Organizing Committee /
Znanstveno-organizacijski odbor** Ante Jukić (predsjednik/*chairman*),
Drago Šubarić (dopredsjednik/*vice-chairman*),
Srećko Tomas (dopredsjednik/*vice-chairman*),
Đurđica Ačkar, Jurislav Babić, Nenad Bolf, Dajana Gašo-
Sakač, Ljubica Glavaš-Obrovac, Ivan Hubalek, Stela Jokić,
Franjo Jović, Antun Jozinović, Ljerka Kratofil Krehula,
Ivanka Miličić, Maja Molnar, Vesna Očelić Bulatović,
Mirela Planinić, Jasmina Ranilović, Milan Sak-Bosnar,
Irena Škorić, Elvira Vidović

**Honorary Committee /
Počasni odbor** Božo Galić, Marin Hraste, Zvonimir Janović, Leo Klasinc,
Filip Kljajić, Gordan Kolundžić, Ruža Marić, Ivan Penava,
Vlasta Piližota, Damir Skender, Mirko Smoljić, Vitomir
Šunjić, Nenad Trinajstić, Željko Turkalj

Acknowledgement to reviewers

The Editors of the *Proceedings* of the 16th *Ružička days* extend their deepest gratitude to the following manuscript reviewers who maintained the professional standards of our *Proceedings* of the 16th *Ružička days*:

Ačkar, Đurđica; Babić, Jurislav; Banjari, Ines; Brnardić, Ivan; Bušić, Valentina; Ćosić, Jasenka; Čukelj, Nikolina; Erceg, Matko; Faraguna, Fabio; Flanjak, Ivana; Gašo Sokač, Dajana; Grčić, Ivana; Iličković, Zoran; Jakić, Miće; Jakobek Barron, Lidija; Jokić, Stela; Jašić, Midhat; Jozinović, Antun; Jukić, Ante; Jurinjak Tušek, Ana; Kučić, Dajana; Kurajica, Stanislav; Kurtanjek, Želimir; Lončarić, Ante; Lovrić, Jasna; Mandić, Zoran; Margeta, Dunja; Matijašić, Gordana; Mintas, Mladen; Molnar, Maja; Ocelić Bulatović, Vesna; Omanović, Saša; Oreščanin, Višnja; Planinić, Mirela; Prlić, Ivica; Rađenović, Ankica; Šabanović, Marizela; Sofilić, Tahir; Ugrina, Marin; Ujević Andrijić, Željka; Veinović, Želimir; Vukojević Medvidović, Nediljka; Vuković Domanovac, Marija

All pieces of information provided in this *Proceedings* are the sole responsibility of the authors of the manuscripts. Publishers are not responsible for any use that might be made of the data appearing in this document. Also, publishers shall not be liable for any errors, language mistakes and the like, that are found in the works of authors.

Pokrovitelj:

Hrvatska akademija znanosti
i umjetnosti
Razred za matematičke,
fizičke i kemijske znanosti

Under the Auspice of:

*Croatian Academy of Sciences
and Arts
Department of Mathematical,
Physical and Chemical Sciences*

**Uz potporu:**

Ministarstvo znanosti i
obrazovanja Republike
Hrvatske

Supported by:

*Ministry of Science and
Education of the Republic of
Croatia*



Ministarstvo znanosti i obrazovanja

Ministarstvo poljoprivrede
Republike Hrvatske

*Ministry of Agriculture of the
Republic of Croatia*



Ministarstvo zaštite okoliša i
prirode Republike Hrvatske

*Ministry of Environmental and
Nature Protection*



REPUBLIKA HRVATSKA

MINISTARSTVO ZAŠTITE
OKOLIŠA I PRIRODE

Ministarstvo gospodarstva

Ministry of Economy



REPUBLIKA HRVATSKA

MINISTARSTVO
GOSPODARSTVA

Sveučilište Josipa Jurja
Strossmayera u Osijeku

*Josip Juraj Strossmayer
University of Osijek*



Fakultet kemijskog
inženjerstva i tehnologije
Sveučilišta u Zagrebu

*Faculty of Chemical Engineering
and Technology, University of
Zagreb*



FKITMCMXIX

Vukovarsko-srijemska
županija

Vukovar-Srijem County



Grad Vukovar

City of Vukovar



Veleučilište Lavoslav
Ružička u Vukovaru

*Polytechnic Lavoslav Ružička in
Vukovar*



Hrvatski dom Vukovar

Croatian House Vukovar



JAVNA USTANOVA U KULTURI

HRVATSKIM DOMOM
VUKOVAR

Acknowledgement to reviewers

The Editors of the *Proceedings* of the 16th *Ružička days* extend their deepest gratitude to the following manuscript reviewers who maintained the professional standards of our *Proceedings* of the 16th *Ružička days*:

Ačkar, Đurđica; Babić, Jurislav; Banjari, Ines; Brnardić, Ivan; Bušić, Valentina; Ćosić, Jasenka; Čukelj, Nikolina; Erceg, Matko; Faraguna, Fabio; Flanjak, Ivana; Gašo Sokač, Dajana; Grčić, Ivana; Iličković, Zoran; Jakić, Miće; Jakobek Barron, Lidija; Jokić, Stela; Jašić, Midhat; Jozinović, Antun; Jukić, Ante; Jurinjak Tušek, Ana; Kučić, Dajana; Kurajica, Stanislav; Kurtanjek, Želimir; Lončarić, Ante; Lovrić, Jasna; Mandić, Zoran; Margeta, Dunja; Matijašić, Gordana; Mintas, Mladen; Molnar, Maja; Ocelić Bulatović, Vesna; Omanović, Saša; Oreščanin, Višnja; Planinić, Mirela; Prlić, Ivica; Rađenović, Ankica; Šabanović, Marizela; Sofilić, Tahir; Ugrina, Marin; Ujević Andrijić, Željka; Veinović, Želimir; Vukojević Medvidović, Nediljka; Vuković Domanovac, Marija

All pieces of information provided in this *Proceedings* are the sole responsibility of the authors of the manuscripts. Publishers are not responsible for any use that might be made of the data appearing in this document. Also, publishers shall not be liable for any errors, language mistakes and the like, that are found in the works of authors.

Pokrovitelj:

Hrvatska akademija znanosti
i umjetnosti
Razred za matematičke,
fizičke i kemijske znanosti

Under the Auspice of:

*Croatian Academy of Sciences
and Arts
Department of Mathematical,
Physical and Chemical Sciences*

**Uz potporu:**

Ministarstvo znanosti i
obrazovanja Republike
Hrvatske

Supported by:

*Ministry of Science and
Education of the Republic of
Croatia*



Ministarstvo znanosti i obrazovanja

Ministarstvo poljoprivrede
Republike Hrvatske

*Ministry of Agriculture of the
Republic of Croatia*



Ministarstvo zaštite okoliša i
prirode Republike Hrvatske

*Ministry of Environmental and
Nature Protection*



Ministarstvo gospodarstva

Ministry of Economy



Sveučilište Josipa Jurja
Strossmayera u Osijeku

*Josip Juraj Strossmayer
University of Osijek*



Fakultet kemijskog
inženjerstva i tehnologije
Sveučilišta u Zagrebu

*Faculty of Chemical Engineering
and Technology, University of
Zagreb*



Vukovarsko-srijemska
županija

Vukovar-Srijem County



Grad Vukovar

City of Vukovar



Veleučilište Lavoslav
Ružička u Vukovaru

*Polytechnic Lavoslav Ružička in
Vukovar*



Hrvatski dom Vukovar

Croatian House Vukovar



Dear colleagues,

In front of you are the Proceedings of the International Conference 16th Ružička days: „Today Science – Tomorrow Industry“ that was held in Vukovar, Croatia at September 21-23, 2016. The main goal of this interdisciplinary conference is to promote excellence in science and engineering as well as application of up-to-date research results and technological achievements in industry. In its fourth issue (2011, 2013, 2015, 2017) the Proceedings continues with publishing of quality scientific and professional full papers in sections Chemical Analysis and Synthesis (3), Chemical and Biochemical Engineering (8), Food Technology and Biotechnology (8), Medical Chemistry and Pharmacy (3), Environmental Protection (11) and Meeting of Young Chemists (2). The open lecture is devoted to Nikola Pšenica, not so known Croatian chemist, which deserves much of the credit for the initial development of chemical industry in Croatia and for promotion of chemistry and chemical engineering in his time. All the papers were thoroughly reviewed from respectable evaluators, to whom we express our gratitude. We are also thankful to all the authors and participants of the Ružička days, and to all that support and contribute in its organization; especially our international coorganizers EuCheMS, EFFoST and EHEDG, the members of organizing and scientific committee, plenary and invited lecturers, sponsors, and of course our highly skilled and committed associates, which put a lot of effort in preparation of this book.

We are looking forward to meeting you all again in Vukovar, in 2018.

Drago Šubarić

Ante Jukić

Editors

Uvodno izlaganje
Open lecture

Srećko Tomas, Ante Jukić, Ivan Hubalek
Vukovarac Nikola Pšenica i Nobelovac Ružička
Nikola Pšenica and Nobel laureate Ružička..... 1

Sekcija: Kemijska analiza i sinteza
Session: Chemical Analysis and Synthesis

Marina Pišonić, Anamarija Šter, Martina Medvidović-Kosanović
Electrochemical characterization of rutin in different electrolytes 19

**Valerija Bukvić, Sunčica Čoklica, Darko Kantoci, Jasmina Ranilović,
Vesna Popijač, Tanja Paveli**
Optimizacija HPLC metode određivanja sadržaja vitamina
Optimization of HPLC method for determination of vitamin content 25

Jelena Klenkar
Primjena antiretrovirusne terapije u liječenju infekcija uzrokovanih virusom HIV-om
Application of antiretroviral therapy in HIV caused infections 36

Sekcija: Kemijsko i biokemijsko inženjerstvo
Session: Chemical and Biochemical Engineering

Antonija Kaćunić, Marija Ćosić, Nenad Kuzmanić
Utjecaj parametara miješanja na utrošak snage u kristalizatoru s dvama
aksijalnim turbinskim miješalima
Influence of mixing parameters on power consumption in dual axial impeller crystallizer..... 51

**Anamarija Mitar, Jasna Prlić Kardum, Aleksandra Sander,
Ivana Radojčić Redovniković**
Fizikalna svojstva prirodnih eutektičkih smjesa
Physical properties of natural deep eutectic solvents 62

Branka Gotovac, Antonija Kaćunić, Davor Rušić
Matematičko modeliranje uzgoja morskih mikroalgi
Mathematical modeling of marine micro-algae cultivation 74

Kristina Zagajski Kučan, Marko Rogošić, Aleksandra Sander Primjena ionskih kapljevine i eutektičkih otapala u ekstrakcijskoj desulfurizaciji i denitrifikaciji The use of ionic liquids and deep eutectic solvents in extractive desulfurization and denitrification.....	86
Marina Duplančić, Kristina Babić, Vesna Tomašić, Zoran Gomzi Catalytic performance of mixed Mn-M (M: Fe, Ni, Cu) oxides in toluene oxidation.....	98
Stjepan Džalto, Fabio Faraguna, Zoran Glasovac, Ante Jukić Sinteza biodizela iz otpadnog suncokretovog ulja i butanola uz gvanidinski katalizator Biodiesel synthesis from waste sunflower oil and butanol by using guanidine catalyst	109
Kristina Babić, Marina Duplančić, Vesna Tomašić, Nikola Milosavljević, Ana Peršić Comparison of the powder and monolithic Mn-Ni catalyst in toluene combustion	120
Katarina Mužina, Mirna Vujnović, Mirela Leskovic Utjecaj pčelinjeg voska na toplinska svojstva biorazgradljivih polimera i njihovih mješavina Influence of beeswax on the thermal properties of biodegradable polymers and their blends.....	133
Sekcija: Prehrambena tehnologija i biotehnologija <i>Session: Food Technology and Biotechnology</i>	
Lidija Jakobek, Petra Krivak, Martina Medvidović Kosanović, Anamarija Šter Dihydrochalcones in old apple varieties from Croatia	146
Maja Benković, Ana Belščak-Cvitanović, Tamara Jurina, Davor Valinger, Ana Jurinjak Tušek, Marija Jakelić, Jasenka Gajdoš Kljusurić Effect of extraction conditions on extraction yield, total polyphenolic content and antioxidant capacity of yarrow (<i>Achillea millefolium L.</i>).....	155
Marina Palfi, Vesna Mihaljević-Herman, Jasenka Ćosić, Vesna Popijač, Nina Puhač Bogadi <i>In vitro</i> antibacterial activity of essential oils on <i>Staphylococcus aureus</i> and <i>Escherichia coli</i>	163
Ksenija Durgo, Arijana Bušić, Aleksandra Vojvodić, Ana Belščak-Cvitanović, Marina Lisičar, Draženka Komes Cytotoxic and prooxidative effect of ginger extract on human laryngeal and lung carcinoma cell lines	170
Jana Šic Žlabur, Sandra Voća, Nadica Dobričević, Sanja Fabek, Antonija Franjić, Ante Galić, Stjepan Pliestić Nutritional composition of garlic from organic and conventional cultivation	182

Davor Valinger, Tamara Jurina, Maja Benković, Ana Jurinjak Tušek, Ana Belščak-Cvitanović, Marija Jakelić, Jasenka Gajdoš Kljusurić Determination of correlations between electrical conductivity, dry matter, total polyphenolic content and antioxidant capacity of marigold extracts (<i>Calendula officinalis</i>)	189
Ana Belščak-Cvitanović, Ana Jurinjak Tušek, Davor Valinger, Maja Benković, Tamara Jurina, Draženka Komes Application of artificial neural networks (ANNs) for development of HPLC gradient separation methods of polyphenolic compounds in medicinal plants	198
Natalija Uršulin-Trstenjak, Davor Levanić, Josip Halamić, Ajka Šorša, Želimira Cvetković, Jasenka Šabarić, Danijel Brkić The correlation of mineral elements shares in the soil and black locust honey within five Croatian regions and seasons	209

Sekcija: Medicinska kemija i farmacija
Session: Medical Chemistry and Pharmacy

Irena Landeka Jurčević, Domagoj Đikić, Vedran Balta, Ivona Paradžik, Lea Sabljic Utjecaj flavonoida iz cvijeta <i>Prunus spinosa L.</i> i Whey proteina na oksidacijsko/antioksidacijski status u C57BL/6 miša Effect of Flavonoids from flowers of <i>Prunus spinosa L.</i> and Whey protein to oxidation/ antioxidant status in the C57BL/6 mouse	225
Irena Landeka Jurčević, Monika Fumić, Domagoj Đikić, Verica Dragović-Uzelac, Sandra Pedisić, Zoran Zorić Biodostupnost antocijana iz pokožice crnog grožđa u serumu C57BL/6 miša The bioavailability of anthocyanins from the skins of red grapes in the serum of C57BL/6 mouse	239
Ana Belščak-Cvitanović, Eva Maria Theismann, Arijana Bušić, Aleksandra Vojvodić, Julia Keppler, Anja Steffen-Heins, Draženka Komes Development of protein-polysaccharide complex Hydrogel particles encapsulating model polyphenolic antioxidants.....	250

Sekcija: Zaštita okoliša
Session: Environmental Protection

Dajana Kučić, Denija Krivičić, Felicita Briški Obrada otpadne vode iz procesa proizvodnje maslinovog ulja postupcima adsorpcije i biosorpcije Olive mill wastewater treatment by adsorption and biosorption processes.....	262
---	-----

Sadržaj / Contents

Dijana Grgas, Tea Širac, Morena Prodan, Andrijana Brozinčević, Tibela Landeka Dragičević Denitrifikacija: Učinak omjera C/N Denitrification: The effect of C/N ratio	277
Luči Veljačić, Anamarija Veljačić, Ante Mrčela Održivi razvoj gospodarenja otpadom kroz mjere upravljačkog nadzora Sustainable development waste management through control measures	289
Natalija Velić, Hrvoje Pavlović, Mirjana Pavičić, Antonija Kezerle Obezbojenje sintetskih bojila na agarnim pločama odabranim gljivama Synthetic dyes decolourisation on agar plates by selected fungi.....	295
Marin Ugrina, Nediljka Vukojević Medvidović, Marina Trgo, Ivona Nuić Iron-modified zeolite as a sorbent for nitrate and phosphate removal from water systems.....	302
Marjana Simonič, Lidija Fras Zemljič Heavy metals removal from compost leachate using zeolite.....	311
Monika Šabić, Petra Vukić, Marija Vuković Domanovac, Ernest Meštrović Kinetika biosorpcije u obradi farmaceutskih otpadnih voda Biosorption kinetics in pharmaceutical wastewater treatment	317
Nada Pitinac, Marija Dundović, Đurđevka Pecikozić, Bruno Zelić Monitoring of physical and chemical water quality parameters in the Danube – Drava rivers flood area.....	326
Tihana Marček, Marija Viljevac Vuletić, Sara Alivojvodić, Ivan Bakula, Valentina Španić Antioxidative response of wheat genotypes under <i>Fusarium</i> spp. infestation	335
Tomislav Domanovac, Marija Vuković Domanovac Centri za ponovnu uporabu u funkciji zaštite okoliša The reuse centres in environmental protection.....	342
Lidija Fras Zemljič, Marjana Simonič, Olivera Šauperl, Rok Mihelić The possibility of using treated compost leachate as hydroponic solution.....	353

Susret mladih kemičara
Meeting of Young Chemists

Tomislav Jozinović, Maja Stojanović

Sadržaj vitamina C u malinama s područja općine Žepče

The vitamin C content in raspberries from the municipality of Žepče 360

Kristina Šimić, Slavica Jukić

Tvrdoća vode u općini Žepče

Hardness of water in the municipality of Žepče..... 377

Kazalo autora

Author Index 387

Sponzori, donatori i izlagači

Sponsors, donors and exhibitors 390

Vukovarac Nikola Pšenica i Nobelovac Ružička

Nikola Pšenica and Nobel laureate Ružička

Srećko Tomas¹, Ante Jukić², Ivan Hubalek³

¹Sveučilište J. J. Strossmayera u Osijeku, Prehrambeno-tehnološki fakultet,
F. Kuhača 20, 31 000 Osijek, Hrvatska

²Sveučilište u Zagrebu, Fakultet kemijskog inženjerstva i tehnologije,
Marulićev trg 19, 10 000 Zagreb, Hrvatska

³Miroslava Krležje 24, 31 207 Tenja, Hrvatska (u mirovini, bivši djelatnik "Borovo" Vukovar)

UVOD



DR. ING. NIKOLA PŠENICA

Jedan od znamenitih Vukovaraca o kojem se nedovoljno zna je dr. ing. Nikola Pšenica, suvremenik slavnoga nobelovca Leopolda Lavoslava Ružičke. Naime N. Pšenica je rođen u Vukovaru 1887., tj. iste godine kada i Ružička. Osnovnoškolsko i srednjoškolsko obrazovanje obavio je u Vukovaru, Osijeku i Zemunu, gdje je maturirao 1907.¹ Diplomirao je inženjersku kemiju 1913., na Visokoj tehničkoj školi u Beču. Doktorirao je 1921. na toj istoj visokoj školi, nakon čega je, iste godine, imenovan profesorom organske tehnologije na zagrebačkoj tehničkoj visokoj školi. No, ubrzo je dao ostavku na profesorsko zanimanje. Naime, postao je tehnički savjetnik Prve hrvatske štedionice. U tom svojstvu je modernizirao i proširio Tvornicu papira na Sušaku, tako da je postala jednom od najbolje uređenih tvornica za izradu finih papira u Europi.

Također je Vukovarsku kudjeljaru i predionicu d. d. proširio i bio joj dugo godina članom uprave. Od samog osnutka Jugoslavenskog hemijskog društva, Sekcije u Zagrebu, 1926., bio je njegov aktivni član, da bi 31. ožujka 1939. postao i predsjednikom toga društva. Odmah se novi predsjednik N. Pšenica zauzeo da to društvo dobije hrvatsko ime, tako da je od 5. studenog 1939. promijenilo ime u *Hrvatsko kemijsko društvo (HKD)*. Iste godine zahvaljujući svojim dobrim vezama s kemijskom industrijom, uspio je Pšenica osigurati solidne donacije HKD-u, što mu je omogućilo bogate aktivnosti. Na mjestu predsjednika *Hrvatskog kemijskog društva* ostao je do 20. rujna 1942. Poslije drugog svjetskog rata Pšenica je postao tehnički savjetnik Glavne direkcije lana i konoplje. No, zbog pojave teške i dugotrajne bolesti preminuo je 29. kolovoza 1950.² Druga, vjerojatno i najznačajnija zasluga predsjednika Pšenice i cijelog *Hrvatskog kemijskog društva* je što je, nakon što je Ružička, kao prvi Hrvat dobio Nobelovu nagradu za kemiju, organizirao Ružičkin dolazak i boravak u Zagrebu od 15. do 20. ožujka 1940., pri čemu je održana veličanstvena proslava tog događaja. Bila je to po općenitoj prosudbi najveća kulturna priredba ikada do tada održana u Zagrebu i Hrvatskoj.

¹ Realna gimnazija u Zemunu - Glavni imenik VIII. razreda školske godine 1906./07., red. br. 21 (signatura IAB-270- inv.br. 24-r. br. 21-glavni imenik za školsku godinu 1906./07.)

² Stanko MIHOLIĆ – NEKROLOG: Dr. ing. Nikola Pšenica, *Arhiv za kemiju*, God. XXIII. (1951.), br. 1. i 2., str. 35. – 36.

Prema prijavi *Časnom Meštarskom Zboru družbe Braće Hrvatskog Zmaja u Zagrebu*, (Broj 226/1939.) koja je popunjena 15. rujna 1939.,³ saznaje se da se Nikola Pšenica rodio 30. studenog 1887. u Vukovaru, od oca Josipa Pšenice i majke Marije, rođene Gjurković. Prijava je popunjena sa željom da dr. ing. Nikola Pšenica pristupi uglednoj družbi *Braća Hrvatskog Zmaja (BHZ)*, kao redovni član. Za zanimanje je Pšenica naveo da je inženjer Prve hrvatske štedionice, za imendan 6. prosinca, a za vjeroispovijest *rimo-katoličku*. U istoj prijavi unesen je i podatak o bračnom stanju, tj. da se oženio 2. kolovoza 1922., i to Marijom, rođenom Ficek. Imali su dvije kćerke, i to Juditu, rođenu 8. srpnja 1923. i Renatu, rođenu 11. listopada 1925. Nadalje je naveo da je bio član Društva Srijemaca u Zagrebu, Društva prijatelja Njemačke u Zagrebu, Društva prijatelja talijanske knjige u Zagrebu, Kemijskog društva u Zagrebu i Matice Hrvatske u Zagrebu. Također je Pšenica upisao svoju adresu stanovanja u Zagrebu, a to je Bosanska ul. 15a i da mu je telefon bio 94-71, što je svojeručno i potpisao. Ovu zamolbu potpisala su i preporučila dr. ing. N. Pšenicu za prijem u družbu *BHZ*, dvojica članova te ugledne udruge, *Zmaj Ružičin* i *Zmaj Pleternički*.

Za školovanje je dr. ing. Pšenica naveo da je završio realnu gimnaziju, te Visoku tehničku školu u Beču i Doktorat tehničkih znanosti Visoke tehničke škole u Beču. Služba mu je bila tehnički savjetnik i prokurista Prve hrvatske štedionice, a bio je tada i predsjednik kemijskog društva u Zagrebu. Za rad na književnom, umjetničkom ili drugom kojem kulturnom polju, naveo je rad na znanstvenom i industrijsko-tehničkom polju. Zanimljivo je da se u prijavi za članstvo u družbi *BHZ*, tražilo i očitovanje o književnom ili umjetničkom pseudonimu, gdje je Pšenica naveo *Dr. N-1*. U *Osvrtu na pređe i uspomene iz djetinstva, te osobiti događaji iz života*, naveo je Pšenica za majku da je rođena Gjurković, baka da je rođena Rogić i prabaka da je rođena Lužević; zatim da mu je otac Josip i djed Vjenceslav, a za pradjeda nije naveo ime. Rukom je na prvoj stranici prijave upisano da je I. čitanje obavljeno 27. IX. 1939., II. čitanje obavljeno 4. X. 1939. i III. čitanje obavljeno je 25. X. 1939. No, na zadnjoj stranici, gdje je trebalo biti upisano kada je primljen u družbu *BHZ*, nema podataka, pa se može zaključiti da nije bio primljen u tu udruhu.

PRVI PREDsjedNIK HRVATSKOG KEMIJSKOG DRUŠTVA

U Zagrebu je 23. siječnja 1926. osnovano Jugoslovensko hemijsko društvo (JHD), Sekcija Zagreb, a prvi predsjednik je bio dr. Vladimir Njegovan. Interesantno je da je među redovitim članovima toga društva, upisan pod rednim brojem 87., prof. dr. inž. kem. Lavoslav Ružička s Kem. Instit. Universiteta u Utrechtu iz Nizozemske.³ U časopisu *Arhiv za hemiju i farmaciju*, izišlom u lipnju 1927., objavljen je članak pod naslovom „Jugoslovensko hemijsko društvo – Sekcija Zagreb“, u kojem je navedeno da je Odbor Jugoslovenskog hemijskog društva (JHD) primio nove članove, a među njima je, pod rednim brojem 121., kao redoviti član, upisan dr. ing. Nikola Pšenica iz Zagreba, ulica Račkoga 21. Inače je ta zagrebačka sekcija koncem lipnja 1927. imala 124 redovita i 27 izvanrednih članova.⁴ Prema „Zapisniku prve glavne skupštine Jugoslovenskog Hemijskog Društva u Zagrebu, održane 9. marta 1929. u maloj predavaonici hemijskog instituta na Mažuranićevom trgu 29.“, na toj skupštini bio je nazočan i dr. ing. N. Pšenica.⁵

³ „Jugoslovensko hemijsko društvo – Sekcija Zagreb“, *Arhiv za hemiju i farmaciju*, God. I. (1927.), br. 1., str. 41 – 47.

⁴ Vladimir NJEGOVAN, Rikard PODHORSKY - „Jugoslovensko hemijsko društvo – Sekcija Zagreb“, *Arhiv za hemiju i farmaciju*, God. I. (1927.), br. 3., str. 141. – 142.

⁵ „Zapisnik prve glavne skupštine Jugoslovenskog Hemijskog Društva u Zagrebu, održane 9. marta 1929. u maloj predavaonici hemijskog instituta na Mažuran. trgu 29.“, *Arhiv za hemiju i farmaciju*, God. III. (1929.), br. 2., str. 95.

U *Arhivu za kemiju i tehnologiju*, god. XIII., (1939.), br. 1., kojeg je izdavač bilo Hrvatsko kemijsko društvo, Zagreb, Marulićev trg 20, te kojem je glavni urednik bio prof. dr. F. Hanaman, nalazi se i rubrika „Društvene vijesti“, u kojoj je objavljen zapisnik s XI. glavne skupštine Jugoslavenskog hemijskog društva, održanoj 31. ožujka 1939. u prostorijama Udruženja Jugoslavenskih inženjera i arhitekata u Zagrebu, Jelačićev trg 1/III. Nazočni su bili: Brichta, Corubolo, Grubić, Hahn, Hanaman, Iveković, Karšulin, Krajovan, Krajovan-Marjanović, Kolbach, Lorković, Mudrovčić, Mundorfer, Orlić, Piantanida, Podhorsky, **Prelog, Pšenica**, Rado, Rechnitzer A., Smolčić, Šarić, Težak, Trinajstić, Váry, Verlić i Žerdik. Na toj skupštini prema prijedlogu upravnog odbora kojeg je pročitao prof. dr. ing. Podhorsky izabrala je skupština, jednoglasno, dr. ing. Nikolu Pšenicu za novog predsjednika.⁶

Nadalje u *Arhivu za kemiju i tehnologiju*, god. XIII., (1939.), br. 3.–6., u rubrici „Društvene vijesti“, objavljen je zapisnik sa znamenite izvanredne godišnje skupštine Jugoslavenskog hemijskog društva, održane 5. studenoga 1939., u maloj predavaonici Kemijskog instituta Tehničkog fakulteta u Zagrebu, Marulićev trg 20. Izvješće je podnio predsjednik dr. ing. Nikola Pšenica. Naglasio je da je svrha te izvanredne skupštine, ponajprije u težnji da se *poradi na ponovnom okupljanju svih kemičara s teritorija Banovine Hrvatske, na što užu i korisniju zajedničku suradnju i da se u odnosnim dogovorima utvrde i odrede putevi, na koji će se najbolji način moći rješavati razna aktualna pitanja, koja (nas) sve zanimaju*. Govoreći o prijedlogu o promjeni Pravila Društva, Pšenica je istaknuo: „Prihvati li ova glavna skupština predložena društvena Pravila skopčana sa izmjenom sadašnjeg društvenog imena, **to će se po prvi puta u povijesti našeg naroda ostvariti »Hrvatsko kemijsko društvo«**.“ Još je dodao da će novo-usvojena Pravila biti predložena na odobrenje banskoj vlasti Banovine Hrvatske. Nakon uvodnog izlaganja predsjednika Pšenice i provedene rasprave, odlučeno je da se promijene Pravila društva i prihvati novo ime.⁷ U *Arhivu za kemiju i tehnologiju*, objavljen je i zapisnik sa glavne godišnje skupštine Hrvatskog kemijskog društva, održane dne 28. siječnja 1940., u maloj predavaonici Kemijskog instituta u Zagrebu, Marulićev trg 20. Budući da je ta glavna skupština imala izborni karakter, birana su sva potrebna tijela društva, a za predsjednika je ponovo izabran dr. ing. Nikola Pšenica. Nadalje, stoji u zapisniku: „U daljnjoj točki dnevnog reda izvještava predsjednik skupštinu o konstituiranju Odbora kulturnih i stručnih društava i nadležtava za svečani doček i boravak dra Lavoslava Ružičke, člana H. K. D. u Zagrebu. Na prijedlog odbora, koji iznosi predsjednik, glavna skupština jednoglasno i dugom aklamacijom bira dra Lavoslava Ružičku, profesora na visokoj tehničkoj školi u Zürichu, **prvog Hrvata dobitnika Nobelove nagrade, za svog prvog počasnog člana**. Povelja počasnog članstva predat će se dru Ružički prilikom njegovog boravka u Zagrebu na svečan način.“⁸

Nakon II. svjetskog rata, 3. siječnja 1946. održana je glavna godišnja skupština Hrvatskog kemijskog društva, na kojoj nisu bili nazočni ni prethodni predsjednik, a niti potpredsjednik dr. ing. N. Pšenica, jer vjerojatno nisu bili niti pozvani, kao čelni ljudi društva u vrijeme NDH. Skupštinu je otvorio R. Podhorsky, a izvješće je podnio prethodni tajnik Iveković, no ni on nije spomenuo bivšeg predsjednika i potpredsjednika društva dr. ing. N. Pšenicu.⁹

⁶ „Društvene vijesti“ *Arhiv za kemiju i tehnologiju*, god. XIII., (1939.), br. 1., str.67. – 72.

⁷ „Društvene vijesti“ *Arhiv za kemiju i tehnologiju*, god. XIII., (1939.), br. 3. – 6., str.157. – 162.

⁸ „Društvene vijesti“ *Arhiv za kemiju i tehnologiju*, god. XIII., (1939.), br. 3. – 6., str.162. – 168.

⁹ „Glavna godišnja skupština Hrvatskog kemijskog društva, *Arhiv za kemiju*, God. XVIII. (1946.), str. 123. – 127.

U članku „Glavna godišnja skupština Hrvatskog kemijskog društva za godinu 1952.“, navedeno je da se ta skupština održala 26. ožujka 1952.¹⁰ Za primijetiti je, da je to bila prva godišnja skupština HKD-a, nakon smrti dr. ing. N. Pšenice, za vrijeme čijeg predsjednikovanja je tom društvu promijenjeno ime JHD-a u HKD, te koji je bio najzaslužniji za velebni uspjeh Ružičkine proslave dobitka Nobelove nagrade u Zagrebu, od 15. do 20. ožujka 1940., a da ni jednom riječi nije spomenut, niti da mu je održana počast minutom šutnje?!

ULOGA DR. ING. NIKOLE PŠENICE U ORGANIZACIJI RUŽIČKINE PROSLAVE DOBITKA NOBELOVE NAGRADE U ZAGREBU, 15. – 20. OŽUJKA 1940.

Nikola Pšenica je napisao članak pod naslovom „Boravak prof. dra. Lavoslava Ružičke u Zagrebu od 15.-20. III. 1940.“,¹¹ prema kojem proizlazi da je tadašnji predsjednik Hrvatskog kemijskog društva u Zagrebu, dr. ing. Nikola Pšenica uputio 30. studenog 1939. dr. Ružički, u pisanom obliku, čestitke na dobivanju Nobelove nagrade. Ujedno je, po spoznaji da su, radi započetog rata otpale svečanosti podjeljivanja Nobelove nagrade u Stockholmu, predložio dr. Ružički, da u predviđenom roku od 6 mjeseci održi svoje Nobelovo predavanje u Zagrebu i da se na taj način jedan dio propisane stokholmske svečanosti održi u Zagrebu. Dr. Ružička mu je odgovorio 5. prosinca 1939., prihvaćajući u načelu poziv da održi Nobelovo predavanje u Zagrebu, ali je izrazio želju, da održi skupno predavanje za sve znanstvene i stručne ustanove u Zagrebu, jer da je i s jedne druge strane dobio sličan prijedlog. Pšenica je odmah pristupio pripremnim radovima. Kao temelj svega inicirao je, što je i s oduševljenjem prihvaćeno, imenovanje »Odbora znanstvenih i stručnih ustanova i društava za doček i boravak Dra Lavoslava Ružičke u Zagrebu«, u sastavu: **Dr. Ing. Nikola Pšenica**, predsjednik HKD-a; **predsjednik; Dr. Albert Bazala**, predsjednik JAZU-a; **Dr. Andrija Živković**, sveučilišni profesor i rektor; **Dr. Slavko Babić**, odjelni savjetnik i tajnik bana dr. Ive Šubašića; **Dr. Mato Starčević**, povjerenik za grad Zagreb; **Dr. Vladimir Čepulić**, predsjednik Zbora hrvatskih liječnika; **Dr. Stjepan Škreb**, predsjednik Hrvatskog prirodoslovnog društva; **Mr. Josip Taborski**, predsjednik Hrvatskog farmaceutskog društva; **Ing. Radoslav Lorković**, predsjednik Kluba inženjera kemije; **Dr. Branimir Sokolić**, predsjednik Hrvatskog novinarskog društva; **Dr. Stanko Hondl**, potpredsjednik JAZU-a; **Mr. Krešimir Fibić**, potpredsjednik Hrvatskog ljekarničkog društva; **Izidor Škorjač**, odjelni predstojnik za prosvjetu; **Dr. Ing. Hrvoje Iveković**, tajnik Hrvatskog kemijskog društva; **Dr. Zvonimir Vinković**, tajnik radničke komore; **Dr. ing. Franjo Hanaman**, glavni urednik *Arhiva za kemiju i tehnologiju*; **Dr. Vladimir Varićak**, sveučilišni profesor; **Dr. Boris Zarnik**, sveučilišni profesor.¹²

Uočava se da je dr. Pšenica okupio u taj Odbor zaista reprezentativne članove iz političkog, znanstvenog, stručnog i općedruštvenog miljea tadašnjeg Zagreba, glavnog grada Banovine Hrvatske. No, trebalo se zdušno prihvatiti posla, što je Pšenica i učinio, a o tome svjedoče i brojni novinski članci i vijesti. Uostalom, u svom Odboru imao je kao člana dr. Branimira Sokolića, predsjednika Hrvatskog novinarskog društva, što se pokazalo izvrsnim potezom, jer su, uz

¹⁰ „Glavna godišnja skupština Hrvatskog kemijskog društva za godinu 1952.“, *Arhiv za kemiju*, God. XXIV. (1952.), str. 11. – 19.

¹¹ Nikola PŠENICA - Boravak prof. dra. Lavoslava Ružičke u Zagrebu od 15.-20. III. 1940., *Kemijski vjestnik (Arhiv za kemiju i tehnologiju)*, God. XV i XVI. (1941.-42.), str. 92. – 126.

¹² Nikola PŠENICA - Boravak prof. dra. Lavoslava Ružičke u Zagrebu od 15.-20. III. 1940., str. 100. – 101.

očekivane članke u stručnim časopisima, objavljeni i u različitim novinskim listovima, brojni članci o prvom hrvatskom nobelovcu, a napose o svečanostima održanim u Zagrebu od 15. – 20. ožujka 1940. Naime, u razdoblju od studenoga 1939. do svibnja 1940., na prostorima tadašnje Kraljevine Jugoslavije, što se do sada uspjelo pronaći, objavljeno je na tu temu ukupno 87 članaka, većeg ili manjeg opsega, što je zaista za to doba impozantan broj i nevjerojatan uspjeh popularizacije, inače medijski često manje zanimljivih znanstvenika i znanosti kojom se bave.

Tako je Mladen Deželić, odmah po saznanju da je dr. Ružička dobio Nobelovu nagradu za kemiju, priredio i objavio u *Arhivu za kemiju i tehnologiju*, članak pod naslovom „Prof. L. Ružička i njegov rad“.¹³ U istom časopisu, koji je u vrijeme NDH promijenio ime u *Kemijski vjesnik*, objavio je i N. Pšenica svoj već spomenuti članak. U *Liječničkom vjesniku* objavljena su tri članka, od kojih su dva nepotpisana. Pri tome je pogrešno navedeno da je Ružičkino ime Ladislav.¹⁴ U časopisu *Ars therapeutica*, objavljeno je šest članaka.¹⁵ U časopisu *Inženjer*, glasilu Saveza inženjerskih društava Kraljevine Jugoslavije, objavljene su informacije o dodjeli Nobelove nagrade dr. Ružički i njegovom boravku u Zagrebu od 15. do 20. ožujka 1940., u dva članka.¹⁶

U *Nastavnom vjesniku* objavljen je jedan članak, autora Mladena Deželića, pod naslovom „Prof. Lavoslav Ružička – Prvi Hrvat, koji je dobio Nobelovu nagradu“. Deželić navodi u članku podatke iz životopisa prof. Ružičke, pri čemu je naveo da je biografske podatke dobio od prof. L. Ružičke i njegove gospođe Ane, a djelomično su prikupljeni od dr. ing. Nikole Pšenice, predsjednika Hrvatskog (kemijskog) društva, koji je organizirao s velikim uspjehom doček i boravak prof. Ružičke u Zagrebu.¹⁷ Časopis *Hrvatska revija*, kojeg izdaje Matica Hrvatska, objavio je vijest o dodjeli Nobelove nagrade prof. Ružički, pod naslovom „Podjela Nobelove nagrade za kemiju“. Pri tome je pogrešno naveo da je Ružičkino ime Ladislav.¹⁸ Autor potpisan s Pg¹⁹ napisao je članak pod naslovom „Profesor Lavoslav Ružička“ u *Savremeniku*, kojeg je izdavalo Društvo hrvatskih književnika.²⁰ Prema broju objavljenih članaka i vijesti, najplodonosnije bile su *Novosti*, zagrebački dnevni list, koje su objavile ukupno 17 članaka.²¹

¹³ Mladen DEŽELIĆ - Prof. L. Ružička i njegov rad, *Arhiv za kemiju i tehnologiju*, God. XIII. (1939.), br. 3-6, str. 73. – 97.

¹⁴ ** Predavanje g. prof. Ladislava (Očiti tipfeler, op. a.) Ružičke u Zagrebu, *Liječnički vjesnik*, God. LXII. (1940.), br. 1., str. 51.; ** Proslava prof. dra Lavoslava Ružičke prvog Hrvata dobitnika nobelove nagrade, *Liječnički vjesnik*, God. LXII. (1940.), br. 4., str. 236. – 237.; ** Lavoslav RUŽIČKA – Od dalmatinskog buhača do seksualnih hormona, *Liječnički vjesnik*, God. LXII. (1940.), br. 7., str. 329. – 335.

¹⁵ ** UREDNIŠTVO – „Prigodom predavanja Nobel-laureata gosp. prof. Dra L. Ružičke“, *Ars therapeutica*, god. XIII, (1940.), br. 1-2., str. 1.; ** „Prof. Dr. Lavoslav Ružička“, *Ars therapeutica* XIII, (1940.), 1-2., str. 2. -3.; ** P. J. JURISIĆ - Od A. A. Berthold-a do sinteze spolnih hormona – Povodom predavanja Nobellaureata prof. dra L. Ružičke, *Ars therapeutica* XIII, (1940.), 1-2., str. 4. – 9.; ** Stanka ŠPLAIT – „Svečana razdioba Nobelovih nagrada“, *Ars therapeutica* XIII, (1940.), 1-2., str. 28. – 31.; ** „Nosioci Nobelove nagrade“, *Ars therapeutica* XIII, (1940.), 1-2., str. 31. – 34.; ** „Slaveni Nobelovci“, *Ars therapeutica* XIII, (1940.), 1-2., str. 34.– 40.

¹⁶ „Društvene vijesti: Društvo inženjera u Zagrebu“, *Inženjer*, God. I., (1940.), br. 1 – 2, str. 7. – 8.; ** „62. Glavna godišnja skupština sekcije Zagreb UJIA, 14. travnja 1940. god. (2. Izbor dr. ing. Lavoslava Ružičke za začasnog člana)“, *Inženjer*, God. I., (1940.), br. 3 – 4, str. 19.

¹⁷ Mladen DEŽELIĆ – Prof. Lavoslav Ružička – Prvi Hrvat, koji je dobio Nobelovu nagradu, *Nastavni vjesnik*, God. XLVIII. (1939 – 1940), br. 6., str. 395. – 407.

¹⁸ Podjela Nobelove nagrade za kemiju, *Hrvatska revija*, God. XIII. (MCMXL), br. 3., str. 161.

¹⁹ Za pretpostaviti je da je to dr. Vladimir Prelog.

²⁰ Pg - Profesor Lavoslav Ružička, *Savremenik*, God. XXVIII., (1940.), br. 6., str. 184.

²¹ ** Goleme stručne zasluge i priznanja Nobelovom nagradjeniku Prof. dr. Ing. Lavoslavu Ružički iz Vukovara – Predavanje dra M. Deželića u Pučkom sveučilištu u Zagrebu, *Novosti*, god. XXXIII., br. 348, 17. XII. 1939., str. 15.; ** ENES (Niko Smolčić) - Prvi Hrvat odlikovan Nobelovom nagradom Dr. Ružička održat će na našem jeziku u Zagrebu predavanje, koje je trebao održati na otkazanoj svečanoj sjednici u Stockholmu, *Novosti*, god. XXXIV., br. 44, 14. II. 1940., str. 12.;

Uvodno izlaganje / Open lecture

U članku pod naslovom: „Sav kulturni Zagreb s ushićenjem prima u svoju sredinu svog slavnog zemljaka Hrvata, naučenjaka prof. Dra Lavoslava Ružičku. Kakve su sve počasti dosad podijeljene dobitniku Nobelove nagrade“, Enes (Niko Smolčić) objavio je pored niza informacija, koje mu je priredio dr. ing. N. Pšenica, i njegovu fotografiju, Slika 1, ispod koje je objavio da je on kao predsjednik HKD-a izvršio i najveći dio priprema za dolazak i boravak dr. Ružičke u Zagrebu. Nadalje, Smolčić navodi da su *Novosti* mnogo toga već dosada iznijeli o Ružički u objavljenim člancima, ali radi još bolje upotpunjenosti, obratili su se na predsjednika HKD-a dr. ing. N. Pšenicu za daljnje informacije. Time je posvjedočio da su glavne informacije crpili upravo od dr. ing. N. Pšenice.



Članak koji nosi naslov „Prvi naš nosilac Nobelove nagrade prof. Lavoslav Ružička u Zagrebu“, sadrži fotografiju Ružičke iz njegovog laboratorija s njegovom posvetom, kao i fotografije s Ružičkinog dolaska u Zagreb i njegovog susreta s hrvatskim banom dr. Ivanom Šubašićem (Slika. 2). Članak Vladimira Majera – „Kakav je učenjak Dr. Ružička izvan laboratorija - Nobelov laureat govori za „Novosti“ o svom djetinjstvu i školovanju u hrvatskoj, o događajima u vezi s podjelom Nobelove nagrade, o djelovanju seksualnih hormona itd.“, *Novosti*, god. XXXIV., br. 76, 17. III. 1940., str. 2. – 3., opisuje doček Ružičke, na zagrebačkom glavnom kolodvoru.

Slika 1. Dr. ing Nikola Pšenica, u Zagrebu 1940.

** „Zaklada od 100 hiljada dinara zagrebačkom sveučilištu dar je gdje Marije Najpar iz Vukovara“, *Novosti*, god. XXXIV., br. 74, 15. III. 1940., str. 5.; ** ENES (Niko Smolčić) – „Sav kulturni Zagreb s ushićenjem prima u svoju sredinu svog slavnog zemljaka Hrvata, naučenjaka prof. Dra Lavoslava Ružičku. Kakve su sve počasti dosad podijeljene dobitniku Nobelove nagrade“, *Novosti*, god. XXXIV., br. 75, 16. III. 1940., str. 9.; ** ENES (Niko Smolčić) - „Od dalmatinskog buhača do seksualnih hormona“, predavanje Nobelovog laureata Lavoslava Ružičke biti će najveća znanstveno-kulturna priredba do sada u Zagrebu. Uvaženi učenjak, osnivač hrvatskog kemijskog društva, stiže u petak na večer. Vanredne počasti i priznanja jednom velikom čovjeku“, *Novosti*, god. XXXIV., br. 74, 15. III. 1940., 15.; ** Profesor dr. Ružička stigao je u Jugoslaviju - izjava našeg slavnog zemljaka „Novostima“, *Novosti*, god. XXXIV., br. 75, 16. III. 1940., str. 9. – 10.; ** Prvi naš nosilac Nobelove nagrade prof. Lavoslav Ružička u Zagrebu, *Novosti*, god. XXXIV., br. 76, 17. III. 1940., str. 1.; Vladimir MAJER – „Kakav je učenjak Dr. Ružička izvan laboratorija - Nobelov laureat govori za „Novosti“ o svom djetinjstvu i školovanju u hrvatskoj, o događajima u vezi s podjelom Nobelove nagrade, o djelovanju seksualnih hormona itd.“, *Novosti*, god. XXXIV., br. 76, 17. III. 1940., str. 2.–3.; ** F. M. FUIS – „Čovjek, koji je dobio Nobelovu nagradu: Kako je američka štampa proglasila profesora Ružičku tvorcem "vječnog života" - »onaj, koji može pretvoriti „nju“ u „njega“« - razgovor sa velikim naučenjakom, čija je najveća ljubav - rad, najizrazitija vrlina - skromnost, a najmiliji - mir...“, *Novosti*, god. XXXIV., br. 76, 17. III. 1940., str. 3. – 4.; ** „Večera u čast g. prof. dra Lavoslava Ružičke“, *Novosti*, god. XXXIV., broj 76, nedjelja, 17. marta 1940., str. 4.; ** V – „Kulturna manifestacija visokog stila - Predavanje profesora Ružičke: „Drago mi je što ovdje mogu da održim predavanje na svom materinjem jeziku“, *Novosti*, god. XXXIV., br. 76, 17. III. 1940., str. 4.; ** V – „*Doctor honoris causa* dr. Lavoslava Ružička istakao je prilikom svečane promocije vjeru da će naša znanost dati još više lijepih plodova sada, kad su se sve snage hrvatskog naroda ujedinile“, *Novosti*, god. XXXIV., br. 77, 18. III. 1940., str. 5. – 6.; ** ENES (Niko Smolčić) – „Na večeri gradskog povjerenika profesor dr. Ružička je iskazao svu svoju radost i zahvalnost zemljacima“, *Novosti*, god. XXXIV., br. 77, 18. III. 1940., str. 6. – 7.; ** V. – „Profesor Dr. Ružička razgledava zagrebačke kulturne ustanove - Tekst diplome grada Vukovara i počast društva inženjera“, *Novosti*, god. XXXIV., br. 78, 19. III. 1940., str. 9.; ** IS. – „Profesor Ružička među svojim školskim drugovima“, *Novosti*, god. XXXIV., broj 78, 19. III. 1940., str. 9.; ** V – „Laskava izjava prof. Ružičke o hrvatskoj nauci – Nobelov laureat oprostio se od Zagreba i njegovih političkih i kulturnih predstavnika“, *Novosti*, god. XXXIV., br. 80, 21. III. 1940., str. 9.; ** EN. – „Dirljiv rastanak s prof. Ružičkom na odlasku iz Zagreba“, *Novosti*, god. XXXIV., br. 80, 21. III. 1940., str. 9.; ** V – „Kulturna manifestacija visokog stila - Predavanje profesora Ružičke: "Drago mi je što ovdje mogu da održim predavanje na svom materinjem jeziku“, *Novosti*, god. XXXIV., br. 76, 17. III. 1940., str. 4.

Navedeno je da je prvi prišao dr. Ružički predsjednik HKD-a dr. ing. N. Pšenica, pa su ga onda pozdravili i svi ostali koji su ga dočekali. Nakon toga dr. Ružička je izrekao kratku zahvalu i odmah se upustio u razgovor s kolegama, dio kojeg su prenijele *Novosti*:

„- A Pšenica, Pšenica, znam Vas! - rekao je živo - Vaš mi je otac pravio najbolja odijela. A mome je ocu uvijek pričao: »Ružička, ne pij toliko!« Zar ne!

- Tako je bilo! - veselo će dr. Pšenica.

- A ti si bio - obraća se dr. Ružička rektoru dr. Živkoviću - »musterschüller«! Dobro izgledaš. Sjećáš li se, kako je bilo u gimnaziji?

S bolom u srcu i lakim uzdahom, dr. Ružička je na kraju okružio očima cijelom dvoranom i rekao:

- Da, davno je to bilo! A mnogi od onih za koje sam pročitao da će me dočekati, mrtvi su...“

Očito je da su se Ružička i Pšenica dobro poznavali još iz ranog djetinjstva iz Vukovara. Na kraju članka navedeno je da je u Zagrebu tada još živio sveučilišni profesor zoologije dr. Krunoslav Babić, koji je predavao kemiju u gimnaziji u Osijeku, kada ju je pohađao i Ružička, te je u svom profesorskom notesu, od kojih 35 godina prije 1940., pronašao i Ružičkine ocjene i konstatirao je da mu je *dijelio samo izvrsne ocjene iz kemije i tako dao temeljnu naobrazbu budućem Nobelovom laureatu.*

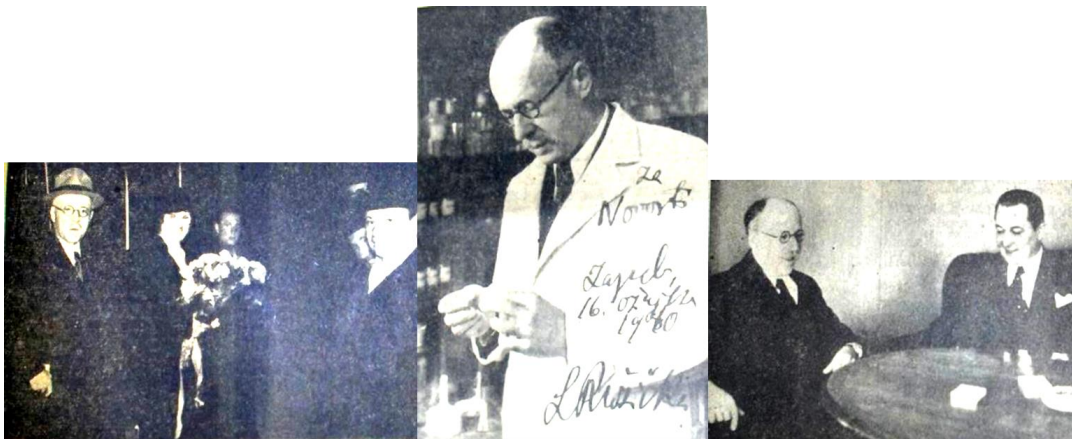

Prof. Ružička na zagrebačkom kolodvoru. Prof. Ružička u laboratoriju Ružička i ban dr. Ivo Šubašić

Slika 2. Fotografije dr. Ružičke objavljene u *Novostima*.

U članku: V – „Kulturna manifestacija visokog stila - Predavanje profesora Ružičke: "Drago mi je što ovdje mogu da održim predavanje na svom materinjem jeziku"“, *Novosti*, god. XXXIV., br. 76, 17. III. 1940., str. 4., dan je sažeti opis sadržaja Ružičkinog predavanja. Članak je zaključen sljedećim tekstom: „Poslije predavanja dra Ružičke, koje je bilo saslušano sa najvećom pažnjom i pozdravljeno pljeskom, pristupilo se predavanju diploma. U ime Hrvatskog kemijskog društva predao je dru Ružički predsjednik dr. ing. Pšenica uz topli govor, prekrasnu diplomu počasnog člana. Diplomom je izradila umjetnica Zdenka Sertić, a ukrasila ju je narodnim motivima vukovarskog, dakle rodnog kraja dra Ružičke. U ime Hrvatskog liječničkog zbora predao je dru

Uvodno izlaganje / Open lecture

Ružički diplomu počasnog člana predsjednik prof. dr. Vladimir Čepulić uz srdačan kratki govor. Diplomu je na pergameni izradila umjetnica Anka Martinić i uvezala je u kožu. Diploma je ukrašena hrvatskom narodnom ornamentikom (pleterom) i hrvatskim grbom te je vrlo lijepo izradjena. U ime Hrvatskog ljekarničkog društva, predao je dru Ružički diplomu počasnog člana g. Vojko Arko. Diplomu je umjetnički izradila gdja Olga Höker, ukrašivši je narodnim ornamentima i alkemijskim znakovima kao i znakom ljekarnika, a providjena je i hrvatskom trobojkom. Vrlo lijepe diplome počasnog člana predana su dru Ručiki i u ime Društva inženjera, te u ime zagrebačkog društva Srijemaca. Zatim je dr. Ružička dobio lijepu spomenicu u formi albuma od osamnaest vukovarskih društava. Ukrasio ju je umjetnik g. Ljudevit Fadljević. U kožnatom su albumu potpisi i žigovi svih vukovarskih društava, a zatim slike rodne kuće dra Ružičke u Novom Vukovaru i slike važnijih ulica i zgrada vukovarskih. Povjerenik grada Vukovara dr. Ante Topalović predao je dru Ružički diplomu počasnog građanina grada Vukovara. Umjetnički je tu diplomu izradio g. Fadljević. Nakon dugog vremena, u ovoj se ispravi po prvi puta ponovno daje i grb grada Vukovara. Dr. Ružička, očito ganut, zahvalio se na velikim počastima, kojima je bio obasipan, a ugledni auditorij pozdravljao je čitanje diploma i govore oduševljenim pljeskom i poklicima. Ovu krasnu svečanost završio je govorom dr. Bazala.“

Člankom „Doctor honoris causa dr. Lavoslav Ružička istakao je prilikom svečane promocije vjeru da će naša znanost dati još više lijepih plodova sada, kad su se sve snage hrvatskog naroda ujedinile“, *Novosti*, god. XXXIV., br. 77, 18. III. 1940., str. 5. – 6., obuhvaćene su i fotografije sa znamenitog Ružičkinog predavanja, održanog 16. ožujka 1940. (jedna je prikazana na Slici 3).



Slika 3. Ružičkino predavanje „Od dalmatinskog buhača do seksualnih hormona“, u Zagrebu, 16. ožujka 1940.

U članku: ENES (Niko Smolčić) – „Na večeri gradskog povjerenika profesor dr. Ružička je iskazao svu svoju radost i zahvalnost zemljacima“, *Novosti*, god. XXXIV., br. 77, 18. III. 1940., str. 6. – 7., po završetku pozdravnih govora, piše novinar, da je ustao sveučilišni prof. dr. Čepulić, koji je među ostalim rekao „da je zasluga pretsjednika Hrvatskog kemijskog društva dra ing. Nikole Pšenice što je sva naša znanstvena i stručna društva povezao s našim velikim zemljakom, provevši na uzoran način organizaciju svih priredbi.“

Dodao je dr. Čepulić da je dr. ing. N. Pšenica kroz tri mjeseca neumorno radio, pa mu je zahvalio u ime čitavog Odbora jer je organizacija tako lijepo uspjela. U članku: V. – „Profesor Dr. Ružička razgledava zagrebačke kulturne ustanove – Tekst diplome grada Vukovara i počast društva inženjera“, *Novosti*, god. XXXIV., br. 78, 19. III. 1940., str. 9., novinar je prenio Ružičkino žaljenje što neće moći posjetiti Vukovar, svoje rodno mjesto, koje ga je izabralo počasnim građaninom i uručilo mu diplomu, o čijoj se izvedbi vrlo pohvalno izrazio.

Članak pod naslovom „Laskava izjava prof. Ružičke o hrvatskoj nauci – Nobelov laureat oprostio se od Zagreba i njegovih političkih i kulturnih predstavnika“, donosi izvještaj s konferencije za medije, koju je Ružička sazvao 19. siječnja 1940., navečer, da se zahvali svima koji su doprinijeli njegovom uspješnom posjetu i boravku u Zagrebu. Između ostaloga Ružička je tada rekao: „Prije svoga odlaska želim da se zahvalim Odboru, koji me je ljubazno pozvao u Zagreb i koji mi je boravak ovdje učinio toliko ugodnim. Gosp. predsjednik Hrvatskog kemijskog društva dr. Pšenica, koji mi i kao kemičar i kao Vukovarac stoji osobito blizu, toliko je svoga skupocjenoga vremena žrtvovao, da mu se ne mogu dosta zahvaliti. Vukovarci i Srijemci, i oni od kuće i oni iz Zagreba iznenadili su me tolikim srdačnim iznenađenjima, da ne moram žaliti, što sam rođen u Vukovaru. ...“ Autor članka je naglasio da je, predsjednik HKD-a dr. ing. N. Pšenica, koji je bio nazočan na razgovoru Ružičke s novinarima, spomenuo na koncu izjave dra Ružičke, da je doček kao i boravak dra Ružičke u Zagrebu bio najveća kulturna manifestacija, koju je Hrvatska dotad doživjela, te da su za to, među ostalim uvelike zaslužni i zagrebački novinari. Navedenom razgovoru Ružičke s novinarima, pored dr. ing. N. Pšenice, bili su nazočni i još neki ugledni Vukovarci, kao dr. Nikola Andrić i dr. Tićak, vlasnik kuće u Vukovaru u kojoj se dr. Ružička rodio, te je izvjestio Ružičku, da je sve na toj kući ostalo netaknuto, kako je i prije bilo i da Vukovarci jednom željno očekuju Ružičkin posjet Vukovaru i rodnoj kući.

Zagrebački *Jutarnji list* objavio je ukupno 9 članaka vezanih za Ružičkino dobivanje Nobelove nagrade, te njegov dolazak u Zagreb, održavanje predavanja i proslavu dobitka te nagrade.²² U članku „Telefonski intervju s dobitnikom Nobelove nagrade Hrvatom Drom Lavoslavom Ružičkom: G. Dr. Ružička održat će u Zagrebu predavanje, koje je morao održati na

²² ** „Hrvat Dr. Ružička dobio Nobelovu nagradu: Dr. Lavoslav Ružička je rodom iz Vukovara, a profesor je na tehničkoj u Zürichu – Još su dva Nijemca dobila nagradu. – Znanstveni rad našeg zemljaka dra Lavoslava Ružičke“, *Jutarnji List*, 11. XI. 1939., str. 11.; ** „Telefonski intervju s dobitnikom Nobelove nagrade Hrvatom Drom Lavoslavom Ružičkom: G. Dr. Ružička održat će u Zagrebu predavanje, koje je morao održati na svečanostima u Stockholmu. – Posljednje pripreme posebnog odbora za doček i boravak Dra Ružičke“, *Jutarnji List*, 10. II. 1940., str. 11.; ** „Osnovana je nova sveučilišna zaklada za najbolje hrvatske studente - Povodom svečane promocije g. Dra Ružičke darovala je gđja Najpar 100.000 dinara kao zakladu Šandora i Marije Najpar“, *Jutarnji list*, 14. III. 1940., str. 17.; ** „Prvi Hrvat dobitnik Nobelove nagrade Dr. Lavoslav Ružička dolazi danas u petak u Zagreb – Izvanredan interes za predavanje. – Program boravka“, *Jutarnji list*, 15. II. 1940., 10.; ** „Pred dvije hiljade ljudi održao je danas predavanje prvi Hrvat koji je dobio Nobelovu nagradu – Predavanje je Dra Lavoslava Ružičke u dvorani Radničke komore bilo saslušano s velikim zanimanjem i popraćeno srdačnim odobravanjem. – Dr. Lavoslav Ružička je govorio lijepim hrvatskim jezikom. – Tko je sve prisustvovao predavanju. – Program boravka dra Ružičke u Zagrebu“, *Jutarnji list*, 17. III. 1940., str. 9.; ** „Prof. Dr. Ružička na svečan je način promoviran za počasnog doktora zagrebačkog medicinskog fakulteta – Svečanoj promociji prisustvovali su ban g. Dr. Šubašić i hrvatski metropolita preuzv. Dr. Stepinac. – Značajni govori rektora g. dra Živkovića, dekana medicinskog fakulteta g. dra Botteri-a i g. dra Ružičke. – Današnje priredbe u počast g. dra Ružičke“, *Jutarnji list* 18. III. 1940., str. 6.; ** „Dr. L. Ružička u Strossmayerovoj galeriji i Arheološkom muzeju – Dr. L. Ružička s velikim je interesom razgledavao hrvatske znanstvene ustanove“, *Jutarnji list* 19. III. 1940., str. 11.; ** „Dr. Lavoslav Ružička je ushićen dočekom i boravkom u Zagrebu“, *Jutarnji list* 20. III. 1940., str. 9.; ** „Jutros je Dr. L. Ružička oputovao iz Zagreba – Dr. Lavoslav Ružička: »Iz dana u dan sve mi je teže naći zgodan odgovor na pitanje, da li se osjećam Hrvatom ili Švicarcem« - Oproštajni razgovor Dra Lavoslava Ružičke sa suradnikom »Jutarnjeg lista«, *Jutarnji list* 21. III. 1940., str. 12.

Uvodno izlaganje / Open lecture

svečanostima u Stockholmu. – Posljednje pripreme posebnog odbora za doček i boravak Dra Ružičke“, *Jutarnji List*, 10. II. 1940., str. 11., navedeno je da su niz podataka dobili uglavnom od dr. ing. N. Pšenice, kojeg su kao predsjednika HKD-a posjetili i za kojeg su konstatalirali da kao Vukovarc vrši sve pripreme zajedno s posebnim odborom za doček i boravak dr. Ružičke u Zagrebu. Člankom „Jutros je Dr. L. Ružička otputovao iz Zagreba – Dr. Lavoslav Ružička: »Iz dana u dan sve mi je teže naći zgodan odgovor na pitanje, da li se osjećam Hrvatom ili Švicarcem« - Oproštajni razgovor Dra Lavoslava Ružičke sa suradnikom »Jutarnjeg lista«, *Jutarnji list* 21. III. 1940., str. 12., navedeno je da je Ružička zahvalio svima, a posebno dr. ing. N. Pšenici. Opisao je novinar i zahvalu dr. ing. N. Pšenice svim zagrebačkim novinarima, što su pridonijeli da je ta kulturno-nacionalna proslava, "najveća otkako Zagreb postoji", u potpunosti uspjela, te da su Vukovarci zajedno s Ružičkom otišli s njim na intimnu oproštajnu večeru.

Na već spomenutu temu vukovarski *Srijemski Hrvat*, objavio je ukupno 8 članaka.²³ U članku „Hrvatski Vukovar Zagrebu i Hrvatskoj – Povodom današnjih i sutrašnjih svečanosti i predavanja prvog Hrvata dobitnika Nobelove nagrade Vukovarca g. dra Ružičke u Zagrebu“, *Srijemski Hrvat*, God. II., 16. III. 1940., br. 12., str. 1., s ponosom je autor članka istaknuo, da svečanosti u Zagrebu vezane za nobelovca Ružičku organizira HKD, *kojemu opet stoji na čelu kao predsjednik naš Vukovarc g. dr. Pšenica*. Popisao je sve ugledne Vukovarce, koji su otputovali iz Vukovara u Zagreb i, među ostalim ponijeli Ružički povelju počasnog građanina grada Vukovara, i spomenicu s krasnim albumom fotografija iz Vukovara koju će predati „Zajednice vukovarskih hrvatskih kulturnih i narodnih društava“, a koju je umjetnički izradio Lujo Fadljević. Člankom koji nosi naslov „Vukovarski dani u Zagrebu (uz proslavu Dra Lavoslava Ružičke)“, dr. N. Andrić je naglasio da *u novijoj povijesti hrvatskoga naroda nije se još nikada ime i značenje jednog pokrajinskog grada tako iznenada i tako moćno usjeklo širom domovine u dušu svih pravih rodoljuba, kao ime Vukovara prigodom Ružičkine proslave u Zagrebu*. Istakao je dr. Andrić, da je dobrotvorka Vukovarka Marija ud. Najpar, doživjela nesvakidašnju počast, jer je rektor Hrvatskog sveučilišta u svom nadahnutom govoru u prigodi svečanosti Ružičkine promocije u počasnog doktora ovog sveučilišta, ukazao na veliko značenje dara od 100.000 dinara, koje je gospođa Najpar poklonila Hrvatskom sveučilištu u obrazovne svrhe i time „*vidno, trajno i realno*“ povezala spomen na najviše odlikovanje Vukovarca Ružičke i njegovu doktorsku vezu s Hrvatskim sveučilištem. Nakon takvih rektorovih riječi *sva odlična publika – s banom i nadbiskupom na čelu – udarila je u zaglušan aplauz, za koji je prisutna dobrotvorka morala ustajanjem i naklonom zahvaliti*.

Tri članka objavljena u vukovarskom *Srijemskom Hrvat*u, pod nadnaslovom „Proslava prof. Lavoslava Ružičke u Vukovaru“, pokazuju da se „Zajednica vukovarskih hrvatskih kulturnih i narodnih društava“, iznimno angažirala, da dobije od hrvatskih uglednika i Ružičkinih kolega iz doba gimnazijskog školovanja, kao što su rektor Hrvatskog sveučilišta, dr. Andrija Živković i

²³ ** „Hrvatski Vukovar Zagrebu i Hrvatskoj – Povodom današnjih i sutrašnjih svečanosti i predavanja prvog Hrvata dobitnika Nobelove nagrade Vukovarca g. dra Ružičke u Zagrebu“, *Srijemski Hrvat*, God. II., 16. III. 1940., br. 12., str. 1.; ** Nikola ANDRIĆ – Vukovarski dani u Zagrebu (uz proslavu Dra Lavoslava Ružičke), *Srijemski Hrvat*, God. II., 23. III. 1940., br. 13., str. 3.; ** „Proslava prof. Lavoslava Ružičke u Vukovaru“, *Srijemski Hrvat*, God. II., 8. V. 1940., br. 21., str. 2.; ** Antun MILFAJT – Proslava prof. Lavoslava Ružičke u Vukovaru - Iz prvih dana kemijske karijere Lav. Ružičke, *Srijemski Hrvat*, br. 21., 8. V. 1940., str. 2.; ** Andrija ŽIVKOVIĆ – „Proslava prof. Lavoslava Ružičke u Vukovaru - Dr. Ružička – počasni doktor hrvatskog sveučilišta“, *Srijemski Hrvat*, br. 21., 8. V. 1940., str. 2.; ** „Proslava prof. Lavoslava Ružičke u Vukovaru - Ružičkin oproštaj s Hrvatskom“, *Srijemski Hrvat*, br. 21., 8. V. 1940., str. 2.; ** „Proslava dra Ružičke“, *Srijemski Hrvat*, br. 22., 25. V. 1940., str. 3.; ** „Razgovor s vukovarskim dobitnikom Nobelove nagrade prof. Ružičkom“, *Srijemski Hrvat*, br. 22., 25. V. 1940., str. 3.

svećenik-župnik Antun Milfajt, što više podataka iz Ružičkinog života, te da to objavi kao pripremu za organiziranje svečane akademije, na kojoj će se iznijeti djelovanje i rad prof. Ladislava²⁴ Ružičke, rođenog Vukovarca, koji je odlikovan najvišim odlikovanjem za zasluge u radu na naučnom polju 19. svibnja 1940. u Vukovaru. Autor je objavio i Ružičkinu fotografiju iz laboratorija, na kojoj se Ružička potpisao, kao Vukovarac s posvetom Srijemskom Hrvatu (Slika 4).



Slika 4. Ružičkina fotografija s posvetom Srijemskom Hrvatu

Članak pod naslovom „Proslava dra Ružičke“, informacija je o priredbi održanoj 19. svibnja 1940. u velikoj dvorani „Hrvatskog doma“ u Vukovaru, posvećenoj u čast prvog hrvatskog nobelovca, Vukovarca prof. dr. L. Ružičke. Navedeno je da je uvodno nazočne pozdravio predsjednik „Hrvatske čitaonice“ Mijo Kuhner, koji je kazao, da je hrvatski narod često dao velike priloge općoj svjetskoj kulturi, ali se o tome malo zna. Dodao je, da hrvatski narod, kroz svoje velikane duha dokazuje, da on nije neplodna grana na općem kulturnom stablu i da je sposoban makar i malobrojan, da velika djela stvori i nađe se uz bok najbrojnih i najkulturnijih naroda. Autor članka dalje navodi, da je iza Kuhnera govorio profesor Đuro Subotić. Njegovo izlaganje odnosilo se na značaj Ružičkinog rada i uspjeha na polju kemije, te je na popularan način i s velikim uspjehom, protumačio ono što je inače dosta teško razumjeti nestručnjaku. Treći govornik bio je dr. Emil Švagel, koji je po autoru teksta govorio o ulozi hormona u čovječjem tijelu. Na kraju, su svi predavači pobrali dugotrajan aplauz od posjetitelja koji su bili na visokoj intelektualnoj razini, a aplauzom je pozdravljeno i lijepo pismo, koje je pročitao Kuhner, a poslano je, s te priredbe, dr. Ružički. Ova priredba mogla bi se označiti prapočetkom današnjeg međunarodnog znanstveno-stručnog skupa „Ružičkini dani“!

²⁴ Ime Ladislav nije Ružičkino ime, pa je ovo najvjerojatnije tiskarska pogreška!

U vrijeme Ružičkine proslave u Zagrebu u Osijeku je izlazio *Hrvatski list*, koji je o toj tematici objavio ukupno 8 članaka.²⁵ Raduje se čitatelj *Hrvatskog lista*, R. H., u članku „Pisma iz građanstva: Povodom dolaska prof. Lavoslava Ružičke u domovinu“, *Hrvatski list*, God. XXI., br. 46 (6744), 16. II. 1940., str. 14. – 15., da je došlo vrijeme da se i kod nas zaslužni ljudi cijene i poštuju još za njihova života. Stoga konstatira da će se svi Hrvati veseliti, kada se u Zagrebu bude slavio dr. Ružička, te da će se veseliti Vukovar, *kada ga bude posjetio njegov sin, kojemu se slava širi u svim naučnim krugovima svijeta*. Dodaje da bi se trebao veseliti i Osijek, *ako i njega zapadne sreća, da među svojim zidovima pozdravi ovog velikana duha, koji je osim univerzitetskih nauka sve druge nauke – dakle pučku školu i svih osam razreda bivše naše klasične gimnazije – svršio u Osijeku*. Čitatelj u svom pismu izražava nadu da će Ružička doći i u Vukovar, ali i u Osijek, za koji kaže da bi trebao pripremiti *doličan doček ovom prodičenom osječkom đaku*. Predložio je, a vjeruje da je to u ime čitavog građanstva, napose u ime intelektualaca, *da gradska općina, kao nadzorna školska vlast službeno pozove profesora Ružičku u Osijek*. Još je čitatelj predložio, da bi banski povjerenik, kao vrhovni reprezentant gradske općine, mogao sastaviti jedan odbor, u koji bi trebali da uđu ravnatelji svih osječkih srednjih škola, ona gospoda profesori koji su Ružički bili nastavnici, predsjednici društava „Zajednica doma i škole“ i po jedan predstavnik glavnih osječkih kulturno-prosvjetnih ustanova. Isto tako je predložio čitatelj, da bi se moglo Ružičku zamoliti da po svom nahođenju održi jedno kratko predavanje, a vjeruje da bi se našlo vremena da se Ružička nađe na jednom domjenku sa svojim profesorima i školskim kolegama. Svoje pismo zaključio je čitatelj, riječima: „Smatram, da bi s naše strane bio neoprostiv i nepopravljiv propust, ako bi se propustila ova prilika, da se odade zaslužena počast ovakovom zaslužnom našem sinu.“ Prema sadržaju pisma, potpisani inicijalima R. H., vjerojatno je pripadnik osječkih intelektualaca, koji je bio nezadovoljan inertnošću osječkih gradskih vlasti, vezano za činjenicu da je dr. Ružička dobio Nobelovu nagradu i da je najavio svoj dolazak u domovinu. Htio je svojim pismom potaknuti gradske vlasti da preuzmu inicijativu i pozovu Ružičku u Osijek, ali po svoj prilici nije u tome uspio. Naime, Ružička tada nije došao ni u Vukovar, ali su vukovarske vlasti i sve ustanove i udruge poduzele sve da odaju najviša priznanja Ružički u Zagrebu, kad već nije došao u Vukovar, dok od Osječana, po svoj prilici, nije bilo nikoga na svečanostima koje su se dogodile od 15. do 20. ožujka 1940.!

Hrvatski dnevnik, objavio je 5 značajnih, nepotpisanih članaka o boravku nobelovca Ružičke u Zagrebu od 15. do 20. ožujka 1940.²⁶

²⁵ ** „Hrvat dobio Nobelovu nagradu: Dr. Lavoslav Ružička, rodом iz Vukovara, a osječki đak, dobio Nobelovu nagradu za kemiju“, *Hrvatski list*, God. XX., br. 335 (6650), 11. XI. 1939., str. 2.; ** „Ove godine ne će biti Nobelove svečanosti“, *Hrvatski list*, God. XX., br. 339 (6654), 15. XI. 1939., str. 10.; ** „Dobitnik Nobelove nagrade profesor Lavoslav Ružička priča o svojim mladenačkim uspomenaма, Osijeku i osječkim profesorima“, *Hrvatski list*, God. XX., br. 357 (6672), 3. XII. 1939., str. 11.; R. H. – Pisma iz građanstva: Povodom dolaska prof. Lavoslava Ružičke u domovinu, *Hrvatski list*, God. XXI., br. 46 (6744), 16. II. 1940., str. 14. – 15.; ** Novosti iz Vukovara: Priprema za doček dra Ružičke u Vukovaru, *Hrvatski list*, God. XXI., br. 54 (6752), 24. II. 1940., str. 6.; ** Novosti iz Vukovara: Sastanak "Zajednice hrvatskih društava", *Hrvatski list*, God. XXI., br. 55 (6753), 25. II. 1940., str. 22.; ** Novosti iz Vukovara: Izaslanici iz Vukovara na dočeku dra Ružičke u Zagrebu, *Hrvatski list*, God. XXI., br. 75 (6773), 16. III. 1940., str. 6.: Antun MILFAJT – Uspomene na prof. Ružičku: Povodom njegova odlikovanja Nobelovom nagradom i promoviranja na čast doktora hrvatskog sveučilišta, *Hrvatski list*, God. XXI., br. 76 (6774), 17. III. 1940., str. 7.

²⁶ ** „U Zagreb danas dolazi prvi Hrvat, koji je dobio Nobelovu nagradu: Svečanostima prigodom boravka dra Ružičke prisustvuje 1.600 osoba raznih znanstvenih i stručnih ustanova i društava – predavanje će se prenositi preko zagrebačke radiostanice za Ljubljanu i Beograd“, *Hrvatski dnevnik*, 16. ožujka 1940., str. 8.; ** „Poznata dobrotvorka iz Vukovara u Zagrebu“, *Hrvatski dnevnik*, 17. III. 1940.; ** „Predavanje prof. dra Ružičke: glavni grad Hrvatske srdačno

Autor članka „Predavanje prof. dra Ružičke: glavni grad Hrvatske srdačno primio glasovitog učenjaka Hrvata“, *Hrvatski dnevnik*, 17. ožujka 1940., str. 4., navodi da se po svršetku predavanja dra Ružičke dvoranom prolomio buran pljesak, a nakon toga su Ružički, u znak visokog poštovanja, predane diplome, koje su pripremila razna društva. Prvo je gradski povjerenik rodnog Ružičkinog grada Vukovara, dr. Topalović, predao diplomu s grbom grada Vukovara, koju je izradio Ljudevit Fadljević. Pri tome je dr. Topalović rekao: „Vašem odlikovanju "Nobelovom nagradom", od svih hrvatskih gradova, što je i razumljivo, najviše se veseli i raduje Vaš rodni grad Vukovar. Tim najvišim svjetskim odlikovanjem, koje ste Vi, do sada jedini Hrvat, postigli za Vaš znanstveni rad na polju kemije, počašćen je i proslavljen napose i Vaš rodni grad Vukovar. Stoga općina grada Vukovara odazivljući se jednodušnoj želji svoga hrvatskog građanstva, da Vam se bar donekle oduži i oda Vam zaslužena priznanja imenovala Vas je svojim počasnim građaninom. Ja kao banski povjerenik za općinu grada Vukovara, neobično sam sretan i smatram se neizmjereno počašćenim tom nada sve ugodnom dužnošću, da Vas na ovoj svečanoj akademiji, u ime grada Vukovara pozdravim i najsrdačnije Vam čestitam, kako na odlikovanjima, kojima Vas danas počastiše stručne ustanove i društva hrvatske metropole našeg bijelog Zagreba, tako i na odlikovanju, kojim Vas je počastio Vaš rodni grad Vukovar. Predajući Vam ovu diplomu počasnog građanina, želim, da Vas ona i u tuđem svijetu uvijek živo podsjeća na Vaš rodni i nekad zavičajni grad Vukovar i da ga, kad Vam ovom prilikom to nažalost nije moguće uskoro počastite Vašim posjetom.“

Članak pod naslovom „Hrvatski učenjak, dobitnik Nobelove nagrade dr L. Ružička otputovao iz Zagreba i ponio u Švicarsku nezaboravne dojmove iz svoje domovine Hrvatske“, navodi da je Ružička izabrao Zagreb kao metropolu svoje domovine Hrvatske da održi u njemu predavanje, koje je dužan održati kao dobitnik Nobelove nagrade, što je bila velika čast za hrvatski narod, a Ružička je tim činom dokazao veliku ljubav prema domovini Hrvatskoj. Nadalje, autor članka navodi da je 19. ožujka 1940., navečer Ružička u hotelu „Esplanadi“ primio novinare i između ostaloga, rekao: „»Prije odlaska želim da se zahvalim Odboru, koji me je ljubazno pozvao u Zagreb i koji mi je boravak ovdje učinio veoma ugodnim. **Prof. dr. Pšenica, koji mi i kao kemičar i kao Vukovarčanin stoji osobito blizu, toliko je svog skupocjenog vremena žrtvovao, da mu se ne mogu dovoljno zahvaliti.** Vukovarčani i Srijemci, oni od kuće i iz Zagreba iznenadili su me tako srdačno, da ne moram žaliti, što sam rođen u Vukovaru. Hrvatsko sveučilište na čelu s rektorom drom Andrijom Živkovićem, mojim drugom, pružilo mi je priliku, da sam mogao doživjeti najsvečaniji akt svoje sveučilišne karijere. ... **Prof. dr. Pšenica, koji je bio prisutan razgovoru s novinarima spomenuo je na koncu izjave dra Ružičke, da je doček kao i boravak dra Ružičke u Zagrebu bio najveća kulturna manifestacija, koju je Hrvatska doživjela.**“

Beogradska *Politika* objavila je 6 članka o dodjeli Nobelove nagrade dr. Ružički i njegovom boravku u Zagrebu od 15. do 20. ožujka 1940., čime je pokazala veliko zanimanje za ovaj događaj.²⁷

primio glasovitog učenjaka Hrvata“, *Hrvatski dnevnik*, 17. ožujka 1940., str. 4.; ** „Svečana promocija Hrvata-laureata Nobelove nagrade dra Ružičke na čast doktora medicine na Hrvatskom sveučilištu u Zagrebu – govori rektora dra A. Živkovića i laureata dra Ružičke“, *Hrvatski dnevnik*, 18. ožujka 1940., str. 2.; ** „Hrvatski učenjak, dobitnik Nobelove nagrade dr L. Ružička otputovao iz Zagreba i ponio u Švicarsku nezaboravne dojmove iz svoje domovine Hrvatske“, *Hrvatski dnevnik*, 21. ožujka 1940., str. 8.

²⁷ Dr. L. S. – „Iz medicine: Hemiski sastav i dejstvo polnih hormona tačno su ispitani (Zbog čega su naš zemljak profesor Ružička i nemački profesor Butenand dobili ovogodišnju Nobelovu nagradu za hemiju)“, *Politika*, God. XXXVI. (31. XII.

Uvodno izlaganje / Open lecture

Interesantno je primijetiti da dopisnik *Politike* iz Zagreba, Vasa Jakšić, Ružičku naziva *naš zemljak*, ne spominjući da je Hrvat, te da Ružička, unatoč trideset i četverogodišnjem izbjavanju, još uvijek dobro govori *naš jezik*, dakle neće da kaže da je to hrvatski jezik. U članku „Ovogodišnji nosilac Nobelove nagrade za hemiju, naš zemljak g. dr. Lavoslav Ružička, o svom životu i radu – Kako je g. dr. Ružička dobio Nobelovu nagradu“, autor pojašnjava znanstveni opus dr. Ružičke i uz tekst je priložio i fotografiju dr. Ružičke s njegovom gospođom (Slika 5).



Slika 5. Dr. Ružička s gospođom Annom

Zagrebački *Obzor*, objavio je 5 članka o dodjeli Nobelove nagrade dr. Ružički i njegovom boravku u Zagrebu od 15. do 20. ožujka 1940.²⁸ Zagrebačke novine *Večer*, objavile su tri članka o dodjeli Nobelove nagrade dr. Ružički i njegovom boravku u Zagrebu od 15. do 20. ožujka 1940.²⁹ Đakovački list *Hrvatska obrana* objavio je 3 članka o dodjeli Nobelove nagrade dr. Ružički i njegovom boravku u Zagrebu od 15. do 20. ožujka 1940.³⁰

1939.), br. 11346, str. 20.; ** „Nosilac ovogodišnje Nobelove nagrade naš zemljak g. dr. L. Ružička u Zagrebu“, *Politika*, God. XXXVII. (15. III. 1940.), br. 11418, str. 10.; ** „Ovogodišnji nosilac Nobelove nagrade za hemiju naš zemljak g. dr. L. Ružička doputovao je u Zagreb – Jučer posle podne on je održao predavanje o temi: "Od dalmatinskog buhača do seksualnih hormona", *Politika*, God. XXXVII. (17. III. 1940.), br. 11420, str. 19.; ** „Zagrebački univerzitet promovisao je jučer za počasnog doktora medicine nosioca Nobelove nagrade g. dr. Ružičku“, *Politika*, God. XXXVII. (18. III. 1940.), br. 11421, str. 8.; ** „G. dr. L. Ružička otputovao iz Zagreba“, *Politika*, God. XXXVII. (21. III. 1940.), br. 11424, str. 9.; Vasa JAKŠIĆ – Ovogodišnji nosilac Nobelove nagrade za hemiju, naš zemljak g. dr. Lavoslav Ružička, o svom životu i radu – Kako je g. dr. Ružička dobio Nobelovu nagradu, *Politika*, God. XXXVII. (24. III. 1940.), br. 11427, str. 28. ** „Dobitnici Nobelove nagrade“, *Obzor*, 10. XI. 1939., str. 1.; ** „Dolazak Dra Lavoslava Ružičke u Zagreb“, *Obzor*, 14. III. 1940., str. 4.; ** „Prof. Dr. Ružička u Zagrebu“, *Obzor*, 16. III. 1940., str. 4.; ** „Promocija Prof. Dra Lavoslava Ružičke“, *Obzor*, 18. III. 1940., str. 4.; ** „Društvo inženjera u počast dru Ružičke“, *Obzor*, 18. III. 1940., str. 4.

²⁹ ** Dobitnik Nobelove nagrade dr. Ružička posjetio je bana hrvatske i dra Vladka Mačeka - Za današnje predavanje dobitnika Nobelove nagrade vlada ogroman interes - sutra će dr. Ružička biti promoviran na čast doktora medicine honoris causa, *Večer*, God. XXI., 16. ožujka 1940., str. 2.; ** „Večera starih drugova dr. Ružičke i njegovih profesora - jedno ugodno veče u »Esplanadu« u kojem su se našli na okupu svi školski drugovi g. dr. Ružičke i profesori - g. dr. Ružička vraća se sutra u Zürich“, *Večer*, God. XXI., 18. ožujka 1940., str. 2.; ** „Jutros je dr. Ružička otputovao iz Zagreba - »Hormoni koriste starim ljudima i nedovoljno razvijenoj mladeži«, rekao je prof. dr. Ružička - Boravak dra Ružičke u zagrebu učinio je, da bi mu teško bilo odgovoriti da li se osjeća Hrvatom ili Švicarom. - g. dr. Maček sastao se s g. drom Ružičkom na kolodvoru i zaželio mu sve dobro“, *Večer*, God. XXI., 20. ožujka 1940., str. 3.

³⁰ ** „Sitne vijesti iz inozemstva: Hrvatski učenjak dr. Lavoslav Ružička primio je nekidan u Zürichu Nobelovu nagradu za kemiju“, *Hrvatska obrana*, God. XXI. (21. I. 1940.), br. 3., str. 1.; ** „Dar hrv. sveučilištu“, *Hrvatska obrana*, God. XXI. (17. III. 1940.), br. 10., str. 1.; ** „Promocija dra Ružičke u Zagrebu“, *Hrvatska obrana*, God. XXI. (24. III. 1940.), br. 11., str. 9.

Splitski *Narodni list* objavio je 2 članka o dodjeli Nobelove nagrade dr. Ružički i njegovom boravku u Zagrebu od 15. do 20 ožujka 1940.³¹ *Primorske novine*, izdavane na Sušaku, objavile su 2 članka o dodjeli Nobelove nagrade dr. Ružički i njegovom boravku u Zagrebu od 15. do 20 ožujka 1940.^{32,33} Zagrebačka *Nedjelja* objavila je jedan članak o dodjeli Nobelove nagrade dr. Ružički i njegovom boravku u Zagrebu od 15. do 20 ožujka 1940. Taj članak nosi naslov „Prvi Hrvat Nobelov laureat u Zagrebu“.³⁴ Autor teksta je napisao svoje misli, vezano za Ružičkin dobitak ove svjetski najprestižnije nagrade: „Prof. Ružička, učenjak svjetskoga glasa, je Hrvat, no da li svijet znade što je on zapravo i ne drži li ga svijet Švicarcem, što on doduše po državljanstvu jest, ali ne po narodnosti? Svoje predavanje držao je prof. Ružička na hrvatskom jeziku. I zar naši ljudi samo vani mogu dokazati da smo i mi Hrvati na visini drugih naroda?“ Uz konstataciju da je proslava dr. Ružičke u Zagrebu bila svečana, autor teksta dodaje da se zapazilo da on nije mason, *jer bi inače stvar ispala još daleko svečanije*. Napose se u članku pohvaljuje lijepa gesta Vukovarke Marije Najpar, koja je povodom te proslave, poklonila zagrebačkom sveučilištu 100.000 dinara, te se dodaje da bi se u njen primjer trebali ugledati i drugi imućniji Hrvati, jer je takvih dobrotvora jako malo. Pohvaljuje se i namjena te zaklade, koju je M. Najpar odredila za *redovite slušače hrvatskog sveučilišta, čestite Hrvate, za radnje koje bi promicale poznavanje hrvatskog jezika, hrvatske književnosti, povijesti i etnografije, i to uz uvijet, da se radnje ne kose s katoličkom vjerskim uvjerenjem hrvatskog naroda*.

Zagrebački list za mladež, *Smilje* objavilo je jedan članak o dodjeli Nobelove nagrade dr. Ružički i njegovom boravku u Zagrebu od 15. do 20 ožujka 1940. Rad nosi naslov „Hrvat dr. Ružička dobio Nobelovu nagradu“, i izvješćuje da je nedavno dr. Ružička, kao prvi Hrvat, dobio Nobelovu nagradu za kemiju. Dodaje se da je dr. Ružička rodom iz Vukovara i da *živi u tuđem svijetu, u Švicarskoj*.³⁵

PROBLEM CENZURIRANJA ČLANKA DR. ING. NIKOLE PŠENICE

Kako je već navedeno, dr. ing. Nikola Pšenica je napisao članak pod naslovom „Boravak prof. dra. Lavoslava Ružičke u Zagrebu od 15.-20. III. 1940.“,³⁶ koji mu je bio cenzuriran. Inače, na cenzuriranje navedenog članka N. Pšenice, ukazao je Gjuro Deželić u svom članku „Cenzurirani nobelovci - U kojim uvjetima se uređivao "Kemijski vjestnik (Arhiv za kemiju i tehnologiju)", preteča današnjih časopisa "Croatica Chemica Acta" i "Kemija u industriji", u vrijeme II. svjetskog rata“.³⁷ On je u arhivskoj ostavštini svoga oca dr. Mladena Deželića (1900. - 1989.) pronašao sačuvane dokumente, koji pokazuju da je znanstveni časopis "Kemijski vjestnik (Arhiv za kemiju i tehnologiju)", kojeg je glavni urednik bio dr. M. Deželić, a koji je od 1941. do

³¹ ** „Osječanin dr. Lavoslav Ružička dobio Nobelovu nagradu za kemiju“, *Narodni list* (Split), God. I., br. 3. 16. XI. 1939., str. 8.; ** „Pomanjkanje narodnog ponosa ...“, *Narodni list* (Split), God. I., br. 11., 21. III. 1940., str. 4.

³² „Hrvat dr. Lavoslav Ružička dobitnik Nobelove nagrade za kemiju“, *Primorske novine*, God. V. (11. XI. 1939.), br. 1325, str. 1.

³³ „Svečana promocija dr. Ružičke u Zagrebu“, *Primorske novine*, God. VI. (18. III. 1940.), br. 1430, str. 1.

³⁴ „Prvi Hrvat Nobelov laureat u Zagrebu“, *Nedjelja*, br. 12., (1940.), str. 7.

³⁵ „Hrvat dr. Ružička dobio Nobelovu nagradu“, *Smilje*, God. LXXIX. (I. 1940.), br. 5., str. 94.

³⁶ Nikola PŠENICA - Boravak prof. dra. Lavoslava Ružičke u Zagrebu od 15.-20. III. 1940., *Kemijski vjestnik (Arhiv za kemiju i tehnologiju)*, God. XV i XVI. (1941-42.), str. 92. – 126.

³⁷ Gjuro DEŽELIĆ - „Cenzurirani nobelovci - U kojim uvjetima se uređivao "Kemijski vjestnik (Arhiv za kemiju i tehnologiju)", preteča današnjih časopisa "Croatica Chemica Acta" i "Kemija u industriji", u vrijeme II. svjetskog rata“, *KUI*, 54 (5) (2005.), str. 280. – 282.

1943. izašao u dva sveska, godišta XV./XVI. (1941.-42.) i XVII. (1943.), potpao pod cenzorski nadzor. Navodi Gj. Deželić, da je dva dana nakon što je M. Deželić izabran za urednika, 22. rujna 1942., primio pismo Nikole Pšenice s priloženim rukopisom "Dr. Lavoslav Ružička, boravak velikog učenjaka u Zagrebu od 15. do 20. ožujka 1940.", a u popratnom pismu je rekao da je korekturu sloga spreman obaviti, ali da izjavljuje, da nikako ne pristaje na kakav god stilistički ili jezični ispravak u tekstu ili kakovo god smanjenje ili nadopunu. Konstatirao je Gj. Deželić: „Taj je članak bio tim više značajan, jer je dr. Pšenica, rođeni Vukovarac kao i Ružička, tada na dužnosti predsjednika HKD, bio osobito zaslužan za ostvarenje ove značajne općehrvatske manifestacije koja je pobudila golem interes javnosti i koja je mobilizirala sve najznačajnije hrvatske kulturne institucije da se pridruže organiziranju Ružičkina dolaska u Zagreb.“ No, kada su u uredništvu dobili dopis 25. veljače 1943., iz *Glavnog ravnateljstva za promičbu u Ministarstvu narodne prosvjete NDH, sa žigom Novinskog odsjeka Državnog izvještajnog i promičbenog ureda kod Predsjedništva vlade NDH*, potpisan od nadzornika Hasana Šuljaka, u kojem se traži da sam pisac udesi svoj prikaz tako, da bi izostala imena ljudi, koji su uklonjeni iz javnog hrvatskog života i sva ona mjesta, gdje se iztiču pacifističke i ine misli, koje bi u sadašnjim ratnim prilikama na neke ljude mogle neugodno djelovati, a možda bi nam se zamjerilo i sa strane naših saveznika.

Još je Gj. Deželić u svom članku naveo: „Nije sačuvana nikakva druga bilješka o reakciji autora Pšenice, mogućim kontaktima s navedenim uredom prije tiska, ali se iz tiskanog članka vidi da je Pšenica ipak bio prisiljen odustati od prvotnog zahtjeva da ne pristaje na bilo kakve izmjene u članku. U Deželićevom arhivu nema originala članka, pa nije poznato kakve je sve izmjene autor unio.“ No, u knjižnici Katoličkog bogoslovnog fakulteta u Zagrebu, pronađen je primjerak rukopisne ostavštine navedenog članka dr. ing. N. Pšenice, u kojem je on ukazao na rečenu cenzuru, svojom „Uvodnom primjedbom“ od 7. svibnja 1945., zajedno s cenzorovim dopisom.³⁸ Tu je Pšenica naveo, da po cenzuri križani, ispravljani i izmijenjen rukopis i tiskani otisci, nalaze se u njegovom posjedu. Nažalost ti primjerci nisu pronađeni, ali temeljem ovoga očitovanja N. Pšenice, i kopije njegovog ukazivanja na cenzorske intervencije (Slika 6), kojih je pobrojano ukupno 36, pronađenih u knjižnici KBF-a u Zagrebu, može se rekonstruirati originalni tekst toga članka. Inače, u tom članku Dr. Ing. N. Pšenica detaljno je opisao pripreme, dolazak i boravak dr. Ružičke u Zagrebu od 15. do 20. ožujka 1940. Opisujući čuveno Ružičkino predavanje održano 16. ožujka 1940. pred oko 1600 slušatelja, kaže Pšenica, da su dr. Ružičku, nakon jednosatnog predavanja pozdravili svi prisutni oduševljenim pljeskom. Iza toga predsjednik HDK u Zagrebu dr. Ing. N. Pšenica, pozdravio je toplim govorom dr. Ružičku, te je istakao, da je dr. Ružička jedan od osnivača HKD-a u godini 1926., redovni član od tada do te 1940., te da ga je HKD izabrao za svog prvoga počasnog člana. Nakon toga je dr. ing. Pšenica predao Ružički prekrasnu diplomu, koju je izradila u koži hrvatska umjetnica prof. Zdenka Sertić, ukrasivši ju narodnim motivima vukovarskog t. j. rodnog kraja dra Ružičke.³⁹ Ono što treba izdvojiti iz članka N. Pšenice je i sljedeći tekst: „U utorak 19. III. 1940. Dr. Ružička održao je sastanak sa zagrebačkim novinarima i izvjestiteljima velikih dnevnika u salonima Hotela Esplanade, kod kojeg je prisustvovao Dr. Nikola Andrić i Dr. Nikola Pšenica, te je izjavio: "Prije svoga odlaska želim, da se zahvalim odboru stručnih društava i ustanova, koji me je ljubazno pozvao u Zagreb i koji

³⁸ Biblioteka Katoličkog bogoslovnog fakulteta u Zagrebu, br. 153 94 12, S-28812/1945.

³⁹ Nikola PŠENICA - Boravak prof. dra. Lavoslava Ružičke u Zagrebu od 15.-20. III. 1940., *Kemijski vjestnik (Arhiv za kemiju i tehnologiju)*, God. XV i XVI. (1941-42.), str. 110. – 111.

mi je boravak ovdje učinio toliko ugodnim. **G. predsjednik Hrvatskog kemijskog društva Dr. Pšenica, koji mi i kao kemičar i kao Vukovarac stoji osobito blizu, toliko je svoga skupocjenoga vremena žrtvovao, da mu ne mogu dosta zahvaliti.** Vukovarci i Srijemci, i oni od kuće i oni iz Zagreba, iznenadili su me tolikim srdačnim iznenađenjima, da ne moram žaliti, što sam rođen u Vukovaru." ... Predsjednik Hrvatskog kemijskog društva Dr. Ing. Nikola Pšenica naročito je naglasio, da velika hvala za uspjeh kulturne manifestacije grada Zagreba prilikom boravka Dra Ružičke u Zagrebu ide zagrebačkom novinstvu. Ono je mnogo pridonijelo tome, da se boravak Dra Ružičke u Zagrebu pretvorio u tako veliku kulturnu manifestaciju kakvu do danas nismo imali. Novinstvo se ovaj puta pokazalo doista - rekao je dr. Pšenica - na zamjernoj visini, na čemu mu velika hvala. ... Na uspomenu dobivanja Nobelove nagrade izradio je za Dra Ružičku švicarski medaljar W. F. Kunz u Zürichu umjetničku plaketu, od kojih je poklonio Dr. Ružička u Zagrebu 5 komada, i od toga jednu g. **Dru Pšenici, predsjedniku Hrvatskog kemijskog društva u Zagrebu, osobno.**⁴⁰

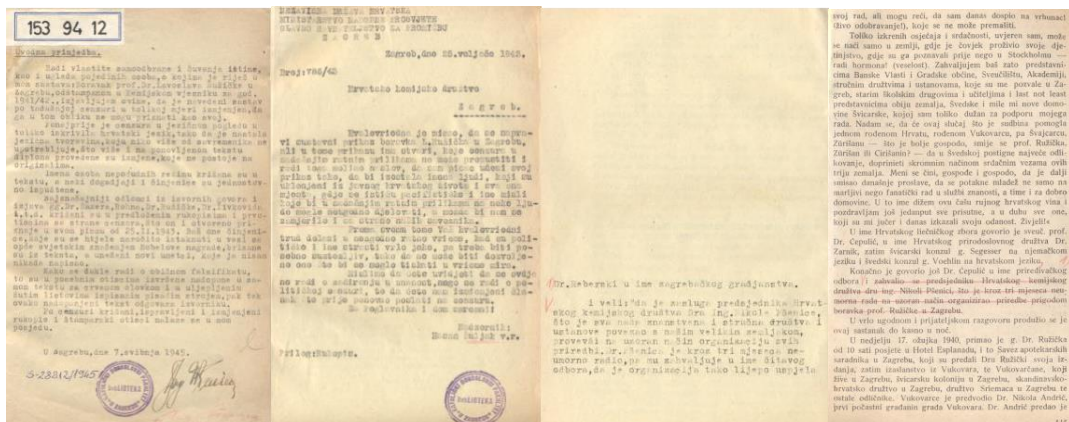

Slika 6. Očitovanje N. Pšenice o cenzuriranju njegovog članka i dopis od cenzora (KBF, Zagreb)

Na kraju svoga članka N. Pšenica je naveo da je 28. ožujka 1942. proglašen i proveden razlaz »Odbora znanstvenih i stručnih ustanova i društava za doček i boravak Dra Lavoslava Ružičke u Zagrebu«. Još je naveo da je Hrvatsko prirodoslovno društvo u Zagrebu izabralo dr. Ružičku, na svojoj redovitoj godišnjoj glavnoj skupštini održanoj u travnju 1940. u Zagrebu, za svog počasnog člana, a *Akademija znanosti i umjetnosti u Zagrebu izabrala je na svojoj skupnoj sjednici održanoj 7. VI. 1940. Prof. Dra Ružičku za svog počasnog člana.*

Isto tako izvijestio je Pšenica, da je Društvo Osječana u Zagrebu, uputilo dr. Ružički 3. svibnja 1940. pismo u kojem se, među ostalim kaže: „»Prigodom Vašeg slavom ovjenčanog boravka u prvoj Vašoj domovini Hrvatskoj, koja je sretna i ponosna, da je iako mala, dala svijetu uz Strossmayera i drugih velikana još jednog velikog naučenjaka. Društvo Osječana u Zagrebu nije

⁴⁰ Nikola PŠENICA - Boravak prof. dra. Lavoslava Ružičke u Zagrebu od 15.-20. III. 1940., *Kemijski vjestnik (Arhiv za kemiju i tehnologiju)*, God. XV i XVI. (1941-42.), str. 121. – 124.

htjelo ni smjelo,⁴¹ da oduzme ili da se bori za prvenstvo sa bratskim društvom Vukovarčana, pa je stoga zaključilo, da Vam ovim putem čestita i izrazi svoju zahvalnost. ... Društvo Osječana u Zagrebu drži, da ne griješi kada smatra, da Vi nemate samo dvije domovine, već da imadete tako rekuć i dva rodna mjesta. U Vukovaru započeo je Vaš tjelesni život, a u Osijeku Vaš duhovni. Temelje Vaše današnje svjetske veličine primili ste u školama našeg dragog Osijeka. U njemu ste proživili nezaboravne dane rane mladosti i đakovanja. Zato mislimo da i mi imademo pravo da Vas svojatamo za sebe i da se s Vama ponosimo, a i dužnost da Vam budemo zahvalni. Saopćujući taj zaključak, slobodni smo Vam poslati album grada Osijeka koji neka Vas i u velikom svijetu sjeća malog Vašeg Osijeka i Vašeg djetinjstva.

Za upravni odbor, Stjepan Jobst, v. r., predsjednik; Lujo Šestić, v. r., tajnik.«⁴²

I na samom kraju zaključuje dr. ing. N. Pšenica: „Zaključujući time ovaj prikaz o Dru Ružički i poredavši sve pojedinosti, koje se odnose na Vukovar i na Zagreb prema činjeničnom stanju, izvršio sam time jednu dužnost, sačuvavši na taj način mnoge pojedinosti od zaborava. Dajem time budućem biografu Dra Ružičke građu i putokaze na odnosna vrela, a to mi je još danas tim lakše, jer su **sve niti priprava o Nobelovom predavanju i o boravku Dra Ružičke u Zagrebu od 16. do 20. III. 1940. bile u mojim rukama.** Što se dalje odmičemo od tih dana, blijeđi sve jače sjećanje, a i redovi suvremenika postaju sve rjeđi. Zagreb, 30. ožujka 1942.“

ZAKLJUČAK

Prema svemu iznijetom proizlazi da je dr. ing. Nikola Pšenica, kao suvremenik našeg prvoga nobelovca Ružičke i njegov susjed Vukovarac po rođenju, imao iznimnu ulogu u organiziranju Ružičkine proslave dobitka Nobelove nagrade, koja je održana u Zagrebu od 15. do 20. ožujka 1940. On je, po općoj ocjeni, sva hrvatska znanstvena i stručna društva uspješno povezao s Ružičkom, te je proveo na uzoran način organizaciju svih priredbi i događaja, koji su bili tada posvećeni našem prvom nobelovcu. Da bi to ostvario dr. ing. N. Pšenica kroz tri mjeseca je neumorno radio, a osobito se posvetio popularizaciji te Ružičkine proslave, njegovog života i djela, ali na osebujan način, i svoga i Ružičkinog rodnog grada Vukovara. Time je predodredio održavanje današnjeg međunarodnog znanstveno-stručnog skupa „Ružičkini dani“, upravo u Vukovaru!

Osim toga za njegovog mandata predsjednika Jugoslavenskog hemijskog društva, Sekcije u Zagrebu, to društvo je promijenilo ime 5. studenog 1939. u *Hrvatsko kemijsko društvo* koje ime i danas nosi.

Ovime se usmjerilo malo svjetla, na do sada nedovoljno poznatog, još jednog znamenitog Vukovarca, dr. ing. Nikolu Pšenicu.

⁴¹ Malo pokasno obraćanje i postavlja se pitanje tko im je zabranio?

⁴² Nikola PŠENICA - Boravak prof. dra. Lavoslava Ružičke u Zagrebu od 15.-20. III. 1940., *Kemijski vjestnik (Arhiv za kemiju i tehnologiju)*, God. XV i XVI. (1941-42.), str. 124. – 125.

Sekcija: Kemijska analiza i sinteza
Session: Chemical Analysis and Synthesis

Original research paper

Electrochemical characterization of rutin in different electrolytes

Marina Pišonić, Anamarija Šter, Martina Medvidović-Kosanović*

*Josip Juraj Strossmayer University of Osijek, Department of Chemistry,
Cara Hadrijana 8A, 31 000 Osijek, Croatia*

**Corresponding author: mmkosano@kemija.unios.hr*

Summary

Oxido-reduction properties of rutin in three inert electrolytes (KCl, NaCl and LiCl) were studied by cyclic and differential pulse voltammetry. Cyclic voltammograms of rutin revealed two oxidation peaks in all three electrolytes, which were associated with oxidation of four -OH groups of rutin. The first oxidation peak was reversible and it corresponds to the oxidation of the 3',4' - dihydroxy groups on the B-ring of rutin and the second oxidation peak was irreversible and it corresponds to oxidation of 5,7-dihydroxy groups on the A-ring of rutin. Differential pulse voltammograms also revealed two oxidation peaks associated with oxidation of four -OH groups of rutin.

Keywords: rutin, different inert electrolytes, cyclic and differential pulse voltammetry

Introduction

Polyphenols are naturally occurring group of compounds which are responsible for brightly coloured pigments present in a variety of fruits and vegetables and protect plants from diseases and ultraviolet light. Depending on their basic structure, polyphenols can be divided into at least 10 different classes. Flavonoids constitute one of the most important groups and their common structure consists of two aromatic rings linked through three carbons that usually form an oxygenated heterocycle (C₆-C₃-C₆) (Balasundram et al., 2006). Since rutin is a flavonoid glycoside compound with electrochemical activity, electroanalytical techniques have been used for direct detection of rutin, which shows many advantages including high sensitivity, simple and speedy procedure, and low cost equipment with wider dynamic range. In the last three decades electrochemical properties of flavonoids were studied by cyclic voltammetry (Duan et al., 2013, Hu et al., 2012, Ghica et al., 2005; Tian et al., 2008; Zielińska et al., 2008; Medvidović-Kosanović et al., 2010), differential pulse voltammetry (Duan et al., 2013, Volikakis et al., 2000; Kang et al., 2002; Ghica et al., 2005; Medvidović-Kosanović et al., 2010), square-wave voltammetry (Ghica et al., 2005; Zhang et al., 2008; Medvidović-Kosanović et al., 2010), linear sweep voltammetry (Kang et al., 2002; Medvidović-Kosanović et al., 2010), chronocoulometry (Zeng et al., 2006), electrochemical impedance spectroscopy (Hu et al., 2012) and UV spectroelectrochemistry (He et al., 2007). The flavonoid rutin (quercetin-3-O-rutinose) (Fig. 1), also known as vitamin P, is one of the most bioactive flavonoids usually found in plants (especially buckwheat), black tea and apple peels. In humans, it attaches to the iron ion (Fe²⁺), preventing it from binding to hydrogen peroxide and creating a highly reactive free radical that may damage cells.

Kemijska analiza i sinteza / Chemical Analysis and Synthesis

Rutin may have antioxidant, anti-inflammatory, anti-tumor, anti-thrombotic, cardio protective and antibacterial activity (Dufresne et al., 2001).

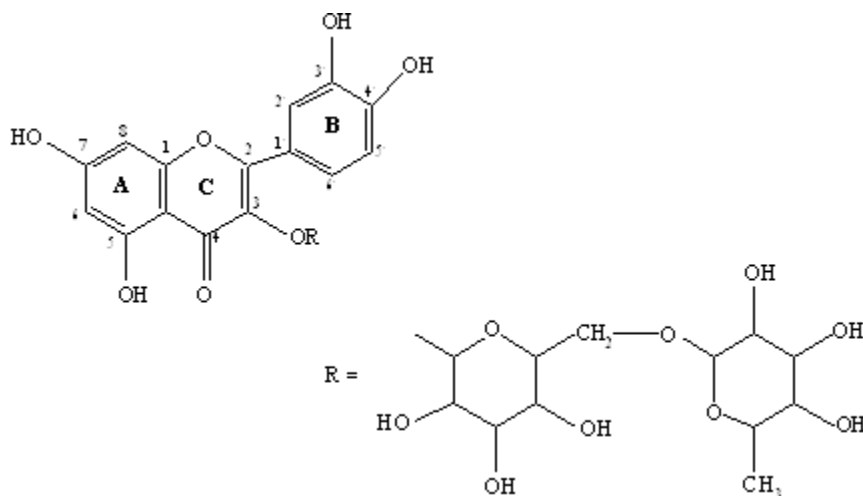

Fig. 1. Chemical structure of rutin

It increases the strength of the walls of blood capillaries and regulates their permeability. Therefore, rutin can reduce the symptoms of many other capillary diseases. In this study, oxido-reduction properties of rutin in three different electrolytes (KCl, NaCl and LiCl) were investigated by cyclic and differential pulse voltammetry.

Materials and Methods

All commercially available chemicals were of reagent grade and used as purchased from commercial sources. Rutin trihydrate ($C_{27}H_{30}O_{16} \cdot 3H_2O$) and Sodium Chloride (NaCl) were obtained from Sigma-Aldrich (St. Louis, MO, SAD). Lithium Chloride (LiCl) was purchased from BDH Prolabo (Leuven, Belgium), Potassium Chloride (KCl) from Kemika (Zagreb, Croatia) and Methanol (CH_3OH) from Carlo Erba (Val de Ruil, France).

Electrochemical experiments were performed on PalmSens potentiostat/galvanostat (PalmSens BV, Utrecht, The Netherlands) driven by PSTrace 4.2 software. A conventional three-electrode cell was used with a glassy carbon as a working electrode, Ag/AgCl as a reference electrode and a platinum wire as a counter electrode. The glassy carbon working electrode was polished with coarse diamond polish (1 μm , ALS, Japan) and with polishing $\alpha-Al_2O_3$ (0.05 μm , ALS, Japan) before each measurement. Cyclic voltammetry scan rate was 100 $mV s^{-1}$. The differential pulse voltammetry conditions were: scan increment 5 mV, pulse amplitude 25 mV, pulse width 70 ms and scan rate 5 $mV s^{-1}$.

Results and Discussion

Cyclic voltammetry studies

Cyclic voltammograms of rutin in three different electrolytes (KCl, NaCl and LiCl) are shown in Fig. 2. All voltammograms revealed two oxidation peaks of rutin, which correspond to oxidation of 4-OH groups of rutin. The first oxidation peak (A1), around 0.39 V corresponds to oxidation of catechol group (3',4'-dihydroxy) at the B-ring of rutin and the second oxidation peak (A2), around 1.0 V corresponds to the oxidation of 5- and 7-hydroxy groups at ring A of rutin. A reduction peak (K1) at potential around 0.36 V corresponds to the reduction of the oxidation product formed in the first anodic peak (Ghica et al., 2005). Obtained ΔE_p value was around 30 mV indicating reversible oxidation reaction which includes transfer of two electrons. Rutin oxidation is a diffusion controlled process since linear dependence was found between anodic peak current and the square root of scan rate ($R^2 = 0.97$) in all three electrolytes (Fig. 3).

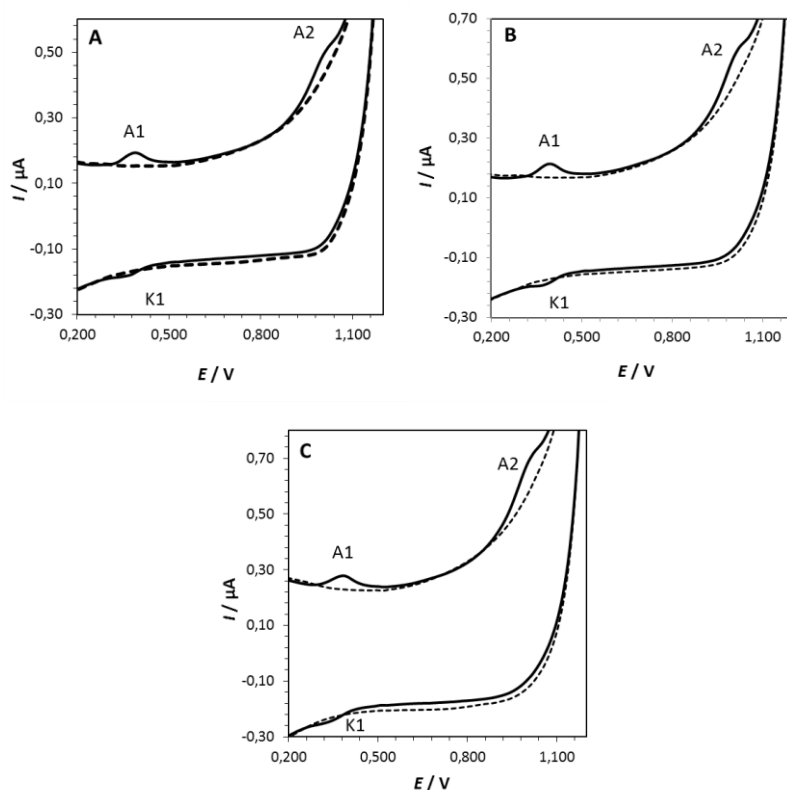

Fig. 2. Cyclic voltammograms of rutin ($c = 1 \cdot 10^{-5} \text{ mol dm}^{-3}$) recorded at glassy carbon electrode, scan rate: 100 mV/s. $I_c = 0.34 \text{ mol dm}^{-3}$ KCl (A), NaCl (B) and LiCl (C). (---) blank, (—) solution with rutin

Kemijska analiza i sinteza / Chemical Analysis and Synthesis

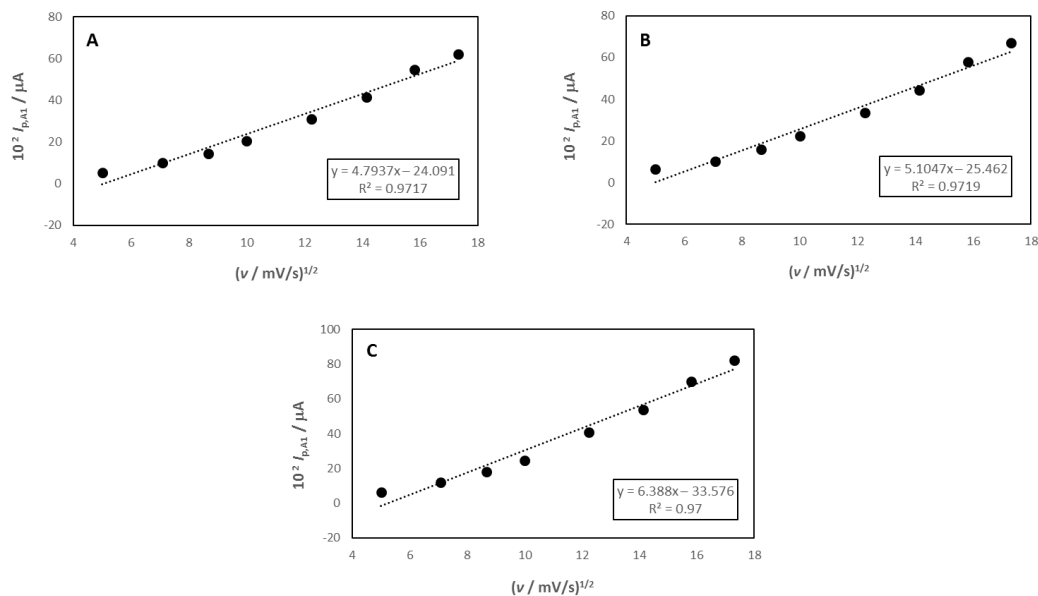

Fig. 3. Anodic peak current of the first oxidation peak ($I_{p,A1}$) of rutin ($c = 1 \cdot 10^{-5} \text{ mol dm}^{-3}$) as a function of the square root of scan rate, $v^{1/2}$. $I_c = 0.34 \text{ mol dm}^{-3}$ KCl (A), NaCl (B) and LiCl (C)

Differential pulse voltammetry studies

Differential pulse voltammograms (Fig. 4) also revealed two oxidation peaks (A1 and A2) in three investigated electrolytes which correspond to oxidation of 4 hydroxy groups in rutin. The first oxidation peak (A1) was around 0.39 V and the second oxidation peak (A2) was around 1.0 V. Oxidation peaks did not change with successive scans which shows that rutin oxidation product did not adsorb on the glassy carbon electrode surface. Peak current and peak potential increased with increasing rutin concentration.

A linear relationship between peak current and rutin concentration was found in concentration range from $1 \cdot 10^{-6} \text{ mol dm}^{-3}$ to $4.2 \cdot 10^{-5} \text{ mol dm}^{-3}$ in all investigated electrolytes (Fig. 5). A linear regression equation, $I_p = 0.2714 c + 0.6181$ ($R^2 = 0.9726$) was found for KCl (Fig. 5A); $I_p = 0.205 c + 0.3711$ ($R^2 = 0.9434$) was found for NaCl (Fig. 5B) and $I_p = 0.1598 c + 0.1315$ ($R^2 = 0.982$) was found for LiCl (Fig. 5C) where I_p is the oxidation peak current ($\cdot 10^{-2} \mu A$) and c is rutin concentration ($\cdot 10^{-6} \text{ mol dm}^{-3}$).

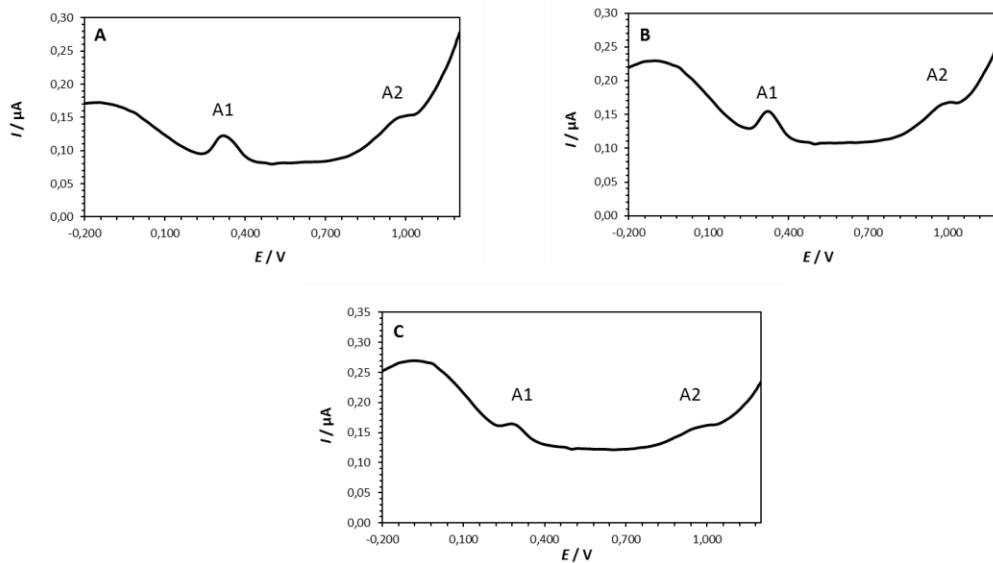

Fig. 4. Differential pulse voltammograms of rutin ($c = 1 \cdot 10^{-5}$ mol dm^{-3}) recorded at glassy carbon electrode, scan rate: 5 mV/s. $I_c = 0.34$ mol dm^{-3} KCl (A), NaCl (B) and LiCl (C)

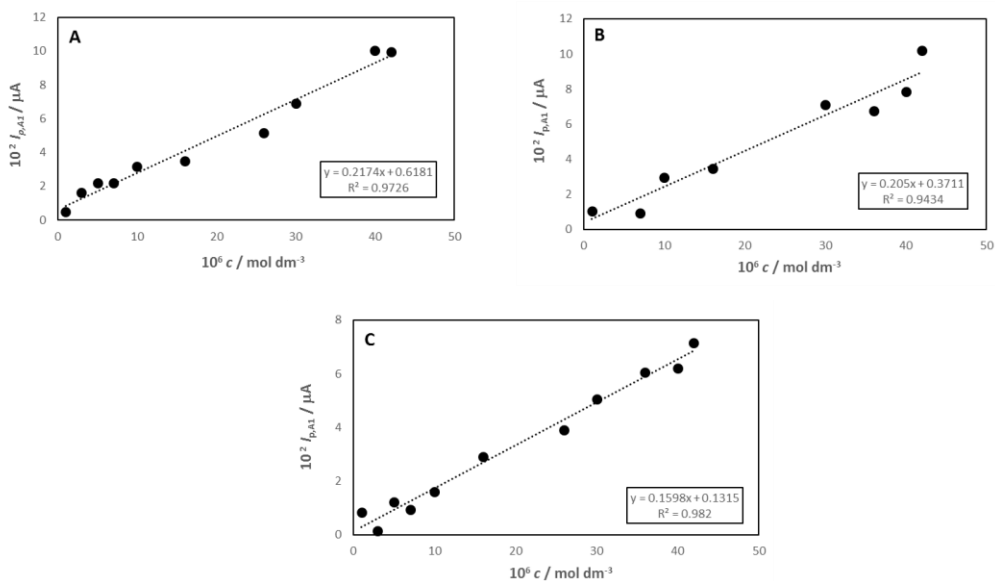

Fig. 5. Anodic peak current of the first oxidation peak ($I_{p,A1}$) of rutin as a function of rutin concentration, scan rate: 5 mV/s. $I_c = 0.34$ mol dm^{-3} KCl (A), NaCl (B) and LiCl (C)

Conclusions

In this study electrochemical properties of rutin in three electrolytes (KCl, NaCl and LiCl) were investigated. Two oxidation peaks in all three electrolytes have appeared, which were associated with oxidation of four -OH groups of rutin. The first oxidation peak was reversible and it corresponds to the oxidation of the 3',4'- dihydroxy groups on the B-ring of rutin and the second oxidation peak was irreversible and it corresponds to oxidation of 5,7-dihydroxy groups on the A-ring of rutin. A linear relationship between peak current and rutin concentration was found in concentration range from $1 \cdot 10^{-6}$ mol to $4.2 \cdot 10^{-5}$ mol dm⁻³ in all investigated electrolytes.

References

- Balasundram, N. et al. (2006): Phenolic compounds in plants and agri-industrial by-products: Antioxidant activity, occurrence and potential uses, *Food Chem.* 99, 191-203.
- Duan, L., Yang, L., Xiong, H., Zhang, X., Wang, S. (2013): Studies on the electrochemistry of rutin and its interaction with bovine serum albumin using a glassy carbon electrode modified with carbon-coated nickel nanoparticles, *Microchim. Acta* 180 (5), 355-361.
- Dufresne, C. J., Farnworth, E. R. (2001): A review of latest research findings on the health promotion properties of tea, *J. Nutr. Biochem.* 12 (7), 404-421.
- Ghica, M.-E., Oliveira Brett, A. M. (2005): Electrochemical oxidation of rutin, *Electroanalysis* 17 (4), 313-318.
- He, J.-B. et al. (2007): Study of the adsorption and oxidation of antioxidant rutin by cyclic voltammetry-voltabsorptometry, *Bioelectrochemistry* 71 (2), 157-163.
- Hu, S. et al. (2012): Electrochemical detection of rutin with a carbon ionic liquid electrode modified by Nafion, graphene oxide and ionic liquid composite, *Microchim. Acta* 178 (1), 211-219.
- Kang, J., Lu, X., Zeng, H., Liu, H., Lu, B. (2002): Investigation on the electrochemistry of rutin and its analytical application, *Anal. Lett.* 35 (4), 677-686.
- Medvidović-Kosanović, M. et al. (2010): Electrochemical and antioxidant properties of (+)-catechin, quercetin and rutin, *Croat. Chem. Acta.* 83 (2), 197-207.
- Medvidović-Kosanović, M., Šeruga, M., Jakobek, L., Novak, I. (2010): Electrochemical and antioxidant properties of rutin, *Collect. Czech. Chem. Commun.* 75 (5), 547-561.
- Tian, X., Li, F., Zhu, L., Ye, B. (2008): Study on the electrochemical behavior of anticancer herbal drug rutin and its interaction with DNA, *J. Electroanal. Chem.* 621, 1-6.
- Volikakis, G. J., Efstathiou, C. E. (2000): Determination of rutin and other flavonoids by flow-injection/adsorptive stripping voltammetry using nujol-graphite and diphenylether-graphite paste electrodes, *Talanta* 51 (4), 775-785.
- Zeng, B., Wei, S., Xiao, F., Zhao, F. (2006): Voltammetric behavior and determination of rutin at a single walled carbon nanotubes modified gold electrodes, *Sens. Actuators, B* 115, 240-246.
- Zhang, Y., Zheng, J. (2008): Sensitive voltammetric determination of rutin at an ionic liquid modified carbon paste electrode, *Talanta* 77, 325-330.
- Zielińska, D., Wiczkowski, W., Piskula, M. K. (2008): Determination of the relative contribution of quercetin and its glucosides to the antioxidant capacity of onion by cyclic voltammetry and spectrophotometric methods, *J. Agric. Food Chem.* 56, 3524-3531.

Optimizacija HPLC metode određivanja sadržaja vitamina

Valerija Bukvić^{1*}, Sunčica Čoklica¹, Darko Kantoci², Jasmina Ranilović¹,
Vesna Popijač¹, Tanja Paveli¹

¹Podravka d.d., A. Starčevića 32, 48 000 Koprivnica, Hrvatska

²ValDar International, 1731 SE 15th Street, Suite 408, Fort Lauderdale, FL 33316, USA

*Dopisni autor: valerija.bukvic@podravka.hr

Sažetak

Vitamini su biološki aktivne komponente koje pomažu u održavanju zdravlja i regulaciji rasta i razvoja organizma. Budući da se hrana obogaćuje vitaminima, od izuzetne važnosti za laboratorije subjekata u poslovanju s hranom je njihova detekcija i kvantifikacija. Cilj istraživanja je optimizacija metode određivanja sadržaja dodanih vitamina B skupine na referentnom materijalu žitarica za doručak. Princip metode je ekstrakcija vitamina kiselinskom hidrolizom, a sadržaj je određen primjenom tekućinske kromatografije visoke djelotvornosti (HPLC) uz reverzno faznu kolonu i fluorescentni detektor. Za vitamin B₁ je dodatno provedena oksidacija alikvotnog dijela u tiokrom uz ekstrakciju izobutanolom, a za niacin post-kolonska derivatizacija UV zračenjem u prisustvu bakrenog(II)iona i vodikovog peroksida. Optimizacija je uključivala varijaciju vremena autoklaviranja (5, 10, 15, 30 minuta), smanjenje odvaga uzorka i volumena otapala. Ovim radom razvijena je jednostavna i brza metoda za određivanje dodanih vitamina B skupine u uzorke žitarica za doručak. Optimizirana metoda je validirana s obzirom na linearnost, preciznost i točnost, a vanjska ocjena kvalitete rezultata ispitivanja dokazana sudjelovanjem u testovima sposobnosti. Provedena optimizacija metode određivanja sadržaja vitamina B skupine pozitivno je utjecala na efikasnost rada laboratorija.

Ključne riječi: vitamini B skupine, optimizacija metode, testovi sposobnosti

Uvod

Vitamini su organski, esencijalni nutrijenti koji su organizmu potrebni u malim količinama. Imaju brojne uloge u organizmu i sudjeluju u odvijanju funkcija koje potiču rast, razvoj i održavanje zdravlja. Vitamini B skupine su vitamini topivi u vodi, a neki od njih (tiamin – B₁, riboflavin – B₂, niacin, pantotenska kiselina i biotin) dio su koenzima (malih organskih molekula) koji pomažu enzimima u oslobađanju i iskorištavanju energije iz ugljikohidrata, masti i proteina, dok vitamin B₆ pomaže enzimima koji metaboliziraju aminokiseline. Simptomi nedostatka vitamina B direktno utječu na neravnotežu metabolizma nastalu zbog nedostatka koenzima čiji su dio. Nedostatak vitamina B skupine u organizmu predstavlja rizik za zdravlje jer može rezultirati raznim bolestima (nedostatak vitamina B₁ beriberi; vitamina B₂ upalni procesi u ustima, očima, na koži; niacina – pelagra; vitamina B₆ – dermatitis, zbunjenost, anemija), stoga je važno unositi ih uravnoteženom prehranom (Whitney i Rady Rolfes, 2008).

Kemijska analiza i sinteza / Chemical Analysis and Synthesis

Osim identifikacije vitamina B skupine u hrani, važna je i njihova kvantifikacija (Gratzfeld-Hüsgen i Schuster, 2001). Za kvantifikaciju vitamina B skupine optimizirana je postojeća metoda visoko djelotvorne tekućinske kromatografije koja je temeljena na normiranim metodama određivanja vitamina (HRN EN 14122:2003/AC:2005, HRN EN 14152:2003, HRN EN 15652:2009, HRN EN 14164:2002). Ekstrakcija se provodi dodatkom klorovodične kiseline $c=0,1 \text{ mol/dm}^3$. Vrijeme ekstrakcije je 30 minuta. Doda se natrijev acetat $c=2,5 \text{ mol/dm}^3$ i takadiastaza nakon čega slijedi inkubacija uzorka u trajanju od 1 h do 17 h. Svi uzorci se nadopunjavaju demineraliziranom vodom. Za analizu vitamina B₁ potrebno je dodatno provesti oksidaciju tiamina u tiokrom u određenom volumenu uzorka za analizu vitamina B₂, B₆ i niacina, uz dodatak otopine kalij fericianida gustoće $0,4 \text{ g/dm}^3$. Ekstrakcija se provodi izobutanolom.

Optimizirana metoda mora biti validirana prije nego se može smatrati uključenom unutar definiranog opsega. Glavni cilj validacije metode je dokazati da je metoda sposobna riješiti postavljenu zadaću te da rezultat ima prihvatljivu nesigurnost, tj. da je analitička metoda prikladna namijenjenoj svrsi. Struka, regulativa i zakonodavstvo prihvatili su osam osnovnih parametara validacije: selektivnost; linearnost; područje; preciznost (*ponovljivost, međupreciznost, obnovljivost*); točnost; granica kvantifikacije; granica detekcije i postojanost (Lazarić. 2012).

Cilj istraživanja bio je optimizirati postojeću metodu određivanja sadržaja dodanih vitamina B skupine na matriksu referentnog materijala žitarica za doručak. Optimizirani su parametri koji bi mogli utjecati na metodu: odvaga uzorka i trajanje ekstrakcije. Varirano je vrijeme autoklavanja (5, 10, 15 i 30 minuta), a odvaga uzorka i volumeni korištenih otapala su smanjeni. Razvijena optimizirana metoda je djelomično validirana s obzirom na linearnost, preciznost i točnost, a dobiveni rezultati su potvrđeni sudjelovanjem u testovima sposobnosti (*eng. Proficiency test*).

Za testove sposobnosti korišten je program međulaboratorijskih usporedbi iz područja kemije hrane - FAPAS (Food Analysis Performance Assessment Scheme). Testovi sposobnosti su esencijalni dio postupka laboratorijske kontrole. Sudjelujući u ovim testovima korisnici dobivaju povjerenje u korištenu laboratorijsku opremu, metode i osoblje, te sigurnost da daju kvalitetne rezultate koje traže njihovi korisnici (FAPAS, 2015).

U ovom radu opisana je jednostavna i brza metoda za određivanje vitamina B skupine dodanih u uzorke žitarica za doručak.

Materijali i metode

Eksperimentalni dio istraživanja je proveden u Podravki d.d. u Kontroli kvalitete u Centralnom fizikalno kemijskom laboratoriju 2014. godine.

Materijali

Za istraživanje se koristio uzorak referentnog materijala Breakfast Cereal T2186. Korišteni su standardi vitamina B₁, B₆, nikotinamida i nikotinske kiseline (Dr. Ehrenstorfer GmbH) i B₂ (ChromaDex). Od ostalih materija korišteni su demineralizirana voda, otopina klorovodične kiseline ($c=0,1 \text{ mol/dm}^3$), otopina natrijevog acetata ($c=2,5 \text{ mol/dm}^3$), 10% vodena otopina takadiastaze, otopina kalijeva fericianida (1% otopina u 15% natrijevom hidroksidu), izobutanol, filter papir crna vrpca, filter poroziteta $0,45 \mu\text{m}$, ekspres lonac (kao autoklav), vodena kupelj s mogućnošću regulacije temperature, centrifuga.

Za određivanje vitamina korištene su kolone obrnutih faza (C18), lampa za post-kolonsku derivatizaciju (Black light tube 300-400 nm, 18 W, 230 V, Philips TL-D18W/08) i PTFE kapilara (duljina 15 m, unutarnjeg promjera 0,5 mm), kromatografski sustav (pumpa, fluorescentni detektor, autosampler proizvođača Varian).

Analiza vitamina B skupine

Priprema standarda vitamina B₂ i B₆

Pripremi se početna otopina standarda vitamina B₂ i B₆ u 0,1 mol/dm³ klorovodičnoj kiselini koncentracije 0,1 mg/cm³. Radna otopina standarda koncentracije 1 µg/cm³ priprema se s demineraliziranom vodom.

Priprema standarda vitamina B₁

Pripremi se početna otopina standarda vitamina B₁ u 0,1 mol/dm³ sumporovodičnoj kiselini koncentracije 0,15 mg/cm³. Pripremi se razrijeđena otopina standarda s 0,1 mol/dm³ sumporovodičnom kiselinom koncentracije 1,5 µg/cm³. Za pripremu radne otopine standarda provede se oksidacija kako je opisano u točki postupku Priprema uzoraka za analizu vitamina B₁.

Priprema standarda nikotinske kiseline i nikotinamida

Pripremi se početna otopina standarda nikotinske kiseline i nikotinamida koncentracije 1 mg/cm³. Radna otopina standarda sadrži 1 µg/cm³ nikotinske kiseline i 4 µg/cm³ nikotinamida. Sve otopine standarda pripremaju se s demineraliziranom vodom.

Priprema uzoraka za analizu vitamina B₂, B₆ i niacina

Važe se 1 g uzorka u kivetu od tamnosmeđeg stakla. Doda se 10 ml otopine klorovodične kiseline c=0,1 mol/dm³. Kivete se postave u stalak posebno izrađen za analizu vitamina B skupine. Uzorak se autoklavira 30 minuta, hladi i pipetira se 8 ml demineralizirane vode, 8 ml otopine natrijeva acetata c=2,5 mol/dm³, 2 ml 10 % vodene otopine takadiastaze, termostatira 30 minuta/40°C i filtrira.

Priprema uzoraka za analizu vitamina B₁

Za analizu vitamina B₁ 2 ml otopine uzorka dobivene za analizu vitamina B₂ i B₆ se oksidira i ekstrahira u kiveti za centrifugu s 2 ml kalijevoeg fericijanida i 4 ml izobutanola. Sadržaj se miješa 2 minute, centrifugira 5 minuta na 3000 okretaja, a dobiveni izobutanolni sloj se koristi za injiciranje.

HPLC analiza

Sadržaj vitamina je određen HPLC tehnikom uz reverzno faznu kolonu, fluorescentni detektor s karakterističnim valnim duljinama za određivanje vitamina a u slučaju niacina između kolone i detektora se dodatno postavi lampa za post-kolonsko UV zračenje oko koje je namotana PTFE kapilara. Kromatografski uvjeti za analizu vitamina B₂ i B₆ uključuju mobilnu fazu koja se sastoji od 150 ml acetonitrila i 850 ml otopine 1,62 g natrij oktansulfonata i 5,5 ml trietilamina otopljenog u demineraliziranoj vodi uz podešen pH 3 s o-fosfornom kiselinom. Postavljeni protok je 1,5 ml/min, a valne duljine ekscitacije i emisije za vitamin B₂ su 422 nm i 525 nm, te za B₆ 300 nm i 400 nm.

Kemijska analiza i sinteza / Chemical Analysis and Synthesis

Mobilna faza za vitamin B₁ sastoji se od 600 ml metanola pomiješanog s demineraliziranom vodom uz dodatak 10% octene kiseline i 5 ml 40% vodene otopine tetrabutilamonij hidroksida. Protok je 1,5 ml/min, a valne duljine ekscitacije i emisije za vitamin B₁ su 375 nm i 435 nm.

Mobilna faza za niacin sastoji se od 4,77 g kalijeveg dihidrogen fosfata otopljenog u demineraliziranoj vodi uz dodatak 0,5 ml otopine bakrovog sulfata pentahidrata $c=0,005 \text{ ml/dm}^3$ i 3,8 ml 30 % vodikovog peroksida, te se dopuni do 500 ml demineraliziranom vodom. Protok je 2,0 ml/min, a valne duljine ekscitacije i emisije za niacin su 322 nm i 380 nm. Separacija svih vitamina je provedena pri sobnoj temperaturi, a injicirani volumen uzoraka je 20 μl .

Statistička obrada

Rezultati vitamina su kvantificirani primjenom Star kromatografskog Softwarea (Varian Star Ver. 6.41). Linearnost je izračunata Software-om. Rezultati su obrađeni primjenom programa Microsoft Excel. Količina svakog vitamina je izražena u mg/100 g uzorka. Rezultati su izraženi kao srednja vrijednost sadržaja vitamina u mg/100 g i z-vrijednost.

Rezultati i rasprava

Rezultati analize vitamina B₁, B₂, B₆ i niacina dobiveni optimiziranom metodom su prikazani u Tablici 1. i na Slikama 1. - 4. Odvage uzorka referentnog materijala su smanjene s 5 - 10 grama, koje preporučuju normirane metode, na 1 gram. Volumeni korištenih otapala su također smanjeni 5 puta. Vrijednosti vitamina B₁, B₂, B₆ i niacina izražene u mg/100 g i dobivene u referentnom materijalu žitarica za doručak, s obzirom na vrijeme trajanja autoklavliranja prikazane su u Tablici 1. Analiza uzorka referentnog materijala provedena je pri različitoj duljini trajanja vremena autoklavliranja i to 3 puta pri vremenu od 5 i 15 minuta, 4 puta pri vremenu 10 minuta, te 1 put pri vremenu 30 minuta. Ciljana vrijednost sadržaja vitamina B₁ u uzorku referentnog materijala je 1,32 mg/100 g. Iz Tablice 1. vidljiva je dobivena srednja vrijednost sadržaja vitamina B₁ optimizacijom metode koja je nakon 5 minuta iznosila 1,22 mg/100 g, nakon 10 minuta 1,23 mg/100 g, nakon 15 minuta 1,27 mg/100 g i nakon 30 minuta autoklavliranja 1,28 mg/100 g. Tablica prikazuje i srednje z-vrijednosti vitamina B₁ od - 0,7 nakon 5 minuta autoklavliranja do - 0,3 nakon 15 i 30 minuta autoklavliranja.

Slika 1. prikazuje z-vrijednosti vitamina B₁ u referentnom materijalu nakon provedene optimizacije. Raspon z-vrijednosti je od - 0,9 za drugu probu uzorka nakon 10 minuta autoklavliranja do - 0,2 za treću probu uzorka nakon 15 minuta autoklavliranja.

Tablica 1. prikazuje i vrijednosti vitamina B₂ izražene u mg/100 g dobivene u referentnom materijalu žitarica za doručak s obzirom na vrijeme trajanja autoklavliranja. Ciljana vrijednost sadržaja vitamina B₂ u uzorku referentnog materijala je 1,47 mg/100 g. Nakon provedene optimizacije metode dobiveni su slični rezultati. Iz Tablice 1. vidljiva je dobivena srednja vrijednost sadržaja vitamina B₂ koja je nakon 5 minuta iznosila 1,42 mg/100 g, nakon 10 minuta 1,41 mg/100 g, 1,43 mg/100 g nakon 15 minuta i 1,45 mg/100 g nakon 30 minuta autoklavliranja. Srednje z-vrijednosti vitamina B₂ su od - 0,3 nakon 5, 10 i 15 minuta autoklavliranja do - 0,1 nakon 30 minuta autoklavliranja.

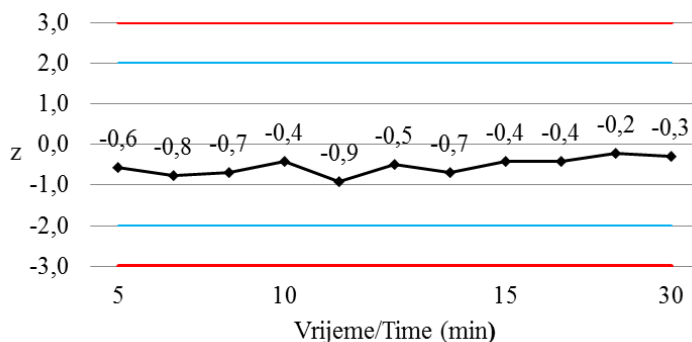

Slika 1. z-vrijednosti vitamina B₁ u referentnom materijalu žitarica za doručak dobivene optimiziranom metodom

Fig. 1. z-scores of vitamin B₁ in breakfast cereals reference material obtained with optimized method

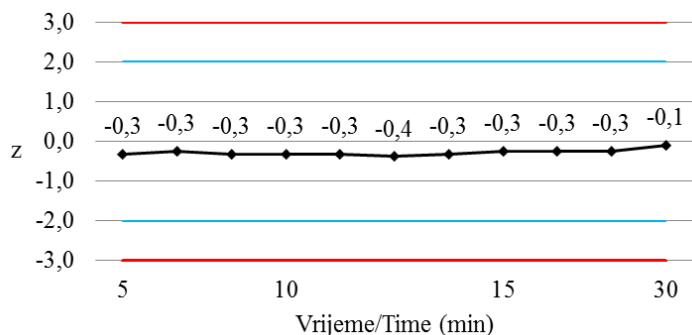

Slika 2. z-vrijednosti vitamina B₂ u referentnom materijalu žitarica za doručak dobivene optimiziranom metodom

Fig. 2. z-scores of vitamin B₂ in breakfast cereals reference material obtained with optimized method

Slika 2. prikazuje z-vrijednosti vitamina B₂ u referentnom materijalu nakon provedene optimizacije. Raspon z-vrijednosti je od -0,4 za treću probu uzorka nakon 10 minuta autoklaviranja do -0,1 za probu uzorka nakon 30 minuta autoklaviranja. Vrijednosti vitamina B₆ izražene u mg/100 g i dobivene u referentnom materijalu žitarica za doručak s obzirom na vrijeme trajanja autoklaviranja prikazane su također u Tablici 1. Ciljana vrijednost sadržaja vitamina B₆ u uzorku referentnog materijala je 2,69 mg/100 g. Nakon provedene optimizacije metode dobiveni su slični rezultati. Iz Tablice 1. vidljiva je dobivena srednja vrijednost sadržaja vitamina B₆ koja je nakon 5 minuta iznosila 2,31 mg/100 g, nakon 10 minuta 2,37 mg/100 g, 2,33 mg/100 g nakon 15 minuta i 2,57 mg/100 g nakon 30 minuta autoklaviranja. Srednje z-vrijednosti vitamina B₆ kreću se u rasponu od -1,4 nakon 5 i 15 minuta autoklaviranja do -0,5 nakon 30 minuta autoklaviranja, što je vidljivo iz Tablice 1.

Kemijska analiza i sinteza / Chemical Analysis and Synthesis

Tablica 1. Srednje vrijednosti vitamina B₁, B₂, B₆ i niacina u mg/100 g dobivene u referentnom materijalu žitarica za doručak s obzirom na vrijeme (min) trajanja autoklavliranja i njihove z-vrijednosti.

Table 1. Mean values of vitamin B₁, B₂, B₆ and niacin (mg/100 g) obtained in breakfast cereals reference material regarding to autoclaving time (min) and their z-scores.

Analit/ Analyte	Vrijeme autoklavliranja/ Autoclaving time	Srednja vrijednost/ Mean value	Ciljana vrijednost/ Assigned value	Donja granica/ Lower limit	Gornja granica/ Upper limit	z
B ₁	5	1,22	1,32	1,03	1,61	-0,7
	10	1,23	1,32	1,03	1,61	-0,6
	15	1,27	1,32	1,03	1,61	-0,3
	30	1,28	1,32	1,03	1,61	-0,3
B ₂	5	1,42	1,47	1,16	1,79	-0,3
	10	1,41	1,47	1,16	1,79	-0,3
	15	1,43	1,47	1,16	1,79	-0,3
	30	1,45	1,47	1,16	1,79	-0,1
B ₆	5	2,31	2,69	2,16	3,21	-1,4
	10	2,37	2,69	2,16	3,21	-1,2
	15	2,33	2,69	2,16	3,21	-1,4
	30	2,57	2,69	2,16	3,21	-0,5
Niacin	5	14,54	15,30	13,00	17,60	-0,7
	10	13,91	15,30	13,00	17,60	-1,2
	15	14,26	15,30	13,00	17,60	-0,9
	30	16,12	15,30	13,00	17,60	0,7

Slika 3. prikazuje z-vrijednosti vitamina B₆ u referentnom materijalu nakon provedene optimizacije. Raspon z-vrijednosti je od - 1,6 za treću probu uzorka nakon 5 minuta autoklavliranja do - 0,5 za probu uzorka nakon 30 minuta autoklavliranja.

Tablica 1. prikazuje i vrijednosti niacina izražene u mg/100 g dobivene u referentnom materijalu žitarica za doručak s obzirom na vrijeme trajanja autoklavliranja. Ciljana vrijednost sadržaja niacina u uzorku referentnog materijala je 15,30 mg/100 g. Nakon provedene optimizacije metode dobiveni su slični rezultati. Iz Tablice 1. vidljiva je dobivena srednja vrijednost sadržaja niacina koja je nakon 5 minuta iznosila 14,54 mg/100 g, nakon 10 minuta 13,91 mg/100 g, 14,26 mg/100 g nakon 15 minuta i 16,12 mg/100 g nakon 30 minuta autoklavliranja, dok su se srednje z-vrijednosti niacina kretale u rasponu od - 1,2 nakon 10 minuta autoklavliranja do 0,7 nakon 30 minuta autoklavliranja.

Slika 4. prikazuje z-vrijednosti niacina u referentnom materijalu nakon provedene optimizacije. Raspon z-vrijednosti je od - 1,8 za četvrtu probu uzorka nakon 10 minuta autoklavliranja do 0,7 za probu uzorka nakon 30 minuta autoklavliranja.

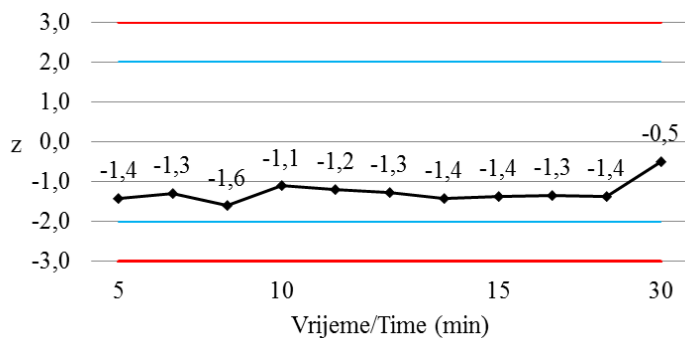

Slika 3. z-vrijednosti vitamina B₆ u referentnom materijalu žitarica za doručak dobivene optimiziranom metodom

Fig. 3. z-scores of vitamin B₆ in breakfast cereals reference material obtained with optimized method

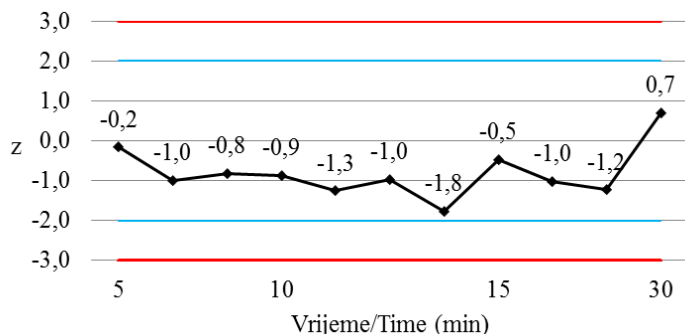

Slika 4. z-vrijednosti niacina u referentnom materijalu žitarica za doručak dobivene optimiziranom metodom

Fig. 4. z-scores of niacin in breakfast cereals reference material obtained with optimized method

Tablica 2. prikazuje rezultate p-testa iz 2015. godine na uzorku žitarica za doručak u kojem je sudjelovao Centralni-fizikalno kemijski laboratorij. Iz Tablice 2. je vidljivo da je ciljane vrijednosti vitamina B₁ iznosila 1,18 mg/100 g, za vitamin B₂ 1,77 mg/100 g, vitamin B₆ 2,01 i za niacin 18,20 mg/100 g. Nakon optimizacije procesa, koji je osim smanjenja odvage uzorka i volumena korištenih otapala uključio i skraćivanje vremena autoklaviranja na 10 minuta, dobiveni su sljedeći rezultati: vitamin B₁ 1,09 mg/100 g, B₂ 1,73 mg/100 g, B₆ 1,98 mg/100 g i niacin 17,50 mg/100 g. Njihove z-vrijednosti su redom - 0,7; - 0,2; - 0,1 i - 0,5.

Tablica 3. prikazuje z-vrijednost akreditiranih, neakreditiranih i nerazvrstanih laboratorija za uzorak referentnog materijala žitarica za doručak 2015. godine.

Kemijska analiza i sinteza / Chemical Analysis and Synthesis

Tablica 2. Rezultati p-testa 2015. godine, uzorak žitarice za doručak
Table 2. Results of p-test from 2015 in breakfast cereals reference material

Analit/ <i>Analyte</i>	Vrijeme autoklaviranja/ <i>Autoclaving time</i>	Srednja vrijednost/ <i>Mean value</i>	Ciljana vrijednost/ <i>Assigned value</i>	Donja granica/ <i>Lower limit</i>	Gornja granica/ <i>Upper limit</i>	z
B ₁	10	1,09	1,18	0,92	1,44	-0,7
B ₂	10	1,73	1,77	1,40	2,13	-0,2
B ₆	10	1,98	2,01	1,60	2,42	-0,1
Niacin	10	17,50	18,20	15,50	20,80	-0,5

Tablica 3. z-vrijednost akreditiranih, neakreditiranih i nerazvrstanih laboratorija za uzorak referentnog materijala žitarica za doručak 2015. godine
Table 3. z-values of accredited, non-accredited and non-classified laboratories in breakfast cereals reference material from 2015

Analit/ <i>Analyte</i>	z	Akreditiran/ <i>Accredited</i>	Neakreditiran/ <i>Non-accredited</i>	Nerazvrstan/ <i>Non-classified</i>
B ₁	$ Z \leq 2$	22	8	11
	$ Z > 2$	4	2	9
	² $ Z \leq 2$ (%)	39,29	14,29	19,64
	² $ Z > 2$ (%)	7,14	3,57	16,07
B ₂	$ Z \leq 2$	22	7	17
	$ Z > 2$	3	2	4
	² $ Z \leq 2$ (%)	40,00	12,73	30,91
	² $ Z > 2$ (%)	5,45	3,64	7,27
B ₆	$ Z \leq 2$	14	5	9
	$ Z > 2$	6	1	5
	² $ Z \leq 2$ (%)	35	12,5	22,5
	² $ Z > 2$ (%)	15	2,5	12,5
Niacin	$ Z \leq 2$	16	3	11
	$ Z > 2$	2	4	3
	² $ Z \leq 2$ (%)	41,03	7,69	28,21
	² $ Z > 2$ (%)	5,13	10,26	7,69

²Udio laboratorija / *Laboratory percentage*

Iz Tablice 3. je vidljiv ukupan broj laboratorija koji su sudjelovali u p-testu, a koji je iznosio redom 56, 55, 40 i 39 za vitamine B₁, B₂, B₆ i niacin. Centralni-fizikalno kemijski laboratorij nije akreditirani laboratorij, no unatoč tome vanjska ocjena kvalitete rezultata ispitivanja dokazana je sudjelovanjem u testovima sposobnosti što je vidljivo iz ranije spomenute Tablice 2. Od 10 neakreditiranih laboratorija koji su prijavili rezultate za vitamin B₁, 8 tj. 14,29 % je imalo z-vrijednost ≤ 2 . Nadalje, 9 neakreditiranih laboratorija koji su prijavili rezultate za vitamin B₂, 7 tj. 12,73 % je imalo z-vrijednost ≤ 2 . Od 6 neakreditiranih laboratorija koji su prijavili rezultate za vitamin B₆, 5 tj. 12,5 % je imalo z-vrijednost ≤ 2 , a od 7 neakreditiranih laboratorija koji su prijavili rezultate za niacin, 3 tj. 7,69 % je imalo z-vrijednost ≤ 2 .

Tablica 4. Ponovljivost pripreme uzorka (%RSD), ponovljivost injiciranja uzorka (%RSD) i točnost (%) na referentnom materijalu žitarica za doručak

Table 4. Repeatability of breakfast cereals reference material sample preparation (%RSD), sample injection (%RSD) and trueness (%)

Analit/ <i>Analyte</i>		Parametar/Parameter			z
		Preciznost/Precision		Točnost/ <i>Trueness</i>	
		Ponovljivost pripreme uzorka RM ¹ / <i>Repeatability of RM¹ sample preparation</i>	Ponovljivost injiciranja uzorka RM ¹ / <i>Repeatability of RM¹ sample injection</i>		
B ₁	Kriterij prihvatljivosti/ <i>Acceptability criterion</i>	$\leq 7,3$	≤ 5	80-110	-0,9
	Rezultat/ <i>Result</i>	1,91	0,92	89,9	
B ₂	Kriterij prihvatljivosti/ <i>Acceptability criterion</i>	$\leq 7,3$	≤ 5	80-110	-0,5
	Rezultat/ <i>Result</i>	1,76	2,67	95,1	
B ₆	Kriterij prihvatljivosti/ <i>Acceptability criterion</i>	$\leq 7,3$	≤ 5	80-110	-1,4
	Rezultat/ <i>Result</i>	2,01	1,32	92,0	
Niacin	Kriterij prihvatljivosti/ <i>Acceptability criterion</i>	$\leq 5,3$	≤ 5	80-110	0,1
	Rezultat/ <i>Result</i>	3,58	/	101,1	

¹RM – referentni materijal/*reference material*

Kemijska analiza i sinteza / Chemical Analysis and Synthesis

Tablica 4. prikazuje vrijednosti parametara preciznosti i točnosti vitamina B₁, B₂, B₆ i niacina dobivene nakon provedene optimizacije metode kao i dobivenu z-vrijednost. Ispitivanje parametara preciznosti provedeno je ispitivanjem ponovljivosti pripreme uzoraka referentnog materijala i ponovljivosti injiciranja uzoraka referentnog materijala. Otopine uzoraka pripremljene su u osam proba prema uputama opisanim u metodi određivanja.

U Tablici 4. su navedeni kriteriji prihvatljivosti i dobiveni rezultati za svaki vitamin. RSD ponovljivost pripreme uzorka referentnog materijala iznosi za vitamin B₁ 1,91 % , za vitamin B₂ 1,76 % , za vitamin B₆ 2,01 % i za niacin 3,58 %. Za određivanje ponovljivosti injiciranja uzorak je injiciran osam puta. RSD ponovljivosti injiciranja uzorka referentnog materijala iznosi 0,92 % za vitamin B₁, 2,67 % za vitamin B₂, 1,32 % za vitamin B₆ dok za niacin nije određena. Navedeno je u skladu s postavljenim kriterijima prihvatljivosti. Točnost je određena pripremom uzorka referentnog materijala žitarica za doručak prema opisanoj metodi u osam paralela. Točnost za vitamin B₁ iznosi 89,9 %, za vitamin B₂ 95,1 %, vitamin B₆ 92,0 % i za niacin 101,1 %. Dobivena točnost je u skladu s postavljenim kriterijima prihvatljivosti. Dobivene z-vrijednosti za vitamin B₁, vitamin B₂, vitamin B₆ i niacin redom iznose - 0,9; - 0,5; - 1,4 i 0,1.

Zaključci

Provedenim ispitivanjem dobiveni su sljedeći zaključci:

Smanjenje odvage uzorka referentnog materijala žitarica za doručak i volumena korištenih otapala nisu utjecali na rezultat dobiven optimiziranom metodom.

Vrijeme trajanja autoklaviranja nije bitno utjecalo na rezultate ispitivanja.

Relativne standardne devijacije za ponovljivost pripreme uzorka, ponovljivost pripreme standarda i ponovljivosti injiciranja ukazuju da je preciznost analitičkog mjerenja zadovoljavajuća.

Iskorištenja metode dobivena analizom referentnog materijala potvrđuju točnost primijenjene optimizirane metode.

Vanjska ocjena kvalitete rezultata ispitivanja dokazana je sudjelovanjem u testovima sposobnosti.

Optimizirana metoda omogućila je obradu većeg broja uzoraka u istom vremenu uz manji utrošak materijala što je pozitivno utjecalo na efikasnost rada laboratorija.

Literatura

FAPAS (2015): Quality control materials, UK: Fera Sand Hutton, York. Dostupno na: <http://fapas.com/quality-control-materials/>. Pristupljeno 30. svibnja 2016.

Gratzfeld-Hüsgen, A., Schuster, R. (2001): HPLC For food analysis: A Primer, Germany: Agilent Technologies Company, pp. 42-44.

HRN EN 14122:2003/AC:2005, Foodstuffs – Determination of vitamin B1 by HPLC.

HRN EN 14152:2003, Foodstuffs – Determination of vitamin B2 by HPLC.

HRN EN 14164:2002, Foodstuffs – Determination of vitamin B6 by HPLC.

HRN EN 15652:2009, Foodstuffs – Determination of niacin by HPLC.

Lazarić, K. (2012): Validacija analitičkih metoda – osnovna načela, *Svijet po mjeri* 1 (1), pp. 61-64.

Whitney, E., Rady Rolfes, S. (2008): The Water Soluble Vitamins: B Vitamins and Vitamin C. In: Understanding nutrition, (11 ed.), Belmont, USA: Thompson Wadsworth, pp. 323-365.

Science note

Optimization of HPLC method for determination of vitamin content

Valerija Bukvić^{1*}, Sunčica Čoklica¹, Darko Kantoci², Jasmina Ranilović¹,
Vesna Popijač¹, Tanja Paveli¹

¹Podravka d.d., A. Starčevića 32, 48 000 Koprivnica, Croatia

²ValDar International, 1731 SE 15th Street, Suite 408, Fort Lauderdale, FL 33316, USA

*Corresponding author: valerija.bukvic@podravka.hr

Summary

Vitamins are biologically active components that help maintain health and regulates growth and development of the organism. Since the food enriched with vitamins is of great importance for the laboratories of food business operators, their detection and quantification is important. The aim of the research is to optimize the method for determination of added vitamin B group in breakfast cereal reference material.

Principle of the method is the acid hydrolysis vitamin extraction, and the content was determined using high performance liquid chromatography (HPLC) with a reverse phase column and a fluorescent detector. For vitamin B₁ is further conducted the oxidation into thiochrome with isobutanol, and for niacin post-column derivatization with UV irradiation in the presence of copper (II) ions and hydrogen peroxide. Optimization included variation of autoclaving time (5, 10, 15, 30 minutes), sample weight reduction and solvent volume reduction. This paper developed a simple and rapid method for determination of vitamin B group in breakfast cereal samples. The optimized method was validated with respect to linearity, precision and accuracy, and external evaluation of test results quality was proven by participation in Proficiency tests. Conducted method for determination of vitamin B group had positive effects on the efficiency of the laboratory.

Keywords: vitamin B group, optimized method, proficiency tests

Primjena antiretrovirusne terapije u liječenju infekcija uzrokovanih virusom HIV-om

Jelena Klenkar*

*Sveučilište J. J. Strossmayera u Osijeku, Prehrambeno-tehnološki fakultet Osijek,
Franje Kuhača 20, 31 000 Osijek, Hrvatska
Dopisni autor: jelena.klenkar@gmail.com

Sažetak

Poznato je već nekoliko desetljeća da je uzročnik SIDE tj. sindroma stečene imunoneдостatnosti (engl. AIDS-acquired immunodeficiency syndrom) virus humane imunoneдостatnosti (engl. HIV-Human immunodeficiency virus). Od tada pa do danas razvijeno je više lijekova za HIV infekcije nego za sve ostale virusne infekcije zajedno. Anti -HIV lijekovi ubrajaju se u različite kategorije ovisno o fazi životnog ciklusa HIV-a koju inhibiraju; nukleozidni inhibitori reverzne transkriptaze (NRTI: zidovudin, didanozin, zalcitabin, stavudin, lamivudin, abacavir i emtricitabin); nukleotidni inhibitori reverzne transkriptaze (NtRTI: tenofovir), nenukleozidni inhibitori reverzne transkriptaze (NNRTI: nevirapin, delavirdin, efavirenz i etravirin), inhibitori proteaze (PI: sakvinavir, ritonavir, indinavir, nelfinavir, amprenavir, lopinavir, atazanavir, fosamprenavir, tiprinavir i darunavir), inhibitori ulaska u stanicu domaćina (fuzijski inhibitori (FI: enfuvirtid) i koreceptorski inhibitori (CRI: maraviroc)) i inhibitori integraze (INI: raltegravir). Kako bi se postigli što bolji rezultati, poboljšala tolerantnost na lijek i smanjila pojava rezistentnosti na lijek, danas se koristi visokoučinkovita antiretrovirusna terapija tzv. HAART terapija, koja koristi kombinaciju 2, 3 ili više lijekova koji inhibiraju različite faze u replikaciji virusa HIV-a.

Ključne riječi: virus HIV-a, anti-HIV lijekovi, HAART terapija

Uvod

Virus HIV-a (engl. HIV - Human immunodeficiency virus) prvi put su izolirali 1983. godine istraživači s Pasteurovog instituta u Parizu iz bioptata limfnog čvora bolesnika i nazvali ga virus udružen s limfadenopatijom (LAV, fr. *Lymphadénopathie associé virus*). 1984. god. identičan je virus dokazan i u SAD-u te nazvan ljudskim virusom leukemije T-limfocita (HTLV, engl. *Human T-cell leukemia virus*). Od 1986. koristi se isključivo naziv virus ljudske imunodeficijencije (HIV, engl. *Human immunodeficiency virus*) (Planinić, 2014).

AIDS i infekcije uzrokovane HIV-om predstavljaju globalni zdravstveni problem; kompleksnu znanstvenu "puzzlu" za otkrivanje novih lijekova i cjepiva. Prvi puta zabilježena 1981. na malom broju pacijenata, AIDS je danas poprimila razmjere epidemije sa više od 38 milijuna inficiranih ljudi diljem svijeta, uključujući oko 1 milijun u SAD-u, oko 580 000 u zapadnoj Europi i više od 25 milijuna ljudi u subsaharskom području Afrike (Pommier i sur., 2005).

Životni ciklus virusa humane imunodeficijencije (HIV)

Virus HIV-a se najčešće prenosi parenteralnim ili spolnim putem. Prvi korak uključuje vezanje (adsorpcija) HIV-a za ciljne stanice u limfnim čvorovima, gdje se replicira i uzrokuje kronične infekcije (Palmisano i Vella, 2011). Infekcija HIV-om započinje vezanjem virusnog glikoproteina gp120 za molekulu CD4 na membrani ciljane stanice. Molekula CD4 je eksprimirana na membrani T-limfocita, monocita, dendritičkih stanica i stanica mikroglije i primarni je stanični receptor za HIV (Planinić, 2014). Vezanje na CD4 proteine dovodi do konformacijskih promjena u glikoproteinu gp 120, neki od tih promjena formiraju aktivno mjesto za specifične kemokin receptore. Ti kemokin receptori (najčešći su CCR5 i CXCR4), su sekundarni receptori potrebni za fuziju virusa HIV-a u stanicu. V3-petlja u glikoproteinu gp 120 određuje specifičnost kemokin receptora (Kwong i sur., 1998). Glikoprotein gp 120 ima 11 definiranih petlji, pri čemu je pet varijabilnih (V1-V5) (De Clercq, 2002). Uporaba kemokinskih koreceptora CCR5 i/ili CXCR4 za ulazak HIV-a u stanicu naziva se koreceptorskim tropizmom virusa (Planinić, 2014). Sojevi HIV-a koji koriste koreceptor CCR5 nazivaju se R5-virusima ili M-trofični virusi, a sojevi virusa koji koriste CXCR4 nazivaju se X4- virusi ili T-trofični virusi. CXCR4 i CCR5 prirodni su receptori za CXC kemokine (SDF1 -engl. stromal cell-derived factor 1) i C-C kemokine (RANTES -engl. regulated upon activation, normal T-cell expressed and secreted i MIP1 -engl. macrophage inflammatory protein 1) (De Clercq, 2002). Općenito, R5-virusi inficiraju makrofage i T- stanice, a karakterizira ih manje agresivan rast in vitro. X4-virusi inficiraju samo T- stanice, a njihov rast in vitro karakterizira visoki virusni titar i prisutnost tzv. sincicijskih stanica, koje nastaju spajanjem

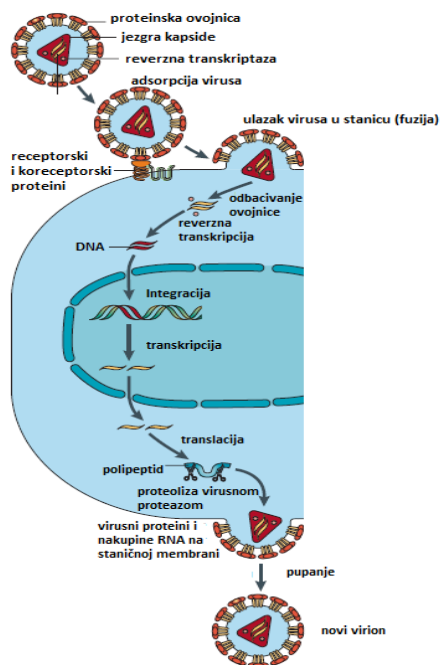

većeg broja inficiranih stanica, te ih možemo vidjeti svjetlosnim mikroskopom (Shehu-Xhilaga i Oelrichs, 2009). Nakon što se gp 120 HIV-a veže za molekulu CD4 i koreceptor, konformacijska promjena u gp 41 uzrokuje umetanje N-terminalnog hidrofobnog dijela peptida u membranu ciljane stanice. Ovo umetanje uzrokuje fuziju membrane i ulazak virusnih čestica u citoplazmu. Proces fuzije kritički ovisi o interakciji između N- i C-terminalnog dijela gp 41 u izvanstaničnom prostoru (Shehu-Xhilaga i Oelrichs, 2009). Nakon fuzije, prvo dolazi do reverzne transkripcije RNA u u jednolančanu DNA, zatim u dvolančanu DNA. Ova dva koraka katalizirana su pomoću virusne reverzne transkriptaze. Dvolančana DNA kako bi mogla biti aktivno transportirana u jezgru, formira kompleks sa proteinima virusa (uključujući matriks, integrazu i Vpr) i proteinima stanice domaćina (Shehu-Xhilaga i Oelrichs, 2009).

Slika 1. Životni ciklus virusa HIV-a
Fig. 1. The HIV life cycle (De Clercq, 2002)

Kemijska analiza i sinteza / Chemical Analysis and Synthesis

Zatim je integrirana pomoću virusne integraze u genom stanice domaćina ili formira stabilne DNA krugove. Integrirani oblik HIV poznat je kao provirus. Provirusna DNA se replicira zajedno sa normalnim dijelom staničnog genoma i može ostati u integriranom obliku duži period (Shehu-Xhilaga i Oelrichs, 2009).

Antiretrovirusna terapija

Primjena antiretrovirusne terapije započela je 1984. godine otkrićem suramina, lijeka koji se koristio u terapiji tripanosomijaze i onkocerkoze. Suramin, iako se pokazao djelotvoran u inhibiciji reverzne transkriptaze velikog broja retrovirusa, zbog svoje pretoksičnosti više se ne koristi u antiretrovirusnoj terapiji. Razvijeni su novi manje toksični i djelotvorniji inhibitori reverzne transkriptaze, analozi 2',3'-dideoksinukleozida (ddN) (De Clercq, 2005). Prvi ddN analozi, češći naziv nukleozidni inhibitori reverzne transkriptaze (NRTI) bili su 3'-azido-3'-deoksitimin (AZT), 2',3'-dideoksiinozin (ddI), 2',3'-didehidrotimidine (d4T), kasnije spojen u (-) 3'-tia- 2', 3'-dideoksicitidine (3TC), abacavir (ABC) i emtricitabin ((-)FTC). Od ddN analoga, AZT (zidovudin) je bio prvi lijek odobren za kliničku upotrebu u terapiju AIDS-a, te unatoč toksičnosti (toksično djeluje na koštano srž) i dalje se danas koristi u kombinaciji sa ostalim HIV lijekovima (De Clercq, 2005). U samim počecima traženja anti HIV lijeka, bilo je teško predvidjeti da će do 2008. godine 25 godina nakon što je virus HIV-a otkriven biti dostupno 25 anti HIV lijekova odobrenih za kliničku upotrebu. Ti lijekovi ubrajaju se u različite kategorije ovisno o fazi životnog ciklusa HIV-a koju inhibiraju (De Clercq, 2009).

Inhibitori fuzije

Virusi sa ovojnicom, u pravilu ulaze u stanicu procesom fuzije virusne ovojnice i membrane stanične plazme. Ovaj proces sličan je za sve viruse sa ovojnicom, kao što su retrovirusi, paramiksovirusi i herpesvirusi. Međutim, kod HIV-a prije fuzije dolazi do interakcije glikoproteina gp 120 sa koreceptorima na stanici domaćina- kemokin pokretački receptor 4 (CXCR4) ili kemokin pokretački receptor 5 (CCR5) (De Clercq, 2002).

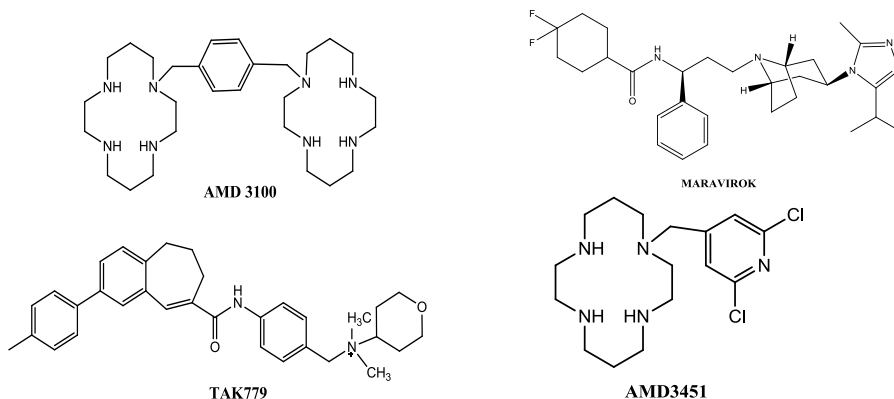

Slika 2. Koreceptorski inhibitori
Fig. 2. Coreceptor inhibitors (De Clercq, 2002)

Antagonisti CXCR4 i CCR5 blokiraju odgovarajući koreceptor, te sprječavaju ulazak HIV-a u stanicu (De Clercq, 2002). Najistaknutiji među antagonistima CXCR4 je biciklam AMD 3100, dok TAK779 ima najbolje djelovanje kao antagonist CCR5 (De Clercq, 2002). AMD-3100 može spriječiti samo replikaciju X4- virusa ili sojeve dvojnog tropizma X4/R5 virusa HIV-a (De Clercq, 2005). U 2007. godini je odobren je za kliničku upotrebu jedini koreceptorski inhibitor maravirok, koji je antagonist CCR5 (De Clercq, 2009). Kako bi se osigurala maksimalna pokrivenost oba soja (X4 i R5), trebaju biti razvijeni antagonisti koji djeluju protiv oba soja virusa HIV-a ili kombinirati antagoniste CCR5 i antagoniste CXCR4 (De Clercq, 2002).

AMD-3451, analog N-piridinimetila pokazao je antivirusnu aktivnost na R5, R5/X4 i X4 sojevima HIV-a. Ovaj antagonist inhibira signalizaciju unutarstaničnog Ca^{2+} koja je inducirana ligandom CXCL12 kemokin receptora CXCR4, te ligandima CCL5, CCL3 i CCL4 kemokin receptora CCR5, te se može smatrati dvojnim antagonistom (De Clercq, 2005).

Fuzijski inhibitori vežu se za gp 41, te sprječavaju konformacijsku promjenu gp 41 pri čemu blokiraju infekciju (Matthews i sur., 2004). Nakon adsorpcije virusa na CD4 receptore, konformacijska promjena u gp 120 omogućava vezanje na koreceptore CCR5 i CXCR4, dok konformacijska promjena u gp41 omogućava umetanje hidrofobnih dijelova N-terminalnog kraja u membranu stanice domaćina. HR2 područje gp 41 se zatim savija i povezuje sa HR1 područjem gp41. Ovaj proces (engl. gp 41 zipping) dovodi do fuzije virusne i stanične membrane (Matthews i sur., 2004).

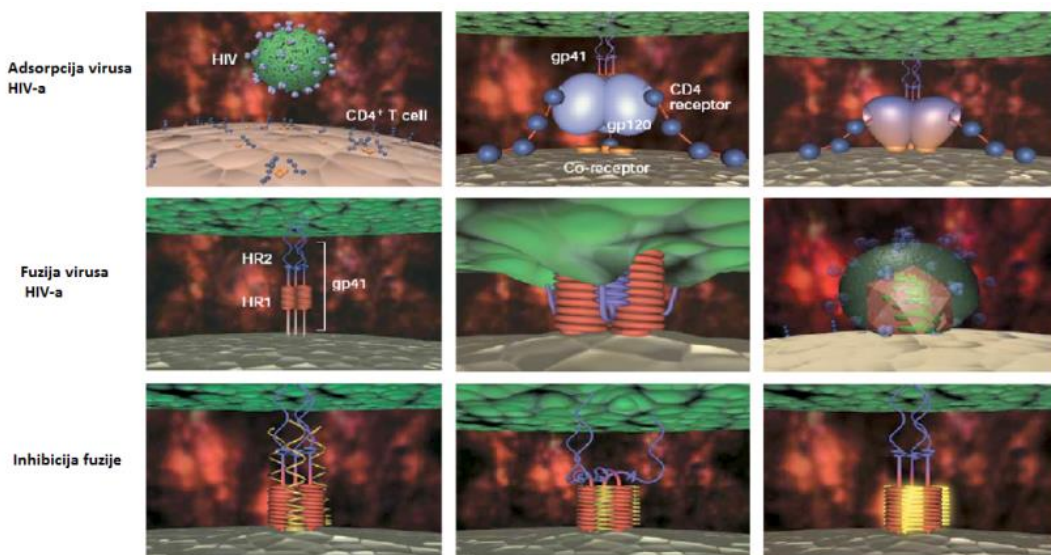

Slika 3. Mehanizam djelovanja fuzijskog inhibitora enfuvirtida

Fig. 3. Mechanism of action of fusion inhibitor enfuvirtide (Matthews i sur., 2004)

Kemijska analiza i sinteza / *Chemical Analysis and Synthesis*

Prvi sintetički peptid DP-107 koji se koristio kao fuzijski inhibitor sadržavao je 38 amino kiselina koje odgovaraju aminokiselinama N terminalnog područja gp 41. Substitucijom amino kiselina i kemijskom modifikacijom u DP-107 došlo je do destabilizacije sekundarne strukture i značajnog smanjenja njegove antivirusne aktivnosti (Matthews i sur., 2004). Peptid koji sadrži 36 amino kiselina DP-178, kasnije nazvan enfuvirtid (Fuzeon, prijašnji naziv T-20) oponaša C terminalni kraj gp 41 i 100 puta je djelotvorniji od DP-107 (Matthews i sur., 2004). Enfuvirtid se za razliku od ostalih antiretrovirusnih lijekova, ne primjenjuje u oralnom obliku, već u obliku injekcija supkutano (pod kožu) (Mohanty i Dixit, 2008). Enfuvirtide je trenutno jedini dostupan fuzijski inhibitor za liječenje infekcija HIV-om (De Clercq, 2009).

Inhibitori reverzne transkriptaze

Reverzna transkriptaza (RT) je esencijalan enzim u replikativnom ciklusu retrovirusa, kao što je HIV. Upravo zbog toga što je esencijalna samo za replikaciju HIV-a, tj. nije potrebna za metabolizam stanice domaćina, zanimljiva je meta djelovanja antiretrovirusnih lijekova. Reverzna transkriptaza HIV-a je meta djelovanja tri vrste inhibitora: nukleozidni inhibitori reverzne transkriptaze (NRTI), nukleotidni inhibitori reverzne transkriptaze (NtRTI) i nenukleozidni inhibitori reverzne transkriptaze (NNRTI) (De Clercq, 2009).

Nukleozidni inhibitori reverzne transkriptaze (NRTI)

NRTI pokazuju svoje anti-HIV djelovanje, tako što inhibiraju aktivnost HIV reverzne transkriptaze. Kako bi djelovali, moraju biti fosforilirani pomoću kinaza stanice domaćina do trifosfata. Nakon fosforilacije, pomoću DNA polimeraze ugrađuju se u rastući DNA lanac. Zbog nedostatka OH skupine u položaju 3', onemogućavaju daljnju ugradnju nukleotida, te zaustavljaju rast DNA lanca (Mehellou, De Clercq, 2009). Trenutno je odobreno (2008. god.) sedam NRTI za liječenje HIV infekcija: zidovudin (AZT), didanozin (ddI), zalcitabin (ddC), stavudin (d4T), lamivudin (3TC), abacavir (ABC) i emtricitabin ((-)FTC) (De Clercq, 2009). Svi ovi dideoksinukleozidni analozi (ddN) djeluju slično kao AZT. Moraju biti fosforilirani unutar stanice domaćina pomoću tri stanične kinaze; nukleozidne kinaze (NDP), nukleozidne 5'-monofosfat kinaze i nukleozid 5'-difosfat kinaze kako bi nastao 5'-trifosfat derivat, koji tijekom reverzne transkripcije (RNA→DNA) zaustavlja rast DNA lanca (De Clercq, 2002).

Nukleotidni inhibitori reverzne transkriptaze (NtRTI)

Nukleotidni inhibitori reverzne transkriptaze (NtRTI) razlikuju se od nukleozidnih inhibitora reverzne transkriptaze (NRTI) u tome što NtRTI trebaju samo dva stupnja fosforilacije kako bi postali aktivni (De Clercq E., 2009). Što je najvažnije, sadrže fosfonatnu grupu koju esteraza ne može odcjepiti, te jednom kada se ugrade u 3' terminalni kraj lanca DNA, teško se otcjepe za razliku od regularnih nukleotida (npr. ddAMP, ddCMP) (De Clercq, 2009). Prototip NtRTI tenofovir ((R)9-(2-fosfometoksi propil) adenin) prvi puta je opisan 1993. godine (De Clercq, 2009). Tenofovir (PMPA) je analog nukleotida koji pripada acikličkim nukleozidnim fosfonatima. Tenofovir se unutar stanice metabolizira u aktivni metabolit, tenofovir difosfat, koji je kompetitivni inhibitor HIV-1 reverzne transkriptaze, te zaustavlja rast DNA lanca (Barditch-Cruovo i sur., 2001). Međutim, tenofovir je pokazao lošu bioraspodjeljivost, stoga je razvijen njegov prolijek tenofovir dizoproskil fumarat (Barditch-Cruovo i sur., 2001). Tenofovir dizoproskil fumarat (TDF) je

najčešće prepisani lijek za liječenje HIV infekcija. Od 2008. godine je odobren i za liječenje kroničnih infekcija uzrokovanih hepatitisom B (De Clercq, 2009).

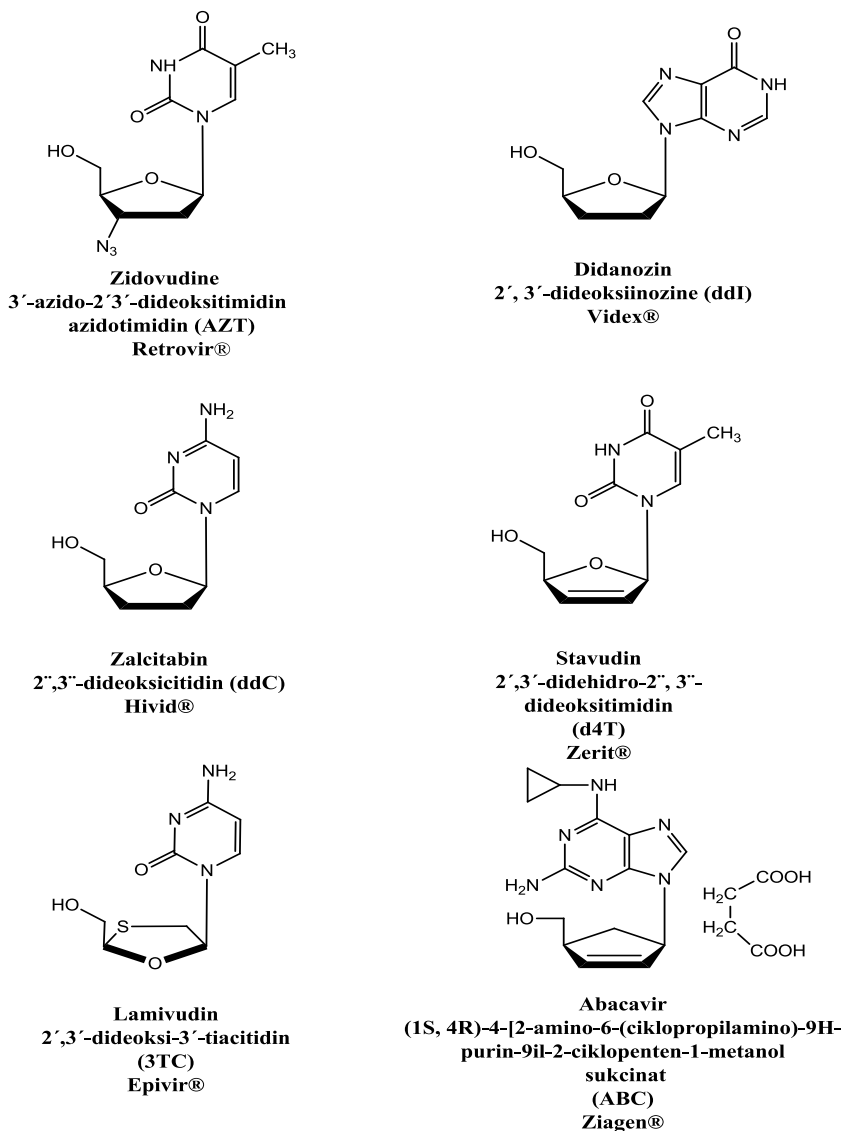

Slika 4. Strukture nukleozidnih inhibitora reverzne transkriptaze (NRTI)
Fig. 4. Structure of nucleoside reverse transcriptase inhibitors (De Clercq, 2009)

Kemijska analiza i sinteza / Chemical Analysis and Synthesis

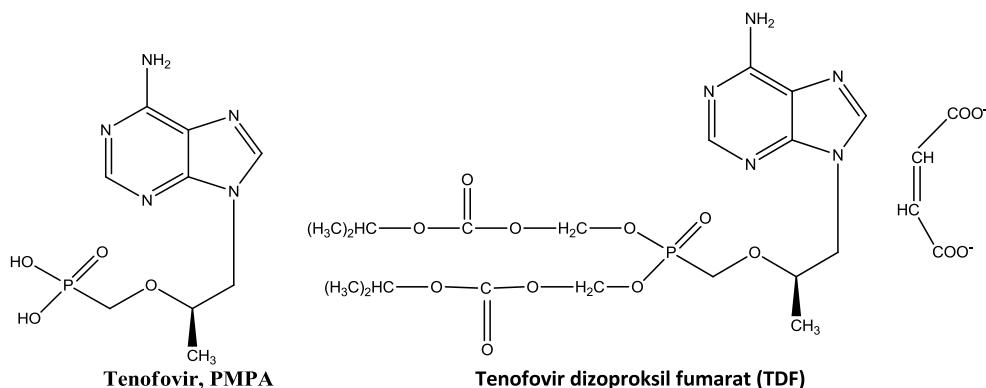

Slika 5. Struktura tenofovira i njegovog prolijeka tenofovir dizoproksil fumarata (TDF)
Fig. 5. Structure of tenofovir and his prodrug tenofovir disoproxil fumarate (De Clercq, 2009)

Nenukleozidni inhibitori reverzne transkriptaze (NNRTI)

NNRTI su nekompetitivni inhibitori HIV- reverzne transkriptaze, tj. vežu se na alosteričko mjesto u blizini (~15 Å) aktivnog mjesta reverzne transkriptaze (Mehellou, De Clercq, 2009). Alosteričko mjesto ne postoji u reverznoj transkriptazi koja ne sadrži ligand, te postoji jedino u reverznoj transkriptazi HIV-1. Stoga samo reverzna transkriptaza HIV-1 posjeduje vezna mjesta za NNRTI. Vežanje NNRTI za alosteričko mjesto uključuje interakcije sa aromatskim amino kiselinama Y181, Y188, W229 i Y318, elektrostatske interakcije sa K101, K103 i E138, van der Waalsove interakcije sa L100, V106, Y181, G190, W229, L234 i Y318 i međusobno povezivanje vodikovim vezama sa peptidnom vezom glavnim lanca (De Clercq, 2002).

Primjena NNRTI započela je otkrićem 1-[(2-hidroksietoksi)metil]-6-(fenilsulfanil) timin (HEPT) i 4,5,6,7-tetrahidroimidazo [4,5,1-jk] [1,4]benzodiazepin-2(1H)-on i -tione (TIBO), kao specifičnih inhibitora HIV-1 (ne djeluju protiv HIV-2 i ostalih retrovirusa) (De Clercq, 2004). HEPT je prvo bio ispitan kao potencijalno djelotvoran protiv herpes simplex virusa (HSV). Ova tvrdnja je bila inspirirana činjenicom da HEPT isto kao i aciklovir koji je djelotvoran protiv HSV sadrži (2-hidroksietoksi)metil lanac. Tijekom toga vremena već se znalo da 1-[(2-hidroksietoksi)metil] pirimidin derivati, te također i derivati (E)-5-(2-bromovinil) nisu pokazali djelovanje protiv HSV. Kao što nije ni HEPT (TS-II-25). HEPT (TS-II-25) je prvi nenukleozidni inhibitor reverzne transkriptaze (NNRTI) djelotvoran protiv HIV tipa 1 (De Clercq, 2013).

Dva mjeseca nakon HEPT derivata, opisani su i TIBO derivati kao specifični inhibitori HIV-1 reverzne transkriptaze. Od originalnih TIBO derivata, jedino je TIBO R86183 odobren kao klinički lijek pod nazivom tivirapine (De Clercq, 2013). Rilpivirin (TMC278) je najnoviji član nenukleozidnih inhibitora reverzne transkriptaze koji inhibira HIV-1 reverznu transkriptazu. Kao i ostali TIBO derivati, rilpivirine veže se na aktivno mjesto kao i ostali nenukleozidni inhibitori reverzne transkriptaze NNRTI, dok se cijanovinilna grupa rilpivirina veže sa aminokiselinom W229 reverzne transkriptaze. Dvodimenzionalni infracrveni spektar kompleksa rilpivirina sa HIV-1 reverznom transkriptazom pokazao je dovoljnu fleksibilnost kompleksa, što objašnjava potencijalno djelovanje rilpivirina protiv rezistentnih mutanata (De Clercq, 2013).

Nevirapine je prvi NNRTI kojeg je odobrila FDA 1996.god, zatim delavirdine 1997. god i efavirenz 1998. god. Novija generacija NNRTI, etravirin odobrena je 2007. god. za liječenje pacijenata sa rezistencijom na NNRTI (Schrijvers i sur., 2011).

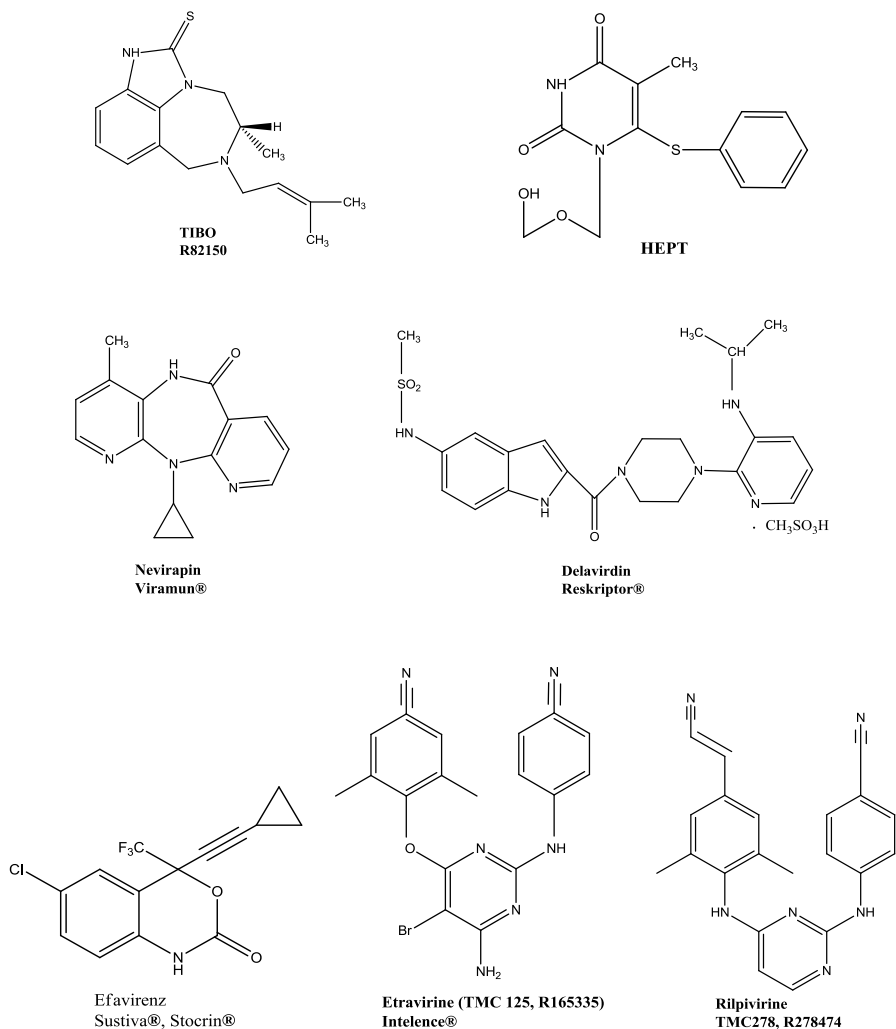

Slika 6. Strukture nenukleozidnih inhibitora reverzne transkriptaze (NNRTI)
Fig. 6. Structure of non-nucleoside reverse transcriptase inhibitors (De Clercq, 2009)

Kemijska analiza i sinteza / Chemical Analysis and Synthesis

Inhibitori integraze

Oko 40 – 100 molekula integraze se nalazi upakirano u svakom pojedinom virusu HIV-a. Primarna uloga integraze je kataliza ugradnje (integracija) virusne cDNA u genom inficirane stanice, iako integraze mogu djelovati i kao kofaktori u reverznoj transkripciji. Proces integracije je esencijalan za virusnu replikaciju, jer za transkripciju virusnog genoma i sintezu proteina virusa potrebno je da virusna cDNA bude integrirana u kromosom (Pommier i sur., 2005). Nakon reverzne transkripcije, integraza otcjepljuje 3'-kraj na virusnoj cDNA u citoplazmi. Ovaj korak u procesu integracije se naziva 3'-cijepanje (engl. 3'-processing) i uključuje endonukleolitičko cijepanje nukleotida sa 3'-kraja lanca virusne cDNA. Nakon 3'-cijepanje, integraza ostaje povezana sa virusnom cDNA u multimerni kompleks u kojem su oba kraja virusne cDNA povezana. Ovaj kompleks tzv. preintegracijski kompleks (PIC) sadrži virusne i stanične proteine. Virusni proteini (reverzne transkriptaze (RT), matriksa, nukleokapside) omogućavaju transport PIC-a kroz membranu stanične jezgre (Pommier i sur., 2005).

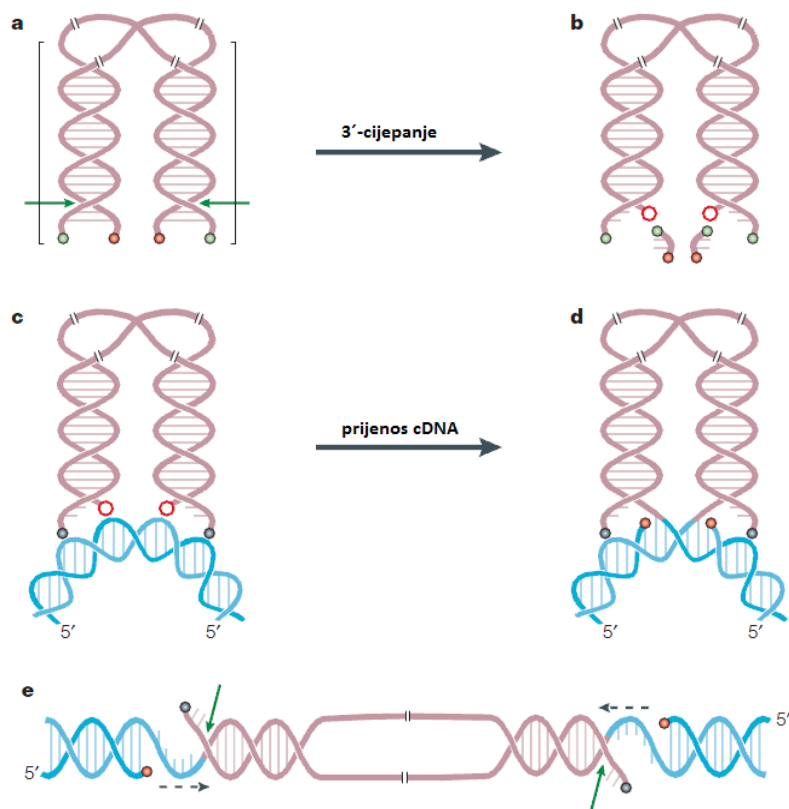

Slika 7. Shematski prikaz procesa integracije cDNA u genom stanice domaćina
Fig. 7. A schematic representation of the process of integration c DNA into the genome of the host cell (Pommier i sur., 2005)

Za razliku od ostalih lenta virusa, kao što su onkoretrovirusi Moloney-ev mišji virus i Rous sarkoma virus, preintegracijski kompleks (PIC) HIV-1 može proći kroz pore membrane jezgre, bez njezina prethodnog cijepanja (Pommier i sur., 2005). Nakon šta dospije u jezgru, integraza katalizira umetanje krajeva virusne cDNA u kromosom domaćina. Povezuje se 3'-OH kraj virusne DNA sa 5'-DNA fosfatom kromosoma domaćina. Integraza može također i katalizirati reverzibilnu reakciju tj. dezintegraciju. Potpuno integrirani virus HIV-a naziva se provirus (Pommier i sur., 2005). Iako je se mnogo godina radilo na traženju lijeka koji inhibira djelovanje integraze, tek je u 2007. godini raltegravir, kao prvi integrazni inhibitor odobren za kliničku upotrebu (De Clercq, 2009). Raltegravir, poznat i kao MK-0518 inhibira prijenos cDNA u procesu integracije HIV-1. Djelotvoran je protiv rezistentnog HIV-1 i oba soja HIV-1, CCR5 i CXCR4 trofičnih virusa *in vitro* (Grinsztejn, 2007).

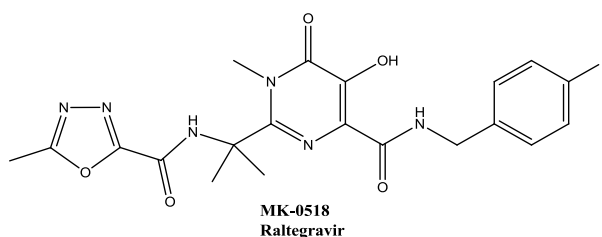

Slika 8. Struktura Raltegravira
Fig. 8. Structure of Raltegravir (De Clercq, 2009)

Inhibitori proteaze (PI)

Protease virusa su ključne u životnom ciklusu mnogih virusa, uključujući retroviruse kao što je HIV, herpes virusi, picorna virusi (npr. rinovirus) i flavivirusi kao što je HCV (humani citomegalovirus). Stoga su virusne proteaze pogodne mete antivirusnih agenata (De Clercq, 2002). Proteaze cijepaju novo eksprimirane prekursore poliproteina u manje zrele virusne proteine, koji se nazivaju funkcionalni (imaju enzimsko djelovanje) ili strukturni (ako su dio strukture viriona) (De Clercq, 2002). Npr., u procesu replikacije HIV-a, HIV proteaze cijepaju glikozoaminoglikan (gag) i prekursorske proteine gag polimeraze (gag-pol) u strukturne (p17, p24, p9 i p7) i funkcionalne proteine (protease, reverzne transkriptaze/RNaze H i integraze) (De Clercq, 2002).

Inhibitori HIV proteaze su iskrojani prema peptidnoj vezi u prekursorskim proteinima gag i gag-pol koje cijepaju proteaze. Najčešće se modeliraju prema aktivnom mjestu enzima, koje se nalazi na razmeđu dviju homodimernih podjedinica i u koje strše ogranci asparaginske kiseline (Mintas, Raić-Malić, 2009). Trenutno je prisutno deset inhibitora proteaze koji su odobreni za kliničku upotrebu u liječenju HIV infekcija. Osim tipranavira, svi PI su bazirani na peptidomimetičkom principu, sadrže središnji hidroksietilenski most koji imitira peptidnu vezu koju HIV proteaza ne može cijepati.

Deset PI trenutno dostupnih za liječenje HIV infekcija su: sakvinavir, ritonavir, indinavir, nelfinavir, amprenavir, lopinavir, atazanavir, fosamprenavir, tipranavir i darunavir (De Clercq, 2009).

Inhibitori HIV proteaze korisni su kemoterapeutici koji se koriste u kombinaciji sa nukleozidnim i nenukleozidnim inhibitorima reverzne transkriptaze u HAART terapiji (visoko učinkovita

Kemijska analiza i sinteza / *Chemical Analysis and Synthesis*

antiretrovirusna terapija) za liječenje HIV infekcija. Međutim, u kliničkoj primjeni uočena su njihova štetna popratna djelovanja, loša podnošljivost za pacijente, međudjelovanje s drugim lijekovima, te pri njihovoj dugotrajnoj primjeni uočeno da ti lijekovi izazivaju lipodistrofiju, kardiovaskularne poremećaje i bolesti poremećaja metabolizma (poput dijabetesa) (Mintas, Raić-Malić, 2009). To je potaknulo istraživanja za novim, nepeptidnim inhibitorima HIV proteaze koji umjesto peptidomimetičkog hidroksietilenskog središnjeg mosta sadrži cikličku ureju, 4-hidroksikumarin ili 4-hidroksi-5,6-dihidro-2-piron (De Clercq, 2002).

Tipranavir je prvi nepeptidni inhibitor HIV-1 proteaze djelotvoran protiv sojeva HIV-1 koji su rezistentni na ostale inhibitore proteaze (Flexner i sur., 2005).

Kombinirana kemoterapija: Visoko učinkovita antiretrovirusna terapija (HAART)

Od 1996 godine, važnost primjene kombinatorne kemoterapije za liječenje HIV infekcija je postala široko prihvaćena. Kombinatorska kemoterapija bila je česta praksa za liječenje tuberkuloze (kombinacija tri tuberkulostatika). Također je uvedena i za liječenje AIDS-a, te je dobila svoj vlastiti akronim, HAART tj. visoko učinkovita antiretrovirusna terapija (De Clercq, 2009).

Uvođenjem HAART terapije značajno je smanjena smrtnost pacijenata sa HIV-om i zasigurno je monoterapija postala prošlost. Danas se u terapiji HIV-a koristi kombinacija dva ili tri (ili više) lijekova koji inhibiraju različite faze u životnom ciklusu HIV-a (Mehellou, De Clercq, 2009). Prva upotreba HAART terapije kod pacijenata uključivala je uzimanje puno tableta dnevno, stoga su farmaceutske tvrtke naporno radile kako bi te lijekove spojile u samo jednu tabletu. Prvi takav lijek bio je Kombivir, koji se sastojao od dva nukleozidna inhibitora reverzne transkriptaze (NRTI), zidovudina i lamivudina.

Tri godine kasnije uveden je Trizivir, koji je se sastoji od tri nukleozidna inhibitora reverzne transkriptaze (NRTI), te se uzima kao 1 tableta dva puta dnevno (Mehellou, De Clercq, 2009). U 2004. godini odobrene su još dvije kombinacije lijekova za liječenje HIV infekcija, Epzicom i Truvada. Epzicom se sastoji od kombinacije dva nukleozidna inhibitora reverzne transkriptaze, te u Europi dolazi pod nazivom Kivexa. Truvada je prvi kombinatorski lijek koji sadrži nukleotidne inhibitore reverzne transkriptaze. U 2006. godini razvijen je i peti kombinatorski lijek, Atripla, koji se sastoji od kombinatorskog lijeka truvade i efavirenza (Mehellou, De Clercq, 2009). 27. kolovoza 2012. godine odobren je od FDA je prvi kombinatorski lijek koji sadrži četiri lijeka (engl. quad pills) pod nazivom Stribild. Stribild se sastoji od četiri aktivne komponente: TDF(tenofovir),(-)FTC (emtricitabin), kobicistat (engl. pharmacoenhancer, strukturno sličan ritonaviru, ali ne pokazuje anti HIV aktivnost) i elvitegravir (inhibitor integraze). Sljedeća kombinacija koja se razmatra je TDF, (-) FTC, kobicistat i atazanavir (inhibitor proteaze) (De Clercq, 2013). Dok je u teoriji broj mogućih kombinacija anti HIV lijekova rapidno raste, broj tableta koje oboljeli moraju uzimati se smanjio sa 20 tableta dnevno u 1996. godini na samo jednu tabletu sa kombinatorskim lijekom u 2006. godini (De Clercq, 2009). HAART terapija je poboljšala toleranciju na lijek, smanjila razvoj rezistencije na lijek, te poboljšala kvalitetu života HIV pozitivnih pacijenata (Mehellou, De Clercq, 2009).

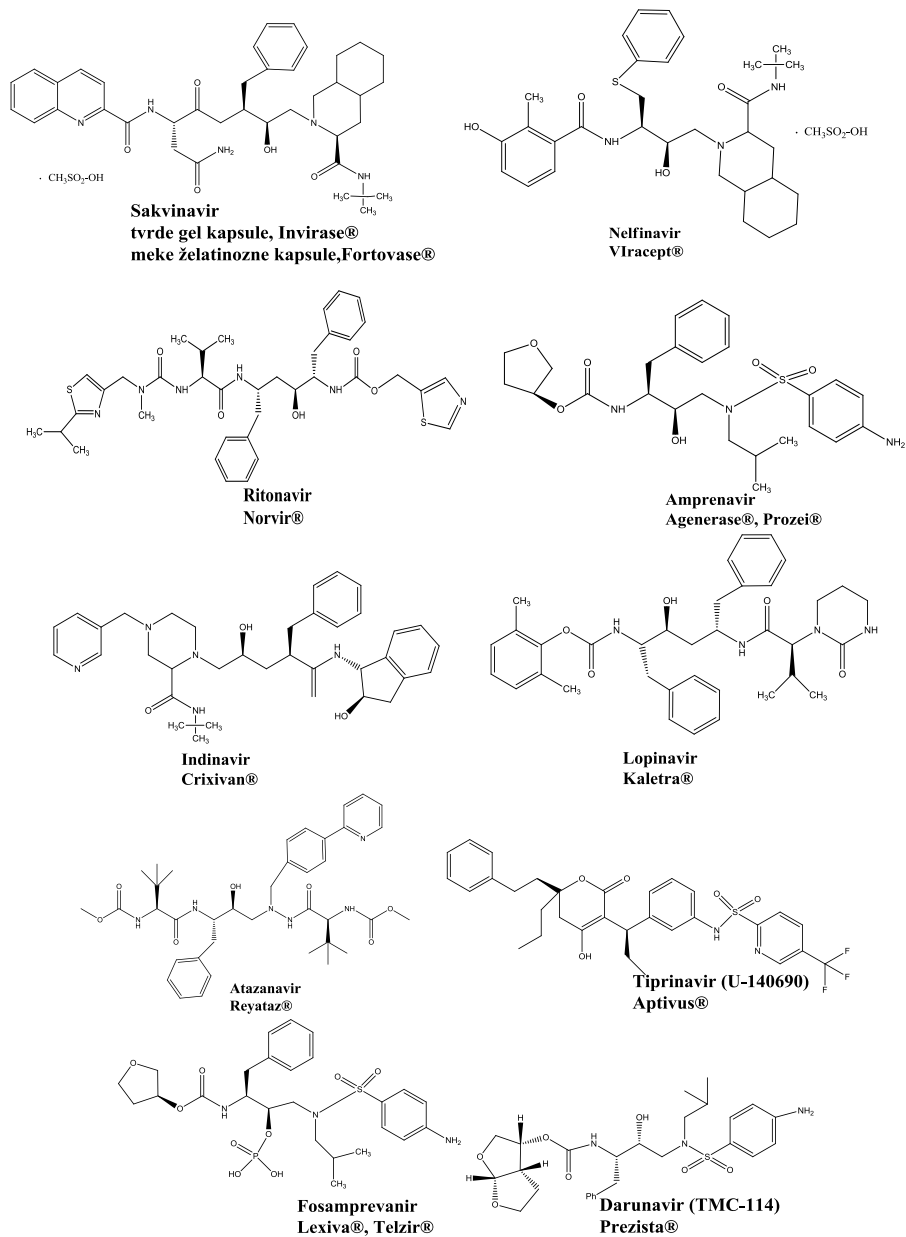

Slika 9. Strukture Inhibitora HIV proteaze
Fig. 9. Structure of HIV protease inhibitors (De Clercq, 2009)

Kemijska analiza i sinteza / Chemical Analysis and Synthesis

Zaključci

U odsutnosti djelotvornog cjepiva za HIV infekcije, iskorijenjivanje HIV-a je postao glavni globalni problem. Iako se većina stanica inficiranih HIV-om uništi, mali dio stanica vraća se u "latentnu" fazu i preživi, te se DNA HIV-a trajno integrira u genom domaćina. Pošto su ove stanice jedne od najduže živućih stanica u tijelu, infekcije HIV-om mogu perzistirati u latentnom obliku koji je nedostupan imunološkom sustavu i trenutnoj antiretrovirusnoj terapiji (Palmisano i Vella, 2011). Nema sumnje, da je od otkrića virusa humane imunodeficijencije (HIV), napredak u razvoju djelotvornog lijeka u anti HIV terapiji uspješniji od otkrića lijekova za ostale virusne infekcije. Ovaj napredak stvorio je arsenal anti HIV lijekova, koji inhibiraju različite faze u životnom ciklusu HIV-a. To je dovelo i do upotrebe tih lijekova u kombinatornoj terapiji HIV infekcija (HAART terapija) (Mehellou, De Clercq, 2009). Iako su se ovi lijekovi pokazali djelotvornim, problemi poput toksičnosti i razvoja rezistentnosti, ograničavaju njihovu upotrebu, te je potreban razvoj novih anti HIV lijekova (Mehellou, De Clercq, 2009). Razvoj novih anti -HIV lijekova sa novim mehanizmom djelovanja treba biti prioritet za sve koji se bave razvojem lijekova za liječenje HIV infekcija. Brojne nove mete anti HIV lijekova su identificirane. Neke od tih meta su regulatorni i /ili pomoćni proteini kao što su Tat, Rev i Nef. Ovi proteini su esencijalni za funkcioniranje HIV, te njihovom inhibicijom možemo se uspješno boriti protiv HIV-a (Mehellou, De Clercq, 2009). S obzirom da lijek još nije dostupan, potrebno je doživotno liječenje pacijenata i također postoji rizik od odgođenog toksičnog djelovanja lijeka (Palmisano i Vella, 2011).

Literatura

- Barditch-Cruovo, P., Deeks, S. G., Collier, A., Safrin, S., Coakley, D. F., Miller, M., Kearney B. P., Coleman, R. L., Lamy, P. D., Kahn, J. O., McGowan, I., Lietman, P. S. (2001): Phase I/II Trial of the Pharmacokinetics, Safety, and Antiretroviral Activity of Tenofovir Disoproxil Fumarate in Human Immunodeficiency Virus-Infected Adults, *Antimicrob. Agent, Chemother.*, 45 (10), 2733-2739.
- De Clercq, E. (2009): Anti-HIV drugs: 25 compounds approved within 25 years after the discovery of HIV, *Int. J. Antimicrob. Ag.*, 33 (4), 307–320.
- De Clercq E. (2005): Emerging anti HIV drugs, *Expert opin. Emerging drugs*, 10 (2), 241-274.
- De Clercq, E. (2004): Non-Nucleoside Reverse Transcriptase Inhibitors (NNRTIs): Past, Present, and Future, *Chem. Biodivers.*, 1 (1), 44-64.
- De Clercq, E. (2002): Strategies in design of antiviral drugs, *Nat.rev.drug.discov.*, 1 (1), 13-25.
- Flexner, C., Bate, G., Kirkpatrick, P. (2005): Tipranavir, *Nat.rev.drug.discov.*, 4 (12), 955-956.
- Grinsztejn, B., Nguyen, B. Y., Katlama, C., Gatell, J. M., Lazzarin, A., Vittecoq, D., Charles J Gonzalez, C. J., Chen, J., Harvey, C. M., Isaacs, R. D. (2007): Safety and efficacy of the HIV-1 integrase inhibitor raltegravir (MK-0518) in treatment-experienced patient with multidrug-resistant virus: a phase II randomised controlled trial, *Lancet*, 369, 1261 -1269.
- Kwong, P. D., Wyatt, R., Robinson, J., Sweet, R. W., Sodroski†k, S. R., Hendrickson, W. A. (1998): Structure of an HIVgp120 envelope glycoprotein in complex with the CD4 receptor and a neutralizing human antibody, *Nature*, 393 (6686), 648-659.

- Matthews, T., Salgo, M., Greenberg M., Chung J., DeMasi, R., Bolognesi, D. (2004): Enfuvirtide: the first therapy to inhibit the entry of HIV-1 into host CD4 lymphocytes, *Nat. Rev. Drug. Discov.*, 3 (3), 215-225.
- Mintas, M., Raić-Malić, S. (2009): Medicinska kemija, Zagreb, Medicinska naklada, 370-398.
- Mohanty, U., Dixit, M. N. (2008): Mechanism-based model of the pharmacokinetics of enfuvirtide an HIV fusion inhibitor, *J. Theor. Biol.*, 251, 541–551.
- Palmisano, L., Vella S. (2011): A brief history of antiretroviral therapy of HIV infection: success and challenges, *Ann Ist Super Sanita*, 47 (1), 44-48.
- Planinić, A. (2014): Mutacije povezane s rezistencijom virusa ljudske imunodeficijencije tipa 1 na antiretrovirusne lijekove, doktorska disertacija, Sveučilište u Zagrebu, 4-9.
- Pommier, Y., Johnson, A., Marchan, C. (2005): Integrase inhibitors to treat HIV/AIDS, *Nat. Rev. Drug. Discov.*, 4 (3), 236-248.
- Schrijvers, R., Desimie, B. A., Debyser, Z. (2011): Rilpivirine: a step forward in tailored HIV treatment, *The lancet*, 378 (9787), 201-203.
- Shehu-Xhilaga, M., Oelrichs, R. (2009): Basic HIV virology [http://www.ashm.org.au/images/Publications/Monographs/HIV_Management_Australasia/HIV_Management-Chapter_1.pdf] [27.7. 2014].

Application of antiretroviral therapy in HIV caused infections

Jelena Klenkar*

Josip Juraj Strossmayer University of Osijek, Faculty of Food Technology Osijek,

Franje Kuhača 20, 31 000 Osijek, Croatia

**Corresponding author: jelena.klenkar@gmail.com*

Summary

Since the discovery that AIDS (Acquired immunodeficiency syndrome) is caused by HIV (Human immunodeficiency virus), there have been more drugs developed for HIV infections than for all other viral infections combined. Anti HIV drugs are classified in different categories, depending on which phase of HIV replicative cycle they inhibit. Classes of anti HIV drugs are: nucleoside reverse transcriptase inhibitors (NRTIs; zidovudine (AZT), didanosine (ddI), zalcitabine (ddC), stavudine (d4T), lamivudine (3TC), abacavir (ABC) and emtricitabine), nucleotide reverse transcriptase inhibitors (NtRTIs; tenofovir), non –nucleoside reverse transcriptase inhibitors (NNRTIs; nevirapine, daleviridine, efavirenz and etravirine), protease inhibitors (PI; saquinavir, ritonavir, indinavir, nelfinavir, amprenavir, lopinavir, atazanavir, fosamprenavir, tipranavir i darunavir), inhibitors of the entry of HIV in host cell (fusion inhibitors; FI: enfuvirtid, coreceptor inhibitors; CRI: maraviroc) and integrase inhibitors (INI; raltegravir). To achieve the best possible results, patients today are prescribed with HAART therapy (Highly active antiretroviral therapy) which uses a combination of two, three or more different anti HIV drugs. HAART therapy aims to reduce the risk of resistance development, improve tolerability by targeting more than one phase of replicative cycle of HIV at once.

Keywords: HIV virus, anti-HIV drugs, HAART therapy

Sekcija: Kemijsko i biokemijsko inženjerstvo
Session: Chemical and Biochemical Engineering

Izvorni znanstveni rad

Utjecaj parametara miješanja na utrošak snage u kristalizatoru s dvama aksijalnim turbinskim miješalima

Antonija Kačunić, Marija Ćosić*, Nenad Kuzmanić

Sveučilište u Splitu, Kemijsko-tehnološki fakultet, Zavod za kemijsko inženjerstvo, Ruđera Boškovića 35, 21000 Split, Hrvatska

**Dopisni autor: akrap@ktf-split.hr*

Sažetak

Utrošak snage pri provedbi operacije miješanja može značajno ovisiti o geometrijskim karakteristikama sustava, posebno miješala. U ovom radu sagledan je utjecaj veličine i pozicije miješala na utrošak snage miješanja pri provedbi šaržne prekrystalizacije boraksa. Ispitivanja su provedena u kristalizatoru volumena 15 dm³ u kojem je omjer visine stupca kapljevine i promjera kristalizatora iznosio 1,3. Zbog navedenog omjera miješanje se provodilo dvama aksijalnim turbinskim miješalima s ravnim lopaticama nagnutim pod kutom od 45° (PBT tip miješala). Utjecaj veličine miješala na utrošak snage ispitivan je primjenom miješala različitih promjera, dok je pozicija miješala sagledavana kroz udaljenost donjeg miješala od dna te kroz razmak između miješala. Iz rezultata je uočeno da utrošak snage značajno ovisi o primijenjenim parametrima miješanja. S obzirom da se utrošak sagledavao pri postizanju stanja potpune suspenzije kristala, dobiveni rezultati mogli su se objasniti tek uvidom u strukturu toka kapljevine. U tu svrhu izvršeno je fotografiranje tokova te je analizom slike određen tok kapljevine kojeg razvija pojedino miješalo. Ovisno o veličini i poziciji miješala na slikama je uočeno preklapanje nastalih tokova. Na osnovu provedenih ispitivanja utvrđeno da je utrošak snage pri suspendiranju kristala boraksa ovisi o strukturi sveukupnog toka kapljevine formiranom uslijed djelovanja tokova dvaju miješala. Za suspendiranje kristala boraksa potom je predložena optimalna konfiguracija dvaju aksijalnih miješala.

Ključne riječi: utrošak snage, konfiguracija dvaju miješala, šaržna kristalizacija, boraks dekahidrat

Uvod

Određivanje utroška snage miješanja u reaktorima s miješanjem provodi se u cilju utvrđivanja energetskih zahtjeva određenog sustavima, ali i postupka uvećanja u kojem utrošak snage po jedinici volumena predstavlja ključni parametar. Općenito je poznato da je utrošak snage, P , funkcija brzine vrtnje miješala, N , promjera miješala, D , te karakteristika kapljevine koja se miješala poput dinamičke viskoznosti i gustoće ($P = f(N, D, \rho, \mu, g)$). Međutim, utrošak snage ovisi i o volumenu kapljevine te geometriji sustava koja obuhvaća karakteristike posude, tip miješala, broj i poziciju miješala u sustavu. Geometrija pak sustava ovisi namjeni operacije koja se provodi te značajno utječe na količinu energije koju je potrebno privesti sustavu kako bi se postigla željena kvaliteta izmiješanosti (Tatterson, 1994).

Kemijsko i biokemijsko inženjerstvo / *Chemical and Biochemical Engineering*

U ovom radu ispitan je utrošak snage miješanja u procesu šaržne kristalizacije boraksa. Primjena ove soli je veoma rasprostranjena pa se tako može pronaći u gotovo svim proizvodnim sferama izuzev prehrambene (Sayan, Titiz Sargut, Kiran, 2010). Za komercijalnu primjenu se boraks dobiva uglavnom postupkom šaržne prekrizalizacije rude tinkala u kristalizatorima volumena i do nekoliko desetaka m³. Pritom je visina stupca kapljevine uglavnom veća od promjera reaktora što zahtijeva uvođenja drugog ili više miješala na zajedničku osovinu. Ova promjena, u odnosu na geometrijski standardnu konfiguraciju kristalizatora s mehaničkim miješanjem, rezultira promjenom hidrodinamičkih uvjeta što se može značajno odraziti i na utrošak snage miješanja. Pregledom literature je uočeno da su dosadašnja ispitivanja utroška snage s dvama ili više miješala uglavnom bila fokusirana na postupke miješanja čistih kapljevina, suspendiranje čvrstih inertnih čestica kao i na postupak aeracije (Kuzmanić, Žanetić, Akrap, 2008; Markopoulos, Babalona, Tsiliopoulou, Tasopoulou, 2005; Ascanio, Castro, Galindo, 2004; Armenante, Mazzarotta, Chang, 1998) te gotovo da nema rada u kojem se sagledava utrošak snage miješanja u kristalizatorima s dvama ili više miješala.

S obzirom da se šaržna kristalizacija boraksa provodi u suspenziji miješanje ima značajan utjecaj na ovu operaciju. Na početku procesa kada je u sustavu prisutna isključivo kapljevita faza miješanjem se nastoji ujednačiti prezasićenost unutar otopine. Nakon nukleacije miješanjem se nastoji ostaviti uvjete kojima bi se intenzivirao prijenos tvari i energije tijekom procesa rasta nastalih kristala. Upravo zbog navedenog je potrebno odabrati uvjete miješanja kojima bi se ostvario visoki koeficijent prijenosa tvari. Naime, koeficijent prijenosa tvari naglo raste s povećanjem brzine vrtnje miješala sve dok ona ne postigne vrijednost koja će osigurati postizanje stanja potpune suspenzije. Daljnjim povećanjem brzine vrtnje miješala koeficijent prijenosa tvari se može povećati najviše za 50%, međutim utrošak snage miješanja će u tom slučaju biti deseterostruko veći (Paul, Atiemo-Obeng, Kresta, 2004). S obzirom na navedeno malo je razloga zbog kojih bi se miješanje u kristalizatorima provodilo pri brzinama vrtnje miješala većim od onih potrebnih za postizanje stanja potpune suspenzije.

Cilj ovog rada je ispitati utjecaj parametara miješanja u kristalizatoru s dvama aksijalnim turbinskim miješalima na utrošak snage miješanja u procesu šaržne prekrizalizacije boraksa postupkom kontroliranog hlađenja. Sva ispitivanja provodila su se pri brzini vrtnje miješala pri kojoj je postignuto stanje potpune suspenzije kristala boraksa.

Materijali i metode

Ispitivanja u ovom radu izvršena su u aparaturi prikazanoj na slici 1. Osnovni dio aparature predstavlja kristalizatoru ravnog dna, volumena 15 dm³, promjera $d_T = 0,24$ m. Unutar kristalizatora su ugrađena i četiri razbijala virova ($\beta/d_T=0.1$) čije je dno bilo izvedeno pod kutom od 45° kako bi se izbjeglo nastajanje zona slabije izmiješanosti. Visina stupca kapljevine u kristalizatoru je bila 1,3 puta veća od promjera posude što je zahtijevalo postavljanje drugog miješala na zajedničku osovinu. U ovom istraživanju korištena je konfiguracija sastavljena od dvaju turbinskih miješala s ravnim lopaticama nagnutim pod kutom od 45° (eng. *pitched blade turbine* – PBT). U ispitivanjima se sagledavalo kako promjer miješala, udaljenost donjeg miješala od dna kristalizatora, C , te međusobna udaljenost dvaju miješala na zajedničkoj osovini, S , utječu na utrošak snage miješanja pri suspendiranju kristala boraksa u šaržnom kristalizatoru.

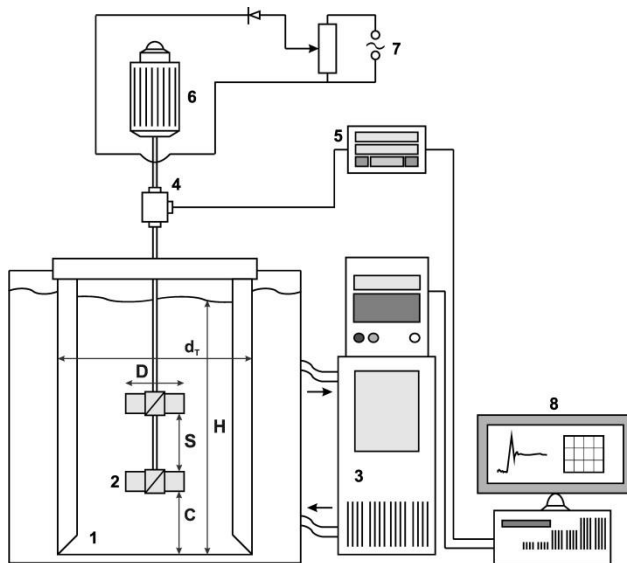

Slika 1. Aparatura za provedbu eksperimenta

(1 - kristalizator, 2 - miješalo, 3 - termostat, 4 - osjetilo zakretnog momenta, 5 - sustav za mjerenje brzine vrtnje miješala i zakretnog momenta, 6 - elektromotor, 7- regulator brzine vrtnje, 8 - računalo).

Fig. 1. Experimental set-up

(1 - crystallizer, 2 - impeller, 3 - thermostat, 4 - torque sensor, 5 - impeller speed and torque measurement system, 6 - electromotor, 7- impeller speed regulator, 8 - computer)

Kao kontinuirana faza pri svim ispitivanjima koristila se otopine boraksa zasićena i termostatirana pri 25°C. Tijekom provedbe eksperimenta podešavana je brzina vrtnje miješala koja je osiguravala postizanje stanja potpune suspenzije kristala, N_{JS} , pomoću uređaja S. Himmelstein & Co. serije 700. Pri postignutoj brzini uređaj je omogućavao i mjerenje zakretnog momenta pomoću osjetila zakretnog momenta smještenog na osovini. Brzina vrtnje miješala pri kojoj se postiže stanje potpune suspenzije ovisi o veličini i masi čestica koje se suspendiraju te o geometrijskim karakteristikama sustava (Zwietering, 1958). Zbog toga je stanje potpune suspenzije bilo potrebno odrediti za kristale boraksa definirane veličine i mase u sustavu s dvama PBT miješalima pri zadanim parametrima miješanja definiranim omjerima D/d_T , C/D i S/D (tablica 1). Veličina kristala boraksa iznosila je $x = 275 \mu\text{m}$, ova veličina predstavlja srednju veličinu najveće klase kristala dobivenih u prethodno provedenim eksperimentima u kristalizatoru manjeg mjerila. Masa kristala za suspendiranje određena iz teorijskog prinosa pri hlađenju zasićene otopine boraksa od 30 do 14 °C. Naime, unutar ovog temperaturnog područja naknadno će se provoditi kristalizacija ispitivane soli. Teorijski prinos izračunat je primjenom izraza:

$$m_s = V \cdot (c_{30}^* - c_{14}^*) \cdot M_s \quad (1)$$

Kemijsko i biokemijsko inženjerstvo / Chemical and Biochemical Engineering

gdje je:

V – volumen matične otopine [m^3],

C_{30}^* – koncentracija zasićene matične otopine na početku procesa kristalizacije [kmol/m^3],

C_{14}^* – koncentracija zasićene matične otopine na kraju procesa kristalizacije [kmol/m^3], a

M_S – molarna masa kristalizirajuće soli [kg/kmol].

Tablica 1. Ispitivani parametri miješanja

Table 1. Examined mixing parameters.

D/d_T	C/D	S/D
0,27	0,20	0,00
0,33	0,60	0,50
0,40	1,00	1,00
	1,30	1,50

Stanje potpune suspenzije određivano je vizualnom metodom koju su predložili Eineinkel i Mersmann (1977). Prema navedenoj metodi, stanje potpune suspenzije ostvareno je pri onoj brzini vrtnje miješala pri kojoj se oblak suspenzije podigne do 90% visine stupca kapljevine ($0,9 H$). Bitno je napomenuti kako je u svim ispitivanim sustavima istovremeno bio zadovoljen i Zwieteringov kriterij za određivanje stanja potpune suspenzije prema kojem se nijedna čestica ne zadržava na dnu posude duže od 1 do 2 sekunde. Kako je vizualna metoda određivanja stanja potpune suspenzije subjektivna, sva mjerenja su provedena najmanje deset puta te je potom izračunata srednja vrijednost N_{JS} .

Da bi se dobio uvidi u hidrodinamička zbivanja u sustavu s dvama PBT miješalima, pri ispitivanim uvjetima miješanja, izvršeno je fotografiranje toka suspenzije i to u tamnoj sobi prema metodi koju su koristili Ibrahim i Nienow (1995). Prilikom snimanja stupac suspenzije bio je osvijetljen halogenom lampom, snage 1500 W, pri čem je svjetlo prolazilo kroz dva paralelna otvora širine 5 mm, dok su ostali dijelovi kristalizatora bili zatamnjeni. Kao traser korišteni su kristali boraksa srednje veličine 275 μm , dok je kontinuirana faza bila otopina boraksa zasićena pri 25°C.

Rezultati i rasprava

Snaga miješanja definira se kao količina energije koju je potrebno privesti sustavu uslijed mehaničkog miješanja da bi se ostvarilo strujanje fluida u reaktoru. U ovom radu utrošak snage izračunat je iz vrijednosti brzine vrtnje miješala pri postizanju stanja potpune suspenzije, N_{JS} , i zakretnog momenta, τ , primjenom izraza:

$$P = N_{JS} \cdot \tau \cdot 2\pi \quad (2)$$

Utrošak snage izražen je po jedinici mase suspenzije koja se miješa, P/m .

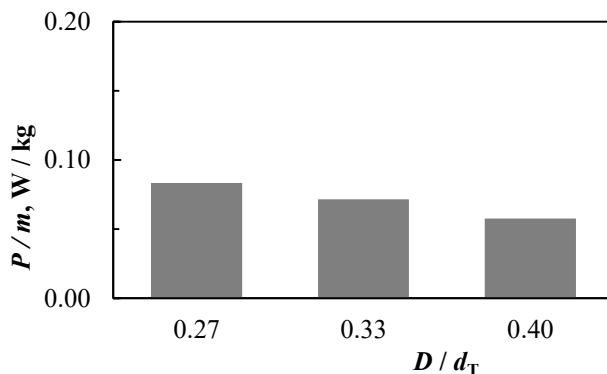

Slika 2. Utrošak snage miješanja pri različitim promjerima miješala u sustavu s dvama PBT miješalima

Fig. 2. Power consumption at different impeller diameters in PBT dual-impeller system

Na slici 2 prikazan je utrošak snage miješanja pri tri različita promjera miješala izražena omjerom D/d_T . Iz rezultata se uočava da se s povećanjem veličine miješala utrošak snage smanjuje. Kako se s povećanjem veličine miješala povećava i projicirana površina miješala očekivalo bi se da će se povećanjem miješala povećavati utrošak snage, odnosno energija koju treba narinuti kako bi veće miješalo pri okretanju savladalo otpor kojeg mu pruža kapljevina. Međutim, kako se u ovim ispitivanjima miješanje provodilo pri stanju potpune suspenzije kristala boraksa svakako treba sagledati i vrijednosti N_{JS} pri analizi dobivenih rezultata. Na slici 3 prikazana je ovisnost brzine vrtnje miješala pri postizanju stanja potpune suspenzije i zakretnog momenta o promjerima PBT-PBT konfiguracije miješala.

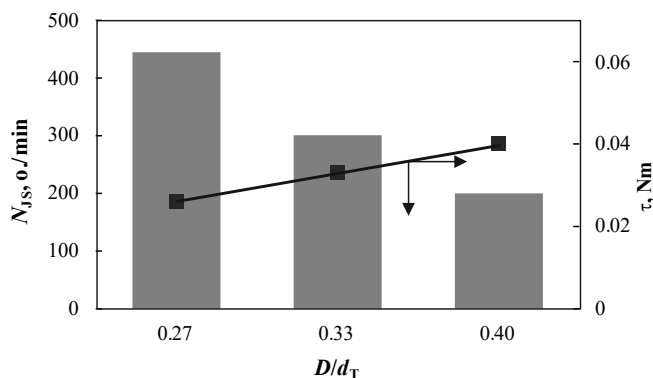

Slika 3. Promjene brzine vrtnje miješala i zakretnog momenta s promjenom promjera miješala pri stanju potpune suspenzije

Fig. 3. Variation of just suspended impeller speed and torque at different impeller diameter in PBT dual-impeller system

Kemijsko i biokemijsko inženjerstvo / Chemical and Biochemical Engineering

Iz slike je evidentno da se povećanjem promjera miješala N_{JS} smanjuje. Detaljnijom analizom rezultata utvrđeno je da je povećanje promjera miješala za 48 % uzrokovao je smanjenje brzine vrtnje miješala potrebnu za postizanje stanja potpune suspenzije za više od 55 %. Ovakav rezultat posljedica je djelovanja strukture sveukupnog toka kapljevine u sustavu s dvama PBT miješalima. Naime, svako od dvaju PBT miješala razvija svoj karakteristični tok; kapljevina zahvaćena miješalom se usmjerava prema dnu posude odakle struji uz stijenku kristalizatora prema površini. Kako su u sustavu prisutna dva PBT miješala uzlazni tok donjeg miješala pridružuje se uzlaznom toku gornjeg miješala formirajući na taj način jednocirkulacijski tok kapljevine unutar sustava (slika 4a). S povećanjem promjera miješala nastali jednocirkulacijski tok biva širi što omogućava podizanje kristala boraksa s dna kristalizatora i njihovo nesmetano podizanje do visine $0,9 H$ već pri značajno manjem iznosu N_{JS} .

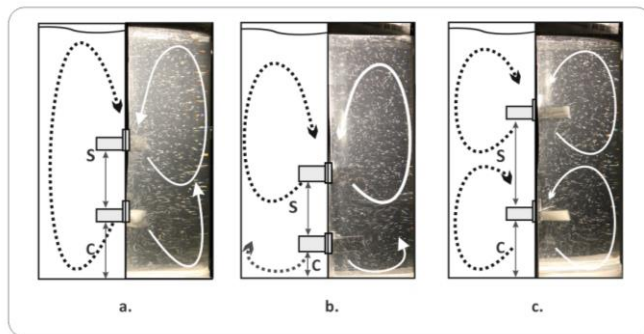

Slika 4. Struktura toka kapljevine u kristalizatoru s dvama PBT miješalima pri a.) $C/D=1,0$, $S/D=1,0$, $D/d_T=0,33$; b.) $C/D=0,20$, $S/D=1,0$, $D/d_T=0,33$; c) $C/D=1,0$, $S/D=1,5$, $D/d_T=0,33$
Fig. 4. Fluid flow pattern in the PBT dual-impeller crystallizer at a.) $C/D=1,0$, $S/D=1,0$, $D/d_T=0,33$; b.) $C/D=0,20$, $S/D=1,0$, $D/d_T=0,33$; c) $C/D=1,0$, $S/D=1,5$, $D/d_T=0,33$

Općenito je poznato da je za suspendiranje čestica s dna reaktora odgovorno makromjerilo turbulencije u kojem je veličina makrovtloga proporcionalna promjeru miješala. Pri suspendiranju kristala boraksa s dna reaktora kapljevina treba osigurati dovoljnu veličinu i energiju vrtloga, odnosno brzinu kapljevine pri dnu kristalizatora, da bi se ostvarilo suspendiranje prisutnih kristala. S povećanjem veličine miješala povećava se veličina makrovtloga ali i dobava miješala. Naime, miješalo većih dimenzija zahvaća i odbacuje veću količinu kapljevine prema dnu kristalizatora nepromijenjenog presjeka. Zbog toga, miješalo povećanog promjera može već pri manjoj brzini vrtnje osigurati brzinu kapljevine potrebnu za podizanje sedimentirajućih kristala boraksa. Važno je napomenuti da, s obzirom da je kriterij postizanja stanja potpune suspenzije bio $0,9 H$, veće miješalo uslijed većeg primarnog vrtloga, učinkovitije pridonosi podizanju kristala na ovu visinu. Na slici 3 se uočava povećanje zakretnog momenta s povećanjem promjera miješala. Iznos zakretnog momenta općenito raste s povećanjem brzine vrtnje miješala, no u ovom slučaju njegovo povećanje se može pripisati prethodno opisanom povećanom otporu kojeg kapljevina pruža rotaciji miješala pri povećanju njegovog promjera. Dakle, dok je N_{JS} posljedica strukture ukupnog toka kapljevine, τ je posljedica povećanja promjera miješala.

Prema tome, na osnovu odnosa eksperimentalnih vrijednosti N_{JS} i τ može se reći da je smanjenje utroška snage s povećanjem miješala posljedica nastalih promjena u strukturi toka kapljevine. Prilikom sagledavanja utjecaja udaljenosti donjeg miješala od dna kristalizatora izraženog omjerom C/D na utrošak snage miješanja uočeno je da se s povećanjem udaljenosti miješala povećava i utrošak snage (slika 5).

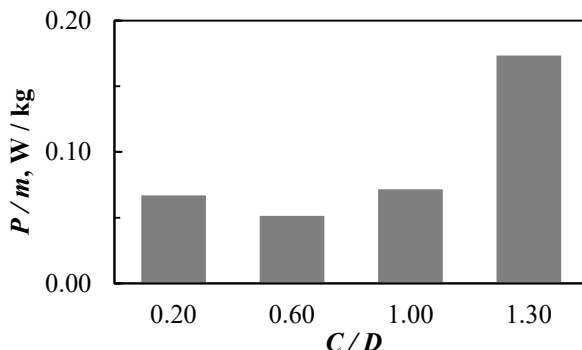

Slika 5. Utrošak snage miješanja u ovisnosti o udaljenosti donjeg miješala od dna kristalizatora u sustavu s dvama PBT miješalima

Fig. 5. Power consumption at different impeller off-bottom clearances in PBT dual-impeller system

Razlike u vrijednostima utroška snage pri ispitivanim omjerima C/D i u ovom slučaju ovise o vrijednostima N_{JS} i τ odnosno o karakteristikama sveukupnog toka kapljevine odgovornog za uklanjanje kristala s dna kristalizatora i njihovo podizanje na 90% visinu stupaca kapljevine. Promjene N_{JS} i τ s udaljavanjem donjeg miješala od dna kristalizatora prikazane su na slici 6.

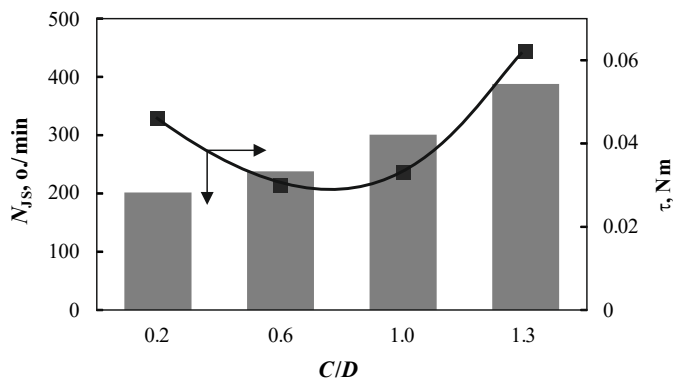

Slika 6. Promjene brzine vrtnje miješala i zakretnog momenta s udaljenošću donjeg miješala od dna, pri stanju potpune suspenzije

Fig. 6. Variation of just suspended impeller speed and torque at different impeller off-bottom clearances in PBT dual-impeller system

Kemijsko i biokemijsko inženjerstvo / Chemical and Biochemical Engineering

Kako bi se objasnili međuovisnost vrijednosti N_{JS} o omjeru C/D potrebno je analizirati strukturu toka PBT miješala. Općenito se tok kapljevine kojeg razvija PBT miješalo može podijeliti na tri zone (Bakker, Myer, Ward, Lee, 1996). Ispod miješala se nalaze zona velikih brzina fluida (I.) i zona manjih brzina fluida konusnog oblika (II.). Zonu velikih brzina fluida formira tzv. primarni cirkulacijski tok koji struji od miješala prema dnu, odnosno kutovima kristalizatora. U zoni manjih brzina (II), a uslijed međudjelovanja primarnog cirkulacijskog toka i okoline generira se manji sekundarni tok suprotnog smjera (tzv. reverzni tok) koji je pozicioniran neposredno ispod miješala. Postojanje sekundarnog toka su u sustavu s jednim PBT miješalom uočili Bakker i suradnici (1996) te Kumaresan i Joshi (2006) pri analizi toka ovog miješala metodom laserske doppler anemometrije (LDA). Treća zona (III.) okarakterizirana najmanjim brzinama kapljevine nalazi se iznad PBT miješala, neposredno ispod površine kapljevine. Kako su u sustavu prisutna dva PBT miješala pozicioniranjem donjeg miješala bliže dnu ($C/D = 0,2$) dolazi do kompresije toka donjeg miješala (slika 4b). Međutim unatoč činjenici da je došlo do kompresije toka donjeg miješala, prisutni hidrodinamički uvjeti imaju značajan utjecaj na suspendiranje sedimentiranih kristala s obzirom da je upravo pri ovom omjeru C/D suspendiranje postignuto pri najnižoj vrijednosti N_{JS} . U ovom slučaju postupku suspendiranja su očito pogodovale brzine kapljevine u zoni miješala. Naime u zoni miješala, bez obzira na tip miješala postoji najizraženije smicanje, odnosno najveći gradijent brzina koje, postavljajući se blizu sedimentirajućih kristala, pospješuju suspendiranje. S druge strane, udaljavanjem donjeg miješala od dna kristalizatora opseg sekundarnog, reverznog, toka donjeg miješala se povećava pri čemu dolazi do smanjenja intenziteta toka ispod donjeg miješala te sveukupni tok ima sve manje utjecaja na zbivanja na dnu kristalizatora. Zbog toga je upravo i pri najvećoj udaljenosti donjeg miješala bilo potrebno narinuti i najveću brzinu vrtnje miješala kako bi se postiglo suspendiranje kristala. Ukoliko se analizira promjena zakretnog momenta s promjenom omjera C/D uočeno je da se τ povećava s povećanjem brzine vrtnje miješala u području $0,6 < C/D \leq 1,3$ međutim pri $C/D=0,2$ ova veličina je povećana unatoč manjoj vrijednosti N_{JS} . Navedeno povećanje se može pripisati nedovoljno razvijenom toku donjeg miješala uslijed kompresije. Pri sagledavanju utroška snage o međusobnoj ovisnosti dvaju miješala izraženih omjerom S/D uočeno je kako se utrošak snage smanjuje s povećanjem udaljenosti između miješala (slika 7).

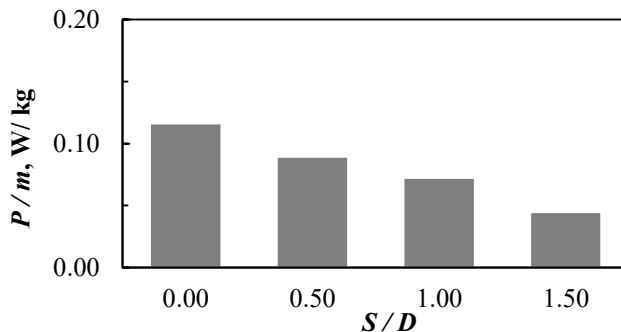

Slika 7. Utrošak snage miješanja pri različitim međusobnim udaljenostima dvaju PBT miješala
Fig. 7. Power consumption at different impeller spacing in PBT dual-impeller system

Ukoliko se uz ovaj utrošak snage, analogno prethodnim, sagledava i promjene vrijednosti N_{JS} uočava se da s povećanjem omjera S/D ova veličina tek neznatno povećava te da je pri omjerima $S/D \geq 1,0$ gotovo identična (slika 8).

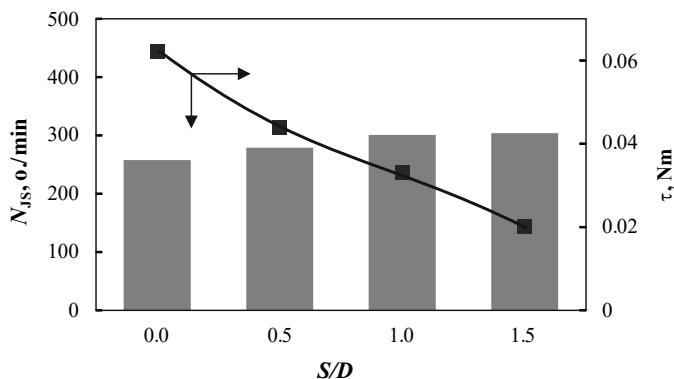

Slika 8. Promjene brzine vrtnje miješala i zakretnog momenta s međusobnom udaljenošću dvaju PBT miješala pri stanju potpune suspenzije

Fig. 8. Variation of just suspended impeller speed and torque at different impeller spacing in PBT dual-impeller system

Pri omjeru $S/D=0$ miješala su spojena te se ponašaju kao jedno izmijenjenih geometrijskih karakteristika. Ovakvo miješalo ima izražena smična naprezanja koja očitog pogoduju postupku suspendiranja kristala boraksa s obzirom na nešto niže vrijednosti N_{JS} . Pri omjerima $0,5 < S/D < 1,0$ tokovi miješala udružuju u prethodno opisani jednocirkulacijski tok (slika 4a). Međutim pri omjeru $S/D = 1,5$ u sustavu je uočeno da se tokovi dvaju miješala ne preklapaju, odnosno uočeno je postojanje dvaju nezavisnih tzv. paralelnih tokova kapljevine (slika 4c). Na osnovu vrijednosti N_{JS} može se zaključiti da se formiranje paralelnih tokova nije značajnije odrazilo na suspendiranje kristala. U ovom slučaju potpuno razvijeni tok donjeg miješala podiže kristale na određenu visinu stupca kapljevine odakle ih tok gornjeg miješala podiže na visinu $0,9H$. S druge strane, iz slike 7 uočava se da se zakretni moment značajno smanjuje s povećanjem omjera S/D te da utrošak snage pri povećanju udaljenosti između miješala više ovisi o vrijednostima zakretnog momenta nego o N_{JS} . Ovakav trend ukazuje da je zakretni moment to veći ukoliko ne dolazi do potpunog razvijanja tokova miješala, što je prethodno bio slučaj i pri $C/D=0,2$. Nadalje, vrijednost zakretnog momenta opada s formiranjem nezavisnih, paralelnih tokova. Pri omjeru $S/D=0$ povećana vrijednost zakretnog momenta posljedica je, slično kao i pri povećanju promjera miješala, povećanja veličine miješala.

Usporedbom rezultata ispitivanja konfiguracije dvaju PBT miješala na utrošak snage miješanja uočeno je da je najmanji utrošak snage prisutan kada se miješanje provodi pri omjerima $C/D=1$, $S/D=1,5$, $D/d_T=0,33$. Međutim za provedbu procesa kristalizacije osim najnižeg utroška snage, svakako treba sagledati i karakteristike produkta kristalizacije pri ispitivanim parametrima, kako bi se odabrala optimalna konfiguracija.

Zaključci

Najniže vrijednosti utroška snage miješnja pri suspendiranju kristala boraksa u sustavima s dvama PBT miješalima postižu se povećanjem međusobne udaljenosti miješala do pozicije koja će rezultirati formiranjem dvaju paralelnih tokova. Pri tome je sniženi utrošak snage posljedica smanjenja vrijednosti zakretnog momenta. Utrošak snage miješanja u ispitivanim sustavima smanjuju se također s povećanjem promjera miješala te smanjenjem udaljenosti donjeg miješala od dna kristalizatora. Pri ovim uvjetima smanjeni utrošak snage posljedica je značajnog sniženja vrijednosti N_{JS} zbog povećanja veličine makrovtloga, odnosno zbog blizine zone miješala, okarakterizirane velikim brzinama kapljevine, sedimentiranim kristalima.

Zahvala: Istraživanja u ovom radu sastavni su dio istraživanja obuhvaćenih znanstvenim projektom HETMIX (IP-11-2013-8959) kojeg financira Hrvatska zaklada za znanost.

Literatura

- Armenante, P. M., Mazzarotta, B., Chang, G.-M. (1998): Power Consumption in Stirred Tanks Provided with Multiple Pitched-Blade Turbines, *Ind. Eng. Chem. Res.* 37 (1), 284–291.
- Ascanio, G., Castro, B., Galindo, E. (2004): Measurement of Power Consumption in Stirred Vessels—a Review, *Chem. Eng. Res. Des.* 82, 1282–1290.
- Bakker, A., Myer, K. J., Ward, R.W., Lee, C. K. (1996): The Laminar and Turbulent Flow Pattern of a Pitched Blade Turbine. *Trans IChemE* 74 (A), 485–491.
- Einenkel, W. D., Mersmann, A. (1977): The Agitator Speed for Particle Suspension, *Verfahrenstechnik* 11, 90–94.
- Ibrahim, S., Nienow, A. W. (1995): Power Curves and Flow Patterns for a Range of Impellers in Newtonian Fluids: $40 < Re < 5 \times 10^5$, *Trans IChemE* 73, 485–491.
- Kumaresan, T., Joshi, J. B. (2006): Effect of Impeller Design on the Flow Pattern and Mixing in Stirred Tanks, *Chem. Eng. J.* 115 (3), 173 – 193.
- Kuzmanić, N., Žanetić, R., Akrap, M. (2008): Impact of Floating Suspended Solids on the Homogenisation of the Liquid Phase in Dual-Impeller Agitated Vessel, *Chem. Eng. Process.* 47 (4), 663–669.
- Markopoulos, J., Babalona, E., Tsiliopoulou, E., Tasopoulou, K. (2005): Power Consumption in Agitated Vessels with Dual Pitched Blade Turbines: Baffle Length and Impeller Spacing Effects, *Chem. Eng. Technol.* 28, 978–981.
- Paul, E. L., Atiemo-Obeng, V., Kresta, S. M. (2004): Handbook of Industrial Mixing, New Jersey, USA: John Wiley & Sons, pp. 345–391.
- Tattersson, G. B. (1994): Scale-up and Design of Industrial Mixing Processes, New York, USA: McGraw-Hill, pp. 1–53.
- Sayan, P., Titiz Sargut, S., Kiran, B. (2010): Effect of Impurities on the Microhardness of Borax Decahydrate, *Powder Technol.* 197, 254–259.
- Zwietering, N. (1958): Suspending of Solid Particles in Liquid by Agitators, *Chem. Eng. Sci.* 8, 244–253.

Original research paper

Influence of mixing parameters on power consumption in dual axial impeller crystallizer

Antonija Kaćunić, Marija Ćosić*, Nenad Kuzmanić

*University of Split, Faculty of Chemistry and Technology, Department of Chemical Engineering,
Ruđera Boškovića 35, 21000 Split, Croatia
Corresponding author: akrap@ktf-split.hr

Summary

Power consumption in agitated vessel depends on geometrical characteristics of system, especially impeller configuration. In this work the influence of impeller size and position on power consumption in batch cooling crystallization of borax decahydrate was analyzed. Examinations were conducted in a crystallizer of 15 dm³ with liquid height to crystallizer diameter *ratio* (H/d_T) of 1,3. This aspect ratio required the use of a second impeller on the same shaft. In this research, mixing was performed by two 45° four-bladed pitched blade turbines (PBT). Influence of impeller size was analyzed by using impellers of different diameters, while the impeller position was analyzed by varying impeller off-bottom clearance and spacing between impellers. From the results it was found that power consumption depends on applied mixing parameters. Since power consumption was analyzed at the state of complete suspension of crystals, obtained results could only be explained by analyzing the fluid flow pattern in the vessel. For that reason, photographs of the fluid streams in the crystallizer were taken. Depending on the impeller size and position, a more or less pronounced interaction of the flows developed by each of impeller applied was observed in the photographs. Based on the results of this examination, it was found that power consumption depends on the overall fluid flow pattern which is a result of the interaction of each of the impellers fluid flow. In the end, an optimal configuration of dual axial impeller system for the suspension of crystals of borax was suggested.

Keywords: power consumption, dual-impeller configuration, batch cooling crystallization, borax decahydrate

Izvorni znanstveni rad

Fizikalna svojstva prirodnih eutektičkih smjesa

Anamarija Mitar¹, Jasna Prlić Kardum^{1*}, Aleksandra Sander¹,
Ivana Radojčić Redovniković²

¹*Sveučilište u Zagrebu, Fakultet kemijskog inženjerstva i tehnologije,
Marulićev trg 20, 10000 Zagreb, Hrvatska*

²*Sveučilište u Zagrebu, Prehrambeno biotehnološki fakultet,
Pierottijeva 6, 10000 Zagreb, Hrvatska*

**Dopisni autor: jprlic@fkit.hr*

Sažetak

Izbor otapala u industrijskim procesima zahtjevan je postupak budući da korištenje konvencionalnih, hlapljivih i zapaljivih organskih otapala može predstavljati opasnost za ljudsko zdravlje, okoliš, ali i problem pri njegovu zbrinjavanju. Upravo stoga istraživanje i primjena prirodnih eutektičkih smjesa, u različitim procesima, predstavlja iskorak ka smanjenju negativnog utjecaja industrije na okoliš. Ova otapala moguća su alternativa postojećoj tehnologiji i nude zamjenu štetnim otapalima. Prirodne eutektičke smjese pripremaju se iz jeftinih, netoksičnih te lako dostupnih komponenti. Kako je njihova primjena u industriji još uvijek u začetku, a mogućnost kombiniranja donora i akceptora vodikovih veza beskonačna, nedostaju podaci o osnovnim fizikalno-kemijskim svojstvima.

U ovom radu određena je: gustoća, viskoznost, električna vodljivost, indeks loma te pH vrijednost osam pripremljenih prirodnih eutektičkih smjesa u rasponu temperature od 288 do 328 K. Također je određen i utjecaj udjela vode u eutektičkoj smjesi na navedena fizikalna svojstva. Sve pripremljene eutektičke smjese su Newtonski fluidi, čija se gustoća kreće od 1100 do 1500 kg m⁻³ ovisno o udjelu dodane vode. Povišenjem temperature i povećanjem udjela vode viskoznost i indeks loma padaju, dok električna vodljivost raste. Ovisnost indeksa loma, pH vrijednosti i električne vodljivosti sa promjenom temperature je linearna, dok je promjena viskoznosti s temperaturom opisana Arrheniusovom te Vogel-Fulcher -Tammanovom jednačbom.

Ključne riječi: električna vodljivost, eutektičke smjese, gustoća, indeks loma, pH vrijednost, viskoznost

Uvod

Postojeća zelena tehnologija nastoji u raznim istraživanjima, ali i u komercijalnim procesima primijeniti nove, za okoliš prihvatljive tehnologije. Ove se, tzv. zelene tehnologije, odvijaju pri blagim uvjetima tlaka i temperature, a energetski su učinkovite te primjenjuju neopasna zelena otapala. Hlapljiva organska otapala koja se koriste u komercijalnim procesima u velikim količinama, većinom su toksična, zapaljiva i korozivna, a njihovo recikliranje i ponovna upotreba zahtijevaju primjenu visoko energetskih postupaka uz znatne gubitke, poput destilacije. Razvoj novih za okoliš prihvatljivih dizajniranih otapala, otvara mnoge opcije i mogao bi znatno doprinijeti

napretku zelenih tehnologija. Prirodna eutektička otapala (*deep eutectic solvents*, DES) privukla su veliku pažnju kao zamjenska otapala komercijalno korištenim hlapljivim otapalima, a imaju i veliki potencijal za primjenu u raznim procesima poput ekstrakcije (Gano i sur., 2015., Oliveira i sur., 2013.) organske sinteze (Gore i sur., 2011.) te u elektrokemiji (Jhong i sur., 2009.). Primjena eutektičkih smjesa kao novih vrsta otapala nastavak je primjene ionskih kapljevine (IK). Naime, ionske kapljevine se već duže vrijeme proučavaju i do sada u komercijalnoj upotrebi postoji oko 250 različitih ionskih kapljevine (Zhang i sur., 2011.). Obzirom da većina ionskih kapljevine, usprkos nizu izuzetnih svojstava, ipak nije ekološki prihvatljiva, bilo zbog sinteze iz toksičnih organskih spojeva, nastalih nusprodukata ili zbog njihove toksičnosti, novija istraživanja uključuju niskotemperaturne eutektičke smjese. Niskotemperaturne eutektičke smjese zadovoljavaju principe zelene kemije, a posjeduju svojstva analogna svojstvima ionskih kapljevine. Veza između ionskih kapljevine i eutektičkih otapala je u sličnim fizikalnim svojstvima (gustoća, viskoznost, indeks loma, površinska napetost), pri sobnoj temperaturi su kapljevine, neznatne su hlapljivosti, nezapaljiva su i posjeduju veliku toplinsku, kemijsku i elektrokemijsku stabilnost. Kada se govori o prednostima eutektičkih smjesa, naglasak se stavlja na netoksičnost, pristupačnu cijenu te jednostavan postupak sinteze u kojem se koriste jeftine, obnovljive i biorazgradive komponente koje su sposobne pri blagim uvjetima sinteze tvoriti eutektičku smjesu. Nadalje, sve biljke obiluju primarnim metabolitima kao što su lipidi, nukleotidi, aminokiseline i organske kiseline, a njihovo se stanje u organizmu mijenja iz krutog u kapljevitost kad se pomiješaju u odgovarajućem omjeru. Zbog toga se može pretpostaviti da prirodna niskotemperaturna eutektička otapala (*natural deep eutectic solvents*, NADES) igraju ulogu alternativnog medija u živim organizmima u odnosu na vodu. Ta je pretpostavka rezultirala otkrićem više od 100 prirodnih eutektičkih smjesa. Sve ispitane prirodne eutektičke smjese jasno pokazuju postojanje vodikove veze između komponenti što je odlika eutektičkih otapala (Dai i sur., 2013.). Unatoč sve većoj važnosti te brojnim različitim primjenama i čitavom nizu prednosti pred drugim otapalima, podaci o osnovnim fizikalnim svojstvima još uvijek nedostaju za mnoga eutektička otapala. U ovom radu određena su fizikalna svojstva prirodnih eutektičkih smjesa poput gustoće, viskoznosti, indeksa loma, pH vrijednosti i električne vodljivosti kao i utjecaj temperature te udjela vode na navedena fizikalna svojstva.

Materijali i metode

Pripremljeno je osam prirodnih eutektičkih otapala te su im eksperimentalno određena fizikalna svojstva (gustoća, viskoznost, indeks loma, pH vrijednost i električna vodljivost) u temperaturnom intervalu 288 do 328 K (osim za gustoću koja je za sva otapala određena pri 298 K). Eutektička otapala pripravljena su sa udjelom vode 10, 30 i 50 mas%. Molarni omjeri donora i akceptora vodikove veze u korištenim eutektičkim smjesama dani su u tablici 1. Za termostatiranje svih pripremljenih otapala tijekom mjerenja navedenih fizikalnih svojstava korišten je termostat *model F 12 Julabo*.

Priprema prirodnih eutektičkih otapala

Prirodna eutektička otapala sintetizirana su određenom molarnom omjeru kako je dano u tablici 1. Netom prije sinteze, komponente se suše u vakuumskom sušioniku (*Savant SPD131DDA Speed Vac Concentrator, Thermo scientific, USA*) pri temperaturi od 333 K tijekom 24 h. Dvije ili više komponenti dodaju se u određenom molarnom omjeru u staklenu posudu, miješaju sa 10, 30 ili 50 mas% vode te zagrijavaju na temperaturu 333 K te miješaju do pojave bistre, bezbojne kapljevine.

Kemijsko i biokemijsko inženjerstvo / Chemical and Biochemical Engineering

Mjerenje gustoće

Gustoće pripremljenih eutektičkih otapala izmjerene su digitalnim uređajem za mjerenje gustoće, *Mettler Toledo Densito 30PX* točnosti instrumenta od $\pm 0,1 \text{ kg m}^{-3}$, odnosno areometrom za eutektička otapala čiji je $\text{pH} < 3$. Gustoće su izmjerene pri sobnoj temperaturi. Bez obzira na način mjerenja gustoće, mjerenje svakog uzorka ponovljeno je tri puta te je određena srednja vrijednost gustoće.

Tablica 1. Pripravljena prirodna eutektična otapala (NADES) s masenim udjelom vode od 10, 30 i 50%

Table 1. Prepared natural eutectic solvents with mass fraction of water of 10, 30 and 50%

DES	Oznaka	Molarni omjer
Betain: jabučna kiselina	B-Ma	1:1
Betain: limunska kiselina	B-Cit	1:1
Kolin klorid: jabučna kiselina	CH-Ma	1:1
Kolin klorid: prolin: jabučna kiselina	CH-Pro-Ma	1:1:1
Jabučna kiselina: glukoza: glicerol	Ma-Glu-Gly	1:1:1
Prolin: jabučna kiselina	Pro-Ma	1:1
Kolin klorid: limunska kiselina	CH-Cit	2:1
Jabučna kiselina: glukoza	Ma-Glu	1:1

Mjerenje viskoznosti

Reološka svojstva ispitivanih sintetiziranih eutektičkih otapala određena su na termostatom *Brookfieldovom reometru DV – III ULTRA* primjenom koncentričnog vretena *SC4-21*, odnosno za eutektička otapala većih viskoznosti ($\eta > 2 \text{ Pas}$), primjenom koncentričnog vretena *LV4*. Mjerenje reoloških svojstava provedeno je praćenjem ovisnosti smičnog naprezanja, τ o smičnoj brzini, $\dot{\gamma}$ pri maksimalnoj smičnoj brzini od 182 s^{-1} , odnosno za eutektička otapala većih viskoznosti do smične brzine $5,67 \text{ s}^{-1}$. Mjerenja su provedena u temperaturnom području od 288 do 328 K. Iz ovisnosti smičnog naprezanja o smičnoj brzini određen je reološki model ponašanja eutektičkog otapala te njegova viskoznost. Točnost instrumenta za mjerenje viskoznosti sa korištenim vretenima iznosi $\pm 1,0\%$.

Mjerenje indeksa loma

Indeks loma eutektičkih otapala izmjeren je na Abbeovom refraktometru, *Optech* točnosti $\pm 0,0001$ u rasponu temperatura 288-328 K. Mjerenje indeksa loma svakog uzorka ponovljeno je tri puta te je određena srednja vrijednost.

Mjerenje pH vrijednosti i električne vodljivosti

pH vrijednost i električna vodljivost ispitivanih eutektičkih otapala izmjerene su pomoću uređaja *WTW InoLab pH/Cond 740* (pH electrode *SenTix 81*; konduktometrijska elektroda: *WTW Tetracon 325*) u rasponu temperatura 288-328 K. Točnosti uređaja za mjerenje pH vrijednosti iznosi $\pm 0,004$ pH, a za mjerenje električne vodljivosti $\pm 0,0002 \text{ V}$. Za održavanje konstantne temperature eutektičkih otapala tijekom mjerenja korišten je ranije spomenuti termostat.

Rezultati i rasprava

Svrha ovog rada bila je ispitati fizikalna svojstva: gustoću, viskoznost, električnu vodljivost, pH vrijednost i indeks loma prirodnih eutektičkih otapala sa različitim sadržajem vode. Navedena fizikalna svojstva, osim gustoće ispitana su za temperaturno područje od 288-328 K.

Gustoća i viskoznost

Gustoća i viskoznost su osnovna fizikalna svojstva bitna u proračunima mehanizama prijenosa i za dizajn kemijskih procesa. Eutektičke smjese velike gustoće u nekim su slučajevima nepogodne za provođenje kemijskih procesa zbog negativnog utjecaja na miješanje i rukovanje procesom, međutim veće razlike u gustoćama imaju pozitivan utjecaj npr. na proces ekstrakcije radi lakšeg razdvajanja faza. Gustoće 8 ispitivanih DESova sa različitim sadržajem vode izmjerene su pri 298 K. Vrijednosti gustoća su u rasponu od 1130 kg m^{-3} do 1500 kg m^{-3} ovisno o sadržaju vode i sastavu eutektičkog otapala. Najveća vrijednost standardne devijacije za izmjerene gustoće iznosi $\pm 0,4 \text{ kg m}^{-3}$. Gustoća otapala ovisi o organizaciji molekula odnosno o molekularnoj masi i o tome koliko su jake međumolekulske sile. Kada su eutektička otapala, analogno ionskim kapljevinama, sastavljena od šupljina i praznih prostora pa njihova fizikalna svojstva ovisе o prostornoj orijentaciji molekula te međuprostoru koji se formira.

Gustoća se smanjuje s povećanjem temperature zbog povećanja kinetičke energije u sustavu pa je smanjenje gustoće uzrokovano intenzivnijim gibanjem molekula i povećanjem slobodnog prostora između istih. Nadalje, ovisna je i o udjelu vode (slika 1.) te se smanjuje s povećanjem njezinog udjela, a dokazano je i da omjer organske soli i donora vodikove veze utječe na njezin iznos. (Abbott i sur., 2003.).

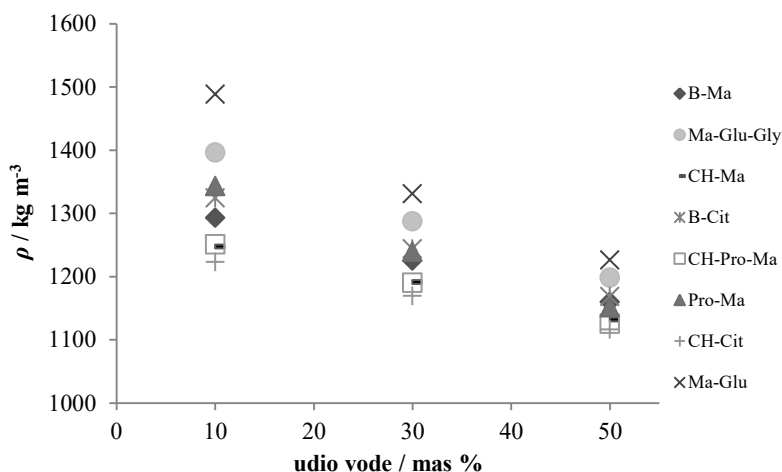

Slika 1. Gustoće DES-a u ovisnosti o masenom udjelom vode pri 298 K
Fig. 1. Densities of DESs as function of the mass fraction of water at 298 K

Kemijsko i biokemijsko inženjerstvo / Chemical and Biochemical Engineering

Najveću gustoću ima eutektička smjesa Ma-Glu koja u svom sastavu ima molekule glukoze. Poznato je da duži ugljikovi lanci donora vodikove veze (HBD) reduciraju interakcije vodikovih veza zbog prostornih smetnji što rezultira značajnim smanjenjem gustoće. Najveća gustoća eutektičke smjese Ma-Glu pripravljene s glukozom koja u svojoj strukturi ima 6 ugljikovih atoma, može se objasniti velikom gustoćom same glukoze ($1534,5 \text{ kg m}^{-3}$ na sobnoj temperaturi) i prstenastom strukturom koju molekula formira. Najmanje gustoće izmjerene su za eutektičke smjese pripravljene sa kolin kloridom. Uz navedeno, značajno je primijetiti da je gustoća čistog kolin klorida $1185,6 \text{ kg m}^{-3}$.

Viskoznost kapljevine u velikoj mjeri utječe na odabir pogodnog otapala u nekom separacijskom procesu. Određivanjem reoloških svojstava nađeno je da su sva ispitivana eutektička otapala Newtonovski fluidi te je u cijelom temperaturnom području ovisnost smičnog napreznja, τ o smičnoj brzini, $\dot{\gamma}$ linearna. Otapala velike viskoznosti nisu pogodna za pojedine procese jer mogu uzrokovati poteškoće u procesima miješanja, filtriranja itd. Viskoznost eutektičkih otapala moguće je smanjiti povećanjem udjela vode ili povišenjem temperature (slika 2.).

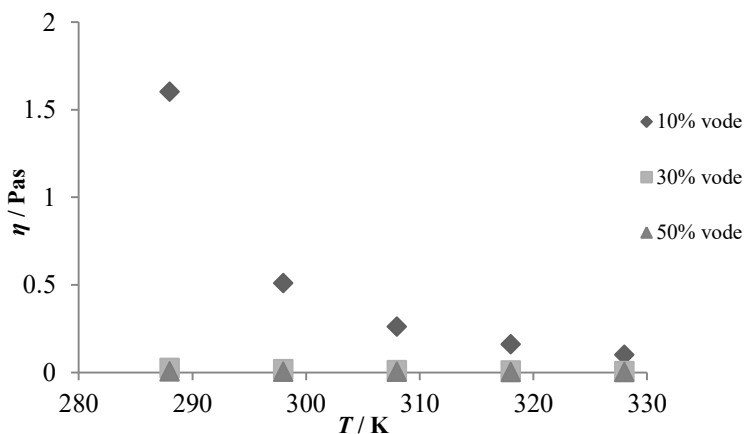

Slika 2. Viskoznost eutektičke smjese CH-Ma sa različitim udjelima vode u ovisnosti o temperaturi
Fig. 2. Temperature function of viscosity of eutectic solvent CH-Ma with different fraction of water

Pri višim temperaturama dolazi do povećanja kinetičke energije i veće pokretljivosti molekula te se molekule mogu bolje opirati snažnim kohezivnih molekulskim silama. Viskoznost eutektičkih otapala osim o sadržaju vode i temperaturi ovisi i o kemijskoj prirodi komponenata tj. o vrsti soli, donoru vodikove veze te jakosti veze kojom se oni povezuju (Yusof i sur., 2014). Među ispitivanim otapalima, najveću viskoznost pokazuje eutektička smjesa pripravljena od betaina i jabučne kiseline (B-Ma). Ovaj rezultat je u skladu sa teorijom Yusofa i sur. prema kojoj je struktura HBD važan faktor u definiranju gustoće i viskoznosti. Naime, kad se broj ugljikovih atoma u lancu povećava, viskoznost se također povećava, a gustoća eutektičke smjese smanjuje. Da bi se mogla izračunati viskoznost u ovisnosti s temperaturom ili udjelom vode, eksperimentalno dobivene viskoznosti korelirane su Arrheniusovim (1) i Vogel-Fulcher-Tamman (VFT) (2) modelom.

$$\eta = \eta_0 \cdot e^{E/RT} \quad (1)$$

$$\ln \eta = A + \frac{B}{T - T_0} \quad (2)$$

U Arrheniusovom modelu (1) η je dinamička viskoznost, η_0 konstanta, E je Arrheniusova energija aktivacije, R je konstanta idealnog plina i T je temperature u kelvinima. U VFT modelu (2) $\ln \eta$ logaritam dinamičke viskoznosti, T je temperature u kelvinima, a A , B , i T_0 su eksperimentalne konstante. U Tablici 2. prikazane su vrijednosti parametara Arrheniusovog i VFT modela. Za sva ispitana eutektička otapala VFT model bolje opisuje promjenu viskoznosti s temperaturom.

Tablica 2. Vrijednosti parametara VFT i Arrhenius modela za ispitane DES-ove

Table 2. Parameters values of VFT and Arrhenius model for investigated DESs

DES	$w_{H_2O}/$ mas%	VFT				ARRH		
		A	$B / *10^4$	T_0 / K	$\sum(\ln \eta - \ln \eta_{VFT})^2$	$E / *10^4$	$\eta_0 / Pa \cdot s$	$\sum(\ln \eta - \ln \eta_{ARRH})^2$
B-Ma	10	39,87	1,68	747,62	$4,90 \cdot 10^{-3}$	3,79	$2,11 \cdot 10^{-6}$	7,88
	30	36,17	3,62	1220,98	$3,86 \cdot 10^{-2}$	3,19	$1,14 \cdot 10^{-1}$	$1,14 \cdot 10^{-4}$
	50	25,97	3,59	1457,44	$3,81 \cdot 10^{-2}$	1,57	$1,05 \cdot 10^{-5}$	$4,85 \cdot 10^{-6}$
Ma-Glu-Gly	10	25,96	1,02	677,29	$1,01 \cdot 10^{-1}$	2,94	$2,88 \cdot 10^{-6}$	$1,07 \cdot 10^{-1}$
	30	22,27	1,39	847,46	$2,30 \cdot 10^{-2}$	2,20	$6,36 \cdot 10^{-6}$	$4,91 \cdot 10^{-4}$
	50	19,04	1,92	1102,04	$7,47 \cdot 10^{-3}$	2,05	$1,87 \cdot 10^{-6}$	$9,28 \cdot 10^{-7}$
CH-Ma	10	31,63	1,43	742,83	$2,39 \cdot 10^{-1}$	5,32	$3,09 \cdot 10^{-10}$	$1,13 \cdot 10^{-1}$
	30	24,87	2,77	1259,14	$1,27 \cdot 10^{-2}$	1,70	$1,90 \cdot 10^{-5}$	$1,99 \cdot 10^{-5}$
	50	22,02	3,21	1467,5	$8,17 \cdot 10^{-3}$	1,30	$2,40 \cdot 10^{-5}$	$8,44 \cdot 10^{-7}$
B-Cit	10	38,59	1,41	671,74	$4,80 \cdot 10^{-1}$	3,46	$2,94 \cdot 10^{-6}$	14,35
	30	31,32	2,74	1098,24	$4,53 \cdot 10^{-2}$	2,89	$5,00 \cdot 10^{-7}$	$1,99 \cdot 10^{-4}$
	50	27,07	3,42	1358,99	$3,65 \cdot 10^{-3}$	2,04	$1,62 \cdot 10^{-6}$	$4,25 \cdot 10^{-7}$
CH-Pro-Ma	10	37,47	1,68	747,68	$3,87 \cdot 10^{-1}$	3,55	$9,05 \cdot 10^{-7}$	2,13
	30	28,16	3,19	1278,92	$1,02 \cdot 10^{-2}$	2,15	$2,09 \cdot 10^{-6}$	$4,73 \cdot 10^{-6}$
	50	26,82	3,80	1462,83	$2,02 \cdot 10^{-2}$	2,00	$9,05 \cdot 10^{-7}$	$2,71 \cdot 10^{-7}$
Pro-Ma	10	36,64	1,69	759,76	$1,66 \cdot 10^{-2}$	3,51	$8,79 \cdot 10^{-7}$	$4,06 \cdot 10^{-1}$
	30	26,40	2,72	1186,58	$1,78 \cdot 10^{-2}$	2,10	$3,08 \cdot 10^{-6}$	$1,26 \cdot 10^{-5}$
	50	22,18	2,98	1371,71	$2,22 \cdot 10^{-2}$	1,44	$1,07 \cdot 10^{-5}$	$7,01 \cdot 10^{-7}$

Kemijsko i biokemijsko inženjerstvo / Chemical and Biochemical Engineering

Indeks loma

Pomoću indeksa loma može se brzo i jednostavno odrediti sadržaj vode u otapalu uz poznavanje baždarnog dijagrama za dano otapalo. Općenito se indeks loma može koristiti za identifikaciju tvari te određivanje njihove čistoće odnosno koncentracije. Za sve ispitane eutektičke smjese indeks loma linearno opada sa povećanjem sadržaja vode. Sadržaj vode u eutektičkim otapalima ima velik utjecaj na smanjenje indeksa loma, zbog znatno manje vrijednost indeksa loma same vode. Vrijednosti indeksa loma eutektičkih otapala osim sa sadržajem vode smanjuju se i s povećanjem temperature. Zbog više temperature dolazi do povećanja kinetičke energije u sustavu i slobodnog prostora između molekula što doprinosi smanjenju indeksa loma. U tablici 3. prikazani su indeksi loma svih eutektičkih smjesa pri različitom sadržaju vode i temperaturi. Pri sobnoj temperaturi najveća vrijednost indeksa loma 1,4786 izmjerena je za eutektičku smjesu CH-Pro-Ma sa 10% vode, a najmanji indeks loma 1,3947 izmjeren je za eutektičku smjesu Ma-Glu sa 50% vode. Najveća standardna devijacija viskoznosti za sve izmjerene eutektičke smjese iznosi $\pm 0,0003$.

pH vrijednost i električna vodljivost

pH vrijednost je fizikalno svojstvo značajno pri odabiru opreme i konstrukcijskih materijala u svim kemijskim postupcima. pH vrijednost eutektičkih otapala pokazuje linearnu ovisnost s promjenom temperature. Kiselost ili bazičnost eutektičkih otapala ovisi o prirodi soli, odnosno donoru vodikove veze. Ovisnost pH vrijednosti o temperaturi ne prati nikakav određeni trend, može se uočiti blago rastući ili blago padajući trend, no niti za jednu eutektičku smjesu nije uočena znatna promjena pH unutar ispitivanog temperaturnog raspona. Slika 3. prikazuje promjenu pH vrijednosti sa sadržajem vode za različita eutektička otapala pri 298 K.

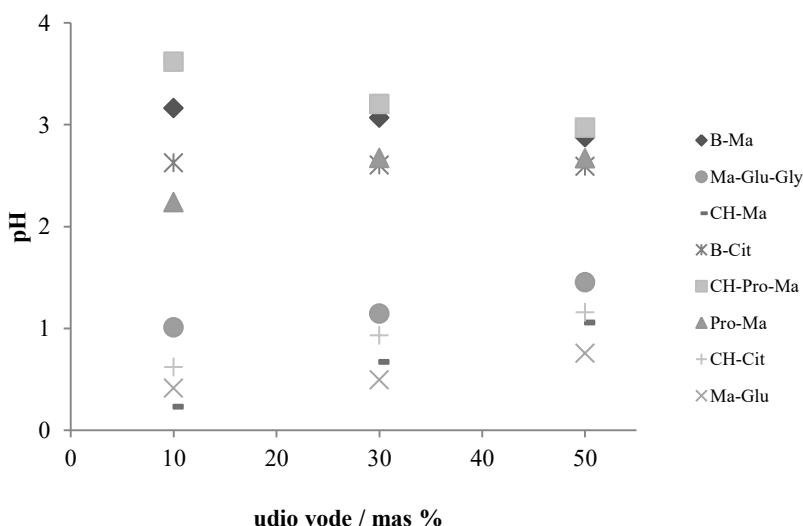

Slika 3. pH vrijednosti DES-ova u ovisnosti o udjelu vode pri 298 K
Fig. 3. pH values of DESs as function of the mass fraction of water at 298 K

Kod eutektičkih otapala s izrazito niskim vrijednostima pH (<1) vidljiv je rast pH s povećanjem udjela vode, dok se kod eutektičkih otapala čiji je pH viši (≈ 3), pH smanjuje s povećanim udjelom vode. Neka ispitana eutektička otapala imaju izrazito niski pH kao što su CH-Ma i CH-Cit (tablica 4.), a kod neki se vrijednost pH dodatno snižava povećanjem temperature (Ma-Glu-Gly) pa se takve eutektičke smjese ne mogu uvijek koristiti te treba voditi računa pri odabiru materijala i opreme kako bi se izbjegle neželjene oksidacije i korodiranje materijala.

Tablica 3. Indeksi loma eutektičkih otapala u temperaturnom području 288-328 K

Table 3. Refractive indices of eutectic solvents in the temperature range 288-328 K

DES	T / K	Indeks loma			DES	T / K	Indeks loma		
		10 mas %	30 mas %	50 mas %			10 mas %	30 mas %	50 mas %
B-Ma	288	1,4756	1,4425	1,4067	B-Cit	288	1,4630	1,4369	1,3951
	298	1,4734	1,4403	1,4049		298	1,4651	1,4350	1,3941
	308	1,4714	1,3885	1,4029		308	1,4599	1,4343	1,3923
	318	1,4698	1,4369	1,4016		318	1,4580	1,4309	1,3906
	328	1,4679	1,4374	1,4001		328	1,4560	1,4280	1,3888
Ma-Glu-Gly	288	1,4782	1,4433	1,4065	CH-Pro-Ma	288	1,4817	1,4401	1,4034
	298	1,4769	1,4428	1,4049		298	1,4806	1,4391	1,4011
	308	1,4749	1,4402	1,4032		308	1,4786	1,4373	1,4000
	318	1,4729	1,4391	1,4023		318	1,4776	1,4366	1,3981
	328	1,4705	1,4388	1,4003		328	1,4755	1,4343	1,3978
CH-Cit	288	1,4762	1,4413	1,4102	Pro-Ma	288	1,4801	1,4351	1,3969
	298	1,4742	1,4395	1,4089		298	1,4781	1,4339	1,3947
	308	1,4724	1,4378	1,4069		308	1,4768	1,4320	1,3931
	318	1,4708	1,4361	1,4054		318	1,4757	1,4306	1,3928
	328	1,4681	1,4344	1,4039		328	1,4736	1,4300	1,3900
CH-Ma	288	1,4749	1,4398	1,4068	Ma-Glu	288	1,4590	1,4473	1,4398
	298	1,4730	1,4376	1,4048		298	1,4570	1,4452	1,4380
	308	1,4712	1,4359	1,4031		308	1,4549	1,4433	1,4352
	318	1,4698	1,4339	1,4014		318	1,4519	1,4416	1,4367
	328	1,4680	1,4320	1,3994		328	1,4509	1,4404	1,4336

Kemijsko i biokemijsko inženjerstvo / Chemical and Biochemical Engineering

Tablica 4. pH vrijednosti i električna vodljivost eutektičkih otapala za različite udjele vode u temperaturnom području 288-328 K

Table 4. pH values and conductivity of eutectic solvents for different fraction of water in temperature range 288-328 K

DES	T / K	pH vrijednost			$\kappa / \text{S m}^{-1}$		
		10 mas%	30 mas%	50 mas%	10 mas%	30 mas%	50 mas%
B-Ma	288	3,39	3,40	2,95	0,028	0,088	0,326
	298	3,16	3,07	2,88	0,085	0,145	0,474
	308	2,98	3,20	2,76	0,204	0,228	0,637
	318	2,83	3,01	2,61	0,337	0,329	0,835
	328	2,62	2,90	2,50	0,617	0,430	1,049
Ma-Glu-Gly	288	1,38	1,30	1,65	0,002	0,016	0,108
	298	1,01	1,15	1,45	0,005	0,025	0,143
	308	0,75	0,97	1,28	0,013	0,034	0,179
	318	0,58	0,82	1,13	0,033	0,046	0,214
	328	0,37	0,67	0,98	0,070	0,065	0,248
CH-Cit	288	0,63	0,88	1,11	0,154	2,170	5,160
	298	0,62	0,93	1,16	0,204	2,390	5,330
	308	0,62	0,96	1,18	0,262	2,600	5,470
	318	0,65	0,97	1,19	0,339	2,780	5,560
	328	0,67	0,98	1,18	0,433	2,930	5,570
CH-Ma	288	0,22	0,55	1,10	0,041	1,704	4,480
	298	0,23	0,67	1,06	0,052	1,921	4,630
	308	0,27	0,75	1,10	0,074	2,110	4,760
	318	0,31	0,77	1,11	0,088	2,250	4,860
	328	0,34	0,78	1,11	0,106	2,341	4,930
B-Cit	288	2,81	2,77	2,75	0,006	0,132	0,385
	298	2,63	2,60	2,59	0,016	0,218	0,540
	308	2,46	2,44	2,44	0,043	0,369	0,709
	318	2,29	2,30	2,26	0,123	0,581	1,006
	328	2,15	2,15	2,12	0,312	0,757	1,315
CH-Pro-Ma	288	3,63	3,35	2,95	0,094	1,252	2,610
	298	3,62	3,21	2,97	0,132	1,771	2,780
	308	3,65	3,08	2,99	0,187	2,400	2,930
	318	3,63	2,95	3,02	0,248	3,140	3,030
	328	3,58	2,80	3,03	0,307	3,980	3,090
Pro-Ma	288	2,17	2,87	2,86	0,015	0,277	0,527
	298	2,24	2,67	2,67	0,038	0,429	0,732
	308	2,23	2,57	2,56	0,072	0,606	0,952
	318	2,22	2,42	2,42	1,027	0,828	1,191
	328	2,19	2,29	2,28	1,093	1,056	1,459
Ma-Glu	288	0,37	0,45	0,76	0,002	0,007	0,043
	298	0,41	0,49	0,76	0,003	0,014	0,046
	308	0,46	0,55	0,77	0,003	0,017	0,053
	318	0,46	0,68	0,79	0,005	0,022	0,060
	328	0,46	0,67	0,81	0,006	0,025	0,064

Električna vodljivost ovisi o ionima prisutnim u otapalu, njihovoj mobilnosti i valencijama tih iona. Vodljivost je kao i ostala fizikalna svojstva izmjerena pri različitim temperaturama i udjelima vode. Za sve ispitane eutektičke smjese električna vodljivost linearno raste s porastom temperature, a tako i sa povećanjem udjela vode (tablica 4.). Zbog velike viskoznosti većina eutektičkih otapala pokazuje niske vrijednosti električne vodljivosti (manje od $0,2 \text{ S m}^{-1}$ pri sobnoj temperaturi). Sastav eutektičkog otapala, odnosno vrsta soli i donora vodikove veze utječe na viskoznost pa tako i na električnu vodljivost otapala (Klamt i sur., 2010). Može se reći kako električna vodljivost razrijeđenih eutektičkih smjesa poprima veće vrijednosti s povišenjem temperature jer se kinetička energija u sustavu povećava što dovodi do povećanja električne vodljivosti i kako je već spomenuto do smanjenja viskoznosti. Eutektičke smjese pripremljene s kolin kloridom (CH-Cit, CH-Ma i CH-Pro-Ma) pokazuju veću ovisnost o sadržaju vode. Vodljivost otapala CHCit sa 50% vode dosegne vrijednost od $5,57 \text{ S m}^{-1}$, a može se primijetiti kako ta eutektička otapala imaju izrazito niske vrijednosti pH. Međutim, vodljivost eutektičkih smjesa pripremljenih od glukoze (Ma-Glu-Gly i Ma-Glu) se nije značajno promijenila s povećanjem udjela vode ($0,002\text{-}0,248$ i $0,002\text{-}0,064 \text{ S m}^{-1}$), a pH vrijednost Ma-Glu je izrazito niska ($\text{pH} < 1$). Umjerene vrijednosti električne vodljivosti otapala rezultat su smanjene pokretljivosti iona zbog većih iona ili zbog njihovog uparivanja i slaganja u nakupine koje onda dovode do smanjenja raspoloživih nositelja naboja (Maugeri i sur., 2014).

Zaključci

U ovom je radu pripravljeno osam prirodnih niskotemperaturnih eutektičkih otapala, te su im eksperimentalno određena sljedeća fizikalna svojstva: gustoća, viskoznost, električna vodljivost, pH vrijednost i indeks loma. Sastav eutektičkog otapala, odnosno vrsta soli i donora vodikove veze utječu na njegova fizikalna svojstva. Gustoća, viskoznost i indeks loma, opadaju s porastom temperature i udjelom vode, dok je suprotan efekt uočen kod električne vodljivosti. Temperatura ne utječe znatno na pH. Međutim, uočeno je da kiselost otapala utječe na ovisnost udjela vode o pH, tako da za otapala čiji je $\text{pH} < 1$, pH raste s povećanjem udjela vode, dok se kod eutektičkih smjesa čiji je pH viši (≈ 3), pH smanjuje s povećanjem udjela vode. Ovisnost viskoznosti o temperaturi uspješno je opisan Vogel-Fulcher-Tamman modelom.

Literatura

- Abbott A. P., Capper G., Davies D. L., Rasheed R. K., Tambyrajah V. (2003): Novel solvent properties of choline chloride/urea mixtures, *Chem. Commun.* 1, 70–71.
- Dai, Y., van Spronsen, J., Witkamp, G. J., Verpoorte, R., Choi, Y. H. (2013): Natural Deep Eutectic Solvents as New Potential Media for Green Technology, *Anal. Chim. Act.* 766, 61–68.
- Gano, Z. S., Mjalli, F. S., Al-Wahaibi, T., Al-Wahaibi, Y., AlNashef, I. M. (2015): Extractive desulfurization of liquid fuel with FeCl_3 -based deep eutectic solvents: Experimental design and optimization by central-composite design, *J. Chem. Eng. Pro.*, 93, 10-20.
- Gore, S., Baskaran, S., Koenig, B. (2011): Efficient synthesis of 3,4-dihydropyrimidin-2-ones in low melting tartaric acid–urea mixtures, *Green Chem.* 13, 1009-1013.

Kemijsko i biokemijsko inženjerstvo / Chemical and Biochemical Engineering

- Jhong, H. R., Wong, D. S. H., Wan, C. C., Wang, Y. Y., Wei, T. C. (2009): A novel deep eutectic solvent-based ionic liquid used as electrolyte for dye-sensitized solar cells, *Electrochem. Commun.* 11, 209-211.
- Klamt A., Eckert F., Arlt W. (2010): COSMO-RS: an alternative to simulation for calculating thermodynamic properties of liquid mixtures. *Annu. Rev. Chem. Biomol. Eng.*, 1, 101-122.
- Oliveira, F. S., Pereiro, A. B., Rebelo, L. P. N., Marrucho, I. M. (2013): Deep eutectic solvents as extraction media for azeotropic mixtures, *Green Chem.* 15, 1326-1330.
- Yusof, R., Abdulmalek, E., Sirat, K., Rahman, M. B. A. (2014): Tetrabutylammonium bromide (TBABr)-based deep eutectic solvents (DESs) and their physical properties, *Molecules*, 19, 8011-8026.
- Zaira Maugeri, Deep Eutectic Solvents: Properties And Biocatalytic Applications, Disertation, Fakultät für Mathematik, Informatik und Naturwissenschaften der RWTH Aachen, 2014.
- Zhang, Q., Zhang, S., Deng, Y. (2011): Recent advances in ionic liquid catalysis, *Green Chem.*, 13, 2619–2637.

Original research paper

Physical properties of natural deep eutectic solvents

Anamarija Mitar¹, Jasna Prlić Kardum^{1*}, Aleksandra Sander¹,
Ivana Radojčić Redovniković²

¹*University of Zagreb, Faculty of Chemical Engineering and Technology,
Marulićev trg 20, 10000 Zagreb, Croatia*

²*University of Zagreb, Faculty of Food Technology and Biotechnology,
Pierottijeva 6, 10000 Zagreb, Croatia*

**Corresponding author: jprlic@fkit.hr*

Summary

Selection of appropriate solvents in industrial processes is a demanding process since the use of conventional, volatile and flammable organic solvents may cause risk to human health, the environment, or the problem with their disposal. For this reason, research and application of natural deep eutectic mixture in different processes, represents an important step to reduce the negative influence of usage of organic solvents. Besides environmental health and safety advantages natural deep eutectic solvents are prepared from cheap, nontoxic and easily available raw materials and have infinite possibilities of combining donors and acceptors of hydrogen bonds. Research on these solvents is on the beginning and data about their physical properties is still insufficient. Since their inchoate application in industry and infinite possibilities of combining donors and acceptors of hydrogen bonds, data of their physical properties are still missing. In this study, density, viscosity, electrical conductivity, refractive indices and pH values of eight prepared natural deep eutectic solvents were determined as functions of temperature from 288 to 328 K. The influence of water content on mentioned physical properties was also defined. Prepared eutectic mixtures show Newtonian's behaviour, whose relative density ranging from 1130 to 1500 kg m⁻³ depending on the added content of water. The decreasing trends in the values of viscosities and refractive indices with increasing temperatures and water content were observed, while the electrical conductivity shows the opposite trend. The dependence of the refractive index, pH and electrical conductivity with temperature change is linear. The change in viscosity with temperature is described Arrhenius and Vogel-Fulcher-Tamman equation.

Keywords: deep eutectic solvents, density, electrical conductivity, pH value, refractive index, viscosity.

Izvorni znanstveni rad

Matematičko modeliranje uzgoja morskih mikroalgi

Branka Gotovac², Antonija Kačunić¹, Davor Rušić^{1*}

*Sveučilište u Splitu, ¹Zavod za kemijsko inženjerstvo, ²Katedra za matematiku,
Kemijsko-tehnološki fakultet, R. Boškovića 35, 21000 Split, Hrvatska*

**Dopisni autor: davor.rusic@ktf-split.hr*

Sažetak

Ovaj rad prilog je sustavnom inženjerskom istraživanju u marikulturi s teorijskog motrišta. Tematikom pripada području matematičkog modeliranja biološkog procesa uzgoja morskih mikroalgi. Za biološko-inženjersku znanost od značaja je poznavanje kinetičkih modela. U radu je prezentirana metodologija njihovog razvoja utemeljena na podacima koji su rezultat simulacije.

Polazište su biološke faze: faza indukcije, eksponencijalna faza, faza usporenja rasta, stacionarna faza i faza odumiranja stanica. Procijenjeni su prijelazi jedne faze u drugu (koncentracija i vrijeme) i korelacijsko-regresijskom analizom definirane su analitičke funkcije za svaku od faza. Kinetički modeli faza razvijeni su deriviranjem funkcija. Navedeni slijed je preduvjet iznalaženja integracijskih konstanti. Naime, koncentracija i vrijeme prijelaza postaju početni uvjeti uz diferencijalne jednadžbe dobivene deriviranjem analitičkih funkcija. Njihova rješenja utemeljena na početnim uvjetima u potpunosti matematički definiraju kinetiku faza. S obzirom da je uzgoj algi vremenski kontinuirani biološki proces i da predstavlja "cjelinu", primijenjena je matrična algebra kojom su objedinjene sve matematičke formulacije, a predstavljaju svojevrсни "matematički preslik" fenomena biološkog procesa.

Ključne riječi: uzgoj morskih algi, matematičko modeliranje, kinetički modeli bioloških faza, matrični model.

Uvod

Matematičko modeliranje fenomena bioloških procesa spada u matematičko formuliranje numeričkih rezultata bioloških istraživanja. Ovim se matematički kvantificiraju biološki fenomeni iz kojih je moguće dobiti cjelovitiji uvid te se mogu donijeti možebitni važni zaključci korisni za osnovnu biološku znanost. Stoga je matematičko modeliranje biološkoj znanosti u stanovitoj mjeri doprinos sagledavanju istraživane problematike. Biološki sustavi, ako se žele sagledati s inženjerskog aspekta, nužno zahtijevaju fazu matematičkog modeliranja. Modeliranje procesa najčešće se temelji na običnim ili parcijalnim diferencijalnim jednadžbama sa zadanim početnim ili rubnim uvjetima. Obično se formuliraju iz bilanci tvari i energije. Njihov oblik i uvjeti određeni su fenomenologijom odvijanja sustava koji se istražuje. Istraživani sustav mijenja biološki mehanizam što se očituje na grafičkom prikazu koncentracijske funkcije $c(t) = f(t)$ (Couteau, 1996). Analizom grafa funkcije moguće je zaključiti na postojanje više mehanizama koji se slijedno smjenjuju. Na slici 1. su dane logaritmirane vrijednosti koncentracija ($\log c$). Ovim su dobivene vrijednosti u prihvatljivijoj formi za numeričko čitanje i za opis eksponencijalne faze.

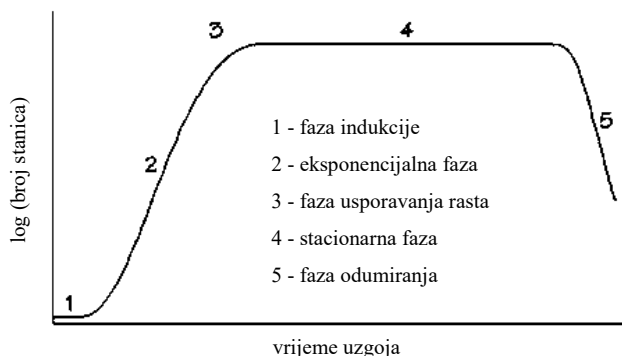

Slika 1. Skica grafa funkcije uzgoja algi (Couteau, 1996)
Fig. 1. Micro-algae cultivation function graph (Couteau, 1996)

Materijali i metode

Razvoj matematičkog modela

U radu se pretpostavilo da se po ovoj shemi vlada mikroalga *dunaliella tertiolecta* koja ima život 3-4 tjedna te da se postiže koncentracija 4000 stanica/ μL . Prema slici 1., simulirani su podaci koncentracija-vrijeme. Prikaz simuliranih podataka dan je na slici 2. Vrijeme, t , je dano u danima, a koncentracija, c , je izražena u broju stanica po μL . Iz grafičkih prikaza uočavaju se dva perioda: faza «života» i faza odumiranja. Matematičkim modeliranjem nije moguće pronaći analitičku funkciju koja bi opisala proces uzgoja u potpunosti. S obzirom da postoji pet uzgojnih faza, očito je da se radi o biološkom procesu koji mijenja svoj uzgojni mehanizam. Stoga se za matematički opis uzgoja predlaže kompleksan model koji uključuje biološke faze uzgoja ponaosob (Dabić i sur., 2000).

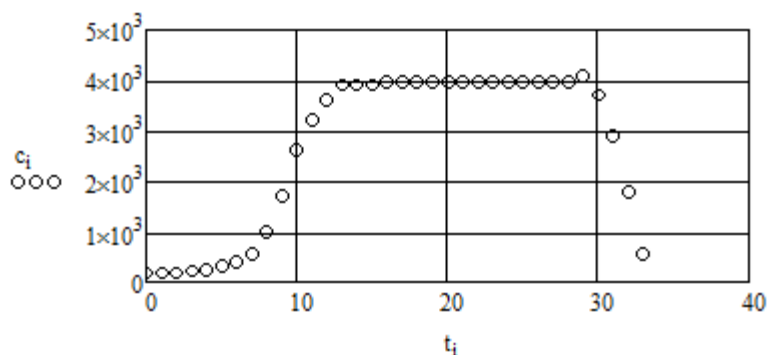

Slika 2. Grafički prikaz simuliranih podataka.
Fig. 2. Graphical representation of simulated data.

Rezultati i rasprava

Logaritmiranjem vrijednosti simuliranih podataka koncentracije sa slike 2., dobivaju se podaci koji grafički slijede iste zakonitosti kao oni ilustrirani na slici 1., a što je i bio primarni cilj simulacije. Grafički prikaz logaritmiranih vrijednosti dat je na slici 3.

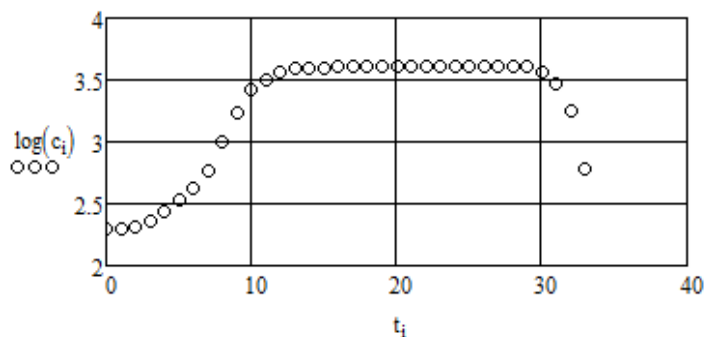

Tablica 2. Funkcije uzgoja i njihove logaritmirane forme.

Table 2. Growth functions and their logarithmic forms.

Uzgojna faza	Koncentracijske funkcije
Indukcijska faza	$200 + j^3$
Eksponencijalna faza	$18.9 \cdot e^{0.5k}$
Faza usporavanja + stacionarna faza	$\frac{4 \cdot 10^3}{1 + 10^4 \cdot e^{-p}}$
Faza odumiranja	$\frac{-2.75 \cdot 10^4}{34.5} \cdot u + 2.75 \cdot 10^4$
Uzgojna faza	Logaritmirane koncentracijske funkcije
Indukcijska faza	$\log(200 + j^3)$
Eksponencijalna faza	$\log(18.9 \cdot e^{0.5k})$
Faza usporavanja + stacionarna faza	$\log\left(\frac{4 \cdot 10^3}{1 + 10^4 \cdot e^{-p}}\right)$
Faza odumiranja	$\log\left(\frac{-2.75 \cdot 10^4}{34.5} \cdot u + 2.75 \cdot 10^4\right)$

Grafički prikazi koncentracijskih funkcija i njihovih logaritamskih formi za pojedine faze dani su na slikama 4. i 5. Iz slike 4. je utvrđena mogućnost posebnog opisa faze usporenja od stacionarne faze. Za ovu fazu bila je korištena funkcija $d(z)=4000$ s područjem definicije $[14,3.9 \cdot 10^3]$. U tom slučaju logistička funkcija koristila bi se samo za fazu usporavanja. Pokazalo se da logistička funkcija bolje opisuje zajedno obje faze zbog čega se predlaže ovaj pristup. Isto je potvrđeno i na logaritmiranim formama koncentracijskih funkcija. Zbog preglednosti, slika 4. i slika 5. su grafički prikazane većim formatom od slike 2. i slike 3., a imaju iste vrijednosti nezavisne i zavisnih varijabli. Iz prikaza podataka na slici 2. procijenjene su točke prijelaza jedne faze u drugu. Koncentracijske funkcije u točki prijelaza imaju istu vrijednost za tu fazu i fazu koja slijedi. Izjednačavanjem vrijednosti tih funkcija računa se vrijeme u kojem dolazi do smjene faza, a time i koncentracija prijelaza jedne faze u drugu. Rezultati izračuna dani su u tablici 3. Na temelju simuliranih podataka prikazanih na slici 2. te podataka navedenima u tablicama 1. do 3., stvoreni su preduvjeti razvoja složenog kinetičkog modela uzgoja.

Za cjelovitiji uvid u kinetiku uzgoja još je jedan fenomen kinetičkog procesa važan. Pažljivom analizom sheme na slici 1. uočeno je postojanje već spomenute točke infleksije. Do ove točke koncentracijska funkcija je konkavna nakon čega mijenja zakrivljenost.

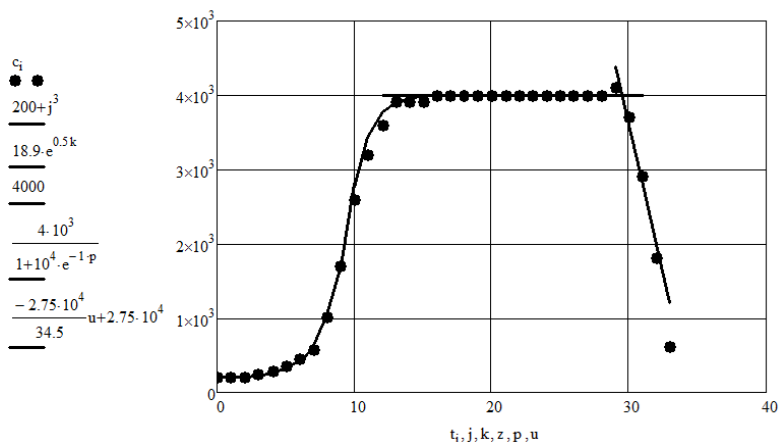

Slika 4. Grafički prikaz koncentracijskih funkcija za pojedine faze
Fig. 4. Graphical representation of concentration functions for different cultivation phases

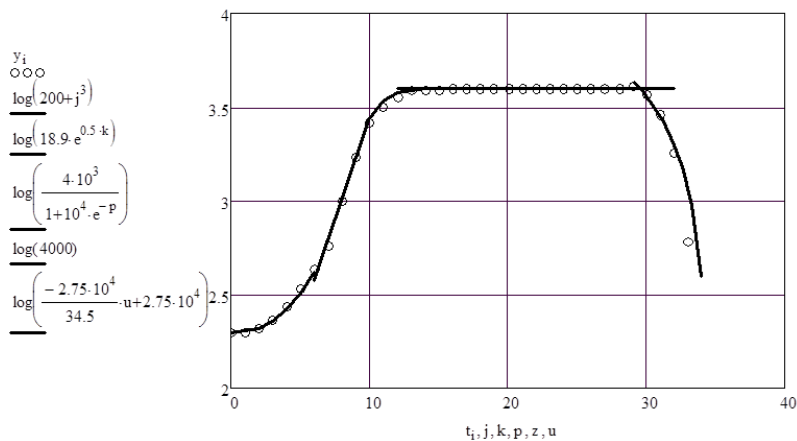

Slika 5. Grafički prikaz logaritamske forme koncentracijskih funkcija za pojedine faze
Fig. 5. Graphical representation of logarithmic form of concentration functions for different cultivation phases

Pored rasta koncentracije algi, evidentno je da je i rast ubrzan, pa vrijedi $d(dc/dt)/dt > 0$. Od točke infleksije koncentracija i dalje raste, ali usporeno, dakle vrijedi $d(dc/dt)/dt < 0$. Slijedi područje kada se koncentracija ne mijenja. Prethodno iznesenim, stvoreni su preduvjeti za opis kinetičkih fenomena u vremenu «života» mikroalgi. Za napomenuti je da točka infleksije odgovara točki prijelaza iz eksponencijalne faze u fazu usporavanja što je u skladu s biološkim istraživanjem.

Tablica 3. Vrijednosti vremena i koncentracija prijelaza jedne faze u drugu
Table 3. Time and concentration values of phase transitions

Prijelazi faza	c_p	t_p
Indukcijske u eksponencijalnu fazu	462.2	6.385
Eksponencijalne u fazu usporavanja + stacionarnu fazu	$2.751 \cdot 10^3$	9.889
Faze usporavanja + stacionarne faze u fazu odumiranja	$4 \cdot 10^3$	29.482

Kinetički modeli razvijaju se iz koncentracijskih modela danih u tablici 2. Deriviranjem koncentracijskih funkcija dobivaju se obične diferencijalne jednadžbe s početnim uvjetima , navedene u tablici 3. Postupak je ilustriran na ogleđnom primjeru za eksponencijalnu fazu:

$$\frac{d}{dk}(18.9 \cdot e^{0.5k}) = 9.45 \cdot e^{0.5k} \quad (1)$$

tj.

$$\frac{dc}{dk} = 9.45 \cdot e^{0.5k} \quad (2)$$

Početni uvjeti: $k = 6.385$, $c = 462.2$

$$c = \int 9.45 \cdot e^{0.5k} dk \quad (3)$$

$$c = 18.9 \cdot e^{0.5k} + K_2 \quad (4)$$

$$K_2 = c - 18.9 \cdot e^{0.5k} \quad (5)$$

$$K_2 = -3.486 \cdot 10^{-4} \quad (6)$$

Nakon određivanja integracijske konstante, koncentracijska funkcija dobivena iz kinetičkog modela može se zapisati kao:

$$c = 18.9 \cdot e^{0.5k} - 3.486 \cdot 10^{-4} \quad (7)$$

Analogno gornjem postupku, dobiju se i ostale funkcije. Iz tablice 4. proizlaze kinetičke zakonitosti navedene u tablici 5. Grafički prikaz kinetičkog modela uzgoja dan je na slici 6. Funkcija uzgoja složena je od četiri funkcije čije su dodirne točke ujedno i prijelazi faza. S obzirom na to da je faza usporavanja rasta i stacionarna faza opisana logističkom funkcijom, tri su točke prijelaza. Ovakvo formulirana funkcija uzgoja omogućava kontinuirani tok kinetičke funkcije. Razlog tome je okoliš točke prijelaza koncentracijske faze u fazu koja slijedi, a gdje su promjene koncentracije manje ili više značajno izražene.

Kemijsko i biokemijsko inženjerstvo / Chemical and Biochemical Engineering

Tablica 4. Pregled važnijih elemenata postupka izvođenja koncentracijskih funkcija iz kinetičkih modela

Table 4. Overview of the important steps in obtaining the concentration functions from kinetic models

Uzgojne faze	Derivacije koncentracijskih funkcija dobivenih iz korelacijsko-regresijske analize	Vremena prijelaza i integracijske konstante
Indukcijska faza	$\frac{d}{dj}(200 + j^3)$	$j = 0$ $K_1 = 200$
Eksponecijalna faza	$\frac{d}{dk}(18.9 \cdot e^{0.5k})$	$k = 6.385$ $K_2 = -3.486 \cdot 10^{-4}$
Faza usporavanja + stacionarna faza	$\frac{d}{dp}\left(\frac{4 \cdot 10^3}{1 + 10^4 \cdot e^{-p}}\right)$	$p = 9.889$ $K_3 = 1.886 \cdot 10^3$
Faza odumiranja	$\frac{d}{du}\left(\frac{-2.75 \cdot 10^4}{34.5} \cdot u + 2.75 \cdot 10^4\right)$	$u = 29.482$ $K_4 = 2.75 \cdot 10^4$

Tablica 5. Kinetički modeli i iz njih izvedene koncentracijske funkcije

Table 5. Kinetic models and concentration functions derived from them

Uzgojne faze	Oznake za kinetičke modele	Kinetički modeli	Koncentracijske funkcije dobivene iz kinetičkih modela
Indukcijska faza	$d_1(j)$	$3j^2$	$200 + j^3$
Eksponecijalna faza	$d_2(k)$	$9.45 \cdot e^{0.5k}$	$18.9 \cdot e^{0.5k} - 3.486 \cdot 10^{-4}$
Faza usporavanja + stacionarna faza	$d_3(p)$	$\frac{4 \cdot 10^7 \cdot e^{-p}}{(1 + 10^4 \cdot e^{-p})^2}$	$\frac{4 \cdot 10^3}{1 + 10^4 \cdot e^{-p}} + 1.886 \cdot 10^3$
Faza odumiranja	$d_4(u)$	-797.101	$\frac{-2.75 \cdot 10^4}{34.5} \cdot u + 2.75 \cdot 10^4$

U nastavku su podaci uzeti iz tablice 3. i slike 4. Naime, za prijelaz koncentracijske funkcije iz indukcijske faze u eksponencijalnu funkciju vrijedi:

$$\lim_{\Delta j \rightarrow 0} \frac{\Delta(j^3 + 200)}{\Delta j} \cong \lim_{\Delta k \rightarrow 0} \frac{\Delta(18.9 \cdot e^{0.5k})}{\Delta k} \quad (8)$$

pa je prijelaz kinetičkih funkcija približno kontinuiran. U točki infleksije granične vrijednosti mijenjaju predznak, tj.

$$\lim_{\Delta k \rightarrow 0} \frac{\Delta(18.9 \cdot e^{0.5k})}{\Delta k} > 0 \quad (9)$$

$$\lim_{\Delta p \rightarrow 0} \frac{4 \cdot 10^3}{1 + 10^4 \cdot e^{-p}} < 0 \quad (10)$$

Zbog ovog kinetička funkcija ima u točki infleksije maximum. Na prijelazu stacionarne faze u fazu odumiranja, drastična je promjena graničnih vrijednosti:

$$\lim_{\Delta p \rightarrow 0} \frac{4 \cdot 10^3}{1 + 10^4 \cdot e^{-p}} \gg \lim_{\Delta u \rightarrow 0} \left(\frac{-2.75 \cdot 10^4}{3.45} \cdot u + 2.75 \cdot 10^4 \right) \quad (11)$$

što se vidi iz kinetičke funkcije. Iz tog razloga je kinetička funkcija za odumiranje algi u negativnom području. Gore izneseno je razlog prekida na grafičkoj prezentaciji kinetike ciklusa uzgoja. Potrebno je istaknuti da je logističkom funkcijom moguće opisati i fazu odumiranja što je prikazano na slici 5. Ovim bi bile obuhvaćene tri faze. S obzirom da se u radu želi dati matematički algoritam za procese koji mijenjaju mehanizme, ovome nije u radu dat značaj. Isto tako mala promjena vrijednosti parametara značajno djeluje na vrijednost logističke funkcije. Dakle, ova funkcija bi bila gruba aproksimacija. Zbog toga je korištena u području od početka eksponencijalne do kraja stacionarne faze te nije uključena u formuliranje kinetičkog modela na slici 6.

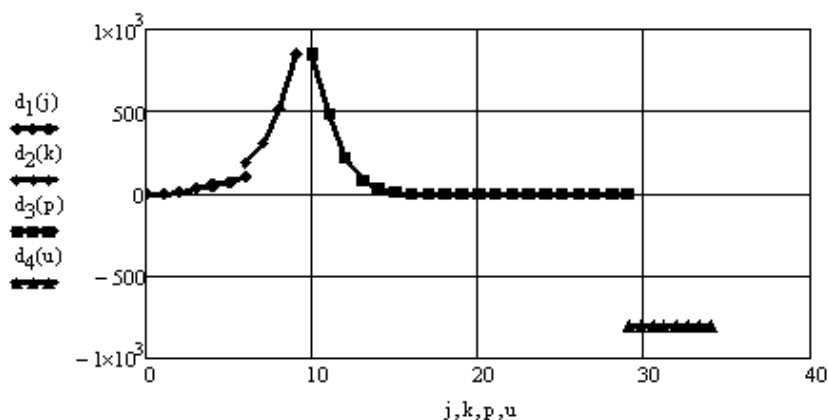

Slika 6. Grafički prikaz kinetičkog modela uzgoja algi
Figure 6. Graphical representation of kinetic model of algae cultivation

Verifikacija koncentracijskog modela

Uvid u točnost kinetičkog modela verificira se usporedbom empirijskih funkcija dobivenih korelacijsko-regresijskom analizom (slika 4.) i koncentracijskih funkcija dobivenih integracijom diferencijalnih jednadžbi (tablica 5., slika 7.). sa simuliranim podacima.

Matrični opis

Matrični opis odnosi se na matrično modeliranje u trenutku kad je uzgojni ciklus završen, tj. kad je prošao sve uzgojne faze. Modeliranje se temelji na definiranju matrica u kojima su zapisani matematički modeli svake od uzgojnih faza. U tom smislu prišlo se na dva načina.

U prvom, za pet uzgojnih faza, odnosno četiri, budući su objedinjene faza usporavanja i stacionarna faza, definirane su četiri dijagonalne matrice. Njihov produkt je rezultatna matrica koja na glavnoj dijagonali kao elemente ima matematičke modele za svaku od faza.

Kemijsko i biokemijsko inženjerstvo / Chemical and Biochemical Engineering

Ukoliko se produktu dijagonalnih matrica pridruže parametri modela, matrični model je u potpunosti definiran. Uvid u stanje sustava omogućava rezultatna matrica kojoj su elementi glavne dijagonale numeričke vrijednosti modela. Za verifikaciju modela odabrani su navedeni ulazni podaci. Rezultati modeliranja mogu se usporediti s vrijednostima na slici 4. Dakle, matrični model zadovoljava elementarni algoritam programiranja (unos ulaznih podataka, zakonitost njihove matematičke obrade, izlazni podaci). Kao alternativu predlaže se model koji je temeljen na matričnim vektorima s istim osnovnim algoritmom. Za ilustraciju dat je koncentracijski matrični model. Po istom algoritmu moguće je matrično modelirati logaritamski i kinetički model.

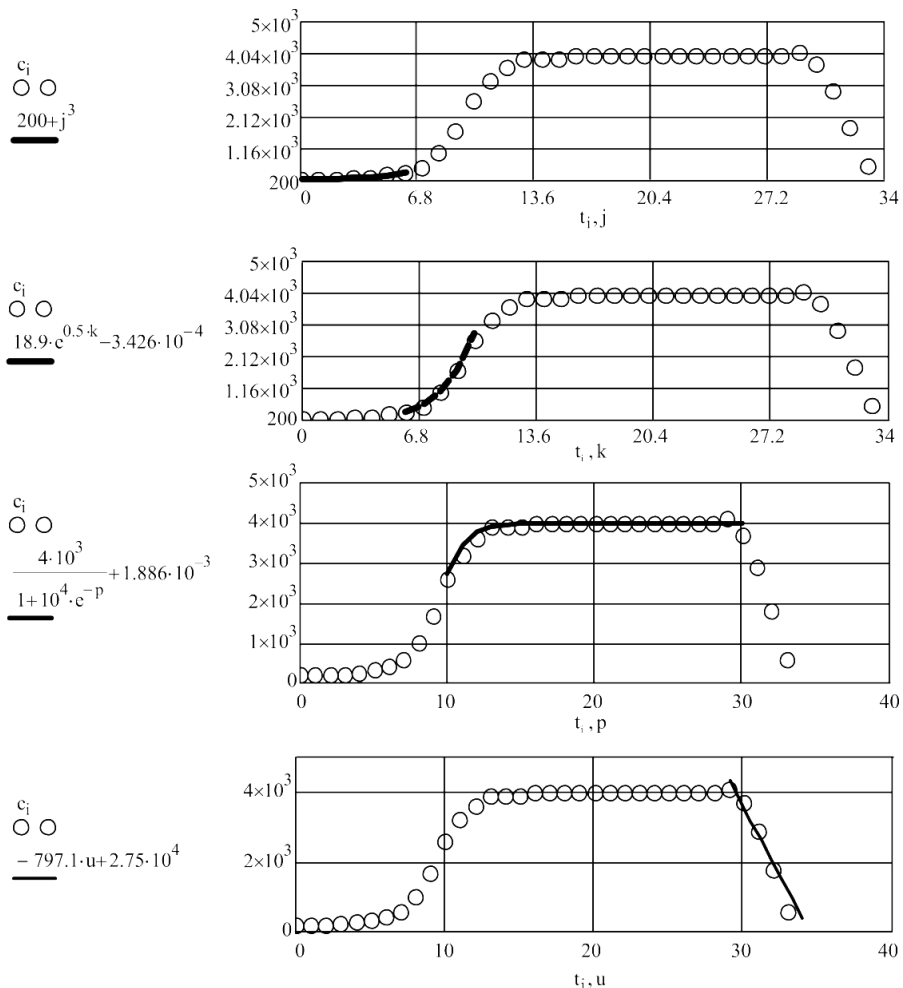

Slika 7. Koncentracijske funkcije faza dobivene rješenjem kinetičkih modela
Fig. 7. Concentration functions obtained by solving the kinetic models

Model razvijen dijagonalnim matricama

Proračun je preuzet iz korištenog alata (Mathcad).

Ulazni podaci: $j:=5$, $k:=7$, $p:=15$, $u:=32$.

U proračun je uzeto 5 parametara iz tablice 2. prethodnom redukcijom parametara.

$$i := 1.5$$

$$C_i := \begin{matrix} 200 \\ 0.5 \\ 18.9 \\ 4000 \\ -797.101 \end{matrix}$$

$$\begin{pmatrix} j^3 + C_1 & 0 & 0 & 0 \\ 0 & 1 & 0 & 0 \\ 0 & 0 & 1 & 0 \\ 0 & 0 & 0 & 1 \end{pmatrix} \cdot \begin{pmatrix} 1 & 0 & 0 & 0 \\ 0 & C_3 \cdot e^{C_2 \cdot k} & 0 & 0 \\ 0 & 0 & 1 & 0 \\ 0 & 0 & 0 & 1 \end{pmatrix} \cdot \begin{pmatrix} 1 & 0 & 0 & 0 \\ 0 & 1 & 0 & 0 \\ 0 & 0 & \frac{C_4}{1 + 10^4 \cdot e^{-p}} & 0 \\ 0 & 0 & 0 & 1 \end{pmatrix} \cdot \begin{pmatrix} 1 & 0 & 0 & 0 \\ 0 & 1 & 0 & 0 \\ 0 & 0 & 1 & 0 \\ 0 & 0 & 0 & C_5 \cdot u + 2.75 \cdot 10^4 \end{pmatrix}$$

$$\begin{pmatrix} j^3 + C_1 & 0 & 0 & 0 \\ 0 & C_3 \cdot e^{C_2 \cdot k} & 0 & 0 \\ 0 & 0 & \frac{C_4}{10000 \cdot e^{-p} + 1} & 0 \\ 0 & 0 & 0 & C_5 \cdot u + 2.75 \cdot 10^4 \end{pmatrix} = \begin{pmatrix} 325 & 0 & 0 & 0 \\ 0 & 625.882 & 0 & 0 \\ 0 & 0 & 3.988 \cdot 10^3 & 0 \\ 0 & 0 & 0 & 1.993 \cdot 10^3 \end{pmatrix}$$

Model razvijen matricnim vektorima

U proračun je uzeto svih 7 parametara iz tablice 2.

Ulazni podaci: $j:=5$, $k:=7$, $p:=15$, $u:=32$

$$i := 1.7$$

$$C_i := \begin{matrix} 200 \\ 18.9 \\ 0.5 \\ 4000 \\ 10000 \\ -2.75 \cdot 10^4 \\ 34.5 \\ 2.75 \cdot 10^4 \end{matrix}$$

$$\left(\begin{array}{c} 200 + j^3 \\ 18.9 \cdot e^{0.5k} \\ 4 \cdot 10^3 \\ \frac{1 + 10^4 \cdot e^{-p}}{-2.75 \cdot 10^4} \cdot u + 2.75 \cdot 10^4 \\ 34.5 \end{array} \right)$$
$$\left(\begin{array}{c} j^3 + c_1 \\ e^{k \cdot c_3} \cdot c_2 \\ c_4 \\ \frac{e^{-p} \cdot c_5 + 1}{u \cdot c_6 + c_7} \end{array} \right) = \left(\begin{array}{c} 325 \\ 625.882 \\ 3.988 \cdot 10^3 \\ 1.993 \cdot 10^3 \end{array} \right)$$

Zaključci

U radu je ilustrirana simulacija ciklusa uzgoja algi na temelju koje je razvijen matematički model. Radi se o funkciji uzgoja koja je složena od više funkcija određenih fenomenima bioloških faza. Osnova su empirijske funkcije koje se slijedno smjenjuju. Za nastavak modeliranja nužno je utvrditi vrijeme i koncentraciju smjene faza. Ove točke postaju početni uvjeti uz diferencijalne jednadžbe čija analitička rješenja daju kinetičke modele. Također, moguće je iz koncentracijskog i kinetičkog modela utvrditi u kojim je vremenima i biološkim fazama proces ubrzan, ili se usporava, ili nema promjene brzine. Koncentracijske funkcije, njihove logaritmirane forme i kinetičke funkcije, ponaosob je moguće izraziti matrično. Promjenom ulaznih podataka sagledava se stanje procesa u bilo kojoj fazi i bilo kojem vremenu u slučaju kad je istražen i numerički opisan ukupan biološki ciklus. S obzirom da se radi o simulaciji, u realnim uvjetima laboratorijskih praćenja procesa ili praćenja procesa u uzgajalištima, funkcije i njihovi parametri moraju biti prilagođeni izmjerenim podacima. Predložena simulacija daje samo jednu od mogućih pristupa matematičkog opisa uzgojnog procesa. Ukoliko se opisuje neki drugi sustav na raspolaganju su druge matrične forme i algebra, ovisno o specifičnim fenomenima sustava koji se istražuje.

Zahvala: Ovaj rad je dio projekta IP-11-2013-8959 HETMIX (2014.-2018.) kojeg financira Hrvatska zaklada za znanost.

Literatura

- Bacci, E., Rušić, D., Svilović S., Žanetić, R. (2011): Modeliranje kinetike reakcijskih sustava koji imaju funkciju s infleksijom. In: Zbornik radova 13. Ružičkini dani: Danas znanost-sutra industrija, Šubarić, Drago (ur.), Vukovar, HR, str. 126-136.
- Couteau, P. (1996): Micro alge. In: Manual on the production and use of live food for aquaculture, Lavens, P., Sorgeloos, P. (ur.), FAO, Rome, str. 7-48.
- Dabić, P., Krstulović, R., Rušić, D. (2000): A new approach in mathematical modelling of cement hydration development, *Cem. Concr. Res.* 30, 1017-1021.

Original research paper

Mathematical modeling of marine micro-algae cultivation

Branka Gotovac², Antonija Kačunić¹, Davor Rušić^{1*}

*University of Split, ¹ Department of Chemical Engineering, ² Chair of Mathematics,
Faculty of Chemistry and Technology, R. Boškovića 35, 21000 Split, Croatia*

**Corresponding author: davor.rusic@ktf-split.hr*

Summary

This paper presents a contribution to the systematic engineering research in mariculture from a theoretical point of view. The theme itself belongs to the field of mathematical modeling of biological processes of growing marine microalgae. Knowledge of the kinetic model is imperative when it comes to bio-engineering sciences. Thus, this paper presents a methodology on model development based on simulated data.

The starting point for the development of the model are biological phases: induction phase, exponential phase, phase of declining relative growth, stationary phase and the phase of cell death. Transitions between the phases are estimated (both concentration and time) and analytic functions for each phase were defined by correlation-regression analysis. Kinetic models have been developed by derivation of the mentioned analytic functions. This way it is possible to determine the integration constants. Concentration and time represent the initial conditions with differential equations obtained by deriving the analytic functions. Solutions based on those initial conditions mathematically define the phase kinetics completely. Considering that the algae cultivation is a continuous biological process which can be considered as a whole, matrix algebra was applied by which all of the mathematical formulations were combined thus representing a "mathematical image" of the biological process phenomenon.

Keywords: micro-algae cultivation, mathematical modelling, kinetic models of biological process, matrix model

Izvorni znanstveni rad

Primjena ionskih kapljevina i eutektičkih otapala u ekstrakcijskoj desulfurizaciji i denitrifikaciji

Kristina Zagajski Kučan, Marko Rogošić, Aleksandra Sander*

*Sveučilište u Zagrebu, Fakultet kemijskog inženjerstva i tehnologije,
Marulićev trg 19, 10000 Zagreb, Hrvatska*

**Dopisni autor: asander@fkit.hr*

Sažetak

U posljednjem se desetljeću može uočiti trend porasta svjetske potrošnje energije, što u prometnom sektoru znači stalan porast potrošnje fosilnih goriva, a time i povećane emisije produkata izgaranja koji nepovoljno utječu na okoliš te su odgovorni za klimatske promjene. Komercijalni industrijski procesi hidrodesulfurizacije i hidrogenitrogenacije ekološki su i energetski nepovoljni, što je dovelo do razvoja alternativnih metoda za dobivanje goriva potrebne kvalitete. Jedna od njih koja se u velikoj mjeri istražuje je ekstrakcija kapljevina-kapljevina. Razvoj i izuzetna svojstva ionskih kapljevina i niskotemperaturnih eutektičkih otapala omogućili su njihovu primjenu u ekstrakciji. Poznavanje fizikalno-kemijskih svojstava i fazne ravnoteže kapljevina-kapljevina omogućava evaluaciju primjenjivosti otapala u procesu ekstrakcije. U ovom su radu eksperimentalno određene fazne ravnoteže kapljevina-kapljevina u kojima su tiofen i piridin prisutni kao ključna komponenta, *n*-heksan kao primarno otapalo te ionske kapljevine, odnosno niskotemperaturna eutektička otapala kao sekundarno otapalo. Na temelju koeficijenata raspodjele i selektivnosti procijenjena je mogućnost primjene tih otapala u procesima separacije sumporovih i dušikovih spojeva iz njihove smjese s *n*-heksanom. Vrijednosti koeficijenata raspodjele veće su za sustave s ionskim kapljevinama, a niskotemperaturna eutektička otapala su selektivnija. Obje vrste ekološki prihvatljivih otapala imaju potencijal za primjenu u procesima desulfurizacije i denitrifikacije motornih goriva.

Ključne riječi: denitrifikacija, desulfurizacija, ekstrakcija kapljevina-kapljevina, niskotemperaturna eutektička otapala, ionske kapljevine

Uvod

Prema definiciji, zelena otapala su otapala koja imaju minimalan negativan utjecaj na okoliš, a koji proizlazi iz upotrebe tih otapala u proizvodnji. Većina industrijskih procesa koristi štetna organska otapala. Da bi takav proces bio ekološki prihvatljiv, potrebno je štetna otapala zamijeniti otapalima s povoljnijim EHS (*environmental, health and safety*) svojstvima, biootapalima, superkritičnim fluidima, ionskim kapljevinama ili niskotemperaturnim eutektičkim smjesama (Capelo i sur., 2007). Ionske su kapljevine organske soli koje su pri sobnoj temperaturi u kapljevitom stanju (Earle i Seddom, 2000). Ionske se kapljevine sastoje od kationa i aniona, te posjeduju visok stupanj nesimetričnosti zbog čega je onemogućena njihova kristalizacija.

Niskotemperaturne eutektičke smjese su smjese donora i akceptora vodikove veze s talištem nižim od tališta pojedinačnih komponenti (Abbott i sur., 2011). Obje vrste otapala posjeduju slična svojstva. Svojstva najznačajnija za njihovu primjenu u separacijskim procesima su: nezapaljivost, zanemariv tlak para, kemijska i toplinska stabilnost te visok kapacitet otapanja različitih vrsta tvari (Freemantle, 1998). Osim toga, relativno ih je jednostavno regenerirati, pa čak i višestruko koristiti bez prethodnog pročišćavanja (Anugwom i sur., 2011, Shu i Sun, 2016). Sposobnost podešavanja svojstava obje vrste otapala jednostavnom zamjenom kationa ili aniona, odnosno donora ili akceptora vodikove veze omogućava im široku primjenu, tako da su našle svoje mjesto i u procesima obrade motornih goriva (Pena-Pereira i Namiešnik, 2014). Sumporovi i dušikovi spojevi prisutni u nafti u velikoj su mjeri odgovorni za smanjenje efikasnosti pojedinih procesa jer zasićuju i truju katalizatore. Benzin i dizelsko gorivo koji sadrže prevelike koncentracije sumporovih, dušikovih i aromatskih spojeva tijekom izgaranja proizvode ispušne plinove koji sadrže znatne koncentracije SO_x, NO_x, CO, CO₂, ugljikovodika te čvrstih čestica te doprinose onečišćenju okoliša (Song, 2003). Sumporovi i dušikovi oksidi odgovorni su za stvaranje smoga, kiselih kiša, čvrstih čestica, smanjenu vidljivost te globalno zatopljenje. Zbog toga je zakonska regulativa orijentirana smanjenju maksimalno dopuštenih koncentracija tih spojeva. Najčešće korišten komercijalni proces desulfurizacije ugljikovodičnih smjesa je hidrodiesulfurizacija (HDS) (Stanislaus i sur., 2010). S obzirom na to da reaktivnost sumporovih spojeva u tom procesu opada s veličinom molekule spoja, a sumporovi spojevi koji zaostaju u benzinu su uglavnom tiofen i njegovi derivati, snižavanje koncentracije sumpora u benzinu veoma je teško provesti komercijalnim procesom (Francisco i sur., 2010). Osim toga, prisutnost dušikovih spojeva u smjesi također snižava učinkovitost HDS (Ravilla i Banerjee, 2004). Naime, afinitet dušikovih spojeva spram katalizatoru je veći, a sama reakcija denitrogenacije je vrlo spora, tako da dušikovi spojevi zasićuju površinu katalizatora. Zbog velike potrošnje energije, vodika i katalizatora, istražuju se različite metode koje bi mogle zamijeniti komercijalni proces HDS (Wilfred i sur., 2012). Jedna od tih metoda je i ekstrakcijska desulfurizacija (EDS). Glavnu prednost EDS čine blagi uvjeti provođenja ekstrakcije (niska temperatura i atmosferski tlak). Ekstrakcija pomoću ionskih kapljevinu u najvećoj je mjeri istraživana u procesu desulfurizacije. Međutim, autori koji su kao pojne smjese koristili modelne otopine koje sadrže sumporove, dušikove i aromatske spojeve te realne rafinerijske uzorke dokazali su da se uz desulfurizaciju istovremeno odvijaju procesi denitrogenacije i dearomatizacije (Ceron i sur., 2012, Casal, 2010, Song, 2003). U novije se vrijeme istražuje i primjena niskotemperaturnih eutektičkih otapala u procesima desulfurizacije (Jing i sur., 2016), denitrogenacije (Hizaddin i sur., 2014) i dearomatizacije (Sander i sur., 2016).

U ovom je radu istražena mogućnost primjene ionskih kapljevinu, [C₅mim][Tf₂N] i [bzmim][Tf₂N], i niskotemperaturnih eutektičkih otapala, [kolin-klorid – glicerol] i [kolin-klorid – urea], u procesima desulfurizacije i denitrogenacije modelne otopine, kao i mogućnost regeneracije otapala vakuumskim isparavanjem. Primjenjivost otapala procijenjena je na temelju eksperimentalno određenih ravnoteža kapljevinu-kapljevinu, odnosno koeficijenata raspodjele i selektivnosti otapala.

Materijali i metode

Materijali

Za uklanjanje tiofena i piridina iz smjese s *n*-heksanom korištena su sljedeća otapala: ionske kapljevine, [C₅mim][Tf₂N] i [bzmim][Tf₂N], te niskotemperaturna eutektička otapala, [kolin-klorid – glicerol] i [kolin-klorid – urea]. Sinteza ionskih kapljevina opisana je u literaturi (Gabrić i sur., 2013). Čistoća ionskih kapljevina određena je ¹H NMR spektroskopijom (Bruker AV300) na Institutu Ruđer Bošković iz Zagreba. Kolin-klorid i glicerol pomiješani su u molnom omjeru 1:2, te je dobivena smjesa miješana u rotacijskom vakuumskom isparivaču pri 60 °C i 250 mbar sve dok se nije dobila bezbojna jednofazna kapljevina. Na sličan je način pripravljeno otapalo [kolin-klorid – urea].

Određivanje binodalne krivulje

Točke na binodalnoj krivulji određene su metodom titracije. U definiranu masu smjese *n*-heksana i piridina ili tiofena poznatog sastava dodavano je otapalo kap po kap do pojave zamućenja. Na analogan je način određena i druga strana binodalne krivulje, titriranjem definirane mase smjese *n*-heksana i otapala poznatog sastava piridinom ili tiofenom. Koncentracije su određene gravimetrijski (vaga: Kern ALJ 220-4 NM preciznosti ± 0,0001 g). Standardne mjerne nesigurnosti računane su prema:

$$u(x_i) = \left[\frac{1}{n \cdot (n+1)} \cdot \sum_{i=1}^n (x_i - x_{i,sr})^2 \right]^{0,5} \quad (1)$$

Određivanje veznih linija

Za određivanje ravnotežnih sastava faza pripravljene su dvofazne trokomponentne smjese definiranog ukupnog sastava. Smjese su miješane 24 sata u termostatiranoj zračnoj kupelji (100 o/min). Nakon separacije ravnotežnih faza izmjereni su indeksi loma rafinatne faze. Mjerenja su provedena tri puta na Abbeovom refraktometru (Model RMI, Exacta Optech, preciznosti ± 0,0001). S obzirom na to da vezna linija prolazi kroz točku sastava pripravljene otopine i sastava rafinatne faze, koncentracije u ekstraktnoj fazi očitane su s binodalne krivulje. Ovisnost indeksa loma o sastavu otopine pri 25 °C dana je sljedećim izrazima:

Piridin – *n*-heksan:

$$w(\text{piridin}) = -18,3864 \cdot n_{D,25}^2 + 60,1960 \cdot n_{D,25} - 47,9636 \quad (2)$$

Tiofen – *n*-heksan:

$$w(\text{tiofen}) = -21,9549 \cdot n_{D,25}^2 + 69,9700 \cdot n_{D,25} - 54,6592 \quad (3)$$

Rezultati i rasprava

Ravnoteža kapljevina-kapljevina

Sa svrhom istraživanja mogućnosti primjene odabranih ionskih kapljevina i niskotemperaturnih eutektičkih otapala za ekstrakciju tiofena i piridina iz smjese s *n*-heksanom eksperimentalno su određene binodalne krivulje i vezne linije u trokomponentnim sustavima *n*-heksan – (tiofen ili piridin) – otapalo (ionska kapljevina ili niskotemperaturna eutektička smjesa) pri sobnim uvjetima. Mjerenja su provedena s dvije ionske kapljevine, [C₅mim][Tf₂N] i [bzmim][Tf₂N], odnosno dvije niskotemperaturne eutektičke smjese, [kolin-klorid – glicerol] i [kolin-klorid – urea]. Dobiveni su rezultati prikazani na slikama 1 i 3. Slika 1 prikazuje binodalne krivulje i vezne linije za sustave s tiofenom kao ključnom komponentom.

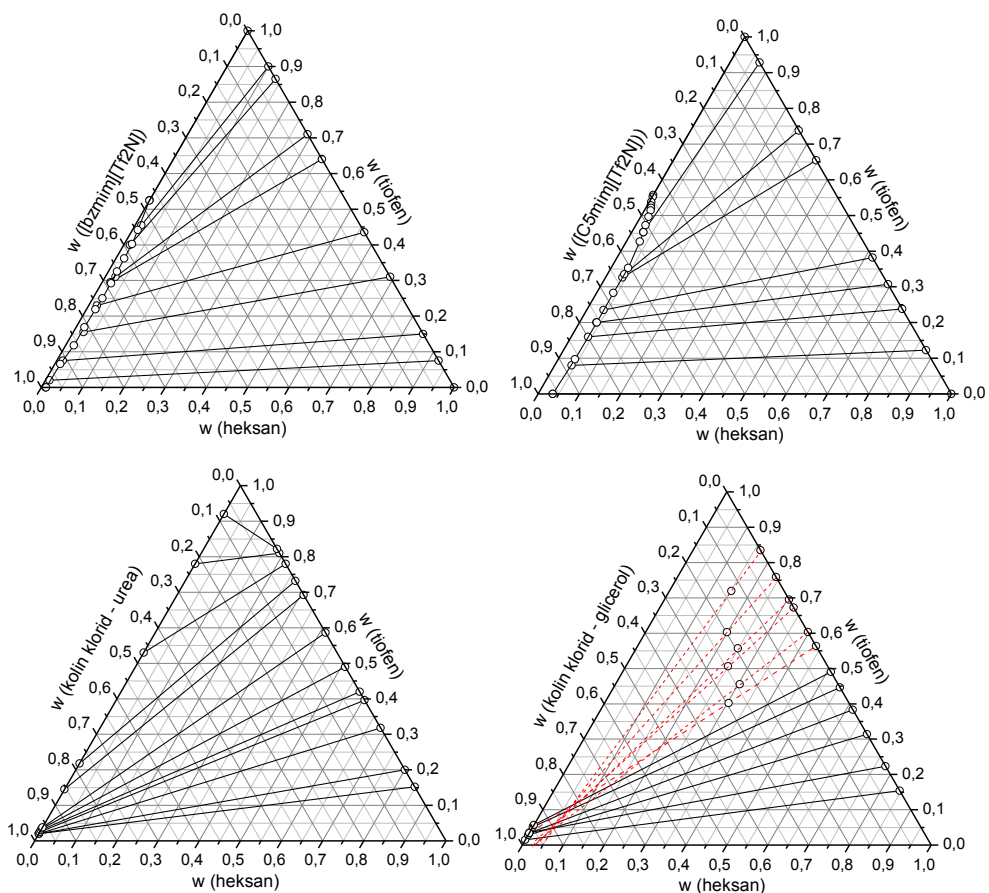

Slika 1. Ravnoteža kapljevina-kapljevina u trokomponentnom sustavu *n*-heksan – tiofen – otapalo
Fig. 1. Liquid-liquid equilibria in the three-component system *n*-hexane – thiophene – solvent

Kemijsko i biokemijsko inženjerstvo / Chemical and Biochemical Engineering

Standardne mjerne nesigurnosti određivanja točaka na binodalnoj krivulji su procijenjene i iznose $u(T) = 0,2$ K, $u(p) = 5$ kPa i $u(w) \leq 0,0006$ za rafinatnu fazu u sustavu s $[C_5mim][Tf_2N]$ te $u(w) \leq 0,003$ u sustavu s $[bzmim][Tf_2N]$. Standardne mjerne nesigurnosti za ekstraktnu fazu mogu se točno izračunati jedino za točke na binodalnoj krivulji određene za dvokomponentne sustave jer se jedino ti sastavi mogu eksperimentalno odrediti. Procijenjene vrijednosti su $u(w) \leq 0,003$. Standardne mjerne nesigurnosti određivanja veznih linija su procijenjene i iznose $u(T) = 0,2$ K, $u(p) = 5$ kPa i $u(w) \leq 0,0006$ za rafinatnu fazu. Sastavi ekstraktne faze su izračunati korištenjem ravnotežnih podataka i bilance tvari te procijenjene na $u(w) \leq 0,005$. Sva istraživana otapala netopljiva su u *n*-heksanu. S druge strane *n*-heksan je slabo topljiv u ionskim kapljevinama i potpuno netopljiv u eutektičkim otapalima što ukazuje na veću selektivnost niskotemperaturnih eutektičkih otapala. Vezne linije su negativnog nagiba, osim u sustavu s [kolin-klorid – ureom] gdje je pri koncentraciji tiofena u *n*-heksanu većoj od 0,8 uočena promjena nagiba. Na slici 2 prikazan je 1H NMR spektar [kolin-klorid – glicerola] (1:2) nakon miješanja s otopinom tiofena u *n*-heksanu. Na spektru se osim pikova karakterističnih za otapalo mogu uočiti samo pikovi koji odgovaraju tiofenu (1,147 i 1,667 ppm), čime je potvrđena netopljivost *n*-heksana u otapalu.

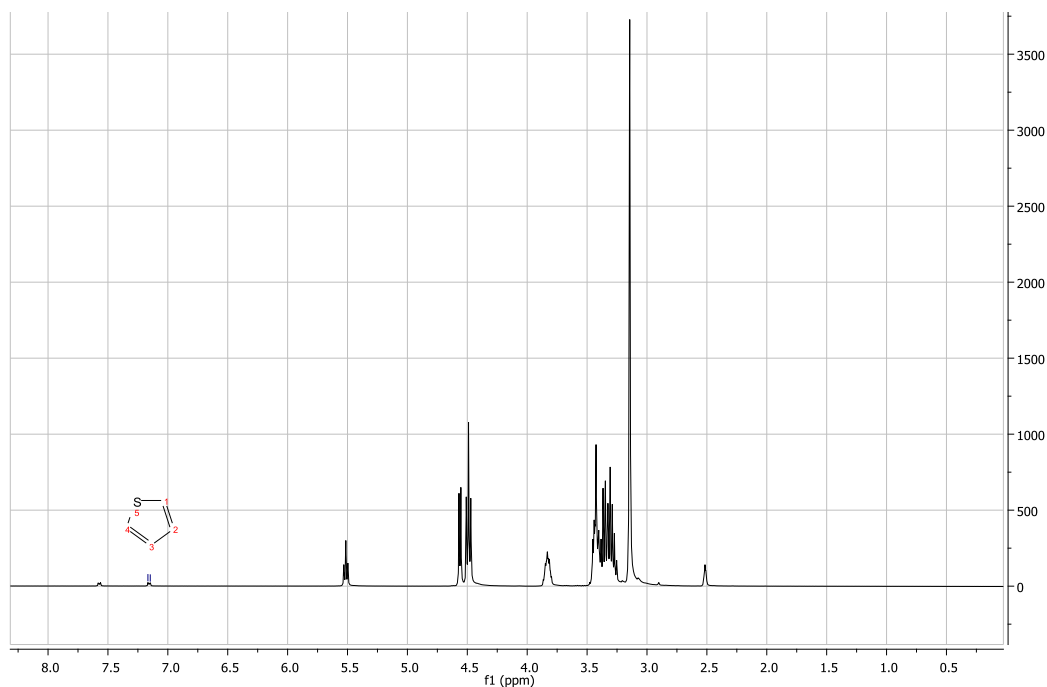

Slika 2. 1H NMR spektar smjese tiofena, *n*-heksana i [kolin-klorid – glicerola] (1:2)

Fig. 2. 1H NMR spectra of the mixture of thiophene, *n*-hexane and [cholin chloride – glycerol] (1:2)

Eksperimentalno određene fazne ravnoteže kapljevine-kapljevine za sustave s piridinom kao ključnom komponentom prikazane su na slici 3. Ravnotežni dijagrami sustava s ionskim kapljevinama su tipa I s pozitivnim nagibom veznih linija u cijelom području koncentracija ispod binodalne krivulje. Međutim, u sustavima s niskotemperaturnim eutektičkim otapalima ravnotežni su dijagrami slični kao i u sustavima s tiofenom. *n*-heksan je netopljiv u niskotemperaturnim eutektičkim otapalima što se može vidjeti na ¹H NMR spektru prikazanom na slici 4, gdje se mogu uočiti samo pikovi koji odgovaraju piridinu (7,37; 7,39; 7,41; 8,57 i 8,59 ppm). Na temelju dobivenih rezultata može se zaključiti da su odabrana otapala pogodna za separaciju tiofena i piridina iz smjese sa *n*-heksanom.

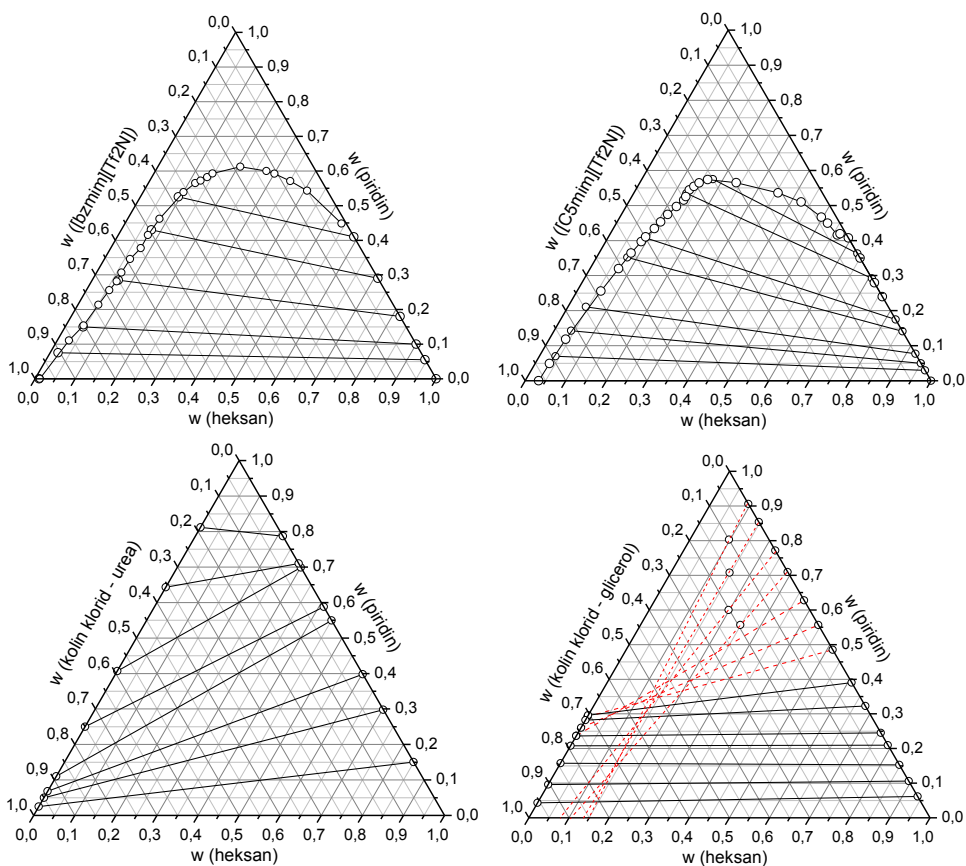

Slika 3. Ravnoteža kapljevine-kapljevine u trokomponentnom sustavu
n-heksan – piridin – otapalo

Fig. 3. Liquid-liquid equilibria in the three-component system *n*-hexane – pyridine – solvent

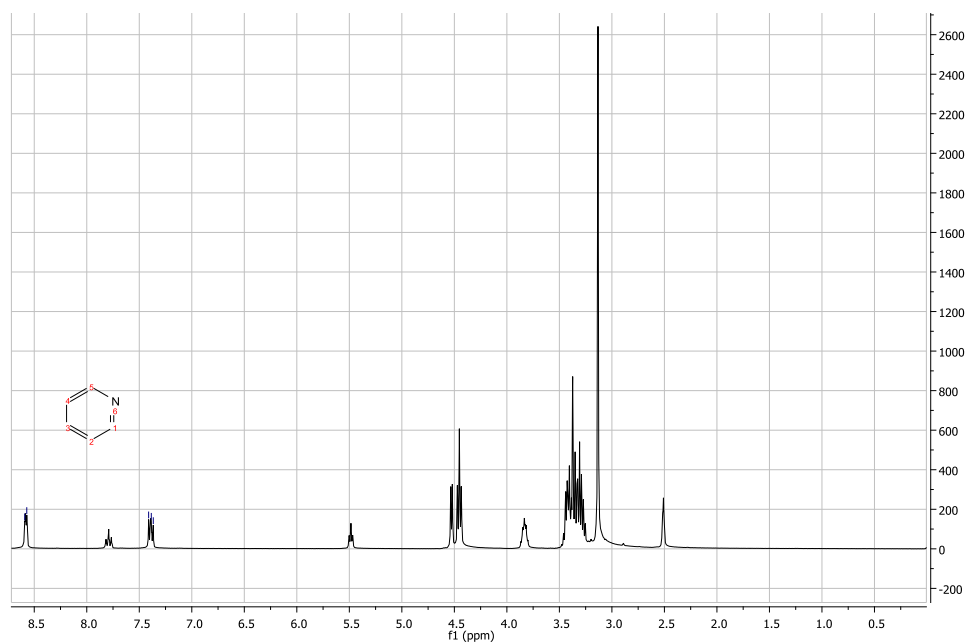

Slika 4. ^1H NMR spektar smjese tiofena, *n*-heksana i [kolin-klorid – glicerola] (1:2)

Fig. 4. ^1H NMR spectra of the mixture of thiophene, *n*-hexane and [cholin chloride – glycerol] (1:2)

Koeficijenti raspodjele i selektivnost

Koeficijenti raspodjele, β_i , i selektivnost otapala, S , izračunati su korištenjem sljedećih izraza:

$$\beta_1 = \frac{w_1^{\text{II}}}{w_1^{\text{I}}} \quad (4)$$

$$\beta_2 = \frac{w_2^{\text{II}}}{w_2^{\text{I}}} \quad (5)$$

$$S = \frac{\beta_2}{\beta_1} \quad (6)$$

i prikazani na slikama 5 – 8. w označava maseni udio, oznake I i II odgovaraju rafinatnoj, odnosno ekstraktnoj fazi, a oznake 1 i 2 odgovaraju ugljikovodiku, odnosno piridinu ili tiofenu.

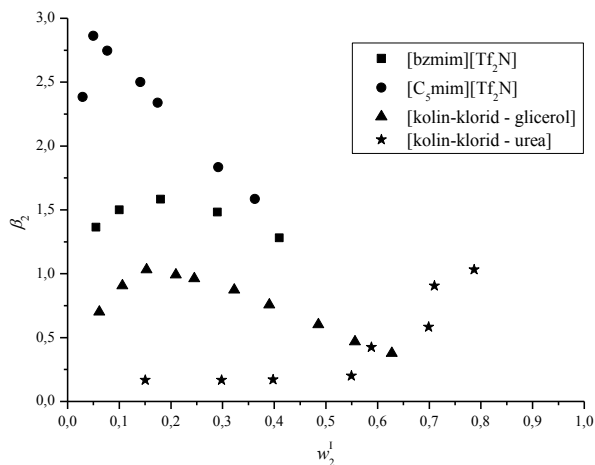

Slika 5. Ovisnost koeficijenta raspodjele piridina, β_2 , o masenom udjelu piridina u rafinatnoj fazi, w_2^I , za sustave *n*-heksan – piridin – otapalo

Fig. 5. Distribution coefficient of pyridine, β_2 , vs. mass fraction of pyridine in the raffinate phase, w_2^I , for the system *n*-hexane – pyridine – solvent

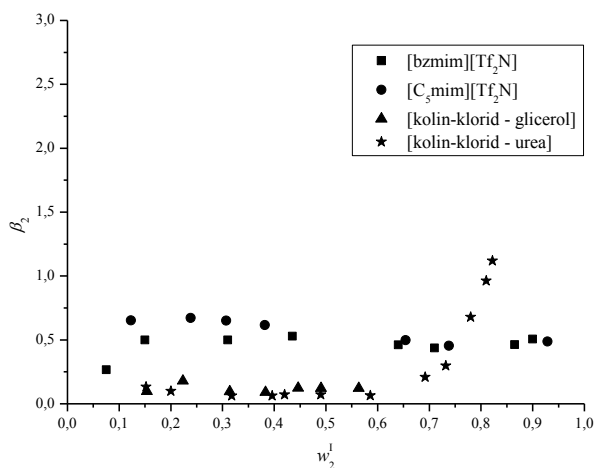

Slika 6. Ovisnost koeficijenta raspodjele tiofena, β_2 , o masenom udjelu tiofena u rafinatnoj fazi, w_2^I , za sustave *n*-heksan – tiofen – otapalo

Fig. 6. Distribution coefficient of thiophene, β_2 , vs. mass fraction of thiophene in the raffinate phase, w_2^I , for the system *n*-hexane – thiophene – solvent

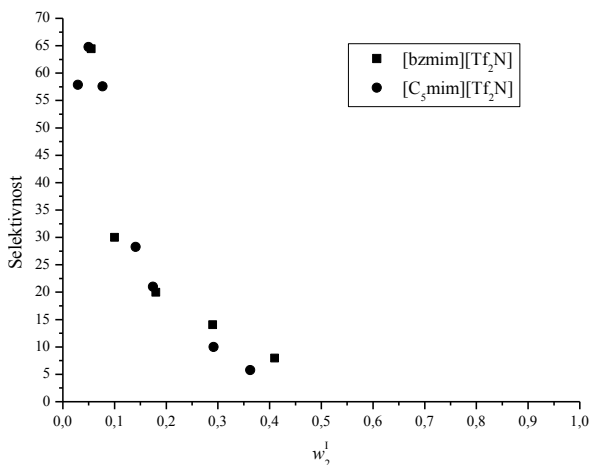

Slika 7. Ovisnost selektivnosti, S , o masenom udjelu piridina u rafinatnoj fazi, w_2^I , za sustav n -heksan – piridin – otapalo

Fig. 7. Selectivity, β_2 , vs. mass fraction of pyridine in the raffinate phase, w_2^I , for the system n -hexane – pyridine – solvent

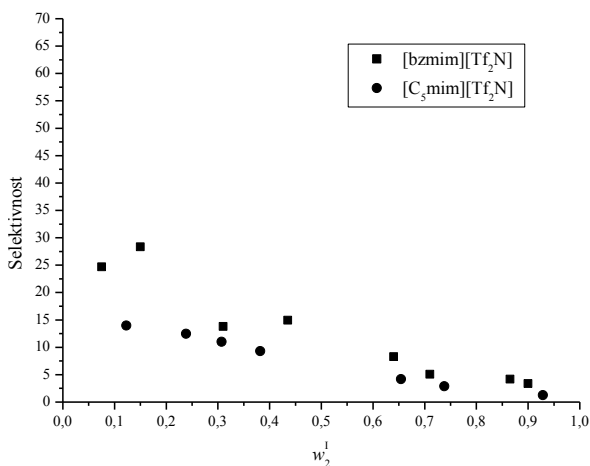

Slika 8. Ovisnost selektivnosti, S , o masenom udjelu tiofena u rafinatnoj fazi, w_2^I , za sustav n -heksan – tiofen – otapalo

Fig. 8. Selectivity, β_2 , vs. mass fraction of thiophene in the raffinate phase, w_2^I , for the system n -hexane – thiophene – solvent

Koeficijenti raspodjele piridina veći su od koeficijenata raspodjele tiofena u svim istraživanim sustavima, pri čemu ovisno o korištenom otapalu opadaju u smjeru: $[C_5mim][Tf_2N] > [bzmim][Tf_2N] > [kolin-klorid - glicerol] > [kolin-klorid - urea]$. To drugim riječima znači da je topljivost piridina u odgovarajućem otapalu veća od topljivosti tiofena. Utjecaj koncentracije ključne komponente na vrijednost pripadajućeg koeficijenta raspodjele veći je u sustavima s piridinom. S porastom koncentracije piridina opada koeficijent raspodjele piridina. Selektivnost ionskih kapljevine opada s porastom koncentracije ključne komponente u smjesi, jer je sve veća topljivost ugljikovodika u ionskoj kapljevine. Selektivnost niskotemperaturnih eutektičkih smjesa veća je od selektivnosti ionskih kapljevine s obzirom na to da je *n*-heksan netopljiv u $[kolin-klorid - glicerolu]$ i $[kolin-klorid - urei]$. Visoke vrijednosti selektivnosti idu u prilog korištenja odabranih otapala za separaciju piridina i tiofena od parafinskih ugljikovodika. Raspravi treba pridodati prethodno objavljena fizikalna svojstva ionskih kapljevine (Gabrić i sur., 2013) i niskotemperaturnih eutektičkih smjesa (Sander et al., 2016). $[C_5mim][Tf_2N]$ ima manju viskoznost (0,0525 Pa s) od $[bzmim][Tf_2N]$ (0,1508 Pa s). Otapala manje viskoznosti lakše se dispergiraju i pružaju manji otpor međufaznom prijenosu tvari. Viskoznosti $[kolin-klorid - glicerola]$ i $[kolin-klorid - uree]$ još su veće (0,3027 Pa s i 1,5262 Pa s) pa je za očekivati da je i teži prijenos tvari u ta otapala. Budući da je svrha ovog istraživanja vezana za procese desulfurizacije i denitrifikacije motornih goriva čije su gustoće u rasponu od 710 do 840 kg m⁻³, znatno veće gustoće odabranih otapala ($\rho ([C_5mim][Tf_2N]) = 1404 \text{ kg m}^{-3}$; $\rho ([bzmim][Tf_2N]) = 1491 \text{ kg m}^{-3}$; $\rho ([kolin-klorid - glicerol]) = 1201 \text{ kg m}^{-3}$ i $\rho ([kolin-klorid - urea]) = 1205 \text{ kg m}^{-3}$) također idu u prilog korištenju ovih otapala u procesu ekstrakcije jer osiguravaju jednostavnu separaciju faza.

Zaključci

Na temelju eksperimentalno određenih faznih ravnoteža kapljevine-kapljevine za sustave *n*-heksan – piridin ili tiofen – otapalo, može se zaključiti da se ionske kapljevine i niskotemperaturne eutektičke smjese mogu koristiti kao selektivna otapala da desulfurizaciju i denitrifikaciju smjesa ugljikovodika. Koeficijenti raspodjele veći su u sustavima s ionskim kapljevinama, a niskotemperaturne eutektičke smjese su selektivnije. S obzirom na veće vrijednosti koeficijenata raspodjele i selektivnosti, otapala će biti pogodnija za denitrifikaciju nego za desulfurizaciju.

Odabrane ionske kapljevine i niskotemperaturne eutektičke smjese mogu se koristiti kao selektivna otapala u procesu uklanjanja tiofena i piridina iz smjese s *n*-heksanom, ekstrakcijom kapljevine-kapljevine. Očekuje se da će učinkovitost otapala u procesima desulfurizacije i denitrifikacije opadati u smjeru: $[C_5mim][Tf_2N] > [bzmim][Tf_2N] > [kolin-klorid - glicerol] (1:2) > [kolin-klorid - urea] (1:2)$.

¹H NMR spektroskopijom utvrđeno je da u procesu prijenosa tvari sudjeluju samo tiofen i piridin, s obzirom na to da prisutnost *n*-heksana u ionskim kapljevinama i niskotemperaturnim eutektičkim smjesama nije uočena.

Literatura

Capello, C., Fischer, U., Hungerbuhler, K. (2007): What is a green solvent? A comprehensive framework for the environmental assessment of solvents, *Green Chem.* 9, 927-934.

- Earle, M.J., Seddom, K.R. (2000): Ionic liquids. Green solvents for the future, *Pure Appl. Chem.* 72, 1391-1398.
- Abbott, A.P., Harris, R.C., Ryder, K.S., D'Agostino, C., Gladden, L.F., Mantle, M.D. (2011): Glycerol eutectics as sustainable solvent systems, *Green Chem.* 13, 82-90.
- Freemantle, M. (1998): Designer solvents – Ionic liquids may boost clean technology development, *Chem. Eng. News* 76, 32-37.
- Anugwom, I., Maki-Arvela, P., Salmi, T., Mikkola, J.-P. (2011): Ionic liquid assisted extraction of nitrogen and sulfur-containing air pollutants from model oil and regeneration of the spent ionic liquid, *J. Environ. Prot.* 2, 796-802.
- Shu, C., Sun, T. (2016): Extractive desulfurisation of gasoline with tetrabutyl ammonium chloride-based deep eutectic solvents, *Separ. Sci. Technol.* 51, 1336-1343.
- Pena-Pereira, F., Namieśnik, J. (2014): Ionic liquids and deep eutectic mixtures: sustainable solvents for extraction processes, *Chem. Sus. Chem.* 7, 1784-1800.
- Song, C. (2003): An overview of new approaches to deep desulfurization for ultra-clean gasoline, diesel fuel and jet fuel, *Catal. Today* 86, 211-263.
- Stanislaus, A., Marafi, A., Rana, M.S. (2010): Recent advances in the science and technology of ultra low sulfur diesel (ULSD) production, *Catal. Today* 153, 1-68.
- Francisco, M., Arce, A., Soto, A. (2010): Ionic liquids on desulfurisation of fuel oils, *Fluid Phase Equilibr.* 294, 39-48.
- Ravilla, U.K., Banerjee, T. (2012): Liquid liquid equilibria of imidazolium based ionic liquid + pyridine + hydrocarbon at 298.15 K: Experiments and correlations, *Fluid Phase Equilibr.* 324, 17-27.
- Wilfred, C.D., Kiat, C.F., Man, Z., Bustam, M.A., Mutalib, M.I.M., Phak, C.Z. (2012): Extraction of dibenzothiophene from dodecane using ionic liquids, *Fuel Process. Technol.* 93, 85-89.
- Ceron, M.A., Guzman-Lucero, D.J., Palomenque, J.F., Martinez-Palou, R. (2012): Parallel microwave-assisted synthesis of ionic liquids and screening for denitrogenation of straight-run diesel feed by liquid-liquid extraction, *Comb. Chem. High Throughput Screen* 15, 427-432.
- Casal, M.F. (2010): Desulfurization of fuel oils by solvent extraction with ionic liquids, PhD thesis, University of Santiago de Compostela, Santiago de Compostela
- Li, J.-J., Xiao, H., Tang, X.-D., Zhou, M. (2016): Green carboxylic acid-based deep eutectic solvents as solvents for extractive desulfurization, *Energ. Fuel* 30, 5411-5418.
- Hizaddin, H.F., Ramalingam, A., Ali Hashim, M., Hadj-Kali, M.K.O. (2014): Evaluating the performance of deep eutectic solvents for use in extractive denitrification of liquid fuels by the conductor-like screening model for real solvents, *J. Chem. Eng. Data* 59, 3470-3487.
- Sander, A., Rogošić, M., Slivar, A., Žuteg, B. (2016): Separation of hydrocarbons by means of liquid-liquid extraction with deep eutectic solvents, *Solvent Extr. Ion Exc.* 34, 86-98.
- Gabrić, B., Sander, A., Cvjetko Bubalo, M., Macut, D. (2013): Extraction of S- and N-compounds from the mixture of hydrocarbons by ionic liquids as selective solvents, *Sci. World J.* 2013, 1-11.

Original research paper

The use of ionic liquids and deep eutectic solvents in extractive desulfurization and denitrification

Kristina Zagajski Kučan, Marko Rogošić, Aleksandra Sander*

*University of Zagreb, Faculty of Chemical Engineering and Technology,
Marulićev trg 20, 10000 Zagreb, Croatia*

**Corresponding author: asander@fkit.hr*

Summary

In the last decade an upward trend in world energy demand can be observed, which in the transport sector means a steady increase in the consumption of fossil fuels and thus an increase in emissions of combustion products that adversely affect the environment and are responsible for climate change. Commercial industrial processes of hydrodesulfurization and hydrodenitrogenation are environmentally and energetically unfavorable, which led to the development of alternative methods for obtaining the required fuel quality. One of the methods which are largely explored is the liquid-liquid extraction. The development and superior properties of ionic liquids and deep eutectic solvents enabled their use in the extraction.

Knowledge of the physical and chemical properties and liquid-liquid phase equilibria allows for the evaluation of the applicability of solvents in the extraction processes. In this paper liquid-liquid phase equilibria are experimentally determined in which the thiophene and pyridine takes place as a key component, *n*-hexane is the primary solvent and a ionic liquid or deep eutectic solvent is the secondary solvent. The possibility of using these solvents in the processes of separation of sulfur and nitrogen compounds from their mixtures with *n*-hexane is estimated on the basis of the distribution and selectivity coefficients. The values of distribution coefficients are higher for systems with ionic liquids, and deep eutectic solvents are found more selective. Both types of environmentally friendly solvents have the potential for use in processes of desulfurization and denitrification of motor fuels.

Keywords: denitrification, desulfurization, liquid-liquid extraction, deep eutectic solvents, ionic liquids

Original research paper

Catalytic performance of mixed Mn-M (M: Fe, Ni, Cu) oxides in toluene oxidation

Marina Duplančić*, Kristina Babić, Vesna Tomašić, Zoran Gomzi

*University of Zagreb, Faculty of Chemical Engineering and Technology,
Department of Reaction Engineering and Catalysis, Marulićev trg 19, 10000 Zagreb, Croatia*

**Corresponding author: marina.duplancic@fkit.hr*

Summary

Volatile organic compounds (VOCs) are recognized as the major contributors to global air pollution and the development of the effective methods and materials for the abatement of VOCs became of great importance. Catalytic oxidation is the most promising technology for VOC abatement and most of the catalysts used for this purpose are, generally, very active but also very expensive noble metals (Pt, Pd, etc). Therefore, many efforts have been made towards the design of cheaper catalyst materials based on the mixed transition metal oxides.

This paper deals with preparation, characterization and catalytic activity of the mixed manganese oxides, Mn-M (M: Fe, Ni, Cu) used for catalytic oxidation of toluene. Catalysts were synthesized by the coprecipitation method and various instrumental techniques were used for their characterization. Catalytic tests were performed in the fixed bed flow reactor. The influences of different reaction conditions on the catalytic performance were examined using gaseous mixture of toluene and nitrogen (242ppm of toluene/nitrogen) and air as an oxidant. Tests were performed at different temperatures (373-675K) and various total flow rates of the reaction mixture (23-138cm³/min) at the constant catalyst mass (0.05g).

Obtained mesoporous catalysts show high low-temperature activities for the toluene oxidation with T₉₀ temperatures, corresponding to 90% of the toluene conversion, observed at 450K and even lower temperatures.

Keywords: Catalytic oxidation, toluene, mixed manganese oxides, coprecipitation

Introduction

Volatile organic compounds (VOCs) are recognized as the major contributors to global air pollution (Heck et al., 2009). Transportation vehicles and a wide range of industrial processes are the most important anthropogenic sources of VOCs. Volatile organic compounds include a vast number of organic compounds with a low boiling point at atmospheric pressure, usually with fewer than 12 carbon atoms and divided into methane and non- methane compounds. They are the major contributors to global warming and air pollution, the pre-cursors of ozone, photochemical smog and secondary aero-sol (Amann et al., 2000). VOCs are also the most abundant and harmful chemical pollutants in indoor air (Mo et al., 2009).

Toluene is quite often chosen as a model compound by many researchers in the field (Barbero et al., 2008; Li et al., 2012; Özçelik, 2014). The US Environmental Protection Agency (US EPA) and National Institute of Occupational Safety and Health (NIOSH) list several toluene concentration limits that people should not be exposed to, depending on the exposure time (<https://www.epa.gov/haps/health-effects-notebook-hazardous-air-pollutants>; NIOSH, 2007). The REL value (recommended exposure limit) of 100ppm as the recommended limit value for 8 or 10h average exposure time defined by NIOSH is comparable with Croatian regulations that define 50ppm or 190mg/m³ as the maximum permissible concentration (MPC) of toluene in a work premises and areas, while the biological limit value (BGV) for occupational exposure to toluene in blood at the end of the work shift is 10.85mmol/dm³ (1.0 mg/dm³) (Dujmović, 1993).

Mentioned, and many other limit values have tendency of lowering their values with new health impact research, so the development of the effective methods and materials for the abatement of VOCs is of great importance. Catalytic oxidation as the most promising technology for the destruction of VOCs (Huang et al., 2015; Chen et al., 2009; Everaert, 2004) with the suitable catalyst can convert VOCs into CO₂ and water at low process temperatures. Most of the catalysts used for VOC combustion are noble metals dispersed on porous supports (e.g. platinum or palladium on alumina, silica, etc.), very active, but also expensive. Therefore, many endeavors have been made to design catalysts based on the mixed transition metal oxides (Ni, Cu, Cr, Mn, Fe, etc.), as cheaper and adequately active substitutes. Manganese oxides exhibited high activities in catalytic oxidation of VOCs (Bastos, 2012; Morales, 2007; Ferrandon, 1999; Craciun, 2003), but mixed with other transition metal oxides they have shown even higher activities (Lin, 2001; Mehandjiev, 2001). This paper deals with characterization and the performance of three mixed metal oxides, Mn-M (M: Fe, Ni, Cu). Various characterization techniques, such as X-ray diffractometry (XRD), BET-surface area analysis, scanning electron microscopy (SEM), thermal analysis and the N₂ adsorption/desorption at 77K were used for the catalyst characterization. The activities of powder manganese mixed oxide catalysts Mn-M (M: Fe, Ni, Cu) were evaluated in the catalytic combustion of toluene using a fixed bed reactor. The influences of the space velocities, temperatures and the particle size on the catalytic performance were examined. Toluene, as a representative aromatic VOC was chosen as a single model VOC compound for testing the catalytic performance of mentioned catalysts.

Materials and Methods

Catalyst preparation

Powder catalysts based on the mixed manganese oxides, Mn-M (M: Fe, Ni, and Cu) were synthesized by the co-precipitation method. Equal volumes of 0.25mol/dm³ aqueous solutions of manganese (II) nitrate tetrahydrate and one of the transitional metal (Fe, Ni or Cu) nitrates (e.g. iron (III) nitrate nonahydrate, nickel (II) nitrate hexahydrate or copper (II) nitrate trihydrate) were mixed and stirred. Sodium carbonate solution was added under stirring and pH of the solutions was adjusted to 8.4. Suspensions were filtrated and washed thoroughly with deionized water and obtained catalysts were dried and calcined as shown in Fig. 1.

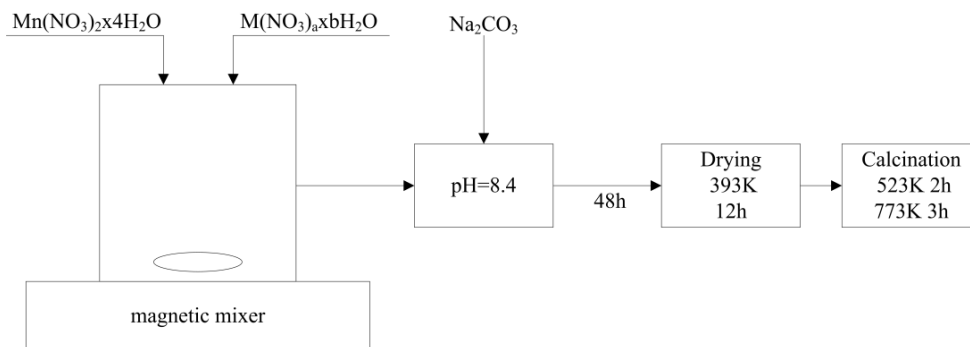

Fig. 1. Schematic illustration of the powder catalyst preparation

Catalyst characterization

Characterization of prepared catalysts included nitrogen adsorption-desorption analysis, scanning electron microscopy (SEM) with energy dispersive X-ray analysis (EDX), differential scanning calorimetry (DSC), temperature programmed desorption of CO_2 (CO_2 -TPD) and Fourier Transform Infrared Spectroscopy (FTIR) analysis.

The surface morphology and EDX analysis of the catalytic samples were performed on Vega 3 Tescan scanning electron microscope. The textural properties, such as specific surfaces of the catalysts, total pore volumes and average pore diameters were determined based on the Brunauer-Emmet-Teller model (BET) using analysis of N_2 adsorption/desorption at 77K on Micromeritics ASAP 2000 apparatus. The thermal properties of catalysts were analyzed using differential scanning calorimetry, DSC. The analysis was carried out on the Mettler Toledo DSC823^c apparatus. Catalyst sample was heated in the temperature range of 298 – 823K in inert gas atmosphere (N_2 , 50cm³/min) with a heating rate of 10K/min. Temperature programmed CO_2 desorption (CO_2 -TPD) analysis was performed using Micromeritics AutoChem 2010. Samples were pre-treated in helium stream and the adsorption was carried out by introducing CO_2 . The samples were then washed in helium stream to remove physically adsorbed CO_2 . TPD signals were recorded while samples were gradually heated at the rate of 10K/min to a maximum temperature of ca. 1200K in 50cm³/min helium stream.

Fourier Transform Infrared Spectroscopy (FTIR) was performed on PerkinElmer[®] Spectrum One at room temperature with a spectral range from 400 to 4000cm⁻¹.

Catalytic tests

Activities of the synthesized Mn-M catalysts were tested in the toluene combustion using gaseous mixture of toluene and nitrogen (242ppm of toluene/nitrogen) and air as an oxidant. Tests were performed in the fixed bed reactor at different temperatures (373-675K), under atmospheric pressure and various total flow rates of reaction mixture (23-138cm³/min) with the constant catalyst mass (0.05g). Inlet concentration of toluene in the reaction mixture was constant. The reactor temperature was regulated by a thermo-controller (TC208 Series) and gas flow rates were regulated by mass flow controllers (Brooks) (Fig. 2.). Reaction products were analyzed *on-line* using a Shimadzu GC-2014 gas chromatographer equipped with Carbowax 20M packed column and a FID detector. The catalytic activity was evaluated in terms of toluene conversion.

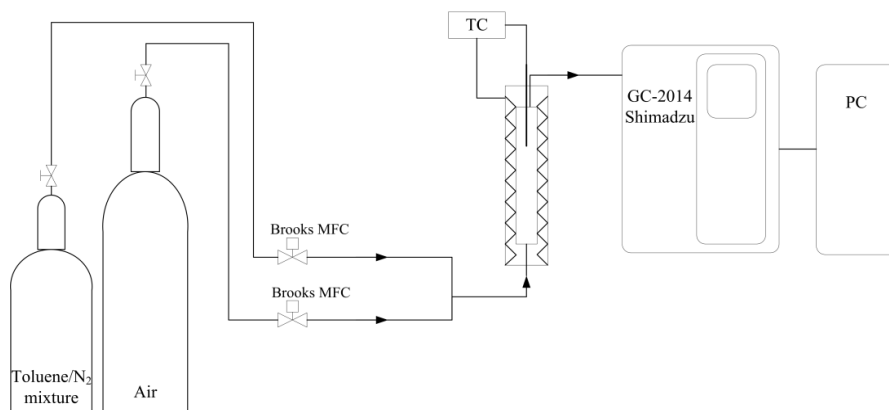

Fig. 2. Schematic representation of the experimental system

The blank test was carried out in the fixed bed reactor without catalyst and results showed that conversion of toluene starts at 575K and up.

Results and Discussion

The catalytic performance of the mixed manganese oxides, Mn-M (M: Fe, Ni, Cu) was evaluated in catalytic oxidation of toluene using the fixed bed reactor. Toluene, as one of the representative aromatic VOCs, extensively applied in different fields of industry, was chosen as a model VOC compound. The home-made catalysts with average pore diameters of ca. 20nm can be classified as mesoporous catalysts according to the IUPAC standards. As shown by the nitrogen adsorption-desorption analysis in Table 1. out of the three studied mixed metal oxides Mn-Ni and Mn-Fe have quite similar total pore volumes and average pore diameters, with Mn-Fe having the highest specific surface area, while Mn-Cu has the lowest values in all three observed textural properties (e.g. surface area, total pore volume and mean pore diameter).

Table 1. Textural properties of the catalysts as determined from nitrogen adsorption at 77K

	$S_{\text{BET}}, \text{m}^2/\text{g}$	$V_{\text{pore}}, \text{cm}^3/\text{g}$	$d_{\text{pore}}, \text{nm}$
Mn-Ni	38.3991±0.4030	0.1956	20.4
Mn-Fe	44.3743±0.3228	0.2115	19.1
Mn-Cu	23.6471±0.1889	0.0973	16.5

The morphology of the Mn-M oxide catalysts was further checked by the scanning electron microscopy (SEM) at different magnifications and observed results are shown in Fig. 3. It was observed that the surface of all three catalysts consists mostly of the spherical clusters with typical dimensions of about 1 micron.

The EDX results showed almost a stoichiometric ratio of manganese and nickel in the Mn-Ni catalyst close to one, which was in accordance to the preparation procedure (Fig. 1). For the other two catalysts, Mn-Fe and Mn-Cu the molar ratio was closer to 0.5 indicating that possible corrections in preparation procedures need to be made (e.g. probably the pH value should be more precisely controlled) if we want to maintain Mn:M ratio close to one in all three cases.

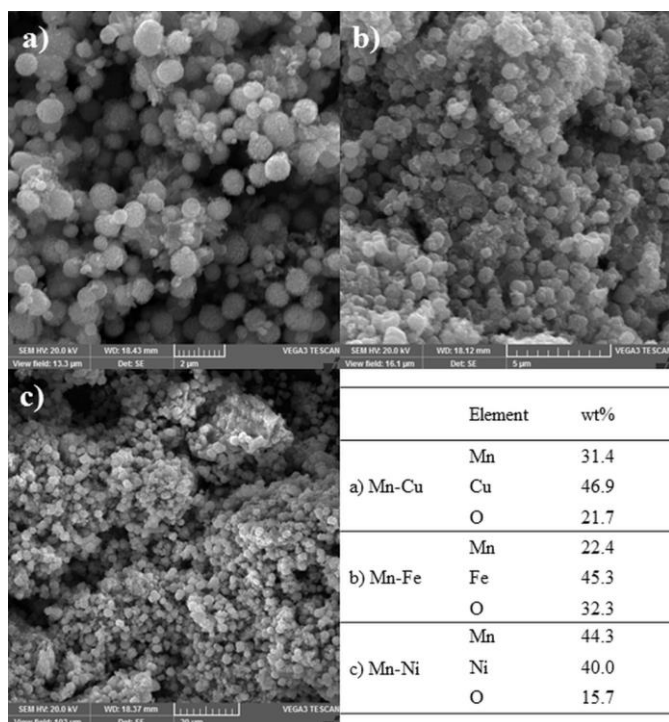

Fig. 3. SEM images and composition of the Mn-M (M: Fe, Ni, Cu) mixed oxides determined by EDX analysis

Differential scanning calorimetry (DSC) over a wide range of temperatures (298 - 823K) was used to investigate the thermal properties of Mn-M mixed oxides and results are illustrated in the Fig. 4. The first endothermic peak ending at ca. 475K in all three Mn-M catalysts can be attributed to water desorption. Interestingly, the presence of second endothermic peak observed in the temperature range from 523K to ca. 655K for all prepared mixed Mn-M (M: Fe, Ni, and Cu) oxide catalysts indicates a structural change of the catalysts which is accompanied by the release of energy of -35J/g, -186J/g and -209J/g, respectively. In line with these observations before testing the catalyst activity for toluene oxidation the catalyst was pretreated (calcined) at the temperature of 523 K for 2 hours and then for 3 hours at the temperature of 773K.

After calcination these endothermic peaks do not appear on repeated DSC analysis, indicating that catalysts are structurally stable and as such ready to be used in the catalytic reaction.

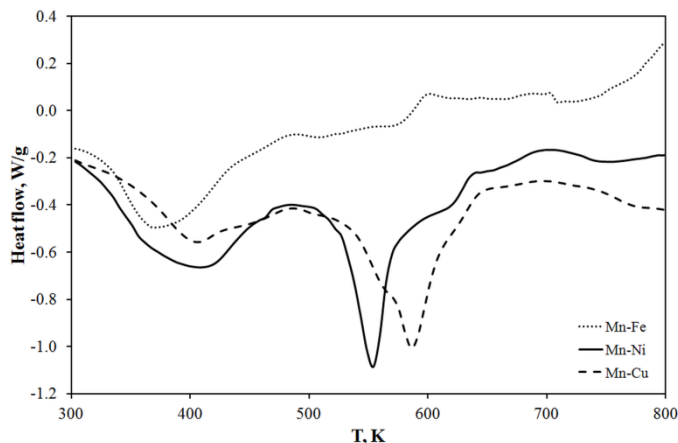

Fig. 4. DSC curve of the Mn-M (M: Fe, Ni, Cu) mixed oxides

The synthesized mixed manganese oxide samples were characterized by CO₂-TPD and results are shown in the Fig. 5. Mixed Mn-Ni oxide shows somewhat different behavior compared to the other two mixed oxides (e.g. Mn-Fe and Mn-Cu). Its unimodal curve with the temperature maximum at 1055 K is in contrast to the other two oxides with detected two temperature peaks (Mn-Fe at 1004K and 1102K; Mn-Cu at 958K and 1173K). The basic sites present in all three catalysts can be classified as strong basic sites as they all appear above 750K.

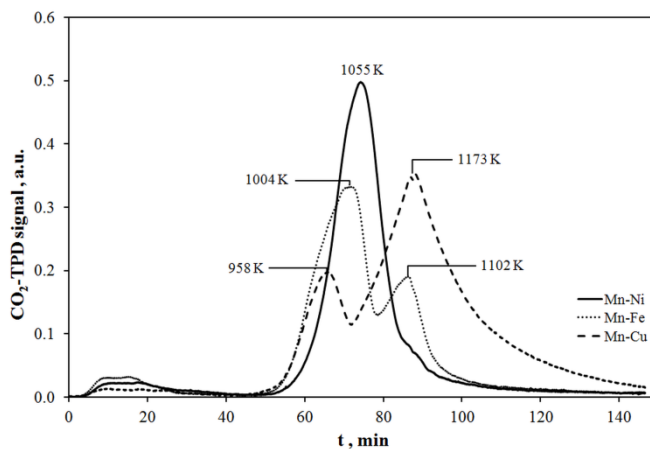

Fig. 5. CO₂-TPD profiles of the Mn-M (M: Fe, Ni, Cu) mixed oxides

Kemijsko i biokemijsko inženjerstvo / Chemical and Biochemical Engineering

Fourier Transform Infrared Spectroscopy (FTIR) spectrum confirmed that during the toluene oxidation over Mn-M (M: Fe, Ni, Cu) oxide catalysts there was no significant adsorption of the reactants or possible reaction intermediates (e.g. benzaldehyde or benzoic acid) on the surface of the catalysts (comparison between FTIR results before and after the reaction for each catalyst are not shown here). However the spectrums of all three mixed metal catalysts (Fig. 6.) show very similar peaks. The peaks at 525 1/cm (M-O asymmetric stretching) and 630 1/cm (M-O wagging) imply the presence of metal-oxide group in the catalysts. The metal–oxygen bond is also observed at 1368 1/cm (M-O rocking in plane) and at 1631 1/cm (M-O rocking out of plane). Some nitrogen or carbon containing molecules were probably adsorbed during catalyst preparation and the peaks at 1736 1/cm (C=O or M-H stretching) and at 1228 1/cm (C-O stretching) can be attributed to that.

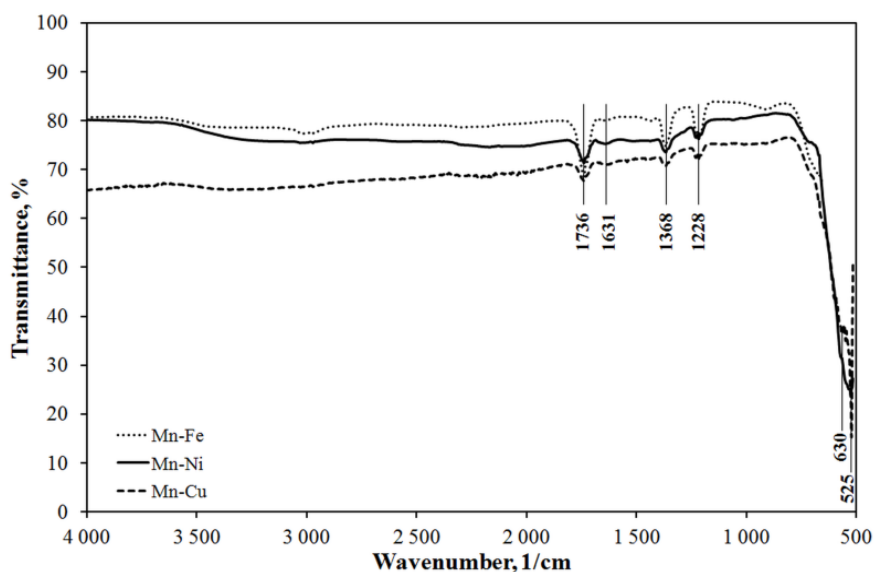

Fig. 6. The FTIR spectrums of the Mn-M (M: Fe, Ni, Cu) mixed oxides

The prepared catalysts were catalytically evaluated in the catalytic combustion of toluene using a fixed bed reactor and previously described experimental system (Fig. 2.). Catalytic performances of the Mn-M (M: Fe, Ni, Cu) catalysts were tested at different reaction temperatures, different total flow rates of reaction mixture, at constant inlet toluene concentration (242ppm) and constant catalyst mass (0.05g). It is evident (Fig.7.) that with temperature increase conversion of toluene increases at all flow rates and achieve maximum conversion values depending on the space times. When operating at a lower total flow rates of the reaction mixture (higher space times) maximum conversion is achieved at as low as ca. 450K for Mn-Cu catalyst.

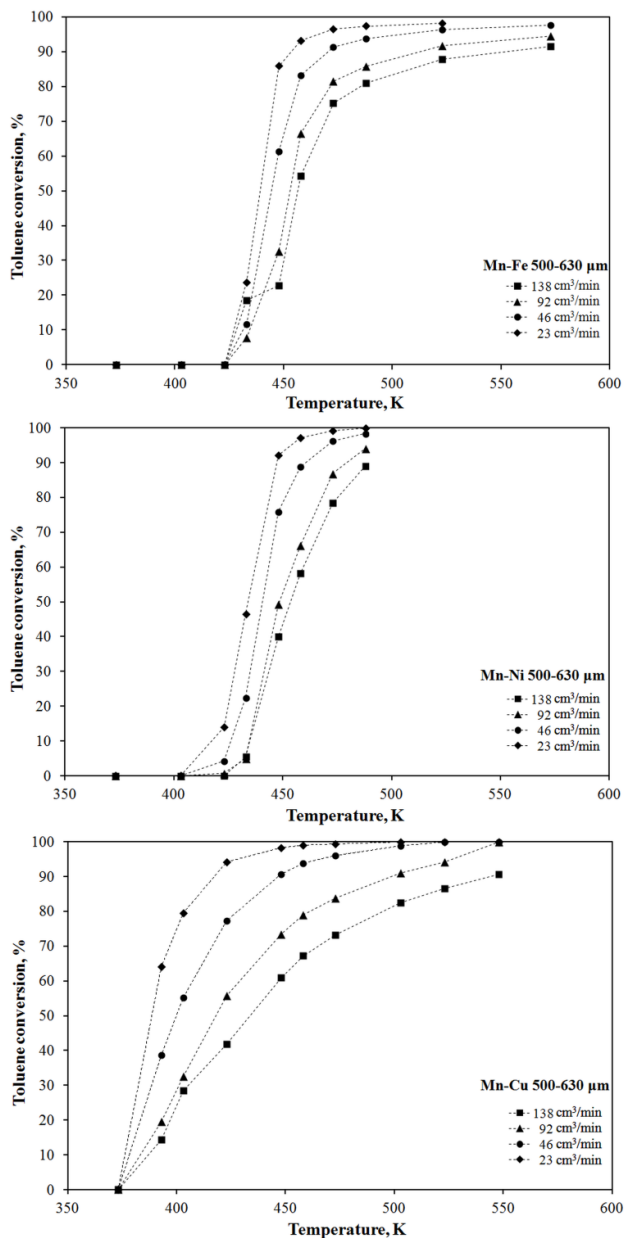

Fig. 7. Catalytic performance of the Mn-M (M: Fe, Ni, Cu) mixed oxides at different temperatures

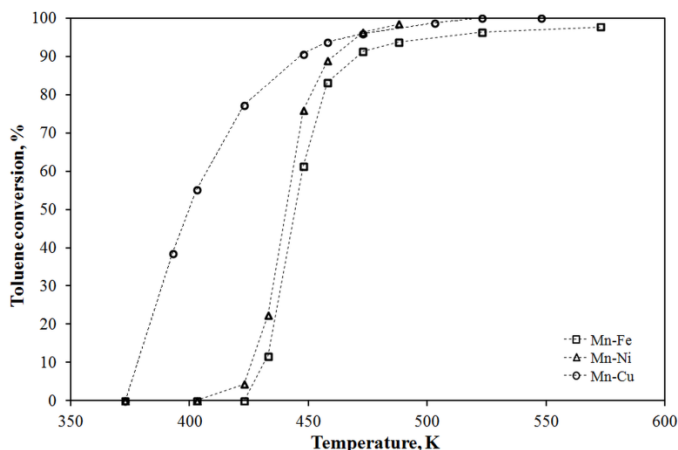

Fig. 8. Comparison of catalytic performances of Mn-M catalytic samples ($46\text{cm}^3/\text{min}$)

The reaction temperature T_{50} corresponding to 50% of the toluene conversion, at the total flow rate of $46\text{cm}^3/\text{min}$, was observed at temperatures of ca. 400K for the Mn-Cu catalyst and at ca. 430K for the other two catalysts (Fig.8). However, T_{90} value, 90% of the toluene conversion, was about the same for all three catalysts, ca. 450K. The effect of catalyst particle size on the conversion of toluene is shown in Fig.9. for Mn-Fe catalyst employing 315-400 μm and 500-630 μm particle size fractions, at total flow rates of 46 and 92 cm^3/min . It can be concluded that reducing the size of the catalyst particle shifts characteristic T_{50} and T_{90} values to lower temperatures due to the lower influence of intraparticle diffusion on the overall reaction rate on smaller particle size fractions.

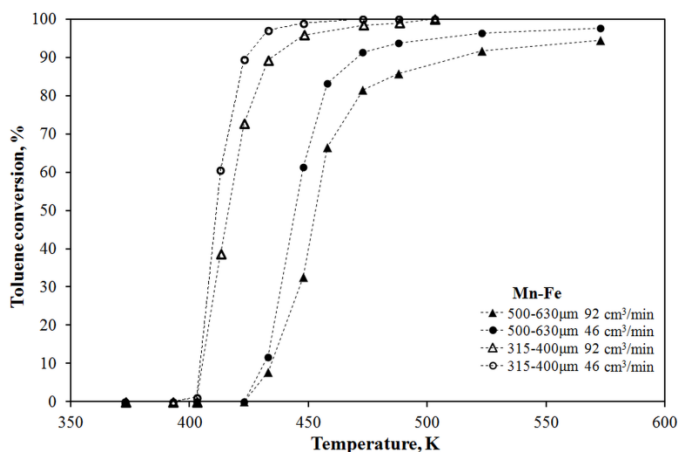

Fig. 9. The effect of catalyst particle size on the catalytic activity of the Mn-Fe catalyst

Obviously, the prepared mixed Mn-M (M: Fe, Ni, and Cu) oxide catalysts showed remarkable activity for the toluene oxidation at the experimental conditions employed in this study. It is particularly important to point out that the observed high conversions were achieved at relatively low temperatures (<500K) and even lower depending on the total flow rate and particle size used, which is crucial for the process efficiency and practical application of those catalyst in real systems.

Conclusions

This paper is a part of extensive research focused on toluene oxidation over manganese mixed oxide catalysts. The high specific surface area, mesoporous structure and favorable temperature programmed desorption of CO₂ from the surface of the mixed Mn-M (M: Fe, Ni, and Cu) oxide catalysts, along with high catalytic activity at relatively low temperatures demonstrated that these catalysts are suitable for the catalytic combustion of toluene at different operation conditions.

References

- Amann, M., Lutz, M. (2000): The revision of the air quality legislation in the European Union related to ground-level ozone, *J. Hazard. Mater.* 78, 41–62.
- Barbero, B. P., Costa-Almeida, L., Sanz, O., Morales, M.R., Cadus, L.E., Montes, M. (2008): Washcoating of metallic monoliths with a MnCu catalyst for catalytic combustion of volatile organic compounds, *Chem. Eng. J.* 139, 430–35.
- Bastos, S.S.T., Carabineiro, S.A.C., Órfão, J.J.M., Pereira, M.F.R., Delgado, J.J., Figueiredo, J.L. (2012): Total oxidation of ethyl acetate, ethanol and toluene catalyzed by exotemplated manganese and cerium oxides loaded with gold, *Catal. Today.* 180, 184-154.
- Chen, H.L., Lee, H.M., Chen, S.H., Chang, M.B., Yu, S.J., Li, S.N. (2009): Removal of volatile organic compounds by single-stage and two-stage plasma catalysis systems: a review of the performance enhancement mechanisms, current status, and suitable applications, *Environ. Sci. Technol.* 43 (7), 2216–2227.
- Craciun, R., Nentwick, B., Hadjiivanov, K., Knözinger, H. (2003): Structure and redox properties of MnO_x/Yttrium-stabilized zirconia (YSZ) catalyst and its used in CO and CH₄ oxidation, *Appl. Catal., A* 243, 67-79.
- Dujmović, V., Sedak-Guszak, M., Habuš, Z., Hribar, E., Majić-Prpić, D., Turk, R., Plavljančić, B., Wider, Lj. (1993): Pravilnik o maksimalno dopustivim koncentracijama štetnih tvari u atmosferi radnih prostorija (MDK) i o biološkim graničnim vrijednostima (BGV), Zagreb, Republika Hrvatska: KA-BI tisak, pp. 21-70.
- Everaert, K., Baeyens, J. (2004): Catalytic combustion of volatile organic compounds, *J. Hazard. Mater.* B109, 113–139.
- Ferrandon, M., Carno, J., Jaras, S., Bjornbom, E. (1999): Total oxidation catalysts based on manganese or copper oxides and platinum or palladium I: Characterisation, *Appl. Catal., A.* 180, 141-15.
- Heck, R. M., Farrauto, R.J., Gulati, S. T. (2009): Volatile organic compounds. In: Catalytic Air Pollution Control: Commercial Technology, 2nd ed., New Jersey, USA: John Wiley & Sons Inc., pp. 281-305.

Kemijsko i biokemijsko inženjerstvo / Chemical and Biochemical Engineering

- Huang, H., Xu, Y., Feng, Q., Leung, D.Y.C. (2015): Low temperature catalytic oxidation of volatile organic compounds: a review, *Catal. Sci. Technol.* 5, 2649–2669.
- Li, Y., Li, Y., Yu, Q., Yu, L. (2012): The catalytic oxidation of toluene over Pd-based FeCrAl wire mesh monolithic catalysts prepared by electroless plating method, *Catal. Commun.* 29, 127–31.
- Lin, R., Liu, W. P., Zhong, Y. J., Luo, M. F. (2001): Catalyst characterization and activity of Ag–Mn complex oxides, *Appl. Catal., A.* 220, 165-171.
- National Institute of Occupational Safety and Health (NIOSH) (2007): Pocket Guide to Chemical Hazards, Cincinnati, USA: NIOSH Publications, pp. 1-454.
- Mehandjiev, D., Naydenov, A., Ivanov, G. (2001): Ozone decomposition, benzene and CO oxidation over NiMnO₃-ilmenite and NiMn₂O₄-spinel catalysts, *Appl. Catal., A.* 206, 13-18.
- Mo, J., Zhang, Y., Xu, Q., Lamson, J.J., Zhao, R. (2009): Photocatalytic purification of volatile organic compounds in indoor air: A literature review, *Atmos. Environ.* 43, 2229–46.
- Morales, M. R., Barbero, B.P., Cadus, L.E. (2007): Combustion of volatile organic compounds on manganese iron or nickel mixed oxide catalysts, *Appl. Catal., B.* 74, 1-10.
- Özçelik, T.G. (2014): VOC treatment by catalytic incineration, *JMEST* 1 (4), 114–118.
<https://www.epa.gov/haps/health-effects-notebook-hazardous-air-pollutants> (October 5th, 2016).

Original research paper

Sinteza biodizela iz otpadnog suncokretovog ulja i butanola uz gvanidinski katalizator

Stjepan Džalto¹, Fabio Faraguna¹, Zoran Glasovac², Ante Jukić^{1*}

¹Sveučilište u Zagrebu, Fakultet kemijskog inženjerstva i tehnologije,
Marulićev trg 19, 10000 Zagreb, Hrvatska

²Institut Ruđer Bošković, Bijenička cesta 54, 10000 Zagreb, Hrvatska

*Dopisni autor: ajukic@fkit.hr

Sažetak

Veliki zahtjevi na ograničene svjetske sirovine potakli su razvoj kružne ekonomije. To je koncept prema kojem bi se proizvodi osmišljavali tako da budu dio vrijednosne mreže unutar koje bi ponovna upotreba i prenamjena proizvoda i materijala zajamčila trajnu reciklažu resursa. Recikliranje otpadnih jestivih ulja uklapa se u navedeni koncept. U ovom radu provedena je i istražena sinteza biodizela iz otpadnog restoranskog ulja i *n*-butanola uz *N,N,N'*-tris(3-dimetilamino)propil gvanidin kao katalizator. Prednost gvanidinskih nad konvencionalnim baznim katalizatorima je izbjegavanje nepoželjnih procesa saponifikacije uz zadržanu visoku aktivnost. Primjenom dizajna pokusa i faktorske analize istražen je utjecaj glavnih procesnih parametara za sintezu biodizela, temperature, vremena, masenog udjela katalizatora te molarnog omjera butanola i ulja na konverziju transesterifikacije. Konverzija je određena NMR spektroskopijom. Dobiven je empirijski model unutar kojeg je za bilo koju kombinaciju ulaznih faktora moguće predvidjeti odziv procesa, konverziju. Valjanost modela provjerena je različitim funkcijama cilja u kojima je bilo zadano postići visoku konverziju uz malu količinu katalizatora. Za jednu od primijenjenih funkcija cilja dobiveni su sljedeći optimalni parametri: temperatura 40,5 °C, vrijeme 30 min, molarni omjer reaktanata 9,8 mol/mol i maseni udio katalizatora 1,4 % uz predviđenu konverziju od 92,4 %. U pripadajućem pokusu, ostvarena je konverzija od 84,9 %.

Cljučne riječi: biodizel, otpadno biljno ulje, butanol, transesterifikacija, gvanidinski katalizator

Uvod

Štetan utjecaj na okoliš koji je posljedica upotrebe fosilnih goriva već niz godina je glavni čimbenik intenziviranja pronalazjenja i uporabe alternativnih, a osobito obnovljivih vrsta goriva (Kiš i sur., 2006). Biodizel je neotrovno, biorazgradivo gorivo koje se dijelom ili u cijelosti dobiva iz obnovljive biomase i jednim dijelom može nadomjestiti fosilno gorivo (Wörgetter i sur., 1991, Sinčić i sur., 2009). Dobiva se iz biljnih ulja i nižih alkohola, pri čemu se zbog etičkih razloga i utjecaja na tržište hrane teži upotrebljavati otpadna biljna ulja. Slično vrijedi i za alkohole koji se mogu proizvoditi konvencionalnim petrokemijskim procesima iz fosilnih sirovina, ali također i iz obnovljivih izvora, odnosno biomase koja se ne upotrebljava za proizvodnju hrane. Tako se metanol može dobiti iz sinteznog plina koji se proizvodi uplinjavanjem biomase, a razvijaju se i biotehnološki procesi kojima se celulozna sirovina prevodi u etanol i butanol.

Kemijsko i biokemijsko inženjerstvo / Chemical and Biochemical Engineering

U ovom radu dani su preliminarni rezultati istraživanja i modeliranja procesa sinteze biodizela iz otpadnog restoranskog, suncokretovog ulja i butanola uz gvanidinski katalizator *N,N,N'*-tris(3-dimetilamino)propil gvanidin (GVK). Dobro je poznato da se u primjeni biodizel često namješta s mineralnim, naftnim dizelom u raznim omjerima. Prednost upotrebe butanola za proizvodnju biodizela je ta da za razliku od metanola i etanola zaostali butanol, u smjesama s naftnim dizelom neće uzrokovati narušavanje primjenskih svojstava dobivenog goriva (Rakopoulos i sur., 2010). Iako količinski ograničena, otpadna biljna ulja su jeftina sirovina i neće uzrokovati porast cijene hrane kao što može biti slučaj pri korištenju sirovih jestivih ulja. Upotreba otpadnih ulja savršeno se uklapa i u koncept kružne ekonomije prema kojoj bi se proizvodi osmišljavali tako da budu dio vrijednosne mreže unutar koje bi ponovna upotreba i prenamjena proizvoda (materijala) zajamčila trajnu reciklažu resursa. Dakle, cilj je smisliti proizvode tako da je unaprijed određen način uporabe konačnog otpada ili ostatka proizvoda. Upotrebom gvanidinskog katalizatora izbjegava se nastajanje nepoželjne saponifikacije koja se javlja pri upotrebi konvencionalnih baznih katalizatora kao što su KOH i NaOH. U ovom radu je korišten gvanidinski katalizator GVK (Glasovac et al., 2005) čija je visoka bazičnost ustanovljena 2008. mjerenjem vrijednosti pKa u acetonitrilu (Eckert-Maksić i sur., 2008). Sinteza biodizela iz otpadnog biljnog ulja i uglavnom metanola i etanola te uz konvencionalne katalizatore istražena je u više radova (Phan i sur., 2008, Chhetri i sur., 2008, Maneerung i sur., 2016)7. Također je u više radova istraživana i aktivnost gvanidinskih katalizatora za reakciju transesterifikacije ulja, ali ne i za butilne alkohole (Balbino i sur., 2011, Karavalakis i sur., 2011, Bromberg i sur., 2010).

Materijali i metode

Materijali

Kao osnovna sirovina za transesterifikaciju upotrebjeno je otpadno suncokretovo ulje (podaci za svježe ulje: $M = 876,45$ g/mol, Tena, Tvornica ulja Čepin) prikupljeno u restoranu Studentski centar Zagreb (Savska cesta 25). Prije upotrebe ulje je filtrirano kroz tekstilnu tkaninu da bi se uklonile krute nečistoće. Karakterizacijom po normiranim metodama ustanovljen je nizak sadržaj vode u ulju, 0,07 mas. % prema ASTM D 1123 i 0 mas. % prema HRN ISO 3734, kao i nizak kiselinski broj od 0,73 mg KOH/g određen prema HRN ISO 6618. Kao drugi reaktant korišten je *n*-butanol (p.a., Gram-Mol) s udjelom slobodnih masnih kiselina manjim od 0,0013 mas. % i udjelom vode manjim od 0,14 mas. %. Katalizator *N,N,N'*-tris(3-dimetilamino)propil gvanidin (GVK) sintetiziran je prema proceduri opisanoj u literaturi (Glasovac i sur., 2005), a njegova kemijska struktura prikazana je na slici 1.

Provedba pokusa i određivanje konverzije reakcije

Upotrebom programske podrške Design Expert izrađen je Box-Behnkenov plan pokusa odabirom četiri parametra (faktora) čiji se utjecaj istraživao na tri razine; temperatura: 40 – 60 – 80 °C, vrijeme reakcije: 1 – 2 – 3 h, omjer reaktanata, alkohola i ulja: 4 – 6 – 8 mol/mol i udio katalizatora: 1 – 2 – 3 mas. %. Ukupna masa reakcijske smjese iznosila je 15 g. Vrijeme se mjerilo od trenutka kada reakcijska smjesa dosegne zadanu temperaturu. Reakcijska je smjesa miješana magnetskom miješalicom. Konverzija reakcije određena je ¹H NMR spektroskopijom na uzorcima svih šarži (uskladišteni na -18 °C do provedbe mjerenja) po završetku provedenih pokusa. Uzorci su otopljeni u CDCl₃ i analizirani na uređaju NMR Bruker Avance pri 600 MHz.

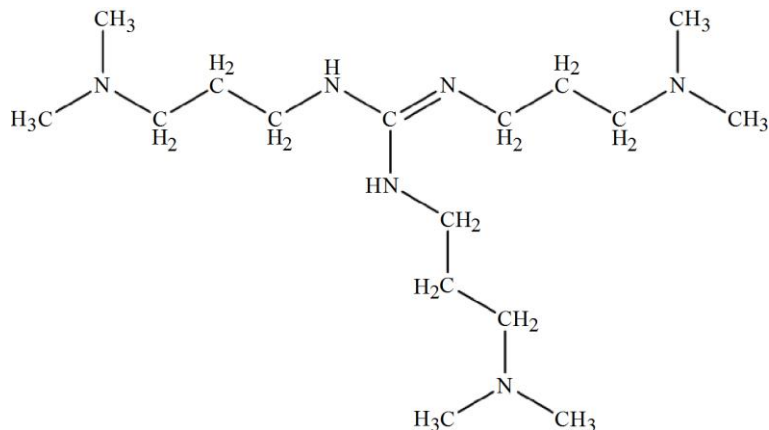

Slika 1. Struktura *N,N,N''*-tris(3-dimetilamino)propil gvanidina (GVK)
Fig. 1. Chemical structure of *N,N,N''*-tris(3-dimethylamino)propyl guanidine

Rezultati i rasprava

Provedeno je 30 eksperimenata transesterifikacije prema Box-Behnkenovu planu pokusa. Procesni uvjeti, skupa s konverzijama izračunatim iz NMR spektra, dani su Tablici 1. Na slici 2 a) prikazan je NMR spektar otpadnog suncokretovog ulja. Od interesa su signali s kemijskim pomacima 2,3 ppm (protoni u δ -položaju prema esterskoj skupini) i 2,8 ppm (protoni iz masnih kiselina između konjugiranih dvostrukih veza), a na slici b) i signal s kemijskim pomakom 4,0 ppm (protoni u butilnim esterima). Konverzija provedene transesterifikacije može se računati kao omjer površine signala (tripleta) skupine $-\text{OCH}_2$ ($\delta \approx 4,0$ ppm) i površine signala karakterističnog za dva protona pokraj karboksilne skupine koji predstavlja ukupni sadržaj masnih kiselina u obliku biodizela, slobodnih masnih kiselina, monoacilglicerola, diacilglicerola i triacilglicerola ($\delta \approx 2,3$ ppm). Problem je što signal s kemijskim pomakom od 2,3 ppm (Slika 2 b)), zbog njegove širine, mogu pojačati signali katalizatora pa se u pravilu na ovaj način dobiva manja konverzija od stvarne. Zbog toga, konverzija je izračunata preko signala $\delta \approx 2,8$ ppm (triplet) koji stvaraju protoni između konjugiranih dvostrukih veza ($=\text{CH}-\text{CH}_2-\text{CH}=\text{}$) estera linolne kiseline. Prvo je određen omjer signala $\delta \approx 2,8$ ppm i $\delta \approx 2,3$ ppm iz ulja (NMR spektar sa Slike 2 a)), a nakon toga je konverzija za svaki pokus računata pomoću tog omjera uz sljedeću formulu:

$$X_{exp} = 0,537 * \frac{P(\delta \approx 4,0 \text{ ppm})}{P(\delta \approx 2,8 \text{ ppm})}$$

gdje je 0,537 navedeni omjer iz nereagiranoeg otpadnog ulja, a P/P je omjer površina signala s pomacima 4,0 ppm i 2,8 ppm.

Kemijsko i biokemijsko inženjerstvo / Chemical and Biochemical Engineering

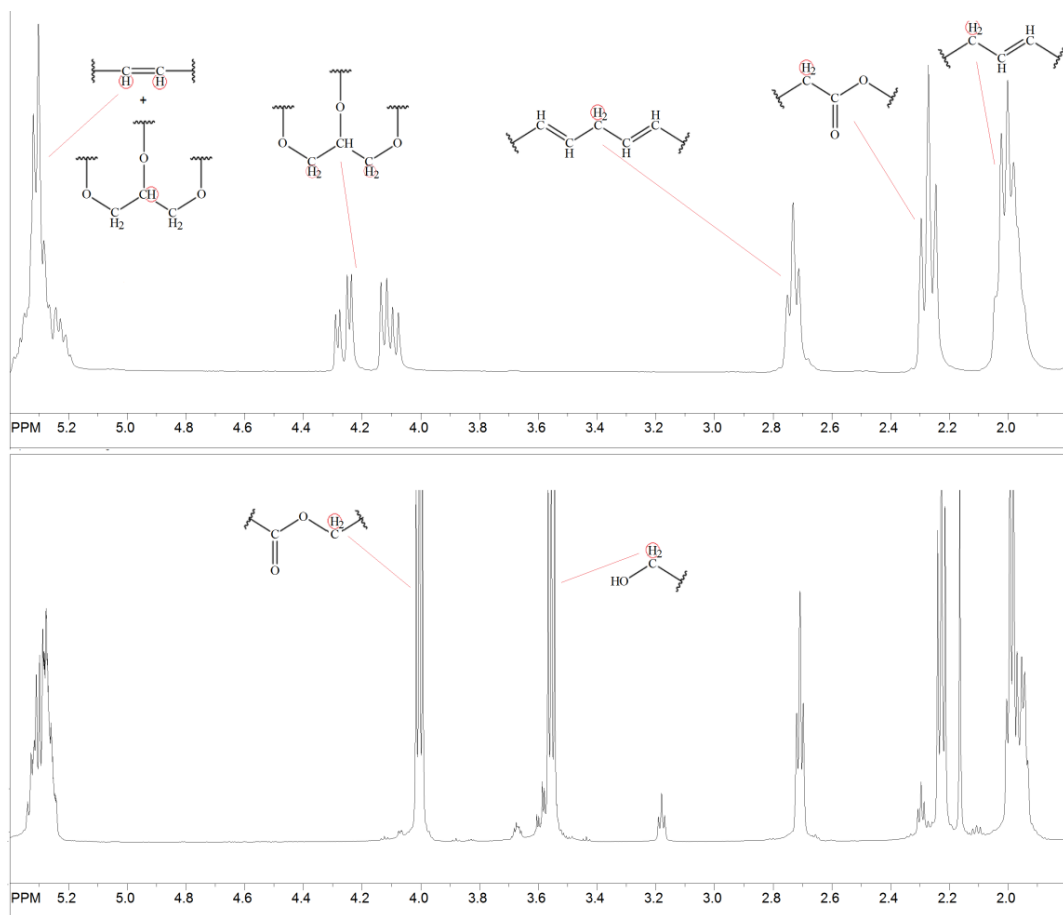

Slika 2. Dio NMR spektara otpadnog suncokretova ulja (a) i konačne reakcijske smjese eksperimenta broj 11 (b)

Fig. 2. Part of NMR spectra of used sunflower oil (a) and final reaction batch of experiment number 11 (b)

Na temelju dobivenih rezultata provedeno je modeliranje procesa s ciljem određivanja funkcijske međuovisnosti temperature (T), vremena reakcije (t), masenog udjela katalizatora (w_{kat}), molarnog omjera butanola i ulja (B/U) i konverzije transesterifikacije. Nakon odbacivanja jednog od centralnih eksperimenata (broj 8 iz Tablice 1), dobiven je statistički značajan model iskazan funkcijom polinoma drugog reda:

$$\begin{aligned}
 \text{konverzija} = & -315,3 + 3,50 * T + 43,9 * t + 50,7 * B/U + 89,8 * w_{kat} + 0,12 * T * t - 0,11 \\
 & * T * B/U - 0,19 * T * w_{kat} - 6,54 * t * B/U + 3,55 * t * w_{kat} - 1,875 * B/U \\
 & * w_{kat} - 0,027 * T^2 - 5,5 * t^2 - 2,05 * (B/U)^2 - 13,72 * w_{kat}^2
 \end{aligned}$$

Kemijsko i biokemijsko inženjerstvo / Chemical and Biochemical Engineering

Tablica 1. Popis pokusa s vrijednostima parametara i izračunatim konverzijama
Table 1. List of experiments with factor values and calculated conversions

Broj	$T, ^\circ\text{C}$	t, h	B/U, mol/mol	$w_{\text{kat}}, \%$	$P(4,0)/P(2,8)$	$X_{\text{eksp}}, \text{mol}\%$
1	80	2	4	2	1,1013	59,1
2	60	3	6	1	0,7940	42,6
3	60	2	6	2	1,4593	78,3
4	80	2	6	1	0,3341	17,9
5	40	2	8	2	1,5300	82,1
6	60	2	4	1	0,5462	29,3
7	40	3	6	2	1,4679	78,8
8	60	2	6	2	0,6889	37,0
9	60	1	4	2	0,9857	52,9
10	60	1	6	3	1,5342	82,4
11	40	2	6	3	1,6959	91,1
12	60	2	6	2	1,4515	77,9
13	40	1	6	2	1,5128	81,2
14	40	2	4	2	1,2058	64,7
15	60	3	6	3	1,5437	82,9
16	60	2	8	3	1,6932	90,9
17	60	1	8	2	1,5618	83,9
18	80	2	8	2	1,0978	58,9
19	40	2	6	1	0,8110	43,5
20	60	3	8	2	0,8214	44,1
21	80	1	6	2	1,0287	55,2
22	80	2	6	3	0,9380	50,4
23	60	2	6	2	1,6060	86,2
24	60	2	4	3	1,4971	80,4
25	60	3	4	2	1,2185	65,4
26	60	2	6	2	1,5557	83,5
27	80	3	6	2	1,1647	62,5
28	60	2	6	2	1,5780	84,7
29	60	1	6	1	1,0486	56,3
30	60	2	8	1	1,0208	54,8

Sa slike 4 vidljivo je da s povećanjem omjera B/U do vrijednosti od oko 7 pri istoj količini katalizatora raste konverzija. Visoke konverzije mogu se dobiti i za niske omjere butanola i ulja, ali uz veće količine katalizatora. Najveća konverzija postiže se pri omjeru B/U od oko 6,5 mol/mol i uz razmjerno visoki udio katalizatora od približno 2,75 mas. %. Na Slici 5 prikazana je odzivna površina na kojoj se mijenjaju vrijeme i maseni udio katalizatora, a druga dva parametra su na srednjim vrijednostima.

Utjecaj vremena gotovo je zanemariv u usporedbi s utjecajem koncentracije katalizatora. Kao što je i prije komentirano, konverzije preko 80 % dobivaju se već pri vremenu od 1 h i za udjele katalizatora veće od 2 mas. %.

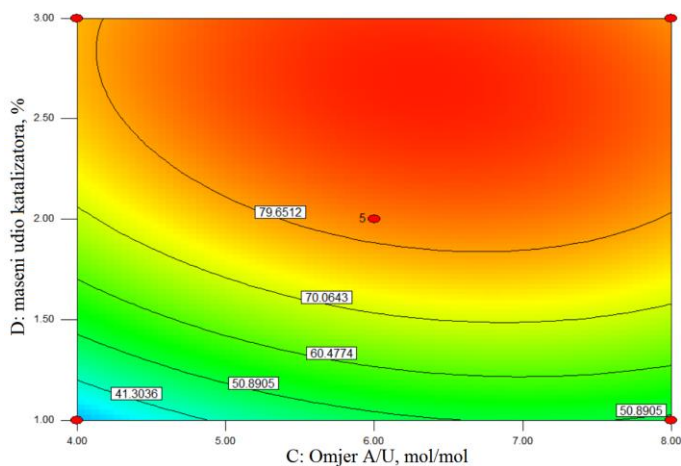

Slika 4. Ovisnost izračunate konverzije X_m o omjeru butanola i ulja (A/U) te udjelu katalizatora (temperatura je 60 °C, a vrijeme 2 h)

Fig. 4. Dependence of calculated conversion X_m on butanol to oil ratio (A/U) and catalyst concentration (temperature 60 °C, reaction time 2 h)

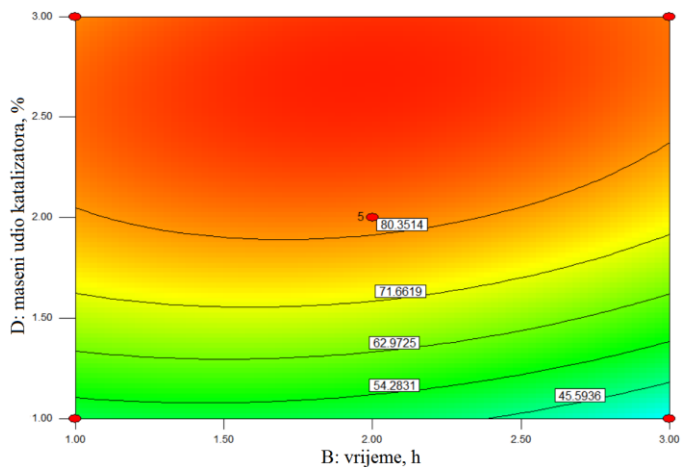

Slika 5. Ovisnost izračunate konverzije X_m o vremenu i udjelu katalizatora (temperatura je 60 °C, a omjer butanola i ulja 6:1)

Fig. 5. Dependence of calculated conversion X_m on reaction time and catalyst concentration (temperature 60 °C, butanol to oil ratio 6:1)

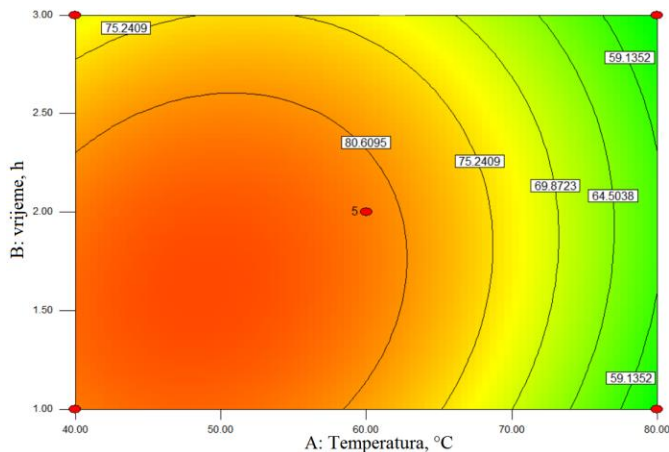

Slika 6. Ovisnost izračunate konverzije X_m o temperaturi i vremenu reakcije (omjer butanola i ulja je 6:1, a udio katalizatora 2 mas. %)

Fig. 6. Dependence of calculated conversion X_m on temperature and reaction time (butanol to oil ratio 6:1, catalyst concentration 2 wt. %)

Na Slici 6 prikazana je ovisnost konverzije o temperaturi i vremenu reakcije dok su druga dva ulazna parametra na srednjim vrijednostima. Općenito, povećanjem temperature raste brzina reakcije, ali će u egzotermnim reakcijama (poput transesterifikacije) povećanje temperature negativno utjecati na stanje ravnoteže. Prema Slici 6, vidljivo je da je negativan utjecaj povećanja temperature na ravnotežu reakcije veći od pozitivnog utjecaja na brzinu reakcije, pri istraženim uvjetima. Odnosno, brzina reakcije je razmjerno velika i pri temperaturi nižoj od 40 °C jer se postižu konverzije preko 80 % i to u razmjerno kratkom vremenu od 1 h. Najveća konverzija dobiva se pri temperaturi od oko 50 °C i vremenu reakcije od oko 1,5 h. Sa slike je također vidljivo da u istraženim rasponima vrijednosti, temperatura ima veći utjecaj na konverziju nego vrijeme.

Optimiranje reakcije transesterifikacije

Nakon što su analizirani konturni dijagrami izvedeni iz dobivenog empirijskog modela, provedeno je optimiranje procesa prema različitim funkcijama cilja čime je ujedno provjerena valjanost modela. Provedena su četiri pokusa kojima je cilj bio dobiti maksimalnu ili potpunu konverziju uz zadano ograničenje nekih od ulaznih faktora, na primjer smanjenje omjera B/U ili minimiziranje koncentracije katalizatora. Rezultati provedenog optimiranja dani su u Tablici 2.

Cilj pokusa Op1 i Op2 je postizanje što veće konverzije uz smanjenje količine katalizatora (Op1) ili smanjenje količine katalizatora i omjera butanol/ulje (Op2). Cilj pokusa Op3 bio je postići potpunu konverziju, bez ograničenja ulaznih faktora. Pokus Op4 osmišljen je za istraživanje reakcije u širem području vrijednosti omjera butanol/ulje i vremena reakcije uz uštedu katalizatora i s ciljem postizanja što veće konverzije. Naime, provođenjem reakcije u industrijskom mjerilu postoji mogućnost regeneracije i povrata butanola pa korištenje veće količine alkohola od stehiometrijske ne mora imati presudnu ulogu.

U tablici 2, faktor željenosti f označava podudaranje predviđenog pokusa (i predviđenih rezultata) sa zadanim važnostima ciljeva iz pojedine funkcije cilja (1 znači potpuno podudaranje predviđenog pokusa s funkcijom cilja, a 0 znači nepoklapanje).

Tablica 2. Teorijska (X_m) i eksperimentalna (X_{exp}) konverzija dobivena provedbom pokusa pri procesnim uvjetima izračunatima optimiranjem

Table 2. Theoretical (X_m) and experimental (X_{exp}) conversion obtained for reactions under optimized conditions

Pokus	T , °C	t , h	B/U, mol/mol	w_{kat} , mas. %	X_m , mol. %	f	X_{exp} , mol. %
Op1	45,7	1,00	8,00	1,26	78,8	0,80	67,3
Op2	54,0	2,49	4,54	1,86	73,1	0,64	71,1
Op3	47,6	1,01	8,65	2,33	100,0	1,00	86,1
Op4	40,5	0,50	9,82	1,38	92,4	0,87	84,9

Eksperimentalno dobivene konverzije provedenih pokusa su manje od predviđenih, osim za pokus Op2 gdje je dobiveno dobro slaganje. U tom slučaju dobivena je konverzija od oko 71 mol. % (u planu pokusa ostvarene su konverzije i veće od 90 mol. %, ali uz visoki udjel katalizatora od 3 mas. %), uz određenu uštedu butanola i katalizatora i uz nešto dulje vrijeme reakcije. U pokusu Op3, u kojem je predviđeno dobivanje potpune konverzije uz ekstrapolaciju utjecaja omjera butanola i ulja, ostvarena je najveća konverzija iz ovog seta pokusa što znači da je pogođen trend ponašanja konverzije. Konverzija dobivena u pokusu Op4 je također razmjerno blizu predviđenoj vrijednosti čime je potvrđeno da se visoke konverzije mogu dobiti za kratko vrijeme reakcije od 30 min, pri temperaturi na donjoj granici istraženog područja te uz vrlo malu količinu katalizatora, ali je pri tome nužan visoki omjer butanol/ulje.

Zaključci

Za sintezu biodizela korišteno je otpadno restoransko ulje za koje se pokazalo da ima visoku kvalitetu s obzirom na ključne parametre (sadržaj vode i kiselinski broj, to jest sadržaj slobodnih masnih kiselina) i *n*-butanol. Kao katalizator za transesterifikaciju ulja korišten je novi gvanidinski katalizator za koji je u prethodnim istraživanjima (Racar, 2015) utvrđeno da ima visoku aktivnost za reakciju ulja s nižim alkoholima. U programskom paketu Design Expert izrađen je Box-Behnkenov plan pokusa prema kojem su se četiri najvažnija reakcijska parametra (temperatura, vrijeme, maseni udio katalizatora, molarni omjer reaktanata) varirala na tri razine kodiranih vrijednosti -1, 0 i 1. Primjenom NMR analize dobiveni su rezultati koji upućuju na to da količina katalizatora ima najveći utjecaj na konverziju reakcije, a najmanji utjecaj ima vrijeme reakcije. Pomoću dobivenog empirijskog modela, a uz različite funkcije cilja, provedena su četiri dodatna pokusa koji su potvrdili valjanost modela u smislu predviđanja trenda kretanja konverzije, ali su u stvarnosti dobivene konverzije manje od onih predviđenih modelom. Najbliže rezultate pokazao je pokus (Op4) u kojemu je cilj bio ostvariti potpunu konverziju uz uštedu katalizatora s faktorom važnosti 3,

Kemijsko i biokemijsko inženjerstvo / Chemical and Biochemical Engineering

a dopušteno je ekstrapoliranje temperature, vremena i omjera butanola i ulja. Za (Op4) predviđena je konverzija od 92,4 mol. % na temperaturi 40,5 °C, u vremenu 30 min, s omjerom butanola i ulja 9,82 mol/mol i masenim udjelom katalizatora od 1,4 mas. %. Eksperimentalno je dobivena konverzija od 84,9 mol. %. Za poboljšanje procesa, osim odabira optimalnih parametara, potrebno je i razdvajati tvari iz završne reakcijske smjese i regenerirati nereagirane reaktante (posebice butanol ako se dodaje u velikom suvišku).

Literatura

- Balbino J. M., Menezes E. W., Benvenuti E. V., Cataluna R., Ebeling G., Dupont J. (2011): Silica-supported guanidine catalyst for continuous flow biodiesel production, *Green Chem.* 13, 3111-3116.
- Bromberg L., Fasoli E., Alvarez M., Hatton T. A., Barletta G. L. (2010): Biguanide-imine- and guanidine-based networks as catalysts for transesterification of vegetable oil, *React. Funct. Polym.* 70, 433-441.
- Chhetri A. B., Watts K. C., Islam M. R. (2008): Waste Cooking Oil as an Alternative Feedstock for Biodiesel Production, *Energies* 1, 3-18.
- Eckert-Maksić M., Glasovac Z., Trošelj P., Kütt A., Rodima T., Koppel I., Koppel I. A. (2008): Basicity of Guanidines with Heteroalkyl Side Chains in Acetonitrile, *Eur. J. Org. Chem.* 5176-5184.
- Glasovac Z., Kovačević B., Meštrović E., Eckert-Maksić M. (2005): Synthesis and properties of novel guanidine bases. *N,N,N'*-Tris(3-dimethylamino-propyl)-guanidine, *Tetrahedron Lett.* 46, (50) 8733-8736.
- Kiš D., Jurić T., Emert R., Plašćak I. (2006): Alternativno gorivo – biodizel, *Agriculture* 12, 41-46.
- Karavalakis G., Anastopoulos G., Stournas S. (2011): Tetramethylguanidine as an efficient catalyst for transesterification of waste frying oils, *Appl. Energy* 88, 3645-3650.
- Maneerung T., Kwai S., Dai Y., Wang C. H. (2016): Sustainable biodiesel production via transesterification of waste cooking oil by using CaO catalysts prepared from chicken manure, *Energ. Convers. Manage.* 123, 487-497.
- Phan, N., Phan Tan M. (2008): Biodiesel production from waste cooking oil, *Fuel* 87, 3490-3496.
- Racar M. (2015): Optimiranje procesa proizvodnje biodizela iz otpadnih ulja upotrebom novih gvanidinskih katalizatora, diplomski rad, Fakultet kemijskog inženjerstva i tehnologije Sveučilišta u Zagrebu, Zagreb.
- Rakopoulos D. C., Rakopolos C. D., Giakoumis E. G., Dimaratos A. M., Kyristis D. C. (2010): Effects of butanol-diesel fuel blends on the performance and emissions of a high-speed DI diesel engine, *Energ. Convers. Manage.* 51, 1989-1997.
- Sinčić D. (2009): Biodizel: Svojstva i tehnologije proizvodnje, *Kem. Ind.* 58, 97-98.
- Wörgetter, M. (1991): Pilotprojekt Biodisel, *Forschungsberichte der Bundesanstalt für Landtechnik*, Weiselburg, 26.
- ASTM D 1123 Standard Test Methods for Water in Engine Coolant Concentrate by the Karl Fischer Reagent Method.
- HRN ISO 3734 Određivanje vode i sedimenata u ostatku loživih ulja – Metoda centrifuge.
- HRN ISO 6618 Determination of acid and base number – Colour-indicator titration method.

Original research paper

Biodiesel synthesis from waste sunflower oil and butanol by using guanidine catalyst

Stjepan Džalto¹, Fabio Faraguna¹, Zoran Glasovac², Ante Jukić^{1*}

¹*University of Zagreb, Faculty of Chemical Engineering and Technology,
Marulićev trg 19, 10000 Zagreb, Croatia*

²*Ruđer Bošković Institute, Bijenička cesta 54, 10000 Zagreb, Croatia*

**Corresponding author: ajukic@fkit.hr*

Summary

Great demands on world's limited supplies of raw materials have induced the development of circular economy. It is a concept where products would be made a part of a network in which reuse and redevelopment of products and materials would guarantee permanent recycling of resources. Recycling of waste vegetable oils is a part of that concept. In this paper, synthesis of biodiesel from waste restaurant oil and *n*-butanol with *N,N,N'*-tris(3-dimethylamino)propyl guanidine as catalyst is described. Advantage of guanidine over conventional base catalysts is avoidance of undesirable saponification process, in presence of water, while retaining high catalyst activity. Influence of most important process factors, temperature, time, mass fraction of catalyst and butanol to oil molar ratio, on conversion rate for biodiesel production has been investigated using Design of Experiments and factor analysis. Conversion rate has been determined by using NMR spectroscopy. An empirical model, for prediction of conversion rate for any combination of input factors, has been created. The model was validated by different objective functions in which the aim was to obtain high conversion rate with the lowest amount of catalyst. For one of objective functions, optimal factors were: temperature 40.5 °C, time 30 min, molar ratio of reactants 9.8 mol/mol and catalyst mass fraction 1.4 % with predicted conversion rate of 92.4 %. Experimentally determined conversion rate for that combination of factors was 84.9 %.

Keywords: biodiesel, waste vegetable oil, butanol, transesterification, guanidine catalyst

Original research paper

Comparison of the powder and monolithic Mn-Ni catalyst in toluene combustion

Kristina Babić*, Marina Duplančić, Vesna Tomašić, Nikola Milosavljević, Ana Peršić

*University of Zagreb, Faculty of Chemical Engineering and Technology,
Department of Reaction Engineering and Catalysis, Marulićev trg 19, 10000, Zagreb, Croatia*

**Corresponding author: kbabic@fkit.hr*

Summary

One of the major air pollutants that give rise to harmful health and environmental effects are volatile organic compounds (VOCs) emitted from many of anthropogenic sources. Among existing destructive VOCs removal methods, catalytic combustion is the most convenient one due to low reaction temperatures that lead to lower NO_x and CO emissions. Catalysts usually used in this process are supported or unsupported noble metals and transition metal oxides or their combinations. Recently, many efforts have been made on the utilization of the low-cost and environment-friendly raw materials, such as manganese oxide combined with nickel, which have been investigated in this research. In this study toluene has been chosen as a representative volatile organic compound, since it contains aromatic ring which cannot be easily degraded.

Catalysts based on the mixed manganese oxides were synthesized by the co-precipitation method and characterized using different instrumental techniques (such as DSC, FTIR, SEM, etc.) Monolithic Mn-Ni catalyst was prepared using the washcoating method. Catalytic combustion of toluene was carried out both in the fixed bed reactor (catalyst in the powder form) and in the metallic monolith reactor. Reaction was performed at different reaction temperatures and different total flow rates of the reaction mixture (23-100 cm³/min). It was revealed that the manganese-nickel mixed oxide catalysts show good catalytic activity, achieving a complete oxidation of toluene in the temperature range of 230-350 °C, depending on the space time inside the reactor, toluene inlet concentration and the type of catalyst used.

Keywords: VOC, toluene combustion, Mn-Ni oxides, metallic monolith

Introduction

Volatile organic compounds attracted great attention of researchers in the field of environmental protection, because of their high toxicity contribution to the air, water and soil pollution, as well as due to their participation in the emergence of the greenhouse effect, acid rain formation and the destruction of stratospheric ozone. A majority of VOCs emissions are result of anthropogenic activities, such as fuel combustion, industrial processes, non and on-road vehicles (Ihm, 2000). When there is no interest in recovering VOCs, they are usually destroyed by catalytic oxidation, which is more preferable than thermal one, due to lower reaction temperatures that lead to lower NO_x and CO emissions.

In the commercial combustion processes, noble metal catalysts (mainly Pt and Pd) are mostly used, because of their high activity and good stability. In terms of economical and practical consideration, other materials that present alternative to noble metals, have been studied. Among examined catalytic materials, catalysts based on transition metal oxides (such as Ni, Co, Cu, Cr, Mn and Fe) showed good activity in comparison to noble metals. Besides, they are less expensive and less sensitive to poisoning (Huang et al., 2016; Andersson et al., 1996; Bernier et al., 1998). The single oxide of MnO_x was proved to exhibit high activity in VOCs conversion, which can be attributed to the capability of manganese to form oxides with different oxidation states and to their oxygen storage capacity (Armaroli et al., 1999).

In an attempt to develop more efficient catalyst formulations for VOCs combustion, many investigations were focused on the study of catalytic performance of binary mixtures of different transition metal oxides (Barbero et al., 2006, 2007; Banu et al., 2015; Jiang et al., 2009). For instance, catalytic activity of a series of binary mixtures of copper, manganese and cerium oxides supported on high surface area $\gamma\text{-Al}_2\text{O}_3$ for toluene oxidation has been studied in comparison with the corresponding single metal oxide components. Optimal results were obtained for 10 CuO-60 MnO, 30 MnO-50 CeO₂ and 15 CuO-75 CeO₂ catalysts (e.g. 10 CuO-60 MnO refers to a catalyst consisting of 10% of CuO, 60% of MnO and 30% of Al₂O₃, by weight), with complete oxidation at temperatures around 280 °C, i.e., considerably lower than those of the corresponding single oxide catalysts (Kondarides et al., 2011). The obtained results reveal that the improved performance of mixed oxide catalysts is not due to formation of solid solutions or new mixed-oxide phases, but due to facile spreading of one M_xO_y species onto the other, which results in materials with increased surface area. Another example of the improved catalytic activity of combined metal oxides in comparison to single ones are manganese copper mixed oxide catalysts (Mn-Cu, respectively), prepared by co-precipitation varying the aging time for 4, 18 and 24h (Barbero et al., 2006). These catalysts showed better catalytic performance in propane and ethanol total oxidation than Mn₂O₃ and CuO pure oxides (prepared by the same method as Mn-Cu catalysts), respectively. It was also found that the increase of the aging time increased the catalytic activity and the selectivity to CO₂. The same trend was shown in the catalytic evaluation in ethanol and propane combustion over Mn-Ni, Mn-Fe and their pure oxides (Barbero et al., 2007). In order to apply these alternative catalysts in catalytic combustion of VOCs at the industrial level, they should be deposited on a structured support that allows treating large gas flows under the low pressure drop. The most popular structured supports used in the practice are ceramic or metallic monoliths.

Monolithic catalysts and/or reactors are representatives of the system in which common differences between a catalyst and a reactor disappear relevant to the micro and meso-scale level (Jović et al., 2006). The largest application of the monoliths is in the automotive industry for the cleanup of exhaust gases. Other widespread applications are the selective catalytic reduction of off-gases of the power stations and the ozone destruction in airplanes (Beers et al., 2001). Also, many researchers consider the application of monoliths as a replacement for a conventional reactor in multi-phase reactions (Hoek et al., 2004; Heiszwolf et al., 1999). As we know, till now there is only one example of the large-scale industrial application of monolithic catalysts in a multiphase process - the production of hydrogen peroxide using the anthraquinone process.

Recently, metallic monoliths have become very popular due to their high thermal conductivities, lower heat capacities, greater thermal and mechanical shock resistance and smaller wall thickness,

allowing the higher cell density and lower pressure drop than ceramic ones (Avila et al., 2005). Different metals and alloys are investigated for the manufacture of monolithic structures in the search for mechanical, chemical and thermal stability and availability in thin foils, e.g. Ni-Cr alloys, AISI 304 stainless steel, ferritic steel containing alumina (FeCrAlloy[®]) and aluminum coated by Al₂O₃ produced by anodization (Barbero et al., 2011). There are few well-developed procedures for coating of the active phase on the metallic monolithic support, for instance ion-exchange, homogeneous deposition-precipitation, impregnation and washcoating, which were explained in detail by Beers et al. (2001). In the study of Burgos et al. (2000) Al/Al₂O₃ monoliths impregnated with noble metal (Pt or Pd) have been evaluated in the catalytic oxidation of toluene. The resulting impregnated monoliths have shown high activity in the complete oxidation of toluene, even higher than the same catalyst supported on powder Al₂O₃. Considering that transition metal oxides are a more economical alternative, and, moreover, they demonstrated excellent catalytic behavior in oxidation reactions, the aim of this work was to develop an optimized Mn-Ni catalyst on a metallic monolith support by means of washcoating. Monolithic catalyst was then compared to Mn-Ni catalyst in powder form in the catalytic oxidation of toluene and obtained results were compared and discussed.

Materials and Methods

The preparation procedures for powder and monolithic Mn-Ni oxide catalysts, together with instrumental techniques applied for catalyst characterization were presented. Also, experimental set-up and method of toluene determination were described.

Catalyst preparation

The powder catalyst was synthesized by the co-precipitation method using a similar procedure as described in the literature (Barbero et al., 2007; Habibi et al., 2003). Aqueous solutions of Ni(NO₃)₂·6H₂O (0.25 M) and Mn(NO₃)₂·4H₂O (0.25 M) were prepared and stirred for 5 min. The Mn/Ni atomic ratio was equal to 1. Aqueous Na₂CO₃ (first 1 M, then 0.25 M) was added to stirred nitrate solution, while the temperature was maintained within the range of 25-30 °C until, pH of 8.4 was achieved. The obtained precipitate was then left in this medium for 24 h. Then it was filtered, washed several times with distilled water and dried at 120 °C for 12 h obtaining the precursor. At the end, the precipitate was calcined at 250 °C (2 h) and 500 °C (3 h) to give the final catalyst. The powder material was then pressed under the pressure of 6x10⁶ Pa, gently crushed and sieved to obtain particles of 0.315-0.400 mm diameter.

The monoliths were prepared from thin foils of Al/Al₂O₃ (0.145 mm thickness), both sides anodized in oxalic acid at 40 °C. Anodized foils were donated from metallurgical industry Cinkarna, Slovenia. The monolithic structures were made by rolling around a spindle crimped foil. The monoliths (4 cm long and 0.6 cm of diameter) were then treated with 65 wt% HNO₃ in order to eliminate impurities and washed with distilled water. Then they were dried at 120 °C for 1 h and calcined at 500 °C for 2 h. Monolithic structures were dipped in a solution containing Ni(NO₃)₂·6H₂O, Mn(NO₃)₂·4H₂O and citric acid for 30 minutes. Afterwards, they were dried at 120 °C for 1 h and calcined at 500 °C for 2 h. The preparation procedure is a modification of the procedure reported in the literature (Barbero et al., 2008).

Catalyst characterization

Characterization of the powder catalysts included nitrogen adsorption-desorption analysis, differential scanning calorimetry (DSC), scanning electron microscopy (SEM) with energy dispersive X-ray (EDX) analysis and Fourier-transform infrared spectroscopy (FTIR).

Nitrogen adsorption and desorption isotherms were determined at -196 °C by means of ASAP-2000 analyzer (Micrometrics Inc.), from which surface area, the pore volume and pore diameter were determined, based on the Brunauer-Emmet-Teller (BET) model.

The morphology of the powder catalyst sample was examined with a SEM Tescan Vega III Easyprobe. This instrument is fully integrated with EDX microanalyser for automatic quantitative elemental analysis.

DSC analysis of the powder catalyst after the preparation and thermal treatment (drying at 120 °C) was performed on the Mettler Toledo DSC 823^c instrument, based on the well proven Boersma or heat flux principle. The analysis was carried out in the temperature range from 25 to 550 °C, at the heating rate of 10 °C/min in an inert atmosphere of N₂ stream (50 cm³/min).

FTIR spectra of the powder catalyst before and after the reaction were registered using a PerkinElmer[®] Spectrum One spectrometer at the room temperature in a wavelength range from 600 to 4000 1/cm.

Catalytic tests

Mixed Mn-Ni oxide catalysts (mass of the powder catalyst was 0.3 g; mass of the active component in the monolithic form was 0.0035 g) were evaluated in the toluene combustion under atmospheric pressure. The reactor system consisted of tubular stainless steel fixed-bed reactor (inner diameter was 8 mm), located in a vertical quartz furnace, whose temperature was regulated by a proportional-integral-derivative (PID) thermo-controller (TC208 Series). The catalyst was loaded into the reactor between two quartz wool plugs in order to achieve a uniform gas flow across the catalytic bed. The reaction temperature was recorded with a K-type thermocouple, placed in the centre of the reactor. The vapor toluene was achieved using two approaches: a) by bubbling a stream of helium (He) through a saturator containing liquid toluene and b) using a gaseous mixture of toluene in nitrogen (inlet toluene concentration in nitrogen was 243 ppm). In the first case, a stream of He saturated with toluene was further diluted with synthetic air (oxidant).

A schematic illustration of the apparatus in the system with a saturator is presented in Fig. 1. The feed mixture was controlled using the mass flow controllers (MFC) (Brooks). The gaseous mixture was analyzed before and after reaction by gas chromatography (GC) *on-line* using a GC-2014 chromatograph (Shimadzu), equipped with flame ionization detector (FID). The conditions of the chromatographic analysis are described in Table 1. The data reported at each reaction temperature and the total flow rate were the average of three measurements at the steady-state conditions. The catalyst activity for toluene oxidation was evaluated by conversion of toluene, calculated as a function of the reaction temperature from the concentration of toluene at the inlet and outlet of the reactor, i.e., $(c(\text{toluene})_{\text{inlet}} - c(\text{toluene})_{\text{outlet}})/c(\text{toluene})_{\text{inlet}}$. Inlet concentration of toluene in the reaction mixture was constant.

Reaction conditions used in the toluene combustion for powder and monolithic catalysts are presented in Table 2.

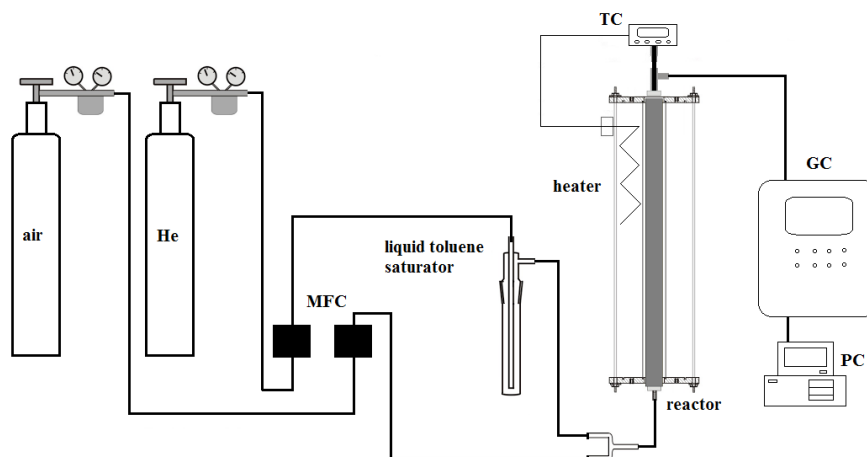

Fig. 1. Schematic illustration of the apparatus

Table 1. The conditions of the chromatographic analysis

GC/FID	Shimadzu 2014
Column	Carbowax 20M
Filler dimensions (μm)	250/177
Loop volume (cm^3)	0.5
Carrier gas	N_2
Detector temperature ($^\circ\text{C}$)	250
Column temperature ($^\circ\text{C}$)	120

Table 2. Reaction conditions

Variable	Value		
	Powder	Monolith 1	Monolith 2
Toluene concentration (ppm)	18000	20000	48-233
Pressure (Pa)		101325	
Temperature ($^\circ\text{C}$)		100-380	
Total flow rate (cm^3/min)		23-100	
Catalyst mass (g)	0.3	0.0035	0.0025

Preliminary results obtained from the combustion tests over a monolithic catalyst (monolith 1) evidenced that its activity is comparable to the activity of powder catalyst. To make further investigations, second monolithic catalyst (monolith 2) was prepared by the same procedure and tested in toluene combustion using a much lower inlet concentration of toluene. To examine the adaptability of the monolithic catalyst to the operating conditions, the toluene combustion was performed at different space times in the reactor and at different feed gas concentrations. Space time in the reactor was varied by changing total flow rates of the reaction mixture at the constant mass (or volume) of catalyst.

Results and Discussion

Catalysts based on the mixed Mn-Ni oxides were synthesized by the co-precipitation and washcoating method and characterized using different instrumental techniques. These catalysts were evaluated for toluene combustion performed in the fixed bed reactor.

Catalyst characterization

The chemical composition of the catalyst sample, estimated by EDX analysis and the physicochemical properties (specific surface area S_{BET} , pore volume V_{PORE} and pore diameter d), determined by N_2 adsorption-desorption analysis are reported in Table 3. It was shown that powder Mn-Ni catalyst possess a specific surface area of $38.4 \text{ m}^2/\text{g}$, which is similar to the value reported in the literature (Barbero et al., 2007). Based on the determined value of average pore diameter of approx. 20 nm, in terms of IUPAC standards, the catalyst can be classified in the group of mesoporous catalytic materials. The results of EDX analysis confirmed expected Mn/Ni atomic ratio. The SEM image of the prepared Mn-Ni catalyst is shown in Fig. 2. It can be seen that the surface of the catalyst consists mainly of spherical clusters with cca. 2 μm size. The FT-IR spectra of the catalyst before and after performing the reaction is shown in Fig. 3. Comparison of the spectra of the fresh catalyst and catalyst after the reaction showed the absence of changes in the catalyst structure which could arise due to a by-product adsorption to the catalyst surface during the reaction. Results of the DSC analysis (Fig. 4.) showed first endothermic peak in the temperature range from 50 to 100 $^\circ\text{C}$, corresponding to water desorption, and second endothermic peak from 255 to 313 $^\circ\text{C}$, which indicates a significant change in the crystal structure of the catalyst. To prevent the influence of the crystal structure change on the catalytic activity during toluene oxidation, catalyst has been calcined at 500 $^\circ\text{C}$ for 3 h, after which these peaks have not been found on a DSC spectra.

Table 3. Physicochemical properties of the prepared powder Mn-Ni catalyst

Catalyst	$S_{\text{BET}}^{\text{a}}$ (m^2/g)	$V_{\text{PORE}}^{\text{a}}$ (m^3/g)	d^{a} (nm)	Weight atomic ratio ^b (%)		
				Mn	Ni	O
Mn-Ni	38.4	0.1956	20.3752	40	36.1	14.2

^aDetermined from the N_2 adsorption-desorption isotherms

^bDetermined from spectrometric analysis (EDX)

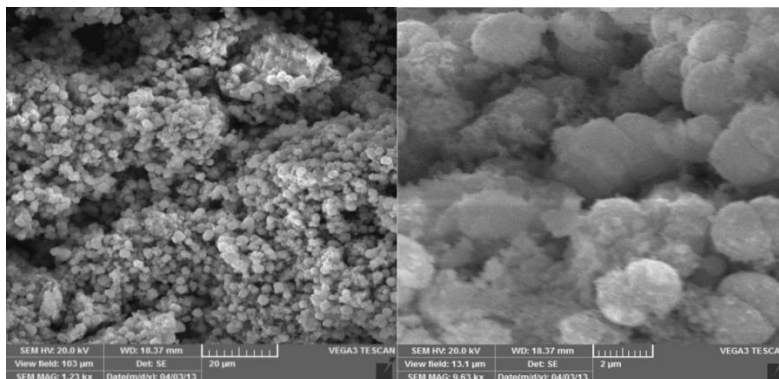

Fig. 2. SEM images of powder Mn-Ni catalyst

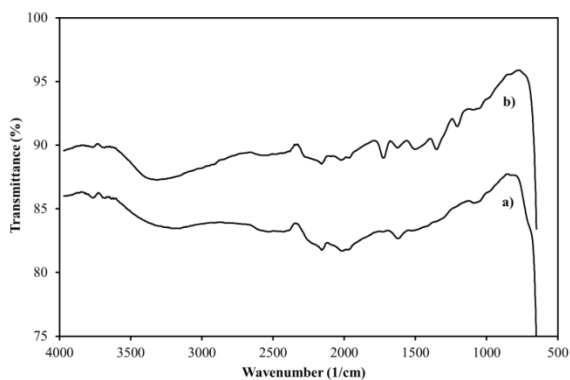

Fig. 3. FT-IR spectra of the sample catalyst: a) before reaction, b) after reaction

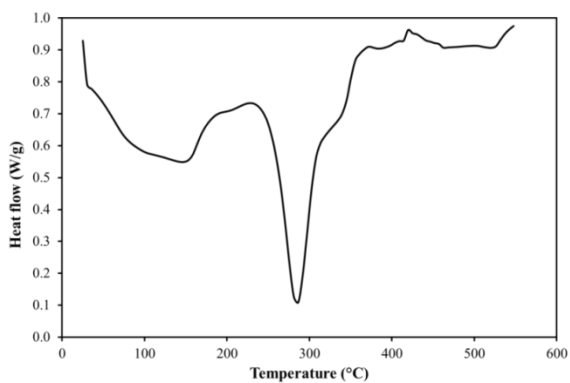

Fig. 4. Results of DSC analysis of the powder catalyst sample

Catalytic testing of the powder catalyst

A simplified mechanism for toluene oxidation is shown in Fig. 5. It is known from earlier studies (Liu et al., 2004; Boikov et al., 2008) that possible products during partial toluene oxidation are benzaldehyde, benzoic acid, maleic anhydride and carbon oxides. While the reaction products could not be analyzed by gas chromatography, the conversion was calculated based on toluene consumption. Catalytic tests for toluene oxidation over powder Mn-Ni catalyst were performed at different total flow rates (25-100 cm³/min) and in the temperature range of 150 to 350 °C. The obtained light-off curves as a function of reaction temperature are shown in Fig. 6. Contrary to the theoretical expectations, the increase of the space time at the same temperature resulted in decreasing of toluene conversion, except at a temperature of 200 °C. This can be explained by the temperature variations and incomplete saturation of He with toluene, especially when experiments were performed at the greater flow rates of toluene. Taking this into account, probably the influence of the space time on the toluene concentration before entering the reactor, and thus, toluene conversion inside the reactor, was greater in the saturator system than inside the reactor. To avoid such unexpected results all additional experiment were performed using a bottle containing a mixture of toluene in nitrogen with a known inlet toluene concentration. However, based on preliminary results it was evident that under reaction conditions employed in this study the conversion of toluene started at approximately 170 °C and was completed below 350 °C.

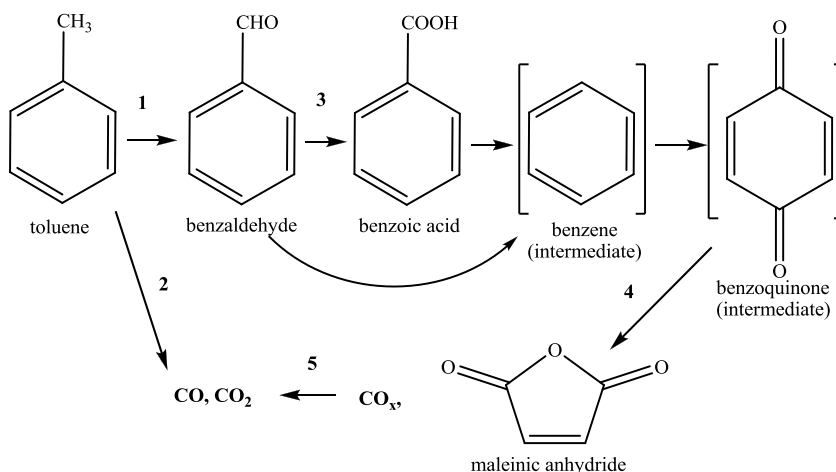

Fig. 5. Reaction of toluene oxidation with possible products and by-products

Powder vs. monolithic catalyst

The activity of powder and monolithic catalyst based on the mixed Mn-Ni oxide was compared in toluene combustion at a total flow rate of 25 cm³/min and at temperatures ranging from 170 to 380 °C. In Fig. 7., it can be observed that monolithic catalyst (monolith 1) showed similar, at some temperatures even better catalytic performance in comparison to the powder one. Taking into account that the mass of the catalytically active phase deposited on a monolithic support was almost

Kemijsko i biokemijsko inženjerstvo / Chemical and Biochemical Engineering

100 times less than the corresponding mass in the powder catalyst, a small difference in their catalytic behavior becomes very significant. The obtained results for powder Mn-Ni catalyst were comparable to similar results reported in the literature (Barbero at al., 2007). These researchers have used manganese nickel mixed oxide catalysts, $MnNi_x$ as well as NiO and Mn_2O_3 pure oxides in the combustion of propane, selected as model volatile organic compound. In their work complete conversion of propane was observed at a temperature of cca. 320 °C, while the temperature of 100 % toluene conversion was 370 °C. Taking into account that toluene contains an aromatic ring, which is hardly degradable, it can be concluded that the activity of Mn-Ni mixed oxide catalyst is quite similar for both volatile organic compounds. Furthermore, after performing catalytic tests at high conversions over both, powder and monolithic catalyst for a longer time, no deactivation was observed, showing the high stability of these transition-metal oxide catalysts. It is known, that in commercial applications, catalytic stability as well as activity is a very important factor. Based on the basis presented so far, it was decided to evaluate the catalytic behavior of the second monolith sample (monolith 2) in the toluene combustion, using a much lower inlet toluene concentration and avoiding experimental problems associated with achieving the desired toluene concentration before entering the reactor. In the following experiments the influence of the space time and inlet concentration of toluene at different total flow rates and reaction temperatures on toluene conversion was examined in more details.

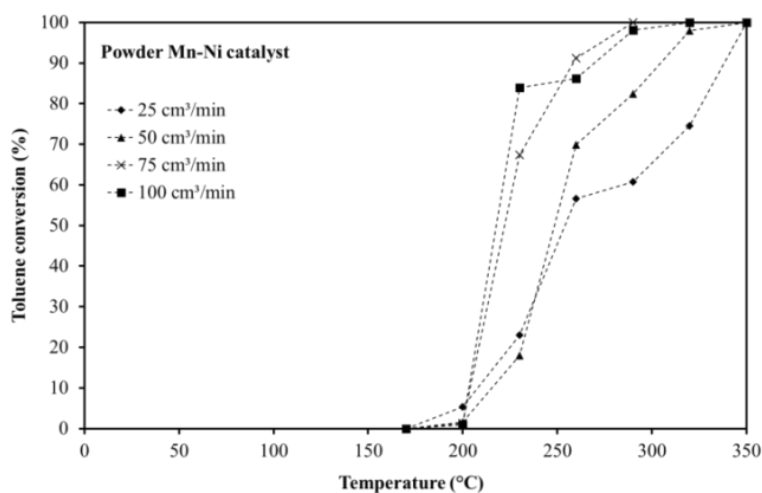

Fig. 6. Conversion of toluene over mixed Mn-Ni oxide powder catalyst as a function of temperature and space time inside the reactor ($m_{\text{catalyst}}=0.3$ g)

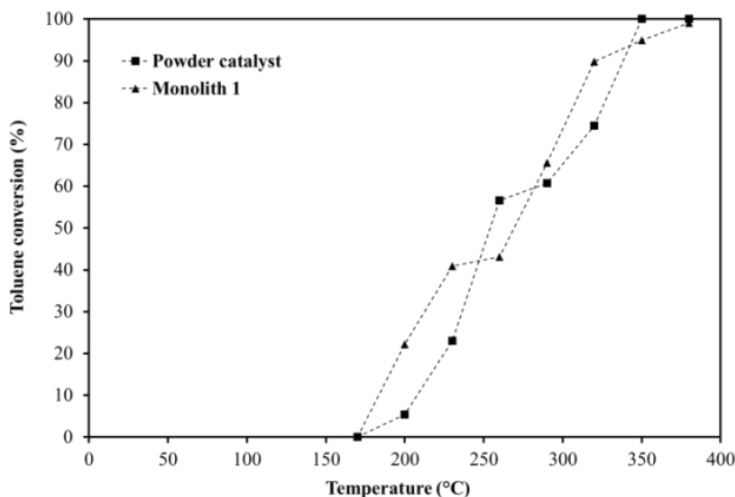

Fig. 7. Comparison of the results obtained for toluene combustion using the fixed bed reactor and metallic monolith reactor

Effect of the space time

The reaction of toluene oxidation was performed at different total flow rates, different temperatures and at constant inlet toluene concentration (210.43 ppm in N₂), as well as at the constant volumetric ratio of toluene/N₂ and air (20:3). As it can be seen in Fig. 8., an increase in the total gas flow rate results in a decrease of the toluene conversion due to a significant decrease in the contact time between the reactants and catalyst. This is particularly evident at 175 and 200 °C, while the complete oxidation of toluene is achieved at only 230 °C for a whole range of the total flow rates employed during this investigation. Similar results were reported by Li et al. (2012) in the toluene oxidation over metallic monolith catalysts based on noble metals, e.g. Pd/FeCrAl. Obviously, metallic monoliths containing Mn-Ni mixed oxide as a catalytically active component may be used as a suitable substitute for the more expensive catalysts based on noble metals.

Effect of the inlet toluene concentration

Further catalytic experiments have been performed at different inlet toluene concentration (48.4-193.6 ppm). The inlet toluene concentration has been changed by diluting the reaction mixture at the constant volumetric ratio of the reaction mixture and oxidant (20:3) with a stream of N₂ to achieve the total volumetric flow rate of 100 cm³/min. Fig. 9. shows the influence of the inlet toluene concentration on toluene conversion at different temperatures and at a constant total flow rate of reaction mixture. It can be seen that the increase of the inlet toluene concentration at the same temperature results in the higher toluene conversion. This can be explained by the fact that the catalyst surface is more covered with molecules of the reactant, and thus, a greater amount of molecules is active in the oxidation reaction when higher toluene concentrations are used.

Kemijsko i biokemijsko inženjerstvo / Chemical and Biochemical Engineering

Again, the increase in temperature at a constant toluene concentration has a significant influence on the conversion which is in line with our expectations.

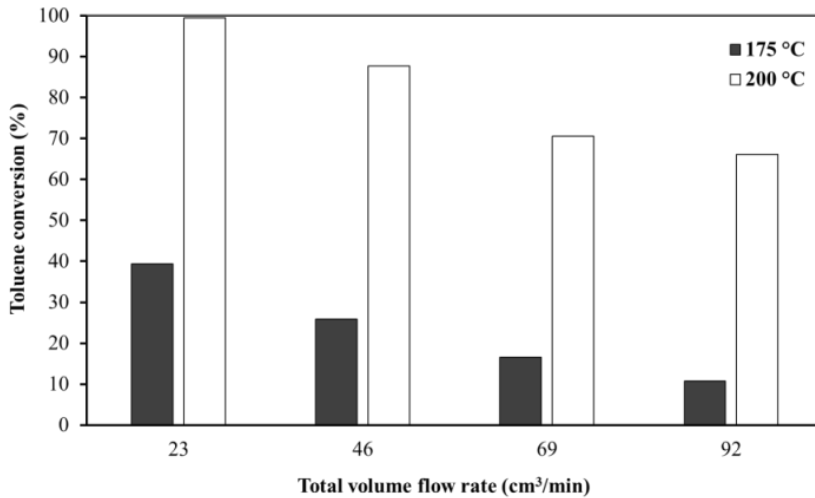

Fig. 8. Toluene conversion as a function of the reaction temperature and space time at constant toluene inlet concentration and catalyst weight ($\gamma(\text{toluene})=210.43$ ppm; m (monolith 2)=0.0025 g)

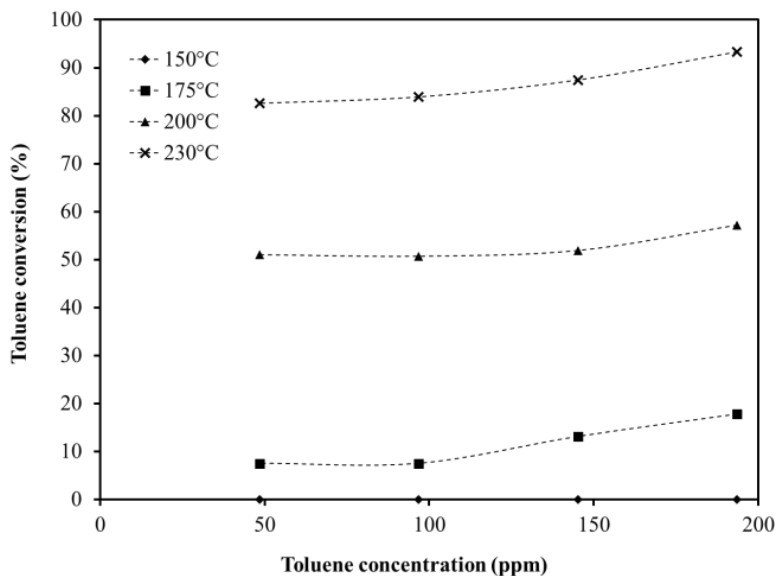

Fig. 9. Conversion of toluene over monolith 2 as a function of toluene inlet concentration at different reaction temperatures and constant total flow rate ($v=100$ cm³/min)

Conclusions

This paper presents an experimental investigation of the catalytic properties of the mixed Mn-Ni based oxide catalysts in toluene combustion. The results of the catalytic tests reveal that the powder catalyst, prepared using the co-precipitation method, presents good activity in the toluene total oxidation, showing complete conversion of toluene at temperature of 350 °C. Similar results have been achieved in the testing of monolithic Mn-Ni catalyst, with much lower amounts of catalytically active phase.

The complete conversion of toluene over a monolithic catalyst in the system with much lower inlet toluene concentration was observed at much lower reaction temperatures, 230-250 °C, depending on the space time inside the reactor. Comparing the results obtained at different inlet toluene concentration, it is clear that the conversion of toluene increases at greater inlet toluene concentration. This is probably because the catalyst possesses a large specific surface area with sufficient number of catalytically active sites. Therefore, the performance of a Mn-Ni based oxide washcoated on metallic monoliths is very promising for catalytic combustion of toluene and other volatile organic compounds. Future research will include further improvement of the activities of the mixed oxides of manganese and other transition metals, with special emphasis on analysis and modelling of the metal monolith reactor using the basic methodology of chemical engineering.

References

- Andersson, A., Larsson, P. O., Swensson, B., Wallenberg, L. R. (1996): Combustion of CO and toluene; characterisation of copper oxide supported on titania and activity comparison with supported cobalt, iron and manganese oxide, *J. Catal.*, 163, 279-293.
- Armaroli, T., Busca, G., Finocchio, E., Gallardo-Amores, J. M., Ramis, G., (1999): A study of anatase-supported Mn oxide as catalysts for 2-propanol oxidation, *Appl. Catal. B: Environ.* 22, 249-259.
- Avila, P., Miro, E., Montes, M. (2005): Monolithic reactors for environmental applications. A review on preparation technologies, *Chem. Eng. J.* 109, 11.
- Banu, I., Bozga, G., Marcu, I., Popescu, I. (2015): A kinetic study of methyl-isobutyl ketone catalytic combustion on LDH-derived containing mixed oxides, *Chem. Eng. Trans.* 43, 997-1002.
- Barbero, B. P., Cadus, L. E., Morales, M. R., (2006): Total oxidation of ethanol and propane over Mn-Cu mixed oxide catalysts, *Appl. Catal. B: Environ.* 67, 229-236.
- Barbero, B. P., Cadus, L. E., Morales, M. R., (2007): Combustion of volatile organic compounds on manganese iron or nickel mixed oxide catalysts, *Appl. Catal. B: Environ.* 74, 1-10.
- Barbero, B. P., Cadus, L. E., Costa-Almeida, L., Montes, M., Morales, M. R., Sanz, O. (2008): Washcoating of metallic monoliths with a MnCu catalyst for catalytic combustion of volatile organic compounds, *Chem. Eng. J.* 139, 430-435.
- Barbero, B. P., Cadus, L. E., Morales, M. R. (2011): MnCu catalyst deposited on metallic monoliths for total oxidation of volatile organic compounds, *Catal. Lett.* 141, 1598-1607.

- Beers, A. E. W., Hoek, I., Kaptejin, F., Moulijn, J. A., Nijhuis, T. A., Vergunst, T. (2001): Preparation of monolithic catalysts, *Catalysis reviews* 43 (4), 346.
- Bernier, A., Delmon, B., Grange, P., Ioannides, T., Lahousse, C., Papaefthimiou, P., Verykios, X. (1998): Evaluation of γ -MnO₂ as a VOC removal catalyst: Comparison with a noble metal catalyst, *J. Catal.*, 178, 214-225.
- Boikov, E. V., Emel'yanov, A. N., Shcherbakov, N. V., Tomskii, I. S., Vishnetskaya, M. V. (2008): The selective oxidation of toluene, *Russ. Journ. Of Phys. Chem. A* 82, 2233-2237.
- Burgos, N., Gandia, L. M., Gil, A., Montes, M., Paulis, M. (2000): New alumina/aluminium monoliths for the catalytic elimination of VOCs, *Stud. in surf. sci. and cat.* 130, 593-598.
- Habibi, M., Hutchings, G. J., Mirzaei, A. A., Shaterian, H. R., Taylor, S. H. (2003): Characterization of copper-manganese oxide catalysts: effect of precipitate ageing upon the structure and morphology of precursors and catalysts, *Appl. Catal. A: General* 253, 499-508.
- Heiszwolf, J. J., Kaptejin, F., Moulijn, J. A., Nijhuis, T. A., (1999): Monoliths in multiphase catalytic processes-aspects and prospects, *Cattech* 3, 24-41.
- Hoek, I., Moulijn, J. A., Nijhuis, T. A., Stankiewicz, A. I. (2004): Performance of the monolithic stirrer reactor: applicability in multi-phase processes, *Chem. Eng. Science* 59, 4975-4981.
- Huang, H., Lu, M., Li, M., Wang, L., Zhang, C., Li, X., Zhang, W. (2016): Catalytic oxidation of toluene over active MnO_x catalyst prepared via an alkali-promoted redox precipitation method, *Reac. Kinet. Mech. Cat.*, 118, 605-619.
- Ihm, S. (2000): Design of environmental catalysis for VOC removal, *Environ. Eng. Res.* 5 (4), 213-222.
- Jiang, W., Li, Y., Wu, D., Zhou, J. (2009): Catalytic combustion of toluene over a copper-manganese-silver mixed-oxide catalyst supported on a washcoated ceramic monolith, *Chem. Eng. Technol.* 32, 1520-1526.
- Jović, F., Tomašić, V. (2006): State-of-the-art in the monolithic catalysts/reactors, *Appl. Catal. A: General* 311, 112.
- Kondarides, D. I., Saqer, S. M., Verykios, X. E. (2011): Catalytic oxidation of toluene over binary mixtures of copper, manganese and cerium oxides supported on γ -Al₂O₃, *Appl. Catal. B: Environ.* 103, 275-286.
- Li, Y., Li, Y., Yu, Q., Yu, L. (2012): The catalytic oxidation of toluene over Pd-based FeCrAl wire mesh monolithic catalysts prepared by electroless plating method, *Catal. Commun.* 29, 127-131.
- Liu, W., Mao, L., Zhang, T. (2004): Gas phase selective oxidation of toluene to benzaldehyde on V₂O₅-Ag₂O/ η -Al₂O₃ catalyst, *Journal of natural gas chemistry* 13, 238-243.

Izvorni znanstveni rad

Utjecaj pčelinjeg voska na toplinska svojstva biorazgradljivih polimera i njihovih mješavina

Katarina Mužina, Mirna Vujnović, Mirela Leskovic*

Sveučilište u Zagrebu, Fakultet kemijskog inženjerstva i tehnologije,
Marulićev trg 19, 10000 Zagreb, Hrvatska

*Dopisni autor: mlesko@fkit.hr

Sažetak

U ovom radu istražena su toplinska svojstva binarnih (PCL/BW, PCL/PLA) i ternarnih (PCL/BW/PLA) mješavina biorazgradljivih polimera poli(ϵ -kaprolaktona) (PCL) i polilaktida (PLA) uz dodatak pčelinjeg voska (BW). Mješavine različitog sastava pripravljene su zamješavanjem u talini. Toplinska svojstva određena su primjenom diferencijalne pretražne kalorimetrije i termogravimetrijske analize. DSC analizom je utvrđeno da BW ima različiti utjecaj na PCL i PLA polimer. BW pokazuje nukleacijski učinak prema PCL dok ometa kristalizaciju PLA. Toplinska postojanost binarnih mješavina PCL/BW raste s porastom količine BW. Dodatak 5%BW u PCL i PLA polimere doprinosi boljoj toplinskoj postojanosti PCL i PLA dok u ternarnim mješavinama rezultira sniženjem toplinske postojanosti.

Ključne riječi: pčelinji vosak, poli(ϵ -kaprolakton), polilaktid, toplinska svojstva

Uvod

Pčelinji vosak (eng. *beeswax*, BW) je organska tvorevina koja se uglavnom sastoji od estera masnih kiselina i alkohola, parafinskih ugljikovodika (alkana) i slobodnih masnih kiselina, uz razne druge spojeve i nečistoće u tragovima (Bogdanov, 2009). Pčelinji vosak ima tipičan miris koji potječe od pčela, meda, propolisa i peludi a njegova žuta boja potječe od propolisa i peludi. Smeđa boja voska ukazuje na prisutnost izlučevina larvi. Pčelinji vosak je inertan materijal visoke plastičnosti pri relativno niskoj temperaturi (oko 32°C) i kristalaste je strukture. Pčelinji vosak pokazuje antimikrobno djelovanje koje uključuje antibakterijsko, antifungicidno i antivirno djelovanje. To svojstvo pčelinjih proizvoda važno je u borbi protiv infekcija uzrokovanih mikrobima. Dva najvažnija antimikrobna proizvoda pčela su med i propolis (Fratini i sur., 2016). Dodatak pčelinjeg voska biorazgradljivim polimerima omogućava dobivanje materijala s antimikrobnim učinkom (Martínez-Abad i sur., 2014). Linearni termoplastični alifatski poliesteri poli(ϵ -kaprolakton) (PCL) i polilaktid (PLA) pokazuju dobra svojstva biorazgradljivosti, biokompatibilnosti i netoksičnosti što ih čini važnim sirovinama za izradu biomedicinskih materijala. Nalaze primjenu u inženjerstvu tkiva i izradi implantata za nadomještaj košanog tkiva (Tan i sur., 2013, Abedalwafa i sur., 2013, Woodruff i sur., 2010). PCL ima dobra svojstva fleksibilnosti i obradivosti te se lako može oblikovati primjenom različitih tehnika (protiskivanjem, prešanjem, izvlačenjem u niti i izlijevanjem).

Kemijsko i biokemijsko inženjerstvo / Chemical and Biochemical Engineering

Zbog visoke kristalnosti PCL njegova je razgradnja sporija u odnosu na PLA polimer. Uz to, zbog hidrofobnosti PCL-a nije lako kontrolirati brzinu njegove razgradnje (Woodruff i sur., 2010). PLA je krhak polimer visoke čvrstoće i brže razgradnje. Zamiješavanje polimera u talini predstavlja relativno jednostavan i jeftini način modifikacije polimernih svojstava u odnosu na kopolimerizaciju. Mješavine posjeduju svojstva koja se razlikuju od svojstava svake pojedine komponente te se odabirom odgovarajućeg sastava polimera mogu dobiti materijali specifičnih svojstava. Zamiješavanjem PCL s PLA polimerom mogu se modelirati svojstva materijala prema željenoj primjeni, definirane morfologije i brzine razgradnje. PCL i PLA polimeri rezultiraju nemješljivom mješavinom (Dell'Erba i sur., 2001). Dodatkom treće komponente moguće je poboljšati kompatibilnost dvaju polimera. Dodatak pčelinjeg voska biorazgradljivim polimerima PCL i PLA omogućava dobivanje materijala novih svojstava uz dodatnu prednost antimikrobnog učinka. U ovom radu istražen je utjecaj pčelinjeg voska (BW) na toplinska svojstva binarnih PCL/BW i ternarnih PCL/BW/PLA mješavina.

Materijali i metode

Materijali korišteni u radu su: poli(ϵ -kaprolakton) (PCL) Capa 6800 - MFR vrijednosti 2,4 g/10 min (160°C, 2,16 kg), tališta 58-60°C, staklišta -60°C, gustoće 1,145 g/cm³, proizvođača Perstorp, UK; polilaktid (PLA) Ingeo 3251D - MFR vrijednosti 35 g/10 min (190°C, 2,16 kg), tališta 155-170°C, staklišta 55-60°C, gustoće 1,24 g/cm³, proizvođača NatureWorks, SAD; pčelinji vosak (BW) – prirodni nerafinirani pčelinji vosak, tališta 61-66 °C, gustoće 0,960 g/cm³, domaće proizvodnje, Hrvatska.

Binarne PCL/PLA mješavine sastava 100/0, 70/30, 50/50, 30/70, 0/100 i ternarne PCL/BW/PLA mješavine sastava 100/5/0, 70/5/30, 50/5/50, 30/5/70, 0/5/100 pripravljene su u Brabender gnjetilici, pri 190°C i brzini okretaja pužnih vijaka 60 okr min⁻¹ u vremenu od 10 minuta. U PCL/PLA mješavine BW je dodan u količini od $w = 5\%$.

Binarne PCL/BW mješavine sastava 100/0, 70/30, 50/50, 0/100 zamiješavane su pri 80°C. Pločice za ispitivanja pripravljene su na hidrauličkoj preši Fontune u kalupu dimenzija 100 × 100 mm, debljine 1 mm pri 200 °C za PCL/PLA i PCL/BW/PLA odnosno pri 80 °C za PCL/BW mješavine.

DSC analiza

DSC analiza ishodnih polimera i mješavina provedena je na uređaju *Mettler Toledo DSC 823e* uz hlađenje hladnjakom. Uzorci mase ~10 mg stavljeni su u aluminijske posudice s poklopcem i hermetički zatvoreni. Ispitivanja su provedena u struji N₂ pri protoku od 50 cm³/min i brzini zagrijavanja/hlađenja od 10°C/min, u dva ciklusa zagrijavanje/hlađenje u temperaturnom području -85 do 200°C. Prvi ciklus zagrijavanja proveden je u temperaturnom intervalu od -85 do 80°C, kako bi se poništila toplinska povijest pripreme uzorka.

Na temelju dobivenih vrijednosti entalpije taljenja izračunata je vrijednost sadržaja kristalne komponente PCL-a, odnosno udio kristalnosti, $\chi_{c(PCL)}$, prema sljedećem izrazu:

$$\chi_{c(PCL)} = \frac{\Delta H_m}{\Delta H_m^0 \cdot w} \cdot 100 \quad (1)$$

gdje je w maseni udio PCL polimera, ΔH_m vrijednost entalpije taljenja kristalne faze, a ΔH_m^0 ekstrapolirana vrijednost entalpije koja odgovara 100 % kristalnom uzorku koja za PCL iznosi 139,3 J/g (Crescenzi i sur., 1972).

Udio kristalnosti PLA proračunat je iz entalpija taljenja i hladne kristalizacije prema sljedećoj jednadžbi:

$$\chi_{c(PLA)} = \frac{(\Delta H_m - \Delta H_{cc})}{\Delta H_m^0 \cdot w} \cdot 100 \quad (2)$$

gdje je w maseni udio PLA polimera, ΔH_m i ΔH_{cc} entalpije taljenja i hladne kristalizacije PLA, a ΔH_m^0 entalpija taljenja 100 % kristalnog PLA koja iznosi 106 J/g (Piorkowska i sur., 2006).

TGA analiza

Toplinska postojanost ishodnih polimera i mješavina određena je primjenom termogravimetrijske analize na uređaju *TA Instruments Q500*. Pripremljeni uzorci mase ~10 mg zagrijavani su u otvorenom platinskom lončiću u inertoj atmosferi dušika (N_2) protoka 60 cm^3/min . Mjerenja su provedena u temperaturnom području od 25 do 600°C, pri brzini zagrijavanja od 10°C/min.

Rezultati i rasprava

DSC analiza predstavlja korisnu tehniku za istraživanje toplinskih svojstava, pruža informacije o fizikalno-kemijskom stanju polimera te također daje korisne informacije o mješljivosti komponenata polimerne mješavine (Dell'Erba i sur. 2001). Na slici 1 prikazane su normalizirane DSC krivulje 2. ciklusa zagrijavanja (a) i hlađenja (b) ishodnih PCL, PLA i BW polimera.

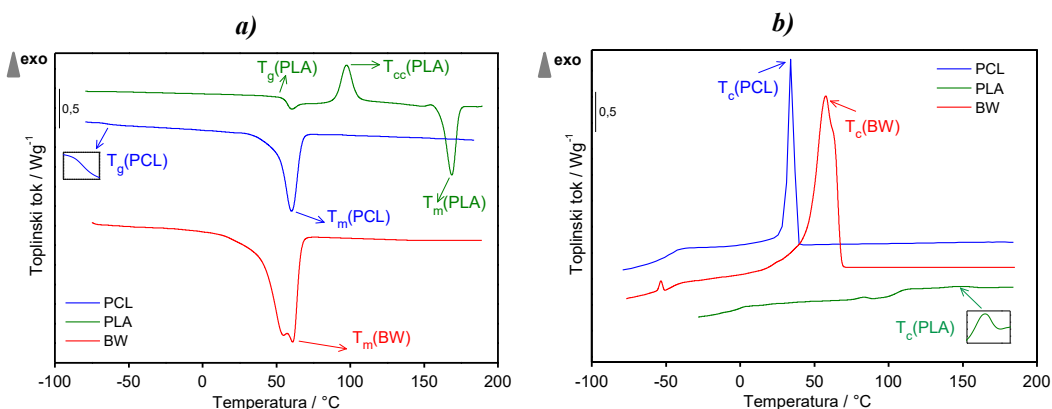

Slika 1. DSC krivulje 2. ciklusa zagrijavanja (a) i hlađenja (b) ishodnih PCL, PLA i BW
Fig. 1. DSC curves of second heating (a) and cooling (b) cycles for neat PCL, PLA and BW

Kemijsko i biokemijsko inženjerstvo / Chemical and Biochemical Engineering

Na DSC krivulji PCL-a u ciklusu zagrijavanja vidljiva su dva prijelaza, staklište pri -65°C (T_g) i endotermni prijelaz taljenja pri 55°C (T_m) (slika 1a i tablica 1) dok se na krivulji hlađenja (slika 1b) javlja jedan egzotermni prijelaz kristalizacije s maksimumom kod 29°C (T_c). Kod PLA vidljiva su tri prijelaza, prvi kod 54°C (T_g) koji odgovara staklištu, drugi egzotermni prijelaz hladne kristalizacije s maksimumom pri 99°C (T_{cc}) nakon kojeg slijedi endotermni prijelaz taljenja kristalita nastalih tijekom hladne kristalizacije pri 168°C (T_m) (slika 1a i tablica 1). Kristalasti polimeri poput PLA kristaliziraju tijekom zagrijavanja (hladna kristalizacija) jer imaju sposobnost spore kristalizacije te nemaju dovoljno vremena da kristaliziraju tijekom hlađenja (Fukushima i sur., 2012). S obzirom da je tijekom hlađenja kristalizacija PLA neznatna na krivulji hlađenja PLA (slika 1b) vidljiv je jedan široki egzotermni prijelaz kristalizacije s maksimumom kod 95°C (T_c). Na DSC termogramu pčelinjeg voska BW u ciklusu zagrijavanja vidljiv je dvostruki široki endoterm taljenja s maksimumom kod 57°C i 62°C (T_m), koji odgovaraju talištu kristalne faze voska različitih uređenosti (Ruguo i sur., 2011). Visoka vrijednost entalpije taljenja od 163 Jg^{-1} $\Delta H_m(\text{BW})$ ukazuje na znatno veći udio kristalne faze u vosku u odnosu na udio kristalne faze prisutne u PCL ($\Delta H_m = 64 \text{ Jg}^{-1}$) i PLA ($\Delta H_m = 46 \text{ Jg}^{-1}$). Na krivulji hlađenja BW-a (slika 1b) vidljiv je jedan egzotermni prijelaz kristalizacije voska s maksimumom kod 51°C (T_c) i entalpije kristalizacije $169 \text{ Jg}^{-1}(\Delta H_c)$.

Binarne mješavine

DSC termogrami 2. ciklusa zagrijavanja i ciklusa hlađenja binarnih mješavina PCL/BW i PCL/PLA prikazani su na slikama 2 i 3. U ciklusu zagrijavanja binarnih PCL/BW mješavina (slika 2a) prijelaz staklišta PCL-a kod -65°C (T_g) ne mijenja se s povećanjem udjela pčelinjeg voska (tablica 1), što ukazuje na nemješljivost PCL i BW. Zhang i sur. na osnovi DSC analize u mješavinama PLLA i PMMA utvrđuju mješljivost na osnovi postojanja jednog staklišta, odnosno djelomičnu mješljivost na osnovi staklišta koja se nalaze između staklišta ishodnih polimera (Zhang i sur., 2003). Endotermni prijelaz taljenja PCL i BW odvija se u istom temperaturnom području. U odnosu na prijelaz taljenja BW-a ovaj prijelaz se kod PCL/BW mješavina javlja u užem temperaturnom području i ima samo jedan oštiji pik taljenja, koji se pomiče na višu temperaturu u odnosu na ishodni PCL, što ukazuje na nastajanje uređenije kristalne strukture. Znatno viša vrijednost entalpije taljenja PCL-a u PCL/BW mješavinama $\Delta H_m(70/30)=66 \text{ Jg}^{-1}$ i $\Delta H_m(50/50)=52 \text{ Jg}^{-1}$ u odnosu na teorijski očekivane s obzirom na sastav ukazuje na veći udio kristalne faze kojoj doprinose i PCL i BW. Nadalje, kod mješavine s 5% BW ne dolazi do pomaka tališta ali se znatno povećava entalpija taljenja PCL-a ($\Delta H_m(100/5)=70 \text{ Jg}^{-1}$) što upućuje na nukleacijski učinak BW-a na PCL matricu.

U ciklusu hlađenja kod PCL/BW mješavina (slika 2b), vidljiva su dva egzotermna prijelaza, koji odgovaraju kristalizaciji ishodnog PCL-a i BW-a.

Dodatkom 50 % BW u PCL/BW mješavini $T_c(\text{PCL})$ se pomiče prema višoj temperaturi a entalpija kristalizacije $\Delta H_c(\text{PCL})$ se povećava u odnosu na ishodni PCL. Istovremeno se entalpija kristalizacije $T_c(\text{BW})$ značajno smanjuje u odnosu na teorijski očekivanu vrijednost. Ovaj rezultat ukazuje na nukleacijsko djelovanje BW u PCL matrici. Četiri prijelaza koja se uočavaju kod binarnih PCL/PLA mješavina (slika 3a) tijekom zagrijavanja, odgovaraju staklištu PCL-a, drugi $\sim 50^{\circ}\text{C}$ koji odgovara taljenju PCL-a preklapa se sa staklastim prijelazom PLA. S obzirom na navedeno nije bilo moguće očitati staklište PLA u mješavinama, već je uz napomenu označenu s (*) vrijednost ovog prijelaza uzeta kao talište PCL-a (tablica 1).

Treći, egzotermni prijelaz koji se javlja u području temperatura 75 – 120 °C odgovara hladnoj kristalizaciji PLA, nakon kojeg slijedi endotermni prijelaz taljenja $\Delta H_m(\text{PLA})$ kod ~ 170 °C (T_m).

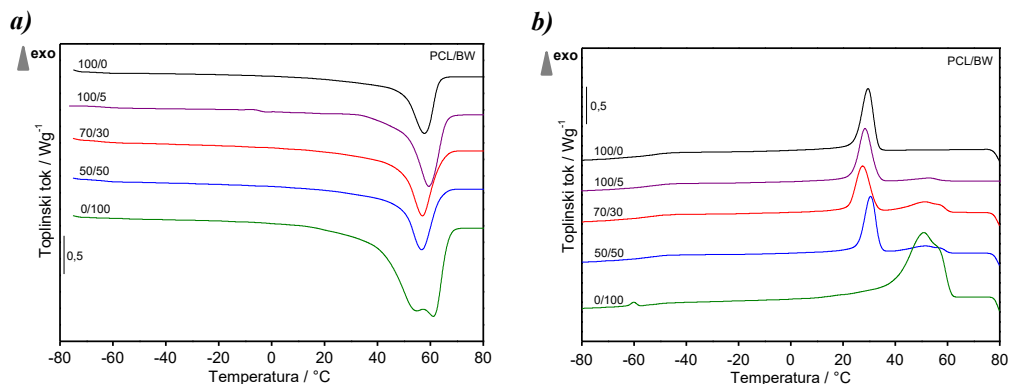

Slika 2. DSC krivulje 2. ciklusa zagrijavanja (a) i ciklusa hlađenja (b) PCL/BW mješavina
Fig. 2. DSC curves of second heating (a) and cooling (b) cycles for PCL/BW blends

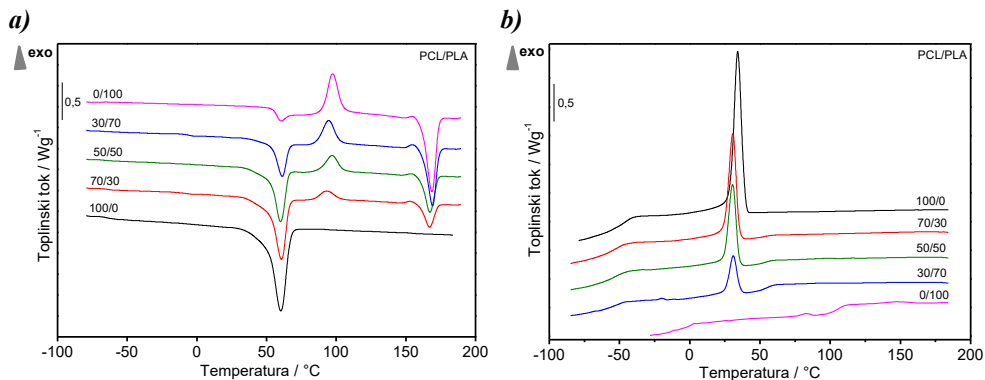

Slika 3. DSC krivulje 2. ciklusa zagrijavanja (a) i ciklusa hlađenja (b) PCL/PLA mješavina
Fig. 3. DSC curves of second heating (a) and cooling (b) cycles for PCL/PLA blends

Iz dobivenih rezultata vidljivo je da se staklište PCL-a u odnosu na ishodni PCL ne mijenja značajno s porastom udjela PLA, uz iznimku izvjesnog sniženja staklišta PCL-a u mješavini sastava 50/50 PCL/PLA. Dobiveni rezultat upućuje na nemješljivost ova dva polimera (Dell'Erba i sur. 2001). Talište $T_m(\text{PCL})$ pomiče se za 1 °C prema višoj temperaturi kod svih PCL/PLA mješavina. U odnosu na ishodne PCL i PLA entalpije taljenja $\Delta H_m(\text{PCL})$ i $\Delta H_m(\text{PLA})$ se smanjuju s porastom udjela PLA u skladu sa sastavom, izuzev mješavine sastava 70/30 kod koje se $\Delta H_m(\text{PLA})$ povećava. Pomak $T_{cc}(\text{PLA})$ prema nižoj temperaturi za mješavinu sastava 30/70 ukazuje na porast brzine kristalizacije i nukleacijski učinak PCL na PLA polimer.

Kemijsko i biokemijsko inženjerstvo / Chemical and Biochemical Engineering

Tijekom hlađenja temperatura kristalizacije $T_c(\text{PCL})$ u PCL/PLA raste za 1-2 °C s porastom količine PLA dok se entalpija kristalizacije mijenja u skladu sa sastavom. Kod PCL/PLA s manjim udjelom PCL-a (sastav 30/70) vidljiv je pomak $T_c(\text{PLA})$ prema nižoj temperaturi za 1 °C, uz značajno sniženje entalpije kristalizacije u odnosu na teorijski očekivanu vrijednost.

Ternarne mješavine

Kod ternarnih PCL/BW/PLA mješavina (slika 4) također su vidljiva četiri prijelaza: (I) koji odgovara staklištu PCL-a, (II) koji odgovara talištu PCL preklapa se s talištem BW voska i staklištem PLA. S obzirom na navedeno nije bilo moguće očitati staklište PLA niti talište BW voska već je uz napomenu označenu s (*) i (/*) vrijednost ovog prijelaza uzeta kao talište PCL polimera (tablica 1). Dodatkom BW u PCL/PLA mješavine ne mijenja se vrijednost temperature taljenja $T_m(\text{PCL})$ i $T_m(\text{PLA})$ dok se vrijednost temperature hladne kristalizacije $T_{cc}(\text{PLA})$ u mješavini sastava 50/5/50 pomiče prema višoj temperaturi u odnosu na PCL/PLA mješavinu istog sastava što ukazuje na sporiju kristalizaciju PLA dodatkom 5% BW (Fukushima i sur. 2012). U mješavini s manjim udjelom PCL, 30/5/70, $T_{cc}(\text{PLA})$ se ne mijenja u odnosu na ishodni PLA. S većim udjelom PCL, 70/5/30 vrijednost $T_{cc}(\text{PLA})$ pomiče se za 3 °C prema nižoj temperaturi što ukazuje na bržu kristalizaciju PLA i nukleacijski učinak PCL na PLA matricu kao i kod PCL/PLA mješavina bez BW.

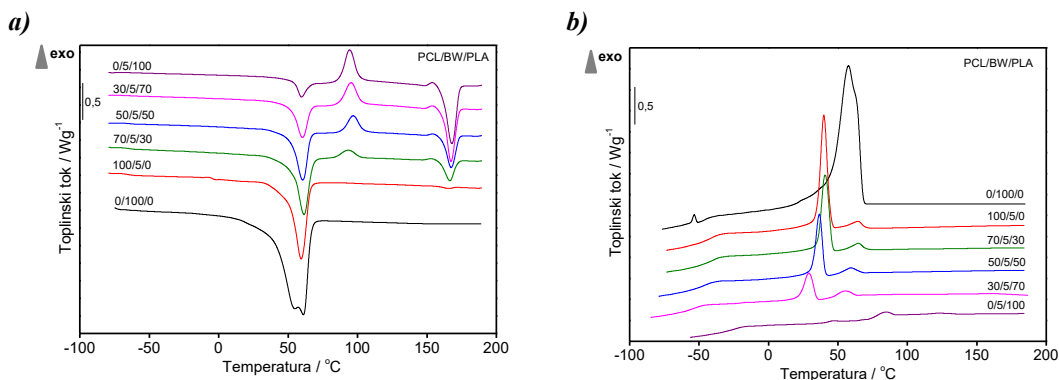

Slika 4. DSC krivulje 2. ciklusa zagrijavanja (a) i ciklusa hlađenja (b) PCL/BW/PLA mješavina
Fig. 4. DSC curves of second heating (a) and cooling (b) cycles for PCL/BW/PLA blends

Više vrijednosti entalpije taljenja $\Delta H_m(\text{PCL})$ u PCL/BW/PLA mješavinama u odnosu na PCL/PLA mješavine (tablica 1) ukazuju na nukleacijski učinak BW na PCL. S druge strane, kontinuirao snižavanje $\Delta H_m(\text{PCL})$ s porastom količine PLA ukazuje da PLA ometa kristalizaciju PCL-a.

Na slici 5 prikazane su vrijednosti stupnja kristalnosti χ_c PCL-a i PLA u ovisnosti o sastavu proračunate prema jednadžbi (1) i (2) dobivene iz DSC termograma PCL, PLA i PCL/PLA mješavina bez i uz dodatak BW-a. Stupanj kristalnosti PCL u PCL/BW mješavinama je znatno viši u odnosu na ishodni PCL, osobito u mješavini s manjim udjelom BW (PCL/BW 70/30) što ukazuje na nukleacijski učinak BW na PCL matricu.

Dodatak PLA značajnije utječe na sniženje stupnja kristalnosti PCL-a u PCL/PLA mješavinama, odnosno PLA ometa kristalizaciju PCL-a. Dodatak 5% BW voska u PCL/BW/PLA mješavine rezultira izvjesnim porastom stupnja kristalnosti PCL-a u odnosu na PCL/PLA mješavine.

Stupanj kristalnosti PLA ($\chi_{c(PLA)}$) u PCL/PLA mješavinama snižava se dodatkom manjeg udjela PCL polimera. Veći udio PCL-a u PCL/PLA mješavini (sastav 70/30) doprinosi porastu stupnja kristalnosti PLA, odnosno potiče kristalizaciju PLA zbog nukleacijskog učinka sekundarne faze. Ta zapažanja su u dobrom slaganju s literaturnim navodima (Sakai i sur., 2009) u kojem je opisana nukleacija PLA u prisutnosti PCL-a. U PCL/BW/PLA mješavinama dodatak BW ne mijenja stupanj kristalnosti PLA pri većem udjelu PCL polimera u odnosu na PCL/PLA mješavinu istog sastava. U mješavini sastava 50/5/50 stupanj kristalnosti PLA dodatno se smanjuje u odnosu na mješavinu bez BW istog sastava. Očito, BW vosak ometa kristalizaciju PLA pri manjem udjelu PCL polimera u mješavini dok na PCL ima nukleacijski učinak te potiče njegovu kristalizaciju. Sniženje stupnja kristalnosti mješavina PCL/BW/PLA 0/5/100 (PLA matrica) i porast stupnja kristalnosti PCL/BW/PLA 100/5/0 (PCL matrica) dodatkom 5% BW u čiste polimere jasno ukazuje na različiti utjecaj BW-a na PLA i PCL polimer.

Tablica 1. DSC podatci binarnih i ternarnih mješavina, 2. ciklus zagrijavanja

Table 1. DSC data of binary and ternary blends, second heating

Mješavina	PCL			PLA					BW	
	T_g / °C	T_m / °C	ΔH_m / J g ⁻¹	T_g / °C	T_{cc} / °C	ΔH_{cc} / J g ⁻¹	T_m / °C	ΔH_m / J g ⁻¹	T_m / °C	ΔH_m / J g ⁻¹
PCL/PLA	100/0	-65	55	64	/	/	/	/	/	/
	70/30	-65	56*	40*	*	95	8	167	15	/
	50/50	-67	56*	26*	*	99	14	168	20	/
	30/70	-65	56*	12*	*	99	19	168	30	/
	0/100	/	/	/	54	99	30	168	46	/
PCL/BW	70/30	-65	57/*	66/*	/	/	/	/	/	/*
	50/50	-64	56/*	52/*	/	/	/	/	/	/*
	0/100	/	/	/	/	/	/	/	/	57-62 163
PCL/BW/PLA	100/5/0	-65	55*	70*	/	/	/	/	/	/*
	70/5/30	-64	55*	42*	*	96	9	167	15	/*
	50/5/50	-65	56*	27*	*	102	16	168	20	/*
	30/5/70	-66	55*	16*	*	99	22	167	30	/*
	0/5/100	/	/	/	#	98	29	167	38	60# 7#

(*) talište PCL se preklapa sa staklištem PLA; (/*) talište PCL i BW u istom su području temperatura;

(#) talište BW se preklapa sa staklištem PLA; T_g - staklište, T_m - talište, ΔH_m - entalpija taljenja, ΔH_{cc} - entalpija hladne kristalizacije

Kemijsko i biokemijsko inženjerstvo / Chemical and Biochemical Engineering

Tablica 2. DSC podatci binarnih i ternarnih mješavina, ciklus hlađenja
Table 2. DSC data for binary and ternary blends, cooling cycle

MJEŠAVINA	PCL		PLA		BW		
	T_c / °C	ΔH_c / J g ⁻¹	T_c / °C	ΔH_c / J g ⁻¹	T_c / °C	ΔH_c / J g ⁻¹	
PCL/PLA	100/0	29	62	/	/	/	/
	70/30	31	41	/	/	/	/
	50/50	30	31	95	0,7	/	/
	30/70	31	15	94	0,5	/	/
	0/100	/	/	95	1,4	/	/
PCL/BW	70/30	28	43	/	/	52	18
	50/50	31	47	/	/	52	10
	0/100	/	/	/	/	51	169
PCL/BW/PLA	100/5/0	29	56	/	/	54	5
	70/5/30	30	40	95	0,1	54	5
	50/5/50	31	26	95	0,1	54	5
	30/5/70	30	16	96	0,5	54	4
	0/5/100	/	/	94	1,2	58	4

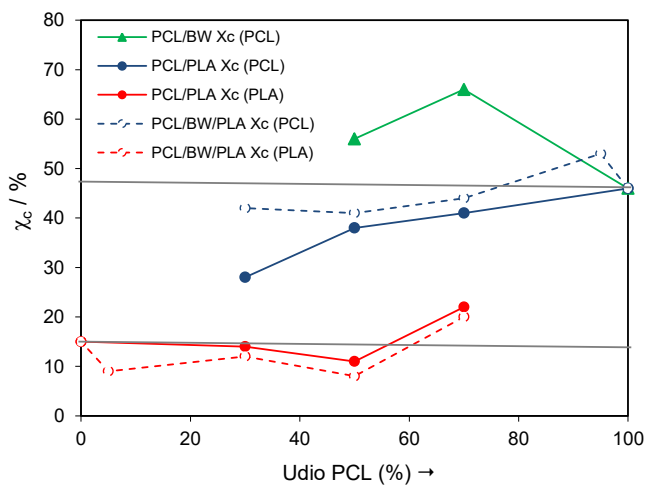

Slika 5. Stupanj kristalnosti PCL i PLA u binarnim i ternarnim mješavinama
Fig. 5. Degree of cristallinity of PCL and PLA in binary and ternary blends

TGA analiza

TG i DTG krivulje binarnih i ternarnih mješavina prikazane su na slikama 5 –7, dok su u tablici 3 dani podatci očitani iz krivulja.

Binarne mješavine

PCL se razgrađuje u jednom stupnju, u relativno uskom području temperatura (oko 70 °C) bez ostatka nakon razgradnje dok se razgradnja BW odvija u dva stupnja u znatno širem temperaturnom području (oko 150 °C), pri čemu preostaje 0,93 % nerazgradivog ostatka (slika 5, tablica 3).

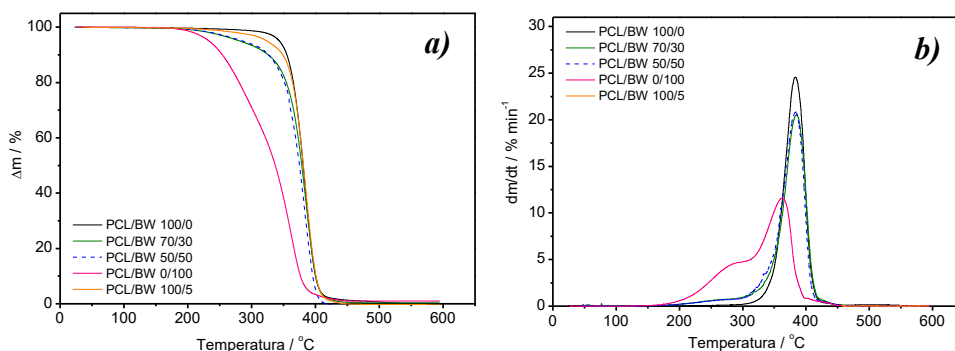

Slika 5. TG (a) i DTG (b) krivulje PCL/BW mješavina
Fig. 5. TG (a) and DTG (b) curves of PCL/BW blends

Toplinska razgradnja PCL-a odvija se cijepanjem poliesterskog lanca reakcijom pirolize kojom se oslobađaju CO_2 , H_2O i nastaju karboksilne kiseline, a kao jedan od produkata je i 5-heksoionska kiselina (Fukushima i sur., 2012). Glavne komponente nakon pirolize pčelinjeg voska su esteri, slobodne kiseline i alkoholi i ugljikovodici (Ren, 2016).

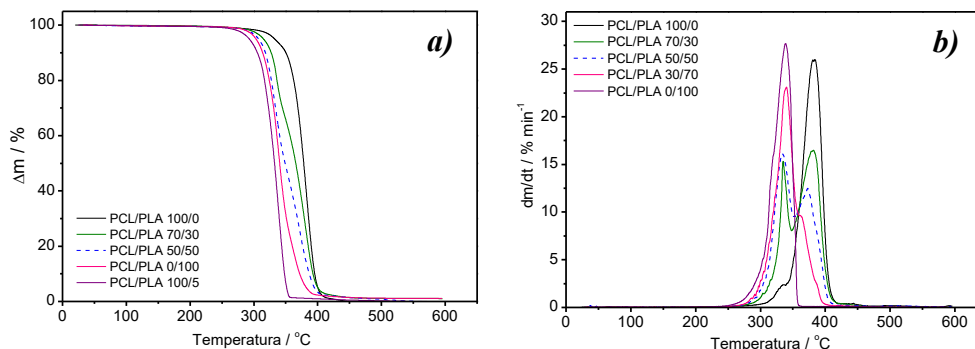

Slika 6. TG (a) i DTG (b) krivulje PCL/PLA mješavina
Fig. 6. TG (a) and DTG (b) curves of PCL/PLA blends

Kemijsko i biokemijsko inženjerstvo / Chemical and Biochemical Engineering

Toplinska razgradnja binarnih PCL/BW mješavina odvija se u jednom razgradnom stupnju u znatno užem temperaturnom području u odnosu na ishodni BW (slika 6). Temperatura pri kojoj uzorak izgubi 5 % početne mase, T_5 , za PCL iznosi 333 °C dok je kod BW niža za 100 °C i iznosi 233 °C. Kod PCL/BW mješavina T_5 se pomiče prema nižoj temperaturi u odnosu na ishodni PCL. Temperatura kod koje uzorak izgubi 50% početne mase, T_{50} pomiče se za 1 do 2 °C prema višoj temperaturi dok se T_{95} (95% gubitka početne mase) za PCL/BW mješavine sastava 70/30 pomiče za 7 °C te za mješavine sastava 50/50 za 10 °C prema višoj temperaturi u odnosu na ishodni PCL. Rezultat ukazuje na porast toplinske postojanosti PCL-a u području viših temperatura. Dodatno ostatak nakon razgradnje raste s porastom udjela BW, što ukazuje na postojanje interakcija između komponenata mješavine i razgradnih produkata. Temperatura pri maksimalnoj brzini razgradnje T_{max} kod mješavine sastava 70/30 ostaje nepromijenjena dok se kod mješavine sastava 50/50 pomiče za 5 °C prema višoj vrijednosti što dodatno ukazuje na povećanje toplinske postojanosti PCL dodatkom veće količine BW i sporiju razgradnju.

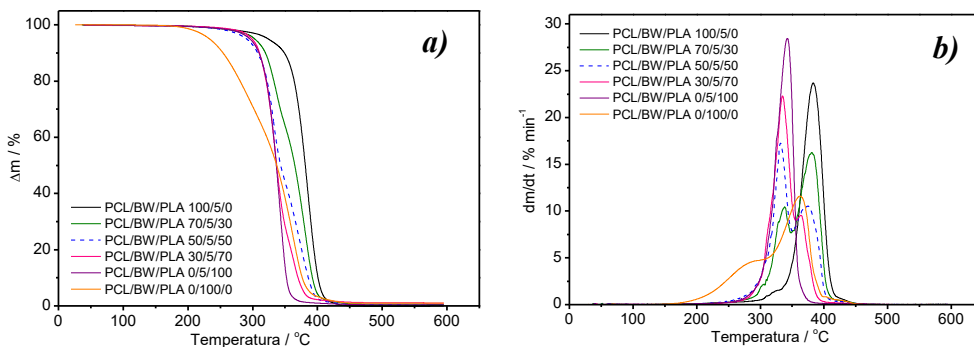

Slika 7. TG (a) i DTG (b) krivulje PCL/BW/PLA mješavina
Fig. 7. TG (a) and DTG (b) curves of PCL/BW/PLA blends

Razgradnja PCL/PLA mješavina odvija se u dva razgradna stupnja, od kojih prvi odgovara razgradnji PLA, a drugi razgradnji PCL-a, slika 7. Povećanjem udjela PLA u PCL/PLA mješavinama temperatura početka razgradnje T_5 , T_{50} i temperature kraja razgradnje T_{95} pomiču se prema nižim vrijednostima (tablica 3) što ukazuje na sniženje toplinske postojanosti. Porast količine ostatka nakon razgradnje ukazuje da dolazi do interakcija polimera s razgradnim produktima.

Ternarne mješavine

Dodatkom 5 % BW u PCL temperatura početka razgradnje, T_5 gotovo se ne mijenja, ali se temperatura T_{50} i T_{95} pomiču prema višoj temperaturi što ukazuje na porast toplinske postojanosti PCL-a. Razgradnja ternarnih mješavina PCL/BW/PLA 70/5/30 odvija se u tri stupnja, od kojih prvi odgovara razgradnji BW, drugi razgradnji PLA, a treći razgradnji PCL-a. Temperature početka razgradnje pojedinih komponenata više su u odnosu na vrijednosti ishodnih komponenti (slika 7, tablica 3).

Razgradnja mješavina PCL/BW/PLA 50/5/50 i 30/5/70 odvija se u dva stupnja. Može se pretpostaviti da prvi stupanj odgovara razgradnji PLA i BW, a drugi razgradnji PCL-a. Dodatak BW u PCL/PLA rezultira sniženjem toplinske postojanosti mješavina. Kod svih ternarnih mješavina prisutan je određeni ostatak nakon razgradnje, a najveći je za mješavinu PCL/BW/PLA 30/5/70. Ostatak nakon razgradnje ukazuje na interakcije polimera s razgradnim produktima.

Tablica 3. Termogravimetrijski podatci binarnih i ternarnih mješavina
Table 3. Thermogravimetric data of binary and ternary blends

MJEŠAVINA	TG				DTG		
	T_5 / °C	T_{50} / °C	T_{95} / °C	Ostatak / %	$T_{max(I)}$ / °C	$T_{max(II)}$ / °C	$T_{max(III)}$ / °C
PCL/PLA	100/0	333	378	400	0,0	-	384
	70/30	315	366	400	0,5	-	335
	50/50	307	349	395	0,0	-	334
	30/70	303	341	382	1,1	-	340
	0/100	293	332	351	0,9	330	339
PCL/BW	70/30	282	379	407	0,3	254	-
	50/50	274	381	410	0,7	343	-
	0/100	233	337	388	0,9	283	363
PCL/BW/PLA	100/5/0	324	381	407	0,0	-	326
	70/5/30	303	365	398	0,5	-	339
	50/5/50	291	343	393	0,3	-	332
	30/5/70	299	337	379	1,0	-	335
	0/5/100	296	337	357	0,3	321	343

T_5 - temperatura kod 5 % gubitka mase, T_{50} temperatura kod 50% gubitka mase,

T_{95} - temperatura kod 95 % gubitka mase T_{max} - temperatura maksimalne brzine razgradnje

Zaključci

Zadatak ovog rada bio je istraživanje utjecaja dodatka BW na toplinska svojstva binarnih i ternarnih PCL/BW, PCL/PLA i PCL/BW/PLA mješavina različitog sastava. DSC analizom je utvrđeno da BW doprinosi porastu stupnja kristalnosti i nastajanju uređenije kristalne strukture PCL-a. Utvrđeno je da su PCL i PLA nemješljivi u čitavom području sastava. Dodatak većeg udjela PCL-a (sastav PCL/PLA 70/30) rezultira uređenijom kristalnom strukturom PLA. Rezultati TGA analize ukazuju da dodatak BW u PCL/BW mješavinama doprinosi porastu toplinske postojanosti PCL u području viših temperatura. Dodatak PLA u PCL/PLA mješavinama snižava toplinsku postojanost PCL-a. U ternarnim mješavinama PCL/BW/PLA, BW dodatak rezultira sniženjem toplinske postojanosti.

Literatura

- Abedalwafa, M., Wang, F., Wang, L., Li, Ch. (2013): Biodegradable Poly-epsilon-caprolactone (PCL) for Tissue Engineering Applications: A review, *Rev.adv. Mater. Sci.* 34, 123-140
- Bogdanov, S. (2009): Beeswax: Production, Properties Composition and Control Beeswax Book, Chapter 2, *Bee Product Science* September 1 1-17.
- Crescenzi, V., Manzini, G., Calzolari, G., Borri, C. (1972): Thermodynamics of fusion of poly- β -propiolactone and poly- ϵ -caprolactone. Comparative analysis of the melting of aliphatic polylactone and polyester chains, *Eur. Polym. J.* 8, 449–463.
- Dell'Erba, R., Groeninckx, G., Maglio, G., Malinconico, M., Migliozi, A. (2001): Immiscible polymer blends of semicrystalline biocompatible components: Thermal properties and phase morphology analysis of PLLA/PCL blends, *Polymer* 42, 7831-7840.
- Fratini, F., Cilia, G., Turchi, B., Felicioli, A. (2016): A. Beeswax: A minireview of its antimicrobial activity and its application in medicine, *Asian Pac. J. Trop.l Med.* 9, 839–843.
- Fukushima, K., Fina, A., Geobaldo, F., Venturello, A., Camino, G. (2012): Properties of poly(lactic acid) nanocomposites based on montmorillonite, sepiolite and zirconium phosphonate, *Express Polym. Lett.* 6, 914–926.
- Martínez-Abad, A., Lagarón J.M., Ocio, M.J. (2014): Antimicrobial beeswax coated polylactide films with silver control release capacity *Int. J. Food microbial.* 17, 39-46.
- Piorkowska, E., Kulinski, Z., Galeski, A., Masirek, R. (2006): Plasticization of semicrystalline poly(L-lactide) with poly(propylene glycol) *Polymer* 47, 7178-7188.
- Ren, L., Cai, Y., Ren, L., Yang, H. (2016): Preparation of Modified Beeswax and Its Influence on the Surface Properties of Compressed Poplar Wood, *Materials* 9 (230), 1 -11.
- Ruguo, Zh., Huab, Zh., Hong, Zh., Ying F., Zhangwenwen, K. L. (2011): Thermal analysis of four insect waxes based on differential scanning calorimetry (DSC), *Procedia Eng.* 18, 101 – 106.
- Sakai, F., Nishikawa, K., Inoue, Y., Yazawa, K. (2009): Nucleation enhancement effect in poly(L-lactide) (PLLA)/poly(ϵ -caprolactone) (PCL) blend induced by locally activated chain mobility resulting from limited miscibility, *Macromolecules* 42, 8335-8342.
- Tan, L., Yu, X., Wan, P., Yang K. (2013): Biodegradable Materials for Bone Repairs: A Review, *J. Mater. Sci. Technol.* 29, 503-513.
- Woodruff, M.A., Hutmacher, D. W. (2010): The return of a forgotten polymer -Polycaprolactone in the 21st century, *Prog. in Polym. Sci.*, 35 1217-1256.
- Zhang, G., Zhang, J., Wang, S., Shen, D. (2003): Miscibility and Phase Structure of Binary Blends of Polylactide and Poly(methyl methacrylate), *J.Polym. Sci. B: Polym. Phys.* 41, 23–30.

Original research paper

Influence of beeswax on the thermal properties of biodegradable polymers and their blends

*Katarina Mužina, Mirna Vujnović, Mirela Leskovic**

*University of Zagreb, Faculty of Chemical Engineering and Technology,
Marulićev trg 19, 10000 Zagreb, Croatia*

**Corresponding author: mlesko@fkit.hr*

Summary

Thermal properties of the binary (PCL/BW, PCL/PLA) and ternary (PCL/BW/PLA) blends of biodegradable poly(ϵ -caprolactone) (PCL) and polylactide (PLA) polymers of various compositions with the addition of beeswax (BW) prepared by melt mixing, were investigated. Thermal properties were determined by using differential scanning calorimetry and thermogravimetric analysis. DSC analysis showed that BW has a different effect on PCL and PLA polymer properties. BW shows nucleating effect against PCL while it hinders crystallization of PLA. Thermal stability of PCL/BW binary blends increases with the amount of BW. The addition of 5% of BW to PCL and PLA polymers contributes to better thermal stability of PCL and PLA polymers while it resulted in lower thermal stability in ternary blends.

Keywords: beeswax, poly(ϵ -caprolactone), polylactide, thermal properties

Sekcija: Prehrambena tehnologija i biotehnologija
Session: Food Technology and Biotechnology

Original research paper

Dihydrochalcones in old apple varieties from Croatia

Lidija Jakobek^{1*}, Petra Krivak¹, Martina Medvidović Kosanović², Anamarija Šter²

¹*Josip Juraj Strossmayer University of Osijek, Faculty of Food Technology Osijek,
Franje Kuhača 20, HR 31000 Osijek, Croatia*

²*Josip Juraj Strossmayer University of Osijek, Department of Chemistry,
Cara Hadrijana 8/A, HR 31000 Osijek, Croatia*

**Corresponding author: lidija.jakobek@ptfos.hr*

Summary

Dihydrochalcones are the only subgroup of polyphenols that is specific to apples. They showed many beneficial bioactivities. In this work, the aim was to analyze dihydrochalcones in old apple varieties from Croatia to see if varieties differ amongst themselves according to dihydrochalcone percentage. Dihydrochalcones were extracted from the peel and flesh of five old apple varieties (Lještarica, Ljetna rebrača, Slavonska srčika, Zimnjara, Adamova zvijezda) and from wild apples (crabapples). Reverse-phase high performance liquid chromatography was used to identify dihydrochalcones (phloretin-2'-xyloglucoside and phloretin-2'-glucoside in the flesh; phloretin-2'-glucoside in the peel) and to express their percentage in relation to all other polyphenol subclasses. Dihydrochalcones occupied from 3 to 12.4 % in the flesh and from 0.8 to 10.8 % in the peel. Slavonska srčika and Adamova zvijezda showed higher dihydrochalcone percent in the flesh and peel. Principal component analysis also confirmed that Slavonska srčika and Adamova zvijezda differed from other varieties by higher dihydrochalcone percent. The pattern in the dihydrochalcone distribution was not shown. Although dihydrochalcones do not occupy a high portion in the polyphenol content, they are still an important feature of old varieties.

Keywords: phloretin, phloridzin, dihydrochalcones, old varieties, apple

Introduction

Dihydrochalcones are a subgroup of polyphenolic compounds. Structurally they differ from some usual polyphenols (flavonoids) because an open structure and a differently numbered carbon skeleton (Tomás-Barberán and Clifford, 2000). They can be found in apples in which they actually represent a specific feature. The main dihydrochalcones found in apple's flesh are phloretin-2'-xyloglucoside and phloretin-2'-glucoside while the peel is characterized by the phloretin-2'-glucoside (Tsao et al., 2003).

The interest in dihydrochalcones increased in recent couple of decades since they are known to have some beneficial bioactivities (Ehrenkranz et al., 2005). Mostly, their beneficial effects were connected to the effects on diabetes and glucose level lowering. It was shown that dihydrochalcones can reduce blood glucose levels in mice (Masumoto et al., 2009; Kobori et al., 2012) which can be

helpful in the prevention of hyperglycemia. A potential anti-diabetic drug on the basis of phloretin-2'-glucoside has been developed (Ikumi et al., 2008; Sakuma et al., 2009). Due to these beneficial activities, dihydrochalcones are a subject of many studies.

Old apple varieties have been grown in the past and now days they are actually neglected. According to our earlier studies, they can be a good source of dihydrochalcones (Jakobek et al., 2013, Jakobek and Barron, 2016). Namely, it was shown that some old varieties have the potential to have higher dihydrochalcone content in the flesh (Jakobek et al., 2013, Jakobek and Barron, 2016) in comparison to commercial varieties (Khanizadeh et al., 2008; Lamperi et al., 2008). Therefore, the dihydrochalcone content might be an important characteristic of these old varieties. By analyzing dihydrochalcones which showed many potential bioactivities, the important characteristic of apples is being analyzed, which can impact the recognition of these old varieties as an important source of polyphenols. Furthermore, apple varieties differ by the portion of certain polyphenolic subgroups, like phenolic acids or flavan-3-ols (Jakobek and Barron, 2016). Namely, varieties with a higher phenolic acid portion usually have a lower flavan-3-ol portion and vice versa. Mentioned differences are usually dependent on genetic variability. Since, dihydrochalcones are specific to apples, it would be interesting to know if the dihydrochalcone portion also follows a certain pattern. That would be another reason to recognize some old apple varieties as an important source of dihydrochalcones.

The aim of this study was to identify dihydrochalcones in six old apple varieties by using reversed-phase high performance liquid chromatography with photodiode array detection (RP-HPLC-PDA) and to express their percentage in relation to all other polyphenol subclasses. Furthermore, the aim was to see if there are some differences between varieties based on the dihydrochalcone percentage. That is why the data were analyzed with one-way ANOVA and post-hoc Tukey test. Principal component analysis was used to see possible clustering of varieties. Additionally, the dihydrochalcone percentage was compared to the percentage of other polyphenols to see if a pattern in a dihydrochalcone distribution could be seen.

Materials and Methods

Chemicals

Dihydrochalcone standard was purchased from Extrasynthese (Genay, France) (phloretin-2'-*O*-glucoside (phloridzin - 1046 \geq 95 %)). Other chemicals were purchased from Fluka (Buchs, Switzerland) (*ortho*-phosphoric acid (85 %, HPLC grade)), J. T. Baker (Deventer, Netherlands) (HPLC grade methanol) and Kemika (Zagreb, Croatia) (hydrochloric acid (36.2 %)).

Samples and sample preparation

Old apple varieties (*Malus domestica*) (Lještarika, Ljetna rebrača, Slavonska srčika, Zimnjara, Adamova zvijezda, and a wild variety (crabapple)) were harvested in October/November 2015 in a family orchard (Mr. Veić, Mihaljevci, near Požega, Croatia). One kilogram of apples was peeled, the peel was pooled and homogenized for 15 seconds in small portions using a coffee blender. The flesh was then cut into smaller pieces, after removing the core and the seeds. Flesh was pooled and homogenized for 1 minute with a stick blender. Samples were immediately placed in a freezer at -18 °C.

Prehrambena tehnologija i biotehnologija / Food Technology and Biotechnology

Polyphenol extraction

0.1 % HCl in methanol was used to extract polyphenols from the peel, and 80 % methanol to extract polyphenols from the flesh (Jakobek et al., 2015). Shortly, samples of flesh and peel were weighed (0.2 g) in cuvettes, mixed with 1.5 ml of extraction solvent and vortexed (Grant Bio, Cambridgeshire, England). Cuvettes were placed in the ultrasonic bath (Bandelin Sonorex, RK 100, Berlin, Germany) for 15 minutes and then centrifuged (Minispin, Eppendorf AG, Germany). After removing extracts, residues were extracted one more time with 0.5 ml of extraction solvent. Extracts were combined and filtered through a 0.45 μm polytetrafluoroethylene (PTFE) syringe filter. Two parallel extracts were prepared for each peel or flesh sample.

Reversed phase high-performance liquid chromatography with photodiode array detection (RP-HPLC-PDA)

Varian HPLC system (Varian Inc., Palo Alto, USA) which consists of ProStar 230 solvent delivery module, ProStar 330 PDA detector, OmniSpher C18 column (250 x 4.6 mm, 5 μm) and guard column (ChromSep 1 cm x 3 mm) was used to analyze polyphenols according to our earlier developed method (Jakobek et al., 2015). Mobile phases were 0.1% phosphoric acid in water (A) and 100 % methanol (B). The gradient was: 5% B (0 min), 25 % B (5 min), 34 % B (14 min), 37% B (25 min), 40% B (30 min), 49% B (34 min), 50% B (35 min), 51% B (58 min), 55% B (60 min), 80% B (62 min), 80% B (65 min), 5% B (67 min) and 5% B (72 min). Other conditions were: the flow rate 0.8 ml min⁻¹, injection volume 20 μl , spectra recording from 190-600 nm. Standard phloretin-2'-glucoside (200 mg L⁻¹) was prepared in ethanol and analyzed with the same method. Chromatograms were scanned at 280, 320, 360 and 510 nm. Dihydrochalcones were detected at 280 nm. Phloretin-2'-glucoside in the flesh and peel was identified by comparison of retention times and spectral data with the once from standard. Phloretin-2'-xyloglucoside was tentatively identified in the flesh with the help of literature data (Tsao et al., 2003). Other polyphenolic subgroups were recognized by their characteristic spectra features (UV/Vis maximum of flavan-3-ols, phenolic acids, flavonols, anthocyanins at 271; 301 or 314; 350; and 510 nm, respectively). Peak areas of dihydrochalcones at 280 nm (phloretin-2'-glucoside and phloretin-2'-xyloglucoside), flavan-3-ols at 280 nm, phenolic acids at 310 nm, flavonols at 360 nm and anthocyanins at 510 nm were expressed as percentages in the total peak area.

Statistical analysis

Two extracts from each flesh and peel were prepared. Extracts were analyzed once with the RP-HPLC-PDA method. Dihydrochalcone percentage and percentages of other polyphenolic subclasses was based on n = 2. The data were analyzed with post-hoc Tukey pairwise comparison tests which are auxiliary to one-way ANOVA. Furthermore, dihydrochalcone percentages in flesh and peel were analyzed with principal component analysis in order to visualize possible clustering of varieties. All the statistical analyzes were carried out using the analytical software Statistica (Statsoft, Tulsa).

Results and Discussion

The description of old apple varieties is shown in Table 1. Three varieties had red or light red peel while the peel in others was yellowish. Five of these varieties were already analyzed before

(Jakobek et al., 2013; Jakobek and Barron, 2016) but Ljetna rebrača was analyzed for the first time, to the best of our knowledge. It should be mentioned that some of these apples could be present in other surrounding countries with similar or different names, but for this work apples originated from Croatia. Moreover, one variety Slavonska srčika is considered as indigenous for Croatia which gives this variety a special importance.

Table 1. Description of old apple varieties

Apple variety	Harvest maturity	Flesh color	Fruit skin color
Lještarka	Late	Yellowish	Red
Ljetna rebrača	Late	Yellowish	Red
Slavonska srčika	Late	Yellowish	Light red
Zimnjara	Late	Yellowish	Yellow green
Adamova zvijezda	Late	Yellowish	Yellowish
Wild apple	Late	Yellowish	Yellowish

Fig. 1 shows chromatograms of flesh and peel scanned at 280 nm. Dihydrochalcones (Fig. 2) were identified as phloretin-2'-xyloglucoside and phloretin-2'-glucoside in the flesh and phloretin-2'-glucoside in the peel. They showed a characteristic UV/Vis absorption at 276 nm. This agrees with the literature data (Tsao et al., 2003).

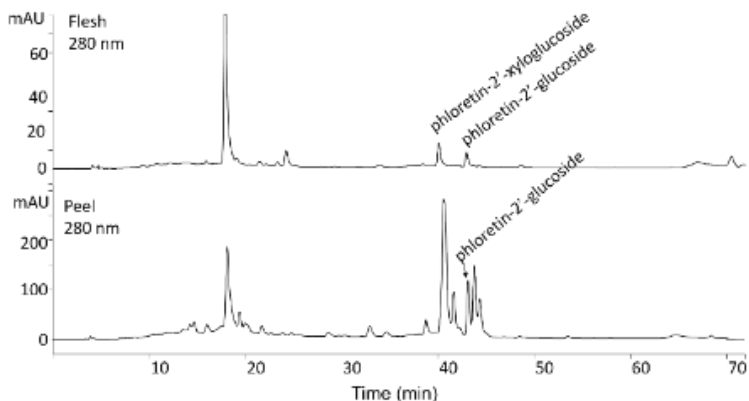

Fig 1. Chromatogram of apple flesh and peel scanned at 280 nm with dihydrochalcones identified in apples (Slavonska srčika variety)

The percentage of dihydrochalcones (Fig. 2) was calculated as a percentage of their peak areas in relation to percentage of peak areas of all other polyphenols at 280, 320, 360 and 510 nm. The results are shown in Fig. 3. In the flesh, the dihydrochalcone percentage varied from 3.7 to 12.4 %. Varieties that had high dihydrochalcone percentage in the flesh were Adamova zvijezda, Zimnjara, Slavonska srčika and Lještarka. Those varieties were also statistically similar. Varieties Ljetna rebrača and wild apples had lower portion of dihydrochalcones.

Prehrambena tehnologija i biotehnologija / Food Technology and Biotechnology

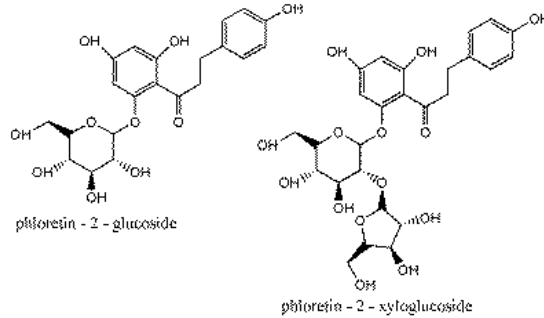

Fig. 2. Dihydrochalcones from apples: phloretin-2'-glucoside and phloretin-2'-xyloglucoside

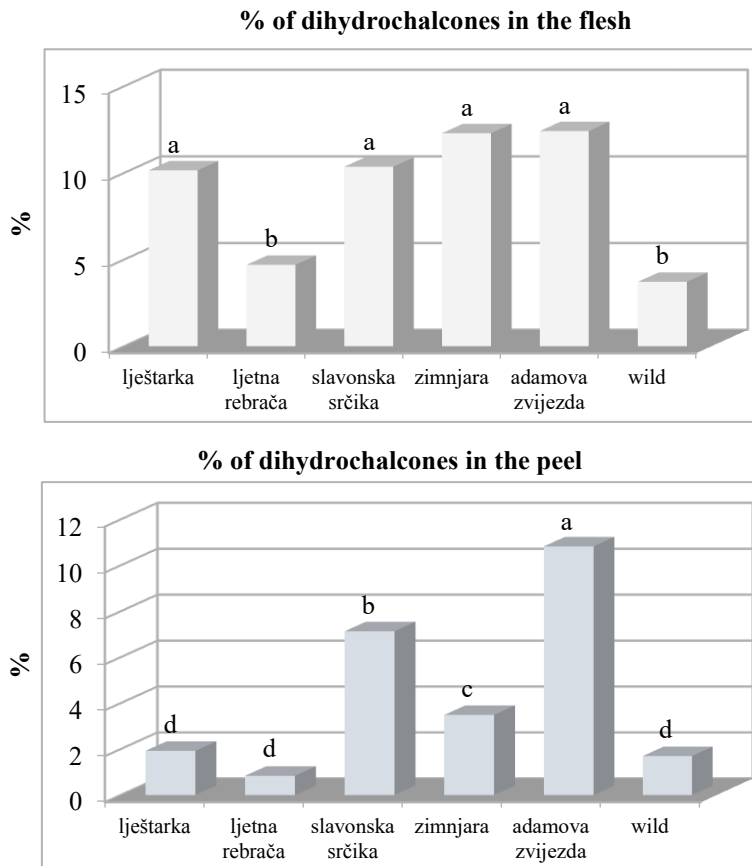

Fig. 3. Dihydrochalcone percentage in the flesh and peel of old apple varieties

In the peel (Fig. 3.), the dihydrochalcone percentage was between 0.8 to 10.8 %. Varieties with the highest dihydrochalcone percentage were Adamova zvijezda and Slavonska srčika. Zimnjara, Lještarka, wild apple and Ljetna rebrača were characterized with the lower dihydrochalcone percentage. In general, two varieties can be highlighted with somewhat higher dihydrochalcone percentage in both, flesh and peel: Adamova zvijezda and Slavonska srčika. The differences are statistically significant.

To see if varieties cluster according to the dihydrochalcone percentage, principal component analysis was conducted. This is a statistical tool that enables better visualization of data and possible clustering (Fig. 4.). All six varieties showed good separation, which points to their differences according to the dihydrochalcone percentage. Adamova zvijezda and Slavonska srčika positioned in the upper right corner of the diagram which could mean they are similar according to dihydrochalcones and it could be suggested that they create a separate cluster. Wild apple and Ljetna rebrača separated into the upper left corner, and Lještarka and Zimnjara positioned in the lower part of the diagram. In general, it is visible that varieties differ by the dihydrochalcone percentage and possible grouping into three clusters could be seen.

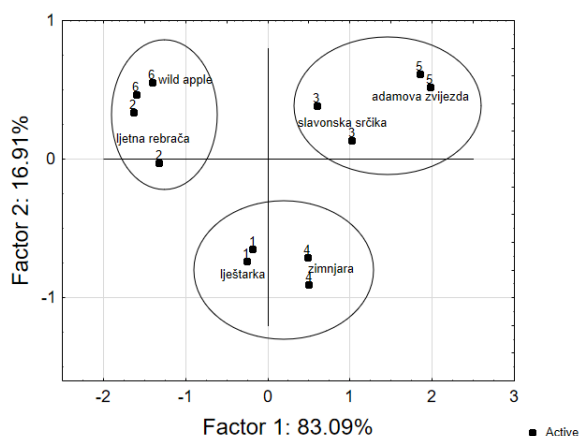

Fig. 4. Principal component analysis (PCA) of dihydrochalcone percentage in the flesh and peel of old apple varieties

Fig. 5 shows percentage distribution of all polyphenol subclasses. In the flesh, a certain pattern in the polyphenol distribution could be seen. Namely, varieties with the higher phenolic acid percentage had lower flavan-3-ol percentage and vice versa. This agrees with earlier studies (Ceymann et al., 2012; Jakobek and Barron, 2016). But there was no visible pattern connected to the dihydrochalcone distribution. In the peel, a pattern in the polyphenol distribution could not be seen. In earlier study (Voltz and McGhie, 2011) most of the variability in polyphenols was ascribed to genetic variability and exceptions were flavonols which were mostly affected by environment. The genetic variability could be the reason for the polyphenol variability in our study. Dihydrochalcones are studied more in the last few decades due to their potential beneficial effect like the effect on the

Prehrambena tehnologija i biotehnologija / Food Technology and Biotechnology

type 2 diabetes, weight loss and hyperglycemia (Ehrenkranz et al., 2005). Their possibility to reduce blood glucose levels was shown in animal studies on mice (Kobori et al., 2012; Masumoto et al., 2009). Furthermore, phloridzin conjugates showed the potential as an oral anti-diabetic drug (Ikumi et al., 2008; Sakuma et al., 2009). It was suggested that some products with high phloridzin content like pomace of unripe apples could be used for the reduction of postprandial glycemia (Makarova et al., 2015). The binding of phloridzin to human serum albumin, the most abundant protein in the human plasma which is considered a transporter of many drugs and chemical contaminants, was studied too (Yue et al., 2011). Phloridzin binds to the human serum albumin via hydrophobic force and hydrogen bonds (Yue et al., 2011). Since dihydrochalcones have shown many potential bioactivities, and they are studied as a possible drug, their content in natural food sources could be important.

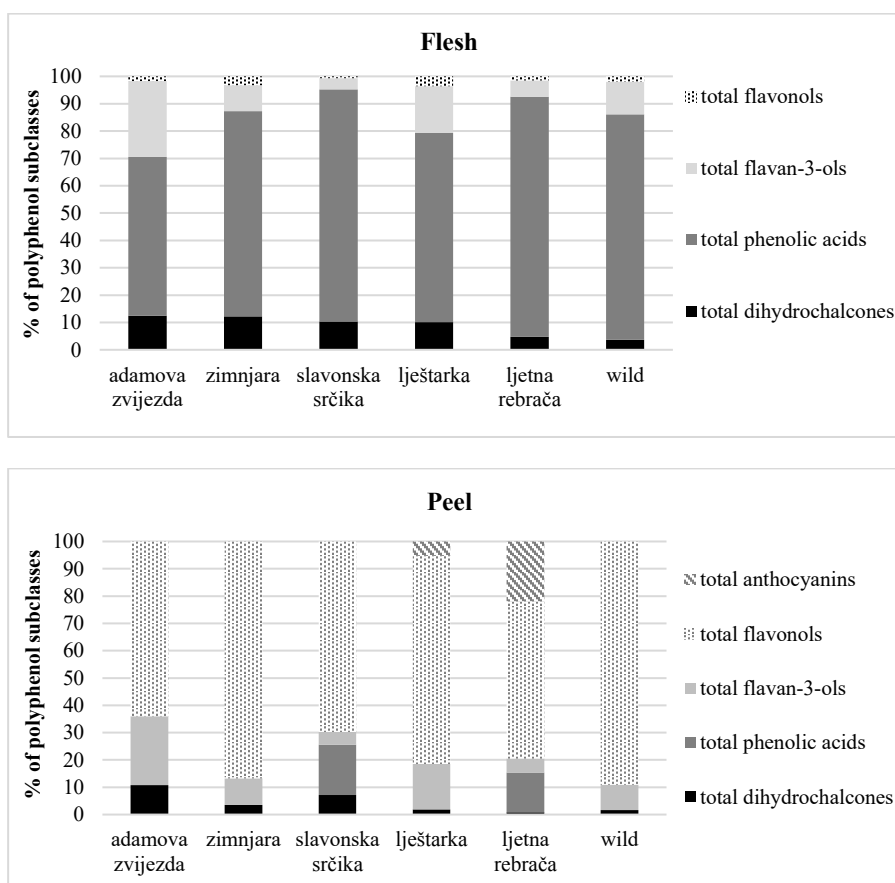

Fig. 5. Percentages of all polyphenol subclasses in flesh and peel of old apple varieties

Dihydrochalcones are specific to apples and their products. Their content can vary depending on the variety (Jakobek and Barron, 2016.; Khanizadeh et al., 2008; Veberic et al., 2005; Wojdyło et al., 2008) and they can be found in flesh and peel. Moreover, the content can be some 4 to 9 times higher in the peel than in the flesh (Khanizadeh et al., 2008; Tsao et al., 2003). When eating apple, many people discard the peel which means that some dihydrochalcones are actually discarded. In this case, the apple flesh as a source of dihydrochalcones can be very important. Some varieties that have higher content or portion of dihydrochalcones in the flesh can be important. In this work, varieties with the higher dihydrochalcone portion in the flesh were Adamova zvijezda, Zimnjara, Slavonska srčika. But in general, if the dihydrochalcone percentage in the flesh and peel together is taken into account, Slavonska srčika and Adamova zvijezda might be important. The dihydrochalcone portion in these old varieties might be considered as their specific feature.

Conclusions

In this work, dihydrochalcones from old apple varieties were analyzed. The usual dihydrochalcones were identified, phloretin-2'-xyloglucoside and phloretin-2'-glucoside in the flesh and phloretin-2'-glucoside in the peel. The dihydrochalcone percentage varied in the flesh from 3.7 to 12.4 %. In the peel, the dihydrochalcone percentage was between 0.8 to 10.8 %. Two varieties could be highlighted with somewhat higher dihydrochalcone percentage in both, flesh and peel: Adamova zvijezda and Slavonska srčika. Principal component analysis showed that apple varieties differ by the dihydrochalcone percentage. The pattern in the dihydrochalcone distribution was not shown.

Acknowledgment: We would like to thank to Mr. Mirko Veić for the donation of apple samples.

Funding: The work was financed by Adris foundation from Croatia.

References

- Ceymann, M., Arrigoni, E., Schärer, H., Bozzi Nising, A., Hurrell, R.F. (2012): Identification of apples rich in health-promoting flavan-3-ols and phenolic acids by measuring the polyphenol profile, *J. Food Compos. Anal.* 26, 128-135.
- Ehrenkranz, J.R.L., Lewis, N.G., Kahn, C.R., Roth, J. (2005): Phloridzin: a review, *Diabetes-Metab. Res. Rev.* 21, 31-38.
- Ikumi, Y., Kida, T., Sakuma, S., Yamashita, S., Akashi, M. (2008): Polymer-phloridzin conjugates as an anti-diabetic drug that inhibits glucose absorption through the Na⁺/glucose cotransporter (SGLT1) in the small intestine, *J. Control. Release.* 125, 42-49.
- Jakobek, L., García-Villalba, R., Tomás-Barberán, F.A. (2013): Polyphenolic characterisation of old apple varieties from Southeastern European region, *J. Food Compos. Anal.* 31, 199-211.
- Jakobek, L., Boc, M., Barron, A.R. (2015): Optimization of ultrasonic-assisted extraction of phenolic compounds from apples, *Food Anal. Meth.* 8, 2612-2625.
- Jakobek, L., Barron, A.R. (2016): Ancient apple varieties from Croatia as a source of bioactive polyphenolic compounds, *J. Food Compos. Anal.* 45, 9-15.

Prehrambena tehnologija i biotehnologija / Food Technology and Biotechnology

- Khanizadeh, S., Tsao, R., Rekika, D., Yang, R., Charles, M.T., Rupasinghe, H.P.V. (2008): Polyphenol composition and total antioxidant capacity of selected apple genotypes for processing, *J. Food Compos. Anal.* 21, 396-401.
- Kobori, M., Masumoto, S., Akimoto, Y., Oike, H. (2012): Phloridzin reduces blood glucose levels and alters hepatic gene expression in normal BALB/c mice, *Food Chem. Toxicol.* 50, 2547-2553.
- Lamperi, L., Chiuminatto, U., Cincinelli, A., Galvan, P., Giordani, E., Lepri, L., Del Bubba, M. (2008): Polyphenol levels and free radical scavenging activities of four apple cultivars from integrated and organic farming in different Italian areas, *J. Agric. Food Chem.* 56, 6536-6546.
- Makarova, E., Górnas, P., Konrade, I., Tirzite, D., Cirule, H., Gulbe, A., Pugajeva, I., Seglina, D., Dambrova, M. (2015): Acute anti-hyperglycemic effects of an unripe apple preparation containing phlorizin in healthy volunteers: a preliminary study, *J. Sci. Food Agric.* 95, 560-568.
- Masumoto, S., Akimoto, Y., Oike, H., Bobori, M. (2009): Dietary phloridzin reduces blood glucose levels and reverses Sglt1 expression in the small intestine in Streptozotocin-induced diabetic mice, *J. Agric. Food Chem.* 57, 4651-4656.
- Sakuma, S., Sagawa, T., Masaoka, Y., Kataoka, M., Yamashita, S., Shirasaka, Y., Tamai, I., Ikumi, Y., Kida, T., Akashi, M. (2009): Stabilization of enzyme-susceptible glucoside bonds of phloridzin through conjugation with poly(γ -glutamic acid), *J. Control. Release.* 133, 125-131.
- Tomás-Barberán, F.A., Clifford, M.N. (2000): Flavanones, chalcones and dihydrochalcones – nature, occurrence and dietary burden, *J. Sci. Food Agric.* 80, 1073-1080.
- Tsao, R., Yang, R., Young, J.C., Zhu, H. (2003): Polyphenolic profiles in eight apple cultivars using high-performance liquid chromatography (HPLC), *J. Agric. Food Chem.* 51, 6347-6353.
- Veberic, R., Trobec, M., Herbinger, K., Hofer, M., Grill, D., Stampar, F. (2005): Phenolic compounds in some apple (*Malus domestica* Borkh) cultivars of organic and integrated production, *J. Sci. Food Agric.* 85, 1687-1694.
- Volz, R.K., McGhie, T.K. (2011): Genetic variability in apple fruit polyphenol composition in *Malus x domestica* and *Malus sieversii* germplasm grown in New Zealand, *J. Agric. Food Chem.* 59, 11509-11521.
- Wojdyło, A., Oszmiański, J., Laskowski, P. (2008): Polyphenolic compounds and antioxidant activity of new and old apple varieties, *J. Agric. Food Chem.* 56, 6520-6530.
- Yue, Y., Liu, J., Fan, J., Yao, X. (2011): Binding studies of phloridzin with human serum albumin and its effect on the conformation of protein, *J. Pharm. Biomed. Anal.* 56, 336-342.

Original research paper

Effect of extraction conditions on extraction yield, total polyphenolic content and antioxidant capacity of yarrow (*Achillea millefolium* L.)

Maja Benković*, Ana Belščak-Cvitanović, Tamara Jurina, Davor Valinger, Ana Jurinjak Tušek, Marija Jakelić, Jasenka Gajdoš Kljusurić

University of Zagreb, Faculty of Food Technology and Biotechnology, Pierottijeva 6, 10000 Zagreb, Croatia

*Corresponding author: mbenkovic@pbf.hr

Summary

In search for novel, functional foods, the food industry is turning towards utilization of herbal extracts in food products. The use of medicinal plants, a widespread source of bioactive compounds, with well documented functional properties is becoming more appealing for the food industry. Yarrow (*Achillea millefolium* L.) is rich in flavonoids, tannins, sterols and salicylic acid. In order to obtain the highest possible amount of bioactives, efficient extraction procedures are required. The aim of this paper is to optimize and define the effect of extraction conditions on extraction yield, total polyphenolic content and antioxidant capacity of yarrow. Particle size, duration of the extraction process, mixing speed and temperature were taken into account as factors influencing the water extraction of bioactive compounds from yarrow. The following extraction conditions resulted in the highest extraction yield (0.82 % of dry mater): particle size less than 100 μm , 30 minutes extraction at 80 °C and 500 min^{-1} rotation speed. These conditions are also optimal for extraction of the antioxidant compounds and total polyphenols. Based on the results of this study, temperature, duration, particle size and mixing speed have a simultaneous influence on the extraction yield, total polyphenolic content and antioxidant capacity of yarrow extracts.

Keywords: extraction, optimization, particle size, temperature, yarrow

Introduction

In search of new functional food products, food industry is turning towards wide spread sources of bioactive compounds present in nature. Medicinal plants have been grown since ancient times and used in folk medicine to treat different autoimmune, cardiovascular and gastrointestinal disorders. The source of their bioactive properties is the presence of vast amounts of biologically active compounds such as vitamins, polyphenols, alkaloids, glycosides and terpenes. Numerous compounds from medicinal plants have also been recognized as herbal remedies: opium, aspirin, digitalis and quinin.

Yarrow (*Achillea millefolium* L.) is known as a medicinal plant widespread in moderate climate regions of Europe, North America and Asia. Different species from the *Achillea millefolium*

Prehrambena tehnologija i biotehnologija / Food Technology and Biotechnology

aggregate are used in traditional European medicine as infusions and tinctures against gastrointestinal and hepato-biliary disorders due to their antiphlogistic, spasmolytic and antimicrobial properties. Flavonoids isolated from yarrow are described as the antispasmodic compounds and the essential oil and sesquiterpenes exhibit antimicrobial effects (Benedek et al., 2006).

In order to obtain the highest possible amount of bioactive compounds from herbal material, effective extraction procedures are required. Some of the new technologies used for bioactives extraction include maceration, percolation, Soxhlet extraction, distillation (Bart, 2011), ultrasound assisted extraction (Petigny et al., 2013; Wong Paz et al., 2015), high pressure or pressurized liquid extraction (Nagendra Prasad et al., 2009; Mustafa and Turner, 2011), microwave extraction (Nkhili et al., 2009) and supercritical CO₂ extraction (Roj, 2014; Araus et al., 2009, Jurinjak Tušek et al., 2016). All of these techniques include solid-liquid mass transfer, which is known for its complexity and dependence on the conditions used in the extraction process. Previous studies have shown that the extraction process depends upon different variables such as temperature (Wijngaard et al., 2012, Michiels et al., 2012), duration of the extraction process (Azmir et al., 2013, Gião et al. 2009), mixing degree of the extraction mixture (Manzak and Sonmezoglu, 2010) and particle size of the material used in the extraction process (Brewer et al., 2014; Luthria et al., 2008). Mathematical modelling and experiment design has also been proven to be a useful tool in extraction optimization (Piwowarska and Gonzalez-Alvarez, 2012).

The aim of this paper was to optimize and define the effect of extraction conditions on extraction yield, total polyphenolic content and antioxidant capacity of yarrow. Particle size, duration of the extraction process, mixing speed and temperature were taken into account as factors influencing the water extraction of bioactive compounds from yarrow.

Materials and Methods

Preparation of plant material

Dried yarrow (*Achillea millefolium* L.) leaves were purchased from Suban d.o.o. (Strmec Samoborski, Croatia), and stored at ambient conditions until used in further experiments.

Dried plant material was ground using IKA Control Tube Mill (IKA Werke, Breisgau, Germany). Grinding speed was set to 20000 rpm and the samples were ground until desired particle size was obtained. A set of standardized DIN sieves (Retsch, Haan, Germany) with pore openings of 100, 180 and 450 µm were used together with a laboratory sieve shaker (Retsch, Haan, Germany) to separate different particle size fractions of the plant material. These particle size fractions were then used in the extraction process.

Experimental design

Taguchi experimental design was used to define a set of nine experiments shown in Table 1.

Table 1. Taguchi orthogonal array used for extraction experiment design

	$T/^\circ\text{C}$	Particle size / μm	t/min	rpm
exp1	40	< 100	30	250
exp2	40	280 - 450	60	500
exp3	40	3000 - 4000	90	750
exp4	60	< 100	60	750
exp5	60	280 - 450	90	250
exp6	60	3000 - 4000	30	500
exp7	80	< 100	90	500
exp8	80	280 - 450	30	750
exp9	80	3000 - 4000	60	250

Extraction was conducted in an IKA Hbr 4 Digital water bath (IKA Werke, Breisgau, Germany) at process conditions shown in Table 1. Extraction yield, antioxidant capacity and total polyphenolic content were used as response (or dependant) variables.

Extraction yield

Extraction yield was expressed as the dry matter content of the extracts. Dry matter was determined by a standard AOAC method (AOAC 1990). Approximately 3 g of extracts were dried for $t = 4$ hours at $T = 105^\circ\text{C}$ in weighing dishes previously filled with quartz sand. All measurements were done in triplicate.

Total polyphenolic content

Total polyphenolic content (TPC) of prepared extracts was determined spectrophotometrically by the Folin-Ciocalteu reagent, according to a modified method of Lachman et al. (1998). All determinations were carried out in triplicates and the results were expressed as mg gallic acid equivalents (GAE)/g of dry matter (d. m.) of plant material.

Antioxidant capacity

Antioxidant capacity of the extracts was determined by three commonly used methods: ABTS, DPPH and FRAP, as described previously by Benzie and Strain (1996), Re et al. (1999) and Brand-Williams et al. (1995).

Statistical analysis

Factorial MANOVA was used to assess the influence of specific process parameters on the response variables. Differences between results have to be significant at least on $p < 0.05$, to be accepted as reliable.

Results and Discussion

Extraction yield

Extraction yields for all nine experiments designed using the Taguchi orthogonal array are shown in Fig. 1.

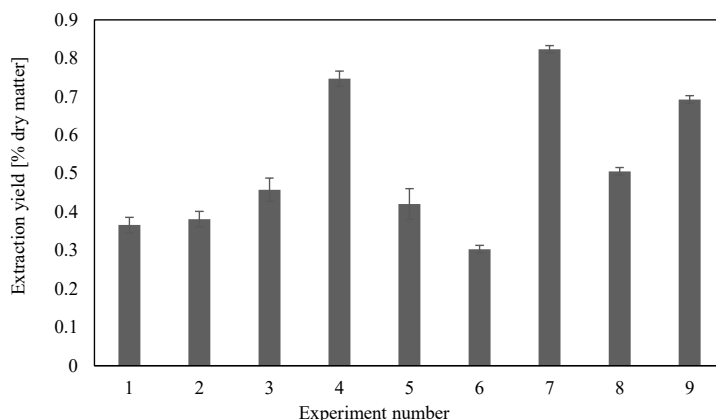

Fig. 1. Extraction yields shown as dry matter content for nine experiments conducted in this study. Values are shown as mean \pm SD.

Experiments 1, 2 and 6 resulted in the lowest extraction yield (Fig. 1). Experiments 1 and 2 were both conducted at a low extraction temperature ($T = 40$ °C) for 30 and 60 min, which proved to be too low for better extraction yield. In the case of experiment 3, conducted at the same temperature, extraction yield was better, which means that the lower temperature can be compensated by a longer duration of the extraction process. In the case of experiments conducted at $T = 60$ °C (exp. 4, exp. 5, and exp. 6), 60 minutes and 750 rpm for the smallest particle size fraction (< 100 μm) proved to be sufficient to yield the highest dry matter content. The highest extraction yield was observed for experiment 7 with the following process conditions: $T = 80$ °C, particle size fraction < 100 μm , 90 min and 500 rpm. Based on the following results, particle size, rotational speed, duration of the process and temperature all have a simultaneous influence on the dry matter content of the extracts and have to be observed in combination to get a good insight into the extraction process.

Total polyphenolic content

Spectrophotometrically determined total polyphenolic content for nine yarrow extracts is shown in Fig. 2.

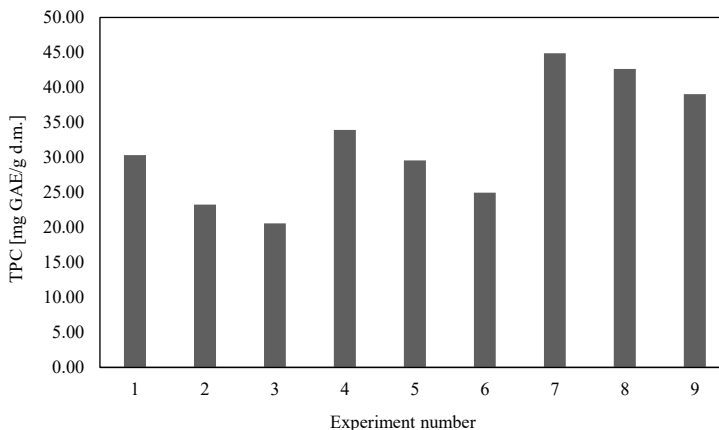

Fig. 2. Total polyphenolic content of yarrow extracts. Results are shown as mean \pm SD.

As seen in Fig. 2, temperature had the highest influence on total polyphenolic content of yarrow extracts. First three experiments conducted at $T = 40\text{ }^{\circ}\text{C}$ resulted in much lower polyphenolic content in comparison to those conducted at $T = 80\text{ }^{\circ}\text{C}$ (experiments 7, 8 and 9). The same as in the case of extraction yield, conditions used in experiment 7 proved to be optimal for total polyphenolic extraction from yarrow. Influence of particle size on total polyphenolic content is also visible. Ground plant material with lower particle sizes exhibited higher total polyphenolic contents.

Antioxidant capacity

Values of antioxidant capacity of yarrow extracts determined by all three methods are shown in Fig. 3.

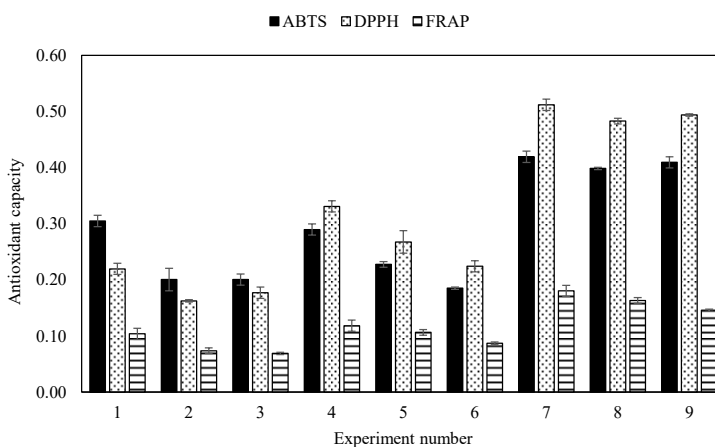

Fig. 3. Antioxidant capacity of yarrow extracts. Results are shown as mean \pm SD.

Prehrambena tehnologija i biotehnologija / Food Technology and Biotechnology

Similar as with polyphenols, extraction temperature had the highest influence on extractability of antioxidative compounds. The highest content of antioxidants was detected in extracts 7, 8 and 9, which were extracted at a temperature of $T = 80$ °C. Influence of particle size was also visible: experiments 1, 4 and 7 conducted with particle size fractions < 100 μm showed higher antioxidant capacity.

Statistical analysis

Effect of all extraction conditions on extraction yield, total polyphenolic content and antioxidant capacity has been estimated by Factorial MANOVA. Results of the statistical analysis are shown in Table 2.

Table 2. Factorial MANOVA. Different letters in the same column represent a statistically significant difference ($p < 0.05$).

Experiment number		Extraction yield	TPC	ABTS	DPPH	FRAP
Temperature [°C]	40	0.41±0.04 ^a	24.73±4.53 ^a	0.24±0.06 ^a	0.19±0.04 ^a	0.04±0 ^a
	60	0.5±0.21 ^b	29.48±4.03 ^b	0.23±0.05 ^a	0.28±0.04 ^b	0.05±0.01 ^b
	80	0.68±0.14 ^c	42.18±2.75 ^c	0.41±0.02 ^b	0.49±0.02 ^c	0.06±0.02 ^c
Particle size [μm]	< 100	0.65±0.22 ^a	36.38±6.84 ^a	0.34±0.07 ^a	0.36±0.13 ^a	0.04±0 ^a
	280 - 450	0.44±0.06 ^b	31.82±8.84 ^b	0.28±0.1 ^b	0.3±0.14 ^b	0.06±0.01 ^b
	3000 - 4000	0.49±0.18 ^c	28.19±8.63 ^c	0.27±0.11 ^b	0.3±0.15 ^b	0.05±0.01 ^c
Time [min]	30	0.4±0.09 ^a	32.64±8.12 ^a	0.3±0.1 ^a	0.32±0.13 ^a	0.05±0.02 ^a
	60	0.61±0.18 ^b	32.08±7.2 ^a	0.3±0.1 ^a	0.33±0.14 ^a	0.05±0.01 ^a
	90	0.57±0.2 ^c	31.68±11.01 ^a	0.28±0.11 ^a	0.32±0.16 ^a	0.04±0.01 ^b
rpm	250	0.5±0.16 ^a	32.98±4.73 ^a	0.31±0.08 ^a	0.33±0.12 ^a	0.05±0.01 ^a
	500	0.51±0.25 ^a	31.03±10.78 ^a	0.27±0.12 ^b	0.31±0.16 ^b	0.04±0.01 ^b
	750	0.58±0.14 ^b	32.39±9.93 ^b	0.3±0.09 ^a	0.33±0.14 ^a	0.05±0.02 ^a

Based on statistical analysis, significant influence of temperature, particle size and duration of the extraction process has been detected on the dry matter content of the extracts. The effect of particle size on the extraction process was well investigated in previous studies, but the conclusions drawn were rather different, since those studies used different compounds and extraction methods. E.g. Maksimović et al. (2012), Gião et al. (2009) and Luthria (2008) concluded that smaller particle size also means better extraction of bioactives. Brewer et al. (2014) concluded there was no significant effect of particle size on the extraction of phytochemicals, while Wei and Yang (2014) concluded that smaller particle sizes benefit the extraction process but only to a certain extent. Namely, if particle size is decreased below a certain point, fine particles begin to form lumps which slow down the mass transfer during extraction. The results of this study indicate that lower particle size favours the extraction yield. Effect of particle size was also evident on TPC content and antioxidant capacity determined by the FRAP method.

Temperature had a significant influence on all analysed values, with the exception of antioxidant capacity determined by DPPH method. This study confirms previous research by Michiels et al.

(2012) who concluded that higher temperatures mean better extractability, where special account has to be taken on the thermal stability of the compound being extracted.

Influence of the duration of extraction process was evident only in the case of extraction yield, while rotational speed had no significant influence on the extraction process.

Conclusions

Based on the results obtained by this study, optimal extraction conditions for bioactives extraction from yarrow are: $T = 80$ °C, particle size < 100 μm , 90 min and 500 rpm. Temperature, duration, particle size and mixing speed have a simultaneous influence on the extraction yield, total polyphenolic content and antioxidant capacity of yarrow extracts.

Acknowledgment: This study is a contribution to the project „Application of microreactors in the analysis of antioxidant activity of medicinal plants (MICRO-AA)“, project number HR.3.2.01-0069, which is funded by the European Social Fund (ESF) through the Human Resources Development program.

References

- AOAC International (1990) Official Methods of Analysis, 15th edition, Association of Official Analytical Chemists, Arlington.
- Araus, K., Uquiche, E., del Valle, J.M. (2009): Matrix effects in supercritical CO₂ extraction of essential oils from plant material. *J. Food Eng.* 92(4), 438 – 447.
- Azmir, J., Zaidul, I.S.M., Rahman, M.M., Sharif, K.M., Mohamed, A., Sahena, F., Jahurul, M.H.A., Ghafoor, K., Norulaini, N.A.N., Omar, A.K.M. (2013): Techniques for extraction of bioactive compounds from plant materials: A review, *J. Food Eng.* 117(4), 426-436.
- Bart, H.-J. (2011): Extraction of Natural Products from Plants – An Introduction, in: Industrial Scale Natural Products Extraction, Bart, H.-J., Pilz S. (Eds), Weinheim, Germany: Wiley-VCH Verlag GmbH & Co. KGaA, pp. 1 - 25.
- Benedek, B., Geisz, N., Jäger, W., Thalhammer, T., Kopp, B. (2006): Choleric effects of yarrow (*Achillea millefolium* L.) in the isolated perfused rat liver, *Phytomedicine*, 13 (9–10), 702-706.
- Benzie, I. F., Strain, J. J. (1996): The ferric reducing ability of plasma (FRAP) as a measure of 'antioxidant power': the FRAP assay, *Anal. Biochem.* 239, 70-76.
- Brand-Williams, W., Cuvelier, M.E., Berset, C. (1995): Use of a free radical method to evaluate antioxidant activity, *LWT - Food Sci. Technol.* 28, 25 – 30.
- Brewer, L.R., Kubola, J., Siriamornpun, S., Herald, T.J., Shi, Y.-C. (2014): Wheat bran particle size influence on phytochemical extractability and antioxidant properties, *Food Chem.* 152, 483-490.
- Gião, M.S., Pereira, C.I., Fonseca, S.C., Pintado, M.E., Malcata, F.X. (2009): Effect of particle size upon the extent of extraction of antioxidant power from the plants *Agrimonia eupatoria*, *Salvia* sp. and *Satureja montana*, *Food Chem.* 117 (3), 412-416.

Prehrambena tehnologija i biotehnologija / Food Technology and Biotechnology

- Jurinjak Tušek, A., Benković, M., Belščak-Cvitanović, A., Valinger, D., Jurina, T., Gajdoš Kljusurić, J. (2016): Kinetics and thermodynamics of the solid-liquid extraction process of total polyphenols, antioxidants and extraction yield from *Asteraceae* plants, *Ind. Crop. Prod.* 91 (30), 205-214.
- Lachman, J., Hosnedl, V., Pivec V., Orsak, M. (1998): Polyphenols in cereals and their positive and negative role in human and animal nutrition. In: Proceedings of Cereals for Human Health and Preventive Nutrition, Vaculová, K., Ehrenbergerová, J. (eds.), Brno, CZ, pp.118–125.
- Luthria, D.L. (2008): Influence of experimental conditions on the extraction of phenolic compounds from parsley (*Petroselinum crispum*) flakes using a pressurized liquid extractor, *Food Chem.* 107 (2), 745-752.
- Maksimović, S., Ivanović, J., Skala, D. (2012): Supercritical extraction of essential oil from mentha and mathematical modelling– the influence of plant particle size, *Procedia Eng.* 42, 1767-1777.
- Manzak, A., Sonmezoglu, M. (2010): Extraction of acetic acid from aqueous solution by emulsion type liquid membranes using Alamine 300 as a carrier, *Ind. J. Chem. Technol.* 17, 441 – 445.
- Michiels, J.A., Kevers, C., Pincemail, J., Defraigne, J.O., Dommès, J. (2012): Extraction conditions can greatly influence antioxidant capacity assays in plant food matrices, *Food Chem.* 130 (4), 986-993.
- Mustafa, A., Turner, C. (2011): Pressurized liquid extraction as a green approach in food and herbal plants extraction: A review, *Anal. Chim. Acta.* 703(1), 8 – 18.
- Nagendra Prasad, K., Yang, E., Yi, C., Zhao, M., Jiang, Y. (2009): Effects of high pressure extraction on the extraction yield, total phenolic content and antioxidant activity of longan fruit pericarp. *Inn. Food Sci. & Emerg. Technol.* 10(2), 155 – 159.
- Nkhili, E., Tomao, V., El Hajji, H., El Boustani, E.-S., Chemat, F., Dangles, O. (2009): Microwave-assisted water extraction of green tea polyphenols, *Phytochem. Anal.* 20, 408 – 415.
- Petigny, L., Périno-Issartier, S., Wajzman, J., Chemat, F. (2013): Batch and continuous ultrasound assisted extraction of boldo leaves (*Peumus boldus* Mol.), *Int. J. Mol. Sci.* 14, 5750 – 5764.
- Piwowarska, N., González-Alvarez, J. (2012): Extraction of antioxidants from forestry biomass: Kinetics and optimization of extraction conditions, *Int. J. Mol. Sci.* 43, 42 – 51.
- Re, R., Pellegrini, N., Proteggente, A., Pannala, A., Yang, M., Rice-Evans, C. (1999): Antioxidant activity applying an improved ABTS radical cation decolorisation assay, *Free Radic. Biol. Med.* 26, 1231-1237.
- Roj, E. (2014): Supercritical CO₂ extraction and its application. Polish Foundation of the Opportunities Industrialization Centers "OIC Poland", Lublin.
- Wei, M.C., Yang, Y.C. (2014): Extraction characteristics and kinetic studies of oleanolic and ursolic acids from *Hedyotis diffusa* under ultrasound-assisted extraction conditions, *Sep. Purif. Technol.* 130, 182-192.
- Wijngaard, H., Hossain, M.B., Rai, D.K., Brunton, N. (2012): Techniques to extract bioactive compounds from food by-products of plant origin, *Food Res. Int.* 46(2), 505-513.
- Wong Paz, J.E., Muñoz Márquez, D.B., Martínez Ávila, G.C.G., Belmares Cerda, R.E., Aguilar, C.N. (2015): Ultrasound-assisted extraction of polyphenols from native plants in the Mexican desert, *Ultrason. Sonochem.* 22, 474 – 481.

Original research paper

In vitro* antibacterial activity of essential oils on *Staphylococcus aureus* and *Escherichia coli

Marina Palfi^{1*}, Vesna Mihaljević-Herman¹, Jasenka Ćosić², Vesna Popijač¹,
Nina Puhač Bogadi¹

¹Podravka d. d., Ante Starčevića 32, 48000 Koprivnica, Croatia

²Josip Juraj Strossmayer University of Osijek, Faculty of Agriculture in Osijek,
Kralja Petra Svačića 1d, 31000 Osijek, Croatia

*Corresponding author: marina.palfi@podravka.hr

Summary

This study examines the impact of essential oils of thyme (*Thymus vulgaris* L.), clove (*Eugenia caryophyllus* (Sprengel) Bullock and Harr.) and sage (*Salvia officinalis* L.) on *Escherichia coli* and *Staphylococcus aureus* in vitro by disc diffusion with three different volumes of oil (5 µL, 10 µL and 15 µL). Measuring the diameter of inhibition zone of bacterial growth was carried out after 24 h. A statistically significant difference in the inhibitory effects of essential oils and applied volumes was found. The best results were found in essential oil of thyme, in which the largest inhibitory zone with both bacteria was measured. The essential oil of thyme completely inhibited the growth of *S. aureus* at a volume of 10 µL. Apart from the essential oil of thyme, the complete inhibition of growth of *S. aureus*, with a volume of 15 µL, was shown in sage essential oil. The essential oil of clove showed a minimum inhibitory activity in both bacteria in all three volumes.

It is necessary to continue the researches with the assumption that the results of the researches can be used in the food industry.

Keywords: essential oils, *Escherichia coli*, *Staphylococcus aureus*, inhibitory activity

Introduction

Resistance to antibiotics has become a public health issue which has steered research towards new and innovative antimicrobial agents (Högberg et al., 2010). Along with the inaccurate use of antibiotics, there is also a great number of mutating bacteria which disable the effects of microbial substances (Cantón and Morosini, 2011).

Escherichia coli and *Staphylococcus aureus* are just some of the bacteria which cause foodborne diseases (Prange et al., 2005) and can lead to severe infections and deaths in sensitive populations (Ibrahim et al., 2008; Li et al., 2008; Budimir et al., 2012). Pathogens transmitted by food are causing an increasing interest of researchers and consumers. The increased need to develop new methods for fighting the foodborne pathogens is especially growing in the organic food segment (Theron and Lues, 2007) and in minimally processed food. Reducing or eliminating chemical

Prehrambena tehnologija i biotehnologija / Food Technology and Biotechnology

preservatives in food and replacing them with natural alternatives has become a trend in the food industry, due to the increased pressure from the consumers and legislation.

Many natural compounds found in plants have proven to have an anti-microbial effect against foodborne pathogens (Boukhatem et al., 2013). Essential oils are secondary plant metabolites and are important for plant defense and due to its antimicrobial activity, they are increasingly used as natural preservatives (Burt, 2004; Fisher and Phillips, 2006; Bakkali et al., 2008; Tajkarimi et al. 2010) especially because consumers have a negative perception of synthetic preservatives (Küçükbay et al., 2014). Researchers are getting more and more interested in using essential oils as alternatives for synthetic chemicals (Bakkali et al., 2008; Hyldgaard et al., 2012; Turgis et al., 2012; Teixeira et al., 2013).

Chemical composition of essential oils is complex and depends on the type of a plant, part of the plant it is extracted from, origin, harvest time, harvest and processing season as well as storage conditions (Burt, 2004; Tajkarimi et al., 2010). Essential oils can contain more than 60 different components, two or three of which are main components and are in higher concentrations, whereas all other components could be found in traces (Bakkali et al., 2008).

Antimicrobial activity of essential oils is different from one food product to the next as certain nutrients vary in food (Fisher and Phillips, 2006). For antimicrobial activity of essential oils, food products must contain higher concentrations of essential oils than in *in vitro* research. (Burt, 2004) which can influence the organoleptic product properties and cause negative feedback from consumers (Lv et al., 2011). Therefore, it is important to be careful when choosing essential oils in food production, which would fit the organoleptic properties of the product and its properties (Gutierrez, 2009).

The aim of this research is to test the impact of the antibacterial effect of commercial essential oils of thyme, clove and sage on two pathogen bacteria *Escherichia coli* (ATCC 8739) and *Staphylococcus aureus* (ATCC 6538).

Materials and Methods

The test inspected the effect of commercial essential oils of thyme (*Thymus vulgaris* L.), clove (*Eugenia caryophyllus* (Sprengel) Bullock and Harr.) and sage (*Salvia officinalis* L.) on the growth of the bacteria *Escherichia coli* (ATCC 8739) and *Staphylococcus aureus* (ATCC 6538). The essential oils were produced in Pranarôm International (Belgium) and analyzed in Pranarôm laboratory using the GC-MC (gas chromatography – mass spectrometry). The representation of the most important components of essential oils of thyme, clove and sage is shown in Table 1. The testing of antibacterial influence of the essential oils was done *in vitro* according to the modified disc diffusion method (Kalemba and Kunicka, 2003).

Table 1. Chemical composition of essential oils

Essential oils	Compounds	%
<i>Thymus vulgaris</i>	thymol	44.11
	γ -terpinene	6.94
	ρ -cimene	20.88
	linalool	4.07
	carvacrol	3.56
<i>Eugenia caryophyllus</i>	β -caryophyllene	7.46
	eugenol	82.10
	acetate d'eugenile	8.24
<i>Salvia officinalis</i>	β -pinen	7.49
	1,8-cineole	10.68
	α -thujone	34.57
	β -thujone	12.99
	β -caryophyllene	6.01
	thymol	3.23

Microorganism cultures were kept in Tryptic Soy Agar, Merck (TSA) in a refrigerator, at 4 °C. The revitalization of pure cultures was done in the Tryptic Soy Broth, Merck (TSB broth). The culture was incubated at 37 °C/18-24 h. The pre-prepared working suspension of the tested bacteria *Escherichia coli* (ATCC 8739) or *Staphylococcus aureus* (ATCC 6538) was put on Mueller Hinton Agar (plates) using a flocced swab, (decimal dilution 10^{-1} , density of the used bacterial inoculum $\sim 1,5 \times 10^7$ cfu/g). Sterilized Whatman paper disc, diameter 6 mm was in the middle of the petri dish (diameter 90 mm) with the Mueller Hinton agar base. Using a pipette, 5, 10, 15 μ L of essential oil was added to each paper disc. Petri dishes were kept in a thermostat at 37 °C, in the dark. After 24 hours, the zone of inhibition was measured around the paper disc, that is, the distance from the marginal bacteria colony to the paper disc, and it was expressed in mm.

Statistical analysis

The test was done in four sets. The statistical analysis was done using the statistical program PAST (v. 2.17) (Hammer et al., 2001). Data was assessed with the combination of a two-way and one-way analysis of variance (ANOVA). Differences were assessed by using Tukey „post-hoc“ tests. Results were considered statistically significant if $p < 0.05$.

Results and Discussion

The tested antibacterial activities of commercial essential oils of thyme, clove and sage were done on *S. aureus* and *E. coli* in *in vitro* conditions by using different volume of essential oils with the disc diffusion method.

Our research has shown that all three essential oils (thyme, clove and sage) have demonstrated a certain antibacterial effect (Table 2). The statistical analysis has identified a statistically significant difference ($p < 0.05$) in essential oils and the used volumes.

Prehrambena tehnologija i biotehnologija / Food Technology and Biotechnology

The best results were achieved with the essential oil of thyme which showed the largest zone of inhibition with all used volumes (Tables 2). The essential oil of thyme completely inhibited the growth of *S. aureus* at the used volume of 10 µL (42.00 ± 0.00 mm). The highest zone of inhibition of the essential oil of thyme for *E. coli* was 30.00 ± 1.41 mm at volume of 15 µL.

Table 2. Inhibition zone (mm) of essential oils for *S. aureus* and *E. coli*

Essential oils	Inhibition zone (mm) ^{*,**}		
	5 µL	10 µL	15 µL
	<i>S. aureus</i>		
<i>Thymus vulgaris</i>	24.00 ± 0.82 ^a	42.00 ± 0.00 ^b	42.00 ± 0.00 ^b
<i>Eugenia caryophyllus</i>	6.75 ± 0.50 ^a	8.50 ± 0.58 ^b	9.00 ± 0.82 ^b
<i>Salvia officinalis</i>	16.50 ± 1.29 ^a	26.75 ± 3.30 ^b	42.00 ± 0.00 ^c
	<i>E. coli</i>		
<i>Thymus vulgaris</i>	21.00 ± 1.41 ^a	22.50 ± 3.51 ^a	30.00 ± 1.41 ^b
<i>Eugenia caryophyllus</i>	2.25 ± 0.50 ^a	7.25 ± 0.50 ^b	9.50 ± 0.58 ^c
<i>Salvia officinalis</i>	5.25 ± 0.50 ^a	8.50 ± 1.92 ^a	17.25 ± 2.22 ^b

^{*}Results were reported as mean ± SD, n = 4.

^{**}For the results in same rows letters a, b, c represent statistical significant differences according to Tukey (p < 0.05).

The achieved results were in accordance with the testing done by Soković et al. (2010) who tested the antimicrobial activity of ten different essential oils using the disc diffusion method. The essential oils which showed the highest antibacterial activity were *T. vulgaris* (16.0 – 30.0 mm) and *O. vulgare* (20.0 – 35.0 mm). The authors tested, apart from essential oils, their components, and the results showed that the carvacrol and thymol had the highest antibacterial activity.

Similar results were achieved by Chaftar et al. (2015) who determined that the essential oil of thyme showed the broadest specter of activity and the lowest minimum inhibition concentration among all tested essential oils.

Essential oils usually have a better antibacterial activity than mixtures of their main components, which indicates that minor components have important role in synergistic activity, although antagonistic and additive effects have been noticed as well (Bassolé and Juliani, 2012). The effects of essential oils on pathogen bacteria is seen in the membrane and cytoplasm and, in some cases, they can completely alter the morphology of the bacteria cells (Nazzaro et al., 2013).

The highest zone of inhibition with the essential oil of sage *E. coli* amounted to 17.25 ± 2.22 mm (Table 2). Essential oil of sage had the full inhibition zone for *S. aureus* at used volume of 15 µL (Table 2). Moghimi et al. (2016) tested the essential oil of sage which was turned into nanoemulsion and the results showed that the antibacterial activity against *E. coli* and *S. typhi*. Their results also show that the transformation of sage into nanoemulsion improves the antibacterial activity and strengthens the ability to destroy bacterial cell membranes.

Our results for the essential oils of thyme and sage are in accordance with the results of researches showing that essential oils have a better effect on Gram-positive than on Gram-negative bacteria (Burt, 2004; Alboofetileh et al., 2014; Shirazi et al., 2014).

The least inhibitory activity on both bacteria in all three used volumes was achieved with the essential oil of clove. The *E. coli* inhibition zone for the essential oil of clove *E. coli* was from 2.25 ± 0.50 mm to 9.50 ± 0.58 mm (Table 2), and for *S. aureus* from 6.75 ± 0.50 mm to 9.00 ± 0.82 mm (Table 2). Earlier studies have shown that the clove also shows a significant bactericidal and bacteriostatic activity on various layers of *E. coli* (Moreira et al., 2005). Our results are accordant with some researches (Burt and Reinders, 2003) that determined that the essential oil of clove contains less antimicrobial activity on *E. coli* than the essential oil of thyme and oregano. Unlike the essential oil of thyme and sage, the essential oil of clove shows the highest zone of inhibition (9.50 ± 0.58 mm) on *E. coli* at used volume of 15 μ L, therefore, it was higher with Gram-negative bacteria. Similar results of testing antibacterial activity of essential oils of thyme was achieved by Anzlovar et al. (2014) who determined that the essential oil of thyme have no specific antibacterial activity on Gram-positive or Gram-negative bacteria.

Although the researches have proven the positive effect of essential oils on the prevention of bacterial growth, the use of oils depends on the organoleptic properties which are unacceptable to consumers especially as higher concentrations of essential oils are needed *in vivo*.

Conclusions

The achieved results show that the tested commercial essential oils of thyme, clove and sage contain certain antibacterial properties. The essential oil of thyme proved to be the best, with the zone of inhibition measured in all used volumes. The essential oils of thyme and sage showed better effect on Gram-positive than on Gram-negative bacteria. It is our opinion that the research should be continued in *in vivo* conditions in combinations with new techniques of use, such as nanoemulsion and active packaging ensuring the food safety and acceptable organoleptic properties.

References

- Alboofetileh, M., Rezaei, M., Hosseini, H., Abdollahi, M. (2014): Antimicrobial activity of alginate/clay nanocomposite films enriched with essential oils against three common foodborne pathogens, *Food Control* 36 (1), 1-7.
- Anzlovar, S., Baricevic, D., Avgustin, J.A., Koce, J.D. (2014): Essential Oil of Common Thyme as a Natural Antimicrobial Food Additive, *Food Technol. Biotechnol.* 52 (2), 263.
- Bakkali F, Averbeck S, Averbeck D, Idaomar, M. (2008): Biological effects of essential oils a review. *Food Chem. Toxicol.* 46 (2), 446-475.
- Bassolé, I.H.N., Juliani, H.R. (2012): Essential oils in combination and their antimicrobial properties, *Molecules* 17 (4), 3989–4006.
- Boukhatem, M.N., Kameli, A., Saidi, F. (2013): Essential oil of Algerian rose-scented geranium (*Pelargonium graveolens*): Chemical composition and antimicrobial activity against food spoilage pathogens, *Food Control* 34 (1), 208-213.
- Budimir, A., Bošnjak, Z., Kalenić, S. (2012): Meticilin-rezistentni *Staphylococcus aureus* (MRSA) u Hrvatskoj, *Infektološki Glasnik* 32 (2), 59-66.

- Burt, S. (2004): Essential oils: their antibacterial properties and potential applications in foods—a review, *Int. Journal Food Microbiol.* 94 (3), 223-253.
- Burt, S.A., Reinders, R.D. (2003): Antibacterial activity of selected plant essential oils against *Escherichia coli* O157: H7, *Lett. appl. Microbiol.* 36 (3), 162-167.
- Cantón, R., Morosini, M.I. (2011): Emergence and spread of antibiotic resistance following exposure to antibiotics, *FEMS microbial. Rev.* 35 (5), 977-991.
- Chaftar, N., Girardot, M., Labanowski, J., Ghrairi, T., Hani, K., Frère, J., Imbert, C. (2015): Comparative evaluation of the antimicrobial activity of 19 essential oils. In: *Advances in Microbiology, Infectious Diseases and Public Health, Adv. Exp. Med. Biol.* pp. 1-15.
- Fisher, K., Phillips, C.A. (2006): The effect of lemon, orange and bergamot essential oils and their components on the survival of *Campylobacter jejuni*, *Escherichia coli* O157, *Listeria monocytogenes*, *Bacillus cereus* and *Staphylococcus aureus* in vitro and in food systems, *J. Appl. Microbiol.* 101 (6), 1232-1240.
- Gutierrez, J., Barry-Ryan, C., Bourke, P. (2009): Antimicrobial activity of plant essential oils using food model media: efficacy, synergistic potential and interactions with food components, *Food microbiol.* 26 (2), 142-150.
- Hammer, Ø., Harper, D.A.T., Ryan, P.D. 2001. PAST: Paleontological statistics software package for education and data analysis. *Palaeontol. Electron.* 4:9.
- Högberg, L.D., Heddi, A., Cars, O. (2010): The global need for effective antibiotics: challenges and recent advances, *Trends Pharmacol. Sci.* 31 (11), 509-515.
- Hyldgaard, M., Mygind, T., Meyer, R.L. (2012): Essential oils in food preservation: mode of action, synergies and interactions with food matrix components, *Front. Microbiol.*, 3 (12), 1–24.
- Ibrahim, S.A., Yang, H., Seo, C.W. (2008): Antimicrobial activity of lactic acid and copper on growth of *Salmonella* and *Escherichia coli* O157: H7 in laboratory medium and carrot juice, *Food Chem.* 109 (1), 137-143.
- Kalemba, D., Kunicka, A. (2003): Antibacterial and antifungal properties of essential oils, *Curr. Med. Chem.* 10 (10): 813-829.
- Küçükbay, F.Z., Kuyumcu, E., Çelen, S., Azaz, A.D., Arabac, T. (2014): Chemical Composition of the Essential Oils of Three Thymus Taxa from Turkey with Antimicrobial and Antioxidant Activities, *Rec. Nat. Prod.* 8 (2): 110-120.
- Li, H., Tajkarimi, M., Osburn, B. I. (2008): Impact of vacuum cooling on *Escherichia coli* O157: H7 infiltration into lettuce tissue, *Appl. Environ. Microb.* 74 (10), 3138-3142.
- Lv, F., Liang, H., Yuan, Q., Li, C. (2011): In vitro antimicrobial effects and mechanism of action of selected plant essential oil combinations against four food-related microorganisms, *Food Res. Int.* 44 (9), 3057–3064.
- Moghimi, R., Aliahmadi, A., McClements, D.J., Rafati, H. (2016): Investigations of the effectiveness of nanoemulsions from sage oil as antibacterial agents on some food borne pathogens, *LWT-Food Sci. Technol.* 71, 69-76.
- Moreira, M.R., Ponce, A.G., Del Valle, C.E., Roura, S.I. (2005): Inhibitory parameters of essential oils to reduce a foodborne pathogen, *LWT-Food Sci. Technol.* 38 (5), 565-570.
- Nazzaro, F., Fratianni, F., De Martino, L., Coppola, R., De Feo, V. (2013): Effect of essential oils on pathogenic bacteria, *Pharmaceut.* 6 (12), 1451-1474.

- Prange, A., Birzele, B., Hormes, J., Modrow, H. (2005): Investigation of different human pathogenic and food contaminating bacteria and moulds grown on selenite/selenate and tellurite/tellurate by X-ray absorption spectroscopy, *Food Control* 16 (8), 723-728.
- Shirazi, M.T., Gholami, H., Kavooosi, G., Rowshan, V., Tafsiry, A. (2014): Chemical composition, antioxidant, antimicrobial and cytotoxic activities of *Tagetes minuta* and *Ocimum basilicum* essential oils, *Food Sci. Nutr.* 2 (2), 146-155.
- Soković, M., Glamočlija, J., Marin, P.D., Brkić, D., van Griensven, L.J. (2010): Antibacterial effects of the essential oils of commonly consumed medicinal herbs using an in vitro model, *Molecules* 15 (11), 7532-7546.
- Tajkarimi, M.M., Ibrahim, S.A., Cliver, D.O. (2010): Antimicrobial herb and spice compounds in food, *Food Control* 21 (9), 1199-1218.
- Teixeira, B., Marques, A., Ramos, C., Neng, N.R., Nogueira, J.M., Saraiva, J.A., Nunes, M.L. (2013): Chemical composition and antibacterial and antioxidant properties of commercial essential oils, *Ind. Crop. Prod.* 43, 587-595.
- Theron, M.M., Lues, J.F. (2007): Organic acids and meat preservation: a review, *Food Rev. Int.* 23 (2), 141-158.
- Turgis, M., Vu, K.D., Dupont, C., Lacroix, M. (2012): Combined antimicrobial effect of essential oils and bacteriocins against foodborne pathogens and food spoilage bacteria, *Food Res. Int.* 48 (2), 696-702.

Original research paper

Cytotoxic and prooxidative effect of ginger extract on human laryngeal and lung carcinoma cell lines

Ksenija Durgo, Arijana Bušić, Aleksandra Vojvodić, Ana Belščak-Cvitanović,
Marina Lisičar, Draženka Komes*

*University of Zagreb, Faculty of Food Technology and Biotechnology, Pierottijeva 6, 10000
Zagreb, Croatia*

**Corresponding author: dkomes@pbf.hr*

Summary

Nowadays, cancer has become a leading cause of fatal diseases worldwide. Recently, the emphasis is dedicated on investigation of natural, alternative remedies in treatment of cancer cell lines, where plant extracts, due to their rich bioactive composition and high biological activity, may play big role.

In this study, biological effect of aqueous ginger (*Zingiber officinale*) extract (*GE*) on the human laryngeal cancer cell line (HEp2) and lung carcinoma cells (A549) was evaluated. Cytotoxic, prooxidative effect and lipid peroxidation were examined in cancer cell lines exposed to different concentrations of *GE* for 2 hours. Cell survival was determined by Neutral red test, while 2',7'-dichlorofluorescein-diacetate (DCFH-DA) method was used for determination of free radicals. Lipid peroxidation was evaluated by measuring concentration of generated malondialdehydes.

GE showed significant ($p < 0.05$) decrease in cell survival for HEp2 and A549 in the highest concentration of 10 mg/mL, while lower concentrations (5 mg/mL and 1 mg/mL) did not show cytotoxic effect. *GE* did not exhibit prooxidative effect on both cell lines, where by increasing the extract concentration free radical induction was decreased. Moreover, *GE* did not reveal effect on cell lipids in A549 line, while in HEp2 cell line *GE* in concentration of 5 mg/mL caused lipid peroxidation. Obtained results confirmed markable health benefits of *GE* and justified its wide application in various pharmaceutical and food products.

Keywords: cytotoxicity, ginger, laryngeal and lung carcinoma cell lines, lipid peroxidation, prooxidative effect

Introduction

Today, carcinoma is a major threat to human health and is a leading cause of morbidity and mortality globally. Carcinoma could be described by the uncontrolled proliferation of undifferentiated cells, resulting in the invasion of surrounding tissues and metastasis of other organs (Zong et al., 2011). Chemotherapy is one of the most common cancer treatments. However, its therapeutic outcome is often unsatisfactory due to the serious and intolerable side effects, and therefore emphasis is put on the development of new selective anti-tumor compounds of low toxicity towards non-transformed cells (Liu et al., 2014). Also, extremely big, unsolved problem in

the cancer treatment is a resistance to combination of medication, when cancer cells lose their sensitivity to the complex structural differences of various chemotherapeutic agents (Falasca and Linton, 2012). On the other side, plant-derived secondary metabolites have low potency as bioactive compounds in comparison to synthetic drugs, but since they are ingested regularly and in significant amounts as part of the diet, they may provide long-term physiological benefits without any side effects (Espin et al., 2007). In this regard, exhaustive search for the new drugs derived from plant secondary metabolites, that will make cancer cells sensitive to the active medicinal drug (e.g. by inhibiting P-glycoprotein), gained much interest among scientists, and recently become an important area of many investigations (Berdowska et al., 2013). Numerous studies carried out on cultured cells, animal models and human clinical trials have demonstrated the protective role of polyphenols from food in different types of cancer (Cui et al., 2010; Singh et al., 2010). Anti-cancer effects of polyphenolic-rich medicinal plants, such as herbs and spices, arises through different mechanisms, like increasing endogenous protective enzymes, protecting DNA from free radical-induced structural damage, encouraging the self-destruction of aberrant cells (apoptosis) and inhibiting tumor growth (Hedges and Lister, 2007). According to National Cancer Institute, several commonly used aromatic plants have been identified as possessing cancer-preventive properties. These plants include members of the *Lamiaceae* family like basil, mint, oregano, rosemary, sage and thyme, some of the *Apiaceae* family (caraway, cumin, and fennel), and turmeric and ginger from the *Zingiberaceae* family (Škrovánková et al., 2012). Ginger rhizome (*Zingiber officinale* Roscoe) is used worldwide both as a spice and a medicinal herb, and for centuries it has been an important ingredient in Eastern traditional medicine. Within particular phytochemical profile of ginger, the hydrophobic portion of ginger extract contains mainly different kinds of monoterpenes, oxygenated monoterpenes, sesquiterpenes, zingerone, paradols, gingerols and shogaols other than essential oils (Saha et al., 2003), while less investigated hydrophilic portion of ginger is mostly consisted of polyphenolic compounds (Kato et al., 2006). Numerous studies demonstrated that ginger or its extracts exhibit certain pharmacological activity, including anti-inflammation, analgesic effect, anti-tumor and antioxidant activity (Dugasani et al., 2010). For example, [6]-gingerol treatment in colorectal cancer cells exhibited mitochondrial damage and inhibition of cell survival pathways (Lee et al., 2008). In a study of Kota et al. (2008), oral consumption of ginger increased antioxidant levels and reduced oxidative damages in the liver and kidney of rats. Chang et al. (2013) determined anti-viral activity of fresh ginger against human respiratory syncytial virus in human respiratory tract cell lines. Also, aqueous ginger extract inhibited proliferation and angiogenesis of colonic adenocarcinoma cells (Brown et al. 2009), while ginger polyphenols induce apoptotic, cytotoxic and antioxidant effects in hepatoma cells (Hessien et al., 2013).

The aim of this study was firstly to prepare different aqueous ginger extracts and evaluate their insufficiently investigated bioactive profile, in terms of polyphenolic compounds and antioxidant activity, where the extract with the highest yield of polyphenolics was chosen for the determination of its biological activity. Cytotoxic, prooxidative effect and lipid peroxidation were examined in human laryngeal (HEp2) and lung (A549) carcinoma cell lines after the exposure to different concentrations of ginger extract in duration of 2 hours. Also, the results of this study will reveal possible link between the bioactive profile and biological effects of ginger extract on human laryngeal (HEp2) and lung (A549) carcinoma cells.

Materials and Methods

Preparation of aqueous ginger extracts for determination of bioactive profile and biological activities

Fresh ginger root (*Zingiber officinale*) was purchased in a local store, washed, peeled, grated and dried in a drying oven at 60 °C. After drying, samples were ground to desired particle size in electric mill and used to prepare extracts by two conventional extraction techniques.

First extraction technique (*GE 1*) was carried out at room temperature by pouring 200 mL of boiled distilled water over the 10 g of sample, and stirred with a glass rod for 30 minutes, without maintaining the water temperature. Using second extraction technique (*GE 2*), again 10 g of sample was extracted in 200 mL of distilled water heated up to 80 °C, and stirred with a glass rod for 15 minutes, while maintaining the water temperature during whole extraction time. After both extractions, the extracts were firstly filtered through a tea strainer, centrifuged, filled up with water to desired volume (200 mL) and cooled to room temperature.

According to the results of bioactive analyses, extract with the highest extraction efficiency of polyphenolics and highest antioxidant capacity (ginger extract prepared by second extraction technique – *GE 2*) was chosen for determination of biological activities on selected cancer cell lines. For evaluation of biological effects of *GE 2*, sterile water was used as solvent, and extraction was performed in the same way as described above. Afterwards, prepared extract was concentrated on a rotary evaporator and then freeze-dried. Obtained powder was dissolved in different volumes of growth medium, and four concentrations of extracts were prepared (0.1x, 0.5x, 1x and 2.5x). However, due to the formation of thick slurry and precipitate, the highest concentration (2.5x) of extract was discarded. Usually, herbal infusions are prepared in the ratio of 2 g of plant sample and 200 mL of hot water, thus the concentration of bioactive compounds present in such prepared infusion was marked as 1x (10 mg/mL) (i.e. normal recommended dose). Cytotoxic and prooxidative effects, as well as lipid peroxidation were determined on human laryngeal (HEp2) and lung (A549) cancer cell lines after 2 hours of treatment with different concentrations of ginger extract.

Determination of phytochemical profile of aqueous ginger extracts

Total polyphenol content (TPC) was analysed using Folin-Ciocalteu reagent, according to a modified method of Lachman et al. (1998). Based on the formaldehyde precipitation of flavonoids, total flavonoid content (TFC) was calculated as the difference between total polyphenol and nonflavonoid contents. Both results were expressed as mg gallic acid equivalents (GAE)/g of dry weight (dw). The content of flavan-3-ols was determined using the vanillin assay (VA) and the reaction with *p*-dimethylaminocinnamaldehyde (*p*-DAC) as described by Di Stefano et al. (1989). The content of flavan-3-ols was expressed as mg (+)-catechin/g dw. Method for determination of hydroxycinnamic acids (mg caffeic acid (CaffA)/g dw) was adapted from Matkowski et al. (2008). The content of total tannins was determined using casein, which is an adsorbing agent for tannins, according to the modified method of Rusak et al. (1993), and the results were expressed as mg of tannic acid (TA)/g dw. Proanthocyanidins (i.e. condensed tannins) were analysed by the procedure described by Porter et al. (1986), and expressed as mg (-)-epicatechin/g dw, while flavones and

flavonols (mg of quercetin/g dw) were determined in a reaction with aluminium chloride (Chang et al., 2002).

Ginger extracts were also examined for antioxidant capacity using three assays (ABTS, DPPH and FRAP). The Trolox equivalent antioxidant capacity (TEAC) was estimated by the ABTS radical cation decolourization assay (Re et al., 1999), while antioxidant capacity evaluated using the DPPH radical was described by Brand-Williams et al. (1995). The results were expressed as mmol Trolox equivalents/g dw. The ferric reducing/antioxidant power assay (mmol Fe(II)/g dw) was carried out according to a standard procedure by Benzie and Strain (1996).

All measurements were performed in triplicate, and the results are expressed as means±SD.

The content of soluble polysaccharides was determined according to a modified method of Wei et al. (2008), which is based on the aqueous extraction of polysaccharides and their precipitation with ethanol. The analysis was performed in triplicate and the polysaccharides yield was calculated as the polysaccharide content of extraction divided by initial sample weight, and expressed as % towards the dry mass±SD.

Determination of biological activity of ginger extracts

Cytotoxicity of ginger extract was determined by Neutral red assay, as described by Durgo et al. (2011). Briefly, after 24 h incubation, cells were treated with extract in different concentration ranges (0.1x, 0.5x, 1x) for 2 h. After treatment, the NR assay was carried out, as described by Babich and Borenfreund (1990). Cell viability was calculated using the following equation:

$$\% \text{ cell viability} = \text{ABS}_{\text{sample}} / \text{ABS}_{\text{ctrl}} \times 100\% \quad (1)$$

where $\text{ABS}_{\text{sample}}$ is the absorbance of cells treated with extracts and ABS_{ctrl} is the absorbance of corresponding vehicle control (growth medium).

Prooxidative activity, i.e. ROS (Reactive oxygen species) formation in the cells after the treatment with plant extract for 2 h was determined by 2',7'-dichlorofluorescein-diacetate (DCFH-DA) fluorometric assay (Silveira et al., 2003), and the results (prooxidative effect, %) were expressed as the product of the fluorescence and the quotient of cell survival that was calculated relative to the negative control (medium), as described by Komes et al. (2016).

The lipid peroxidation was measured in cells, which were exposed to various concentrations of ginger extract during the 2 h period, by determination of generated malondialdehyde (MDA) concentration ($\mu\text{M}/\text{mg}$ of proteins) according to a modified method described by Ohkawa et al. (1979), as presented in a work of Komes et al. (2016).

All measurements for biological determination were repeated in duplicate.

Statistical analysis

The results were analysed statistically using the Statistica 7.0 software to determine the average value and standard error. One-way ANNOVA variance analysis, using the Scheffe post hoc test, with a significance level of $\alpha = 0.05\%$, was performed to determine the influence of different concentrations of ginger extract on human laryngeal (HEp2) and lung (A549) cancer cell lines. Statistical analysis is determined separately for HEp2 and A549 cell lines, and significance level for each cell line should be considered apart.

Results and Discussion

Phytochemical profile of ginger extracts

TPC in ginger extract prepared by first extraction technique was 4.96 mg GAE/g, while second extraction technique ensured a higher level of polyphenols and amounted up to 5.11 mg GAE/g (Table 1).

Table 1. The effect of different aqueous extraction techniques on bioactive profile of ginger

	GE 1	GE 2
<i>Polyphenolic compounds</i>		
Total polyphenol content (mg GAE/g)	4.96±0.02	5.11±0.07
Total flavonoid content (mg GAE/g)	2.12±0.00	2.34±0.02
Flavan-3-ols (VA) (mg (+)-catechin/g)	0.25±0.01	0.21±0.01
Flavan-3-ols (<i>p</i> -DAC) (mg (+)-catechin/g)	0.04±0.00	0.07±0.00
Hydroxycinnamic acids (mg CaffA/g)	2.12±0.01	2.33±0.00
Tannins (mg TA/g)	0.12±0.02	0.09±0.02
Proanthocyanidins (mg (-)-epicatechin/g)	1.39±0.13	1.58±0.23
Flavons and flavonols (mg quercetin/g)	0.51±0.00	0.56±0.00
<i>Antioxidant capacity</i>		
ABTS (mmol Trolox/g)	0.03±0.00	0.03±0.00
DPPH (mmol Trolox/g)	0.12±0.01	0.28±0.02
FRAP (mmol Fe(II)/g)	0.06±0.00	0.07±0.00
<i>Fibre content</i>		
Soluble polysaccharides* (%)	9.19±0.01	

*determined from raw plant material

The same pattern was observed for TFC, which comprised up to 45% of total polyphenols. Obtained results indicated that higher temperature (100°C) and longer extraction time (30 min), used in first extraction technique (*GE 1*), led to the more pronounced degradation of polyphenolic compounds when compared to second extraction technique (*GE 2*). Similar results were reported in a study of Belščak-Cvitanović et al. (2014). Authors by employing higher temperatures of solvent (water) used for the extraction of polyphenols from ground ivy and hawthorn also determined lower content of polyphenols, what is consistent with results obtained in our study. In general, the concentration of polyphenols strongly depends upon extraction technique and its parameters, like extraction solvent, temperature of solvent and extraction time, as reported by many authors. Cai et al. (2004) evaluated the impact of extraction solvent on polyphenolic content of ginger, where extraction of dried ginger at 80 °C during 20 minutes using water as solvent resulted with 3.8 mg GAE/g, while methanolic extraction ensured significantly higher concentration of polyphenols, with 7.4 mg GAE/g. However, both results are consistent with ones obtained in our study. Methanol, which is more selective than water, is considered to be highly effective for extraction of polyphenolic compounds from aromatic plants (Shan et al., 2005). On the other hand, during extraction from dried material, better results were obtained when higher water content in organic solvent was used (Robards, 2003; Bimakr et al., 2011), since water increases diffusion process and makes extraction process of polyphenols from plant material much easier. However, since obtained extract was subjected to biological activities analyses, water as extraction solvent was only appropriate solution in this study. Furthermore,

Gümüşay et al. (2015) obtained 3.5 mg GAE/g d.m. in methanolic extracts of ginger dried in the oven. In our study, drying of ginger in the oven at 60 °C resulted with higher content of polyphenols in comparison to the results of Gümüşay et al. (2015).

Moreover, flavan-3-ols in ginger were determined in higher proportions when using vanillin assay, what is not surprising, since vanillin reacts with higher number of hydroxyl groups in the flavan-3-ol molecules than *p*-DAC reagent. In general, employing lower temperature of extraction solvent resulted with higher content of evaluated polyphenolic groups, with certain exceptions (flavan-3-ols (*VI*) and tannins), as reported in Table 1.

Due to differences in the mechanisms of reaction of natural antioxidants and the lack of a standardized methodology, antioxidant capacity of ginger was evaluated using three *in vitro* methods (ABTS, DPPH and FRAP). In general, the results of antioxidant capacity followed the results for determination of polyphenolic compounds, especially in the case of DPPH, where again lower temperature of extraction solvent and shorter extraction time (*GE* 2) enabled higher antioxidant capacity. The highest antioxidant capacity in aqueous ginger extracts was measured using DPPH radical (0.28 and 0.12 mmol Trolox/g), followed by FRAP (0.07 and 0.06 mmol Fe(II)/g) and ABTS assays (both extracts 0.03 mmol Trolox/g), as presented in Table 1. Similar results were obtained by Maizura et al. (2010) using FRAP assay, and in the study of Przygodzka et al. (2014) by ABTS method.

Soluble polysaccharide content in dried ginger amounted up to 9.19 %.

Biological activity of ginger extract on HEP2 and A549 cell lines

Important question that rises from the fact that ginger extract is abundant in different compounds which possess certain antioxidant activity is what the influence of such extract on living system is. Application of different test systems *in vitro* can help to reveal their biological activity once when they are in the contact with living cells. For that purpose, ginger extract was tested on two human cell lines; human laryngeal cells (HEP2) and lung cancer cells (A549) after 2 hours of treatment. According to the obtained results, ginger extract caused statistically significant ($p < 0.05$) decrease in cell survival at concentrations which are expected to be introduced to the body (1x), for both cell lines. However, lower concentrations (0.1x and 0.5x) did not cause any cytotoxic effect (Fig. 1), even there was significant difference ($p < 0.05$) among concentrations 0.1x and 0.5x. Hessein et al. (2013) determined significant inhibition of cell survival at concentrations higher than 40 µg/mL after 48 hours of treatment of liver cancer cells with polyphenols from ginger. Vijaya Padma et al. (2007) also determined similar effect on larynx cancer cell lines.

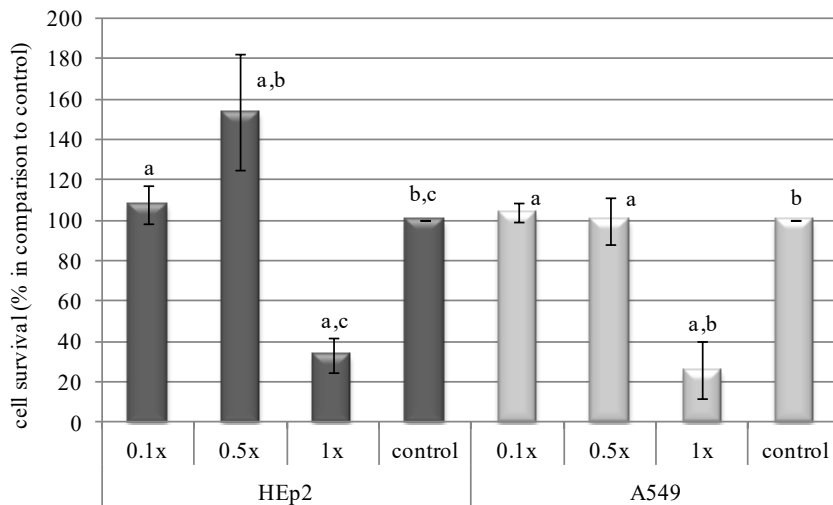

Values superscripted with the same letters are significantly ($p < 0.05$) different.

Statistical analysis is determined separately for cell lines HEP2 (a-c) and for A549 (a-b), and significance level for each cell line should be considered apart.

Fig. 1. Survival (%) of human laryngeal (HEP2) and lung (A549) carcinoma cells after 2 h treatment with different concentrations of ginger extract

Furthermore, in this work it was determined that ginger extract did not increase free radical formation, and therefore obtained results did not show prooxidative activity for all evaluated concentrations on both HEP2 and A549 cell lines. By increasing the concentration of extract the formation of free radicals was decreased, and significant ($p < 0.05$) difference among evaluated concentrations on both cell lines was observed (Fig. 2). According to these results, ginger extract was investigated on its ability to prevent/cause lipid peroxidation.

Lipid peroxidation is the most obvious effect of oxidative stress which can be seen on biological membranes. Oxidation of the unsaturated fatty acids which are a main component of cell membranes results in aldehyde formation (like malondialdehyde), and products of lipid peroxidation can be measured and used as a marker of lipid damage (Hulaev and Oliver, 2006). Contrary to that, inhibition of lipid peroxidation can be connected to binding of free radicals during initiation and termination of peroxy radicals (Mhaskar et al., 2000) phenols and flavonoids (Malik et al., 2013). From Fig. 3. it can be seen that ginger extract did not cause lipid peroxidation at A549 carcinoma cell line, what is in accordance to the results of free radicals induction. Contrary, at laryngeal cells, GE in concentration of 0.5x caused significant ($p < 0.05$) lipid peroxidation. These results indicate that there is a great cell specificity, what implies need for usage of more cell lines to reveal the exact effect of biologically active compounds.

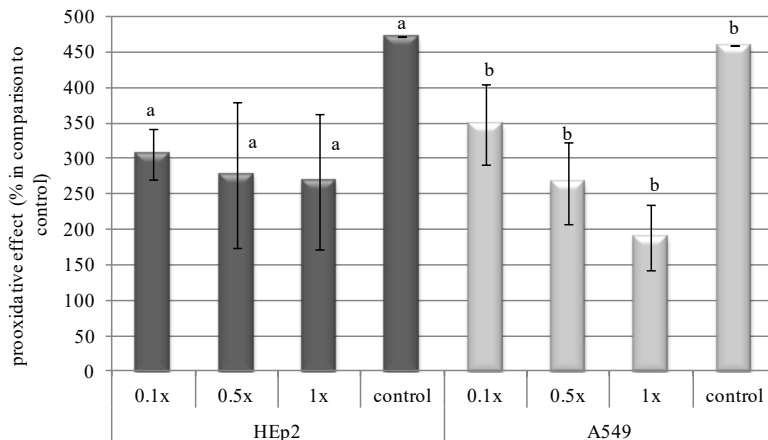

Values superscripted with the same letters are significantly ($p < 0.05$) different. Statistical analysis is determined separately for cell lines HEP2 (labelled with a) and for A549 (labelled with b), and significance level for each cell line should be consider apart.

Fig. 2. Prooxidative activity (%) of different concentrations of ginger extract on human laryngeal (HEP2) and lung (A549) carcinoma cells after 2 h treatment

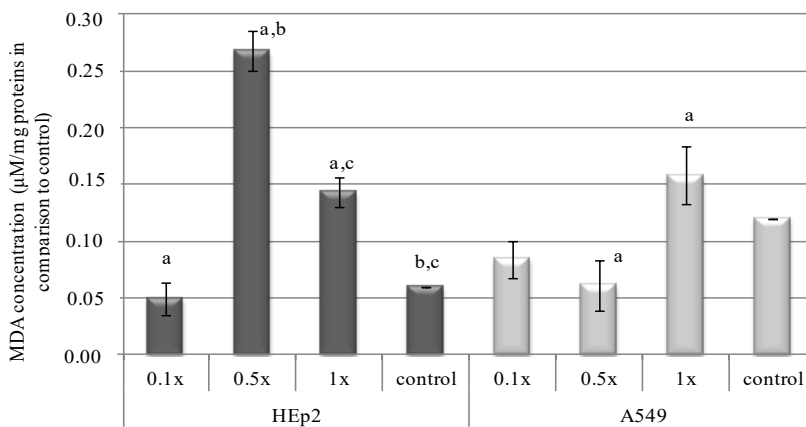

Values superscripted with the same letters are significantly ($p < 0.05$) different. Statistical analysis is determined separately for cell lines HEP2 (a-c) and for A549 (a), and significance level for each cell line should be consider apart.

Fig. 3. Concentration of generated malondialdehydes ($\mu\text{M}/\text{mg}$) after 2 h treatment of human laryngeal (HEP2) and lung (A549) carcinoma cells with different concentrations of ginger extract

Conclusions

Lower solvent temperature (80 °C) and shorter extraction time (15 min) proved to be more efficient for the extraction of ginger polyphenols. The highest concentration of ginger extract (10 mg/mL) caused statistically significant ($p < 0.05$) decrease in cell survival on human laryngeal cells (HEp2) and lung cancer cells (A549) after 2 hours of treatment, while lower concentrations of ginger extracts (1 and 5 mg/mL) did not show cytotoxic effect. Evaluated extracts in all concentrations, and on both cell lines did not exhibited prooxidative activity, and did not show any effects on lipids in lung cell line. Results pointed out ginger as a rich source of polyphenolic compounds and polysaccharides, with no side effects on the evaluated HEp2 and A549 cell lines. However, further investigations are needed to determine the mechanism of action of the mixture of these compounds, but results obtained in this work are promising and represent a ground for development of functional food that could improve human health and cell protection.

Acknowledgements: This work was supported by the Croatia-China Bilateral agreement 2015-2017.

References

- Babich, H., Borenfreund, E. (1990): Applications of the neutral red cytotoxicity assay to in vitro toxicology (Review). *Agris Records* 18, 129-144.
- Belščak-Cvitanović, A., Durgo, K., Bušić, A., Franekić, J., Komes, D. (2014): Phytochemical attributes of four conventionally extracted medicinal plants and cytotoxic evaluation of their extracts on human laryngeal carcinoma (HEp2) cells, *J. Med. Food* 17(2), 206-217.
- Benzie, I.F.F., Strain, J.J. (1996): The ferric reducing ability of plasma as a measure of "antioxidant power": The FRAP assay, *Anal. Biochem.* 239, 70-76.
- Berdowska, I., Zieliński, B., Fecka, I., Kulbacka, J., Saczko, J., Gamian, A. (2013): Cytotoxic impact of phenolics from Lamiaceae species on human breast cancer cells, *Food Chem.* 141, 1313-1321.
- Bimakr, M., Rahman, R.A., Taip, F.S., Ganjloo, A., Salleh, L.M., Selamat, J., Hamid, A., Zaidul, I.S.M. (2011): Comparison of different extraction methods for the extraction of major flavonoid compounds from spearmint (*Mentha spicata* L.) leaves, *Food Bioprod. Process.* 89, 67-72.
- Brand-Williams, W., Cuvelier, M. E., Berset, C. (1995): Use of a free radical method to evaluate antioxidant activity, *Lebensm. Wiss. Technol.* 28, 25-30.
- Brown, A.C., Shah, C., Liu, J., Pham, J.T., Zhang, J.G., Jadus, M.R. (2009): Ginger's (*Zingiber officinale* Roscoe) inhibition of rat colonic adenocarcinoma cells proliferation and angiogenesis in vitro, *Phytotherapy Res.* 23, 640-645.
- Cai, Y.Z., Luo, Q., Sun, M., Corke, H. (2004): Antioxidant activity and phenolic compounds of 112 Chinese medicinal plants associated with anticancer, *Life Sci.* 74, 2157-2184.
- Chang, C., Yang, M., Wen, H., Chern, J. (2002): Estimation of total flavonoid content in propolis by two complementary colorimetric methods, *J. Food Drug Analysis*, 10, 178-182.

- Chang, J.S., Wang, K.C., Yeh, C.F., Shieh, D.E., Chiang, L.C. (2013): Fresh ginger (*Zingiber officinale*) has anti-viral activity against human respiratory syncytial virus in human respiratory tract cell lines, *J. Ethnopharmacol.* 145, 146-151.
- Cui, X., Jin, Y., Hofseth, A.B., Pena, E., Habiger, J., Chumanevich, A., Poudyal, D., Nagarkatti, M., Nagarkatti, P.S., Singh, U.P., Hofseth L.J. (2010): Resveratrol suppresses colitis and colon cancer associated with colitis, *Cancer Prev. Res.* 3, 549-559.
- Di Stefano, R., Cravero, M.C., Gentilini, N. (1989): Metodi per lo studio dei polifenoli dei vini, *L'Enotecnico*, 1, 83-89.
- Dugasani, S., Pichika, M.R., Nadarajah, V.D., Balijepalli, M.K., Tandra, S., Korlakunta, J.N. (2010): Comparative antioxidant and anti-inflammatory effects of [6]-gingerol, [8]-gingerol, [10]-gingerol and [6]-shogaol, *J. Ethnopharmacol.* 127, 515-520.
- Durgo, K., Belščak-Cvitanović, A., Stančić, A., Franekić, J., Komes, D. (2011): The bioactive potential of red raspberry (*Rubus idaeus* L.) leaves in exhibiting cytotoxic and cytoprotective activity on human laryngeal carcinoma and colon adenocarcinoma, *J. Med. Food.* 15, 258-268.
- Espin, J.C., Garcia-Conesa, M.T., Tomas-Barberan, F.A. (2007): Nutraceuticals: facts and fiction, *Phytochemistry* 68(22-24), 2986-3008.
- Falasca, M., Linton, K.J. (2012): Investigational ABC transporter inhibitors, *Expert Opin. Investig. Drugs* 21, 657-666.
- Gümüşay, O.A., Borazan, A.A., Ercal, N., Demirkol, O. (2015): Drying effects on the antioxidant properties of tomatoes and ginger, *Food Chem.* 173, 156-162.
- Hedges, L.J., Lister, C.E. (2007): Nutritional attributes of herbs. Crop and Food Research Confidential Report No. 1891, Christchurch, New Zealand: New Zealand Institute for Crop & Food Research Limited, pp. 1-89.
- Hessien, M., Donia, T., El-Gendy, S., Sikkena, M. A. (2013): Unfractionated green tea and ginger polyphenols induce apoptotic, cytotoxic and antioxidant effects in hepatoma cells, *J. Herb. Med.* 3, 87-98.
- Hulaev, V., Oliver, D.J. (2006): Metabolic and proteomic markers for oxidative stress. New tools for reactive oxygen species research, *Plant Physiol.* 141, 367-372.
- Kato, A., Higuchi, Y., Goto, H., Kizu, H., Okamoto, T., Asano, N., Hollinshead, J., Nash, R.J., Adachi, I. (2006): Inhibitory effects of *Zingiber officinale* Roscoe derived components on aldose reductase activity in vitro and in vivo, *J. Agric. Food Chem.* 54, 6640-6644.
- Komes, D., Belščak-Cvitanović, A., Jurić, S., Bušić, A., Vojvodić, A., Durgo, K. (2016): Consumer acceptability of liquorice root (*Glycyrrhiza glabra* L.) as an alternative sweetener and correlation with its bioactive content and biological activity, *Int. J. Food Sci. Nutr.* 67 (1), 53-66.
- Kota, N., Krishna, P., Polasa, K. (2008): Alterations in antioxidant status of rats following intake of ginger through diet, *Food Chem.* 106, 991-996.
- Lachman, J., Hosnedl, V., Pivec, V., Orsák, M. (1998): Polyphenols in cereals and their positive and negative role in human and animal nutrition. In: Proceedings of the Conference - Cereals for Human Health and Preventive Nutrition, Vaculová, K., Ehrenbergerová, J. (eds.), Brno, Czech Republic: Agricultural Research Institute Kroměříž Ltd., pp. 118-125.

Prehrambena tehnologija i biotehnologija / Food Technology and Biotechnology

- Lee, S.H., Cekanova, M., Baek, S.J. (2008): Multiple mechanisms are involved in 6- gingerol induced cell growth arrest and apoptosis in human colorectal cancer cells, *Mol. Carcinog.* 47, 197-208.
- Liu, X., Sun, Z.L., Jia, A.R., Shi, Y.P., Li, R.H., Yang, P.M. (2014): Extraction, preliminary characterization and evaluation of *in vitro* antitumor and antioxidant activities of polysaccharides from *Mentha piperita*, *Int. J. Mol. Sci.* 15, 16302-16319.
- Maizura, M., Aminah, A., Wan Aida, W.M. (2010): Total phenolic content and antioxidant activity of kesum (*Polygonum minus*), ginger (*Zingiber officinale*) and turmeric (*Curcuma longa*) extract, *Int. Food Res. J.* 17, 45-53.
- Malik, B., Sharma, N.R., Soni, G. (2013): Influence of agro-climatic conditions on antioxidant potential of *Mentha* species, *J. Pharmacy Res.* 7, 427-432.
- Matkowski, A., Tasarz, P., Szypuła, E. (2008): Antioxidant activity of herb extracts from five medicinal plants from *Lamiaceae*, subfamily *Lamioideae*, *J. Med. Plants Res.* 2, 321-330.
- Mhaskar, K.S., Blatter, E., Caius, J.K. (2000): Indian Medicinal Plants, Their Usage in Ayurveda and Unani Medicines, Delhi, India: Sri Satguru Publication, pp. 2726-2727.
- Ohkawa, H., Ohishi, N., Yagi, K. (1979): Assay for lipid peroxidation in animal tissues by thiobarbituric acid reaction, *Ann. Biochem.* 95, 351-358.
- Porter, L.J., Hrstich, L., Chan, B.G. (1986): The conversion of procyanidins and prodelphinidins to cyanidin and delphinidin, *Phytochemistry* 25, 223-230.
- Przygodzka, M., Zielińska, D., Ciesarová, Z., Kukurová, K., Zieliński, H. (2014): Comparison of methods for evaluation of the antioxidant capacity and phenolic compounds in common spices, *LWT - Food Sci. Technol.* 58, 321-326.
- Re, R., Pellegrini, N., Proteggente, A., Pannala, A., Yang, M., Rice-Evans, C. (1999): Antioxidant activity applying an improved ABTS radical cation decolorization assay, *Free Radical Biol. Med.* 26, 1231-1237.
- Robards, K. (2003): Strategies for the determination of bioactive phenols in plants, fruit and vegetables, *J. Chrom. A* 1000, 657-691.
- Rusak, G., Kuštrak, D., Maleš, Z., Pleše, N. (1993): The determination of the content of polyphenols in the aerial parts of the species *Centaurea rupestris* L. and *C. fritschii* Hayek (*Asteraceae*), *Acta Pharm.* 43, 21-125.
- Saha, S., Smith, R.M., Lenz, E., Wilson, L.D. (2003): Analysis of a ginger extract by highperformance liquid chromatography coupled to nuclear magnetic resonance spectroscopy using superheated deuterium oxide as mobile phase, *J. Chromatogr.* 991(1), 143-150.
- Shan, B., Cai, Y. Z., Sun, M., Corke, H. (2005): Antioxidant capacity of 26 spices extracts and characterization of their phenolic constituents, *J. Agric. Food Chem.* 53, 7749-7759.
- Silveira, L.R., Pereira-Da-Silva, L., Juel, C., Hellsten, Y. (2003): Formation of hydrogen peroxide and nitric oxide in rat skeletal muscle cells during contractions, *Free Radic. Biol. Med.* 35, 455-464.
- Singh, U.P., Singh, N.P., Singh, B., Hofseth, L.J., Price, R.L., Nagarkatti, M., Nagarkatti, P.S. (2010): Resveratrol (trans-3,5,40-trihydroxystilbene) induces silent mating type information regulation-1 and down-regulates nuclear transcription factor kappa B

- activation to abrogate dextran sulfate sodium-induced colitis, *J. Pharmacol. Exp. Ther.* 332, 829-839.
- Škrovánková, S., Mišurcová, L., Machů, L. (2012): Antioxidant Activity and Protecting Health Effects of Common Medicinal Plants. In: *Advances in Food and Nutrition Research*, Henry, J. (ed.), Burlington, USA: Academic press, pp. 75-139.
- Vijaya Padma, V., Christie, S.A.D., Ramkuma, K.M. (2007): Induction of apoptosis by ginger in HEP-2 cell line is mediated by reactive oxygen species, *Basic Clin. Pharmacol. Toxicol.* 100, 302-307.
- Wei, S., Van Griensven, L.J.L.D. (2008): Pro- and antioxidative properties of medicinal mushroom extracts, *Int. J. Med. Mushr.* 10, 315-324.
- Zong, A., Cao, H., Wang, F. (2011): Anticancer polysaccharides from natural resources: A review of recent research, *Carbohydr. Polym.* 90, 1395-1410.

Original research paper

Nutritional composition of garlic from organic and conventional cultivation

Jana Šic Žlabur, Sandra Voća*, Nadica Dobričević, Sanja Fabek, Antonija Franjić,
Ante Galić, Stjepan Pliestić

University of Zagreb, Faculty of Agriculture, Svetošimunska cesta 25, 10000 Zagreb, Croatia

**Corresponding author: svoca@agr.hr*

Summary

Garlic (*Allium sativum* L.) shows numerous medicinal properties and beneficial effects in preventing many diseases. Garlic cloves contains many biologically active substances, including minerals, vitamins, amino acids and polyphenolic compounds with significant antioxidant activity. On the nutritional properties and content of bioactive compounds strong influence show following factors: climatic conditions, ecotype and cultivation methods. Therefore, the main objective of this study was to determine the differences in the chemical and nutritional composition of garlic cloves from organic and conventional cultivation. Following chemical parameters were analyzed: the dry matter content (%), total soluble content (%) by refractometer (Mettler Toledo Refracto 30PX, Switzerland) total acid content (%) by potentiometric titration, pH value by digital pH meter (Mettler Toledo SevenMulti, Switzerland) the vitamin C content (mg/100 g fresh matter) by titration with 2,6-dichlorindophenol, total phenol content (total flavonoids and non-flavonoids) (mg/L) by Folin-Ciocalteu method and antioxidant capacity by ABTS method. Total phenol content was determined only in garlic samples from organic cultivation while in the analyzed garlic ecotypes from conventional cultivation content of total phenols, flavonoids and non-flavonoids was not determined. A significant difference between garlic from organic and conventional cultivation were determined for the analyzed bioactive compounds (vitamin C, total phenols). In the garlic sample from organic cultivation significantly higher value of vitamin C was determined. In a garlic sample with significantly higher content of total phenolic compounds (EU2) also significantly higher antioxidant capacity was determined.

Keywords: total phenols, vitamin C, organic cultivation, conventional cultivation, garlic

Introduction

Garlic is one of the most popular species from the Alliaceae family. Its great popularity gained mainly because of the strong healing properties that are the most attributed to allicin. Allicin, a compound from the group of organic sulfur compounds, is responsible for a strong, sharp smell of garlic, exhibits significant antioxidant, antibacterial, antifungal properties and has been proven effective in inhibiting the growth of tumor cells (Amagase et al., 2001; Bianchini and Vainio, 2001; Rainy et al., 2014). Except allicin, garlic is distinguished by the rich content of other biologically active components from minerals (especially magnesium, zinc, selenium), vitamins (C, A, B

complex), polyphenolic compounds including flavonoids and phenolic acids to proteins and polysaccharides (Amagase et al., 2001; Parađiković, 2009; Drozd et al., 2011; Rainy et al., 2014). The nutritional properties and bioactive compounds content of raw materials are influenced by many factors of which the most climatic conditions, ecotype and cultivation method. Cultivation method involves a set of agricultural practices (fertilization, harvest time, water supply and others), which significantly differs in conventional and organic cultivation. The organic cultivation presumes prohibition of the use of chemical pesticides as well as a reasonable, moderate use of fertilizers by avoiding chemicals, mineral fertilizers and their replacement with organic origin fertilizers. The scientific researches have shown that raw materials from organic cultivation show significantly better nutritional composition of those produced in conventional breeding (Worthington, 2001). Therefore, the main objective of this study was to determine the differences in the chemical and nutritional composition of garlic bulb from organic and conventional cultivation.

Materials and Methods

Plant material

In these research three samples of garlic, one from conventional breeding and two from organic cultivation was used. Garlic from conventional cultivation belongs to the ecotype 'Lučko E4', was cultivated from cloves and planting material originates from Lučko (Zagreb). The trial was a randomized complete block design with three repetitions. The planting of garlic was conducted on October 28, 2015. Plant density (19.0 plants/m²) was achieved by spaces between rows (35 cm) and within the rows (15 cm). Before planting, the organic fertilization with compost and mineral fertilizer NPK 5-20-30 was conducted. Fertilization with urea (46 % N) were performed on 21 March 2016 by the inter-row cultivation. During the garlic cultivation chemicals for control of diseases and pests were not used. The garlic harvest was conducted on 29 June 2016.

The organic cultivation of garlic was set up on eco-farm "Bio Zrno" in Habjanovec. Garlic was sown in September 2015, and during the cultivation only fertilization with organic compost was applied. Another sample of garlic from organic cultivation was purchased at the store "bio&bio", a declaration of product with eco-certification proves to be an organically grown garlic.

Determination of chemical and nutritional composition of garlic cloves

Analysis of chemical and nutritional composition of garlic cloves have been carried out at the Department of Agricultural Technology, Storage and Transport Faculty of Agriculture, University of Zagreb, and included: determination of dry matter content (%), total acids content (%), pH value, total soluble solids content (%) by standard methods (AOAC, 1995), the content of vitamin C (mg/100 g fresh matter) by titration with 2,6- dichlorindophenol (AOAC, 2002), the content of total phenols (total flavonoids and non-flavonoids) (mg/L) by Folin Ciocalteu method (Ough and Amerine, 1988) and antioxidant capacity by ABTS method (Miller et al., 1993; Re et al., 1999).

Statistical analysis

The data were statistically analyzed in the software package SAS, version 9.3 (SAS, 2010). All laboratory analysis of chemical parameters was performed in triplicate. Results were subjected to one-way analysis of variance (ANOVA). The mean values were compared by t-test (LSD), and are

Prehrambena tehnologija i biotehnologija / Food Technology and Biotechnology

considered to be significantly different at $p \leq 0.0001$. With the results in the tables are the exponents of different letters indicate significant statistical differences between the observed chemical parameters at $p \leq 0.0001$. The values of standard deviation (s) show the average deviation from the mean results for each chemical parameter.

Results and Discussion

Table 1 shows the basic chemical composition of garlic cloves from conventional and organic cultivation. By statistical analysis of data the highly significant difference ($p \leq 0,01$ and $p \leq 0,0001$) in all researched chemical parameters between the garlic samples from conventional (Lučko E4) and organic cultivation (EU1 and EU2) were determined. The highest dry matter content (42.49 %) was determined in a sample of organically grown garlic EU1 while the lowest content (34.46 %) was determined also in the garlic sample from organic cultivation, but purchased at store, EU2. Specifically, a garlic sample EU2, unlike the samples Lučko E4 and EU1 which were analyzed directly after harvesting, was stored for a longer time period and the high content of dry matter in such sample was expected. Other authors state the dry matter content of garlic cloves in range from 34 to 42 %. A relatively wide range of results is a consequence of genetic characteristics (ecotypes), climatic conditions, the cultivation location and applied agro-technical methods (Baysal et al., 2003; Dumičić et al., 2013; Dumičić et al., 2014). By comparing the results of dry matter content obtained in these research with other literature data, can be concluded that all analyzed garlic samples do not differ from the average values of dry matter content. The total acid content of analyzed garlic cloves was generally low, ranging from 0.087 (EU1) to 0,150% (EU2). The obtained results of total acid content in garlic are also expected considering to the Alliaceae family and other vegetable crops are not characterized by a high content of organic acids (Lešić et al., 2004; Katalinić, 2006; Hui et al., 2010). Due to the low values of total acidity, average pH value of the analyzed garlic samples were relatively high in the range of 5.96 (EU2) to 6.13 (Lučko E4). Based on the statistical data analysis it can be concluded that researched garlic samples significantly differ in the content of total acidity and pH values, respectively cultivation method significantly influenced on analyzed parameters. Garlic is also a rich source of polysaccharides (Amagase et al., 2001; Rainy et al., 2014) and relatively high values of total soluble solids determined in the analyzed garlic samples are not unexpected. Total soluble solids content ranged from 10.00 (Lučko E4) to 11.67 % (EU2) and by statistical analysis a highly significant statistical differences ($p \leq 0.0001$) between the researched garlic samples were determined. Based on obtained data for total acid content and total soluble solids content the ratio TST/TA was mathematically expressed. Namely, the TST/TA is an indicator of a pleasant taste, the higher the ratio of soluble solids and total acid the taste of raw material is more pleasant (Katalinić, 2006). According to the results obtained in this study, the highest ratio of TST/TA (130.10) was determined for the sample EU1 while the lowest ratio (77.63) was determined for the sample EU2.

Table 1. Basic chemical composition of garlic cloves from conventional and organic cultivation

Sample	DM (%) p≤0.0001	TA (%) p≤0.001	pH p≤0.001	TSS (%) p≤0.0001	TST/TA p≤0.0001
Lučko E4	37.49b±0.47	0.089b±0.01	6.13a±0.06	10.00c±1.00	113.26b±24.03
EU1	42.49a±0.35	0.087b±0.01	6.10a±0.04	11.33b±0.29	130.10a±9.66
EU2	34.46c±0.25	0.150a±0.01	5.96b±0.02	11.67a±1.53	77.63c±10.08

EU1- garlic from organic cultivation Bio Zrno; EU2- garlic from organic cultivation bio&bio store; DM- dry matter content; TA- total acids; TST- total soluble solids; TST/TA- ratio of total soluble solids and total acids. Different letters show significant differences between the mean values.

The results of the bioactive compounds content (vitamin C, total phenols, flavonoids, non-flavonoids) and the antioxidant capacity of a garlic samples from conventional and organic cultivation are shown in Table 2. Statistical analysis of data showed that all analyzed garlic samples are significantly different ($p \leq 0,0001$) regard to the analyzed parameters. The highest vitamin C content (11.49 mg/100 g fresh matter) was determined in the sample EU1, while the lowest content (8.29 mg/100 g fresh matter) in the sample EU2. Also, a significant difference of vitamin C content was determined between garlic from conventional (Lučko E4) and organic cultivation EU1. In organically grown garlic sample (EU1) even 22.5 % higher value of vitamin C compared to the garlic from conventional cultivation was determined. The slightly lower vitamin C content in the garlic sample garlic EU2 (organic cultivation, bought at the store) is the result of a long storage period. Vitamin C is extremely unstable and strongly influenced by environmental factors such as high temperature, light, oxygen (oxidation) that significantly affect on the degradation during prolonged periods of storage (Moser and Bendich, 1991; Combs, 2008; Parađiković et al., 2012). According to the literature data (Parađiković et al., 2012) vitamin C content of garlic samples analyzed in this study is slightly higher, especially for the sample EU1. Based on the obtained results, it can be concluded that organic cultivation of garlic showed a positive effect on increasing the yield of vitamin C which is also confirmed in other scientific researches (Worthington, 2001; Esch et al., 2010; Cardoso et al., 2011). Phenolic compounds are secondary plant metabolites which primary role is participation in the plant defense mechanism, to protect the plant from various biotic (pathogen attack, parasites and predators) and abiotic stress factors (harmful effects of ultraviolet radiation, temperature, etc.) (Dai and Mupmer, 2010; Diaz Napal et al., 2010; Kennedy and Wightman, 2011). Therefore can be concluded that when a plant is in the state of stress begins to accumulate a larger amount of phenolic compounds in the plant cells. The content of phenolic compounds of raw materials is significantly affected by various factors from genotype to the cultivation location and applied agro-technical methods (Beato et al., 2011; Drozd et al., 2011). In this study, total phenol content including total flavonoids and non-flavonoids was determined only in garlic samples from organic cultivation, in the sample EU2 was determined even 33 % higher value compared to the sample EU1. Obtained results suggest a significant difference in the content of total phenolic compounds with regard to the cultivation method. Antioxidant activity of the plant species is directly correlated with the content of vitamins and various phenolic phytochemicals such as flavonoids, glycosides, alkaloids and others which due to the suppression of the oxidation process shows a positive effect on human health (Lemus-Mondaca et al., 2012; Zayova et al., 2013).

Prehrambena tehnologija i biotehnologija / Food Technology and Biotechnology

Therefore, the plant tissues which contain higher amounts of vitamins and phenolic compounds show higher antioxidant capacity (Šic Žlabur et al., 2016). In this research, a garlic sample EU2 showed antioxidant activity with determined value of 340.84 $\mu\text{molTE/L}$, which was expected given the significantly higher amount of total phenolic compounds in comparison to the other analyzed garlic samples was obtained.

Table 2. The content of bioactive compounds and antioxidant capacity of garlic cloves from organic and conventional cultivation

Sample	Vitamin C (mg/100 g) $p \leq 0.0001$	Total phenols (mg/L) $p \leq 0.0001$	Flavonoids (mg/L) $p \leq 0.0001$	Non flavonoids (mg/L) $p \leq 0.0001$	Antioxidant capacity ($\mu\text{molTE/L}$) $p \leq 0.0001$
LučkoE4	8.92b \pm 1.10	ND	ND	ND	ND
EU1	11.49a \pm 0.94	20.68b \pm 0.43	9.74b \pm 1.12	10.94b \pm 0.94	ND
EU2	8.29c \pm 1.27	62.57a \pm 1.32	42.13a \pm 3.76	20.44a \pm 4.65	341.84 \pm 2.78

EU1- garlic from organic cultivation „Bio Zrno“; EU2- garlic from organic cultivation bio&bio store; DM- dry matter content; ND- not determined. Different letters show significant differences between the mean values.

Conclusions

The analyzed garlic samples significantly nutritionally differs regard to the cultivation method, conventional and organic. Garlic samples from organic cultivation show significantly higher values of dry matter and total soluble solids content compared to garlic sample from conventional cultivation. The total acid content and pH value is not strongly influenced by the cultivation method and between analyzed garlic samples highly significant statistical differences were not determined. The highest differences between the garlic samples from conventional and organic cultivation have been determined for vitamin C content, total phenolic compounds content (flavonoids and nonflavonoids) and antioxidant capacity. Vitamin C content was even 22.5 % higher in a garlic sample from organic cultivation (EU1) in comparison to the sample from conventional cultivation. In a garlic sample with significantly higher content of total phenolic compounds (EU2) also significantly higher antioxidant capacity was determined. Based on the above presented results can be concluded that organically grown garlic shows significantly higher nutritional quality compared to the garlic from conventional cultivation.

References

- Amagase, H., Petesch, B.L., Matsuura, H., Kasuga, S., Itakura, Y. (2001): Intake of garlic and its bioactive components, *J. Nutr.*, 131 (3s), 955S-9562S.
- AOAC (1995): Official Methods of Analysis (16 th ed.), Washington, DC: Association of Official Analytical Chemists.
- AOAC (2002): Official Methods of Analysis (17 th ed.), Washington, DC: Association of Official Analytical Chemists.

- Baysal, T., Icier, F., Ersus, S., Yıldız, H. (2003): Effects of microwave and infrared drying on the quality of carrot and garlic, *Eur. Food Res. Technol.* 218 (1), 68-73.
- Beato, V.M., Orgaz, F., Mansilla, F., Montaña, A. (2011): Changes in phenolic compounds in garlic (*Allium sativum* L.) owing to the cultivar and location of growth, *Plant Foods Hum. Nutr.* 66, 218-223.
- Bianchini, F., Vainio, H. (2001): Allium vegetables and organosulphur compounds: do they help prevent cancer, *Environ. Health Persp.* 109 (9), 893-902.
- Cardoso, P.C., Tomazini, A.P.B., Stringheta, P.C., Ribeiro, S.M.R., Pinheiro-Sant'Ana, H.M. (2011): Vitamin C and carotenoids in organic and conventional fruits grown in Brazil, *Food Chem.* 126 (2), 411-416.
- Combs, G.F. (2008): The Vitamins, Elsevier Academic Press, Burlington, USA.
- Dai, J., Mumper, R.J. (2010): Plant Phenolics: Extraction, Analysis and Their Antioxidant and Anticancer Properties, *Molecules* 15, 7313-7352.
- Diaz Napal, G.N., Defago, M., Valladares, G., Palacios, S. (2010): Response of *Epilachna paenulata* to two flavonoids, Pinocebrin and quercetin, in a comparative study, *J. Chem. Ecol.* 36: 898-904.
- Drozd, M., Thomas, M., Nowak, R. (2011): Determination of phenolic acids in raw garlic (*Allium sativum* L.) and onion (*Allium cepa* L.). In: *Annales Universitatis Mariae Curie SkŁodowska*, 24 (1), 121-127.
- Dumičić, G., Čagal, M., Urlić, B., Runjić, M., Goreta Ban, S. (2013): Komponente prinosa češnjaka (*Allium sativum* L.). In: 48th Croatian and 8th International Symposium on Agriculture, Marić, S., Lončarić, Z. (ed.), Osijek, HR, pp. 349-352.
- Dumičić, G., Pavić, Š., Ljubenković, B., Urlić, B., Žanić, K., Rako, A. (2014): Komponente prinosa lukovice ekotipova češnjaka Jadranske regije. In: 49th Croatian and 9th International Symposium on Agriculture, Marić, S., Lončarić, Z. (ed.), Osijek, HR, pp. 310-314.
- Esch, J.R., Friend, J.R., Kariuki, J.K. (2010): Determination of the Vitamin C Content of Conventionally and Organically Grown Fruits by Cyclic Voltammetry, *Int. J. Electrochem. Sci.* 5, 1464-1474.
- Hui, Y. H., Chen, F., Nollet, L.M.L. (2010): Handbook of Fruit and Vegetable Flavors, New Jersey, USA: John Wiley & Sons, pp. 751-775.
- Katalinić V. (2006). Kemija mediteranskog voća i tehnologija prerađivanja. Kemijsko-tehnološki fakultet, Split.
- Kennedy, D.O., Wightman, E.L. (2011): Herbal extracts and phytochemicals: Plant secondary metabolites and the enhancement of human brain function, *Adv. Nutr.* 2, 32-50.
- Lešić, R., Borošić J., Buturac I., Čustić M., Poljak M., Romić D. (2004): Povrćarstvo, Čakovec, HR: Zrinski.
- Miller, N.J., Diplock, A.T., Rice-Evans, C., Davies, M.J., Gopinathan, V., Milner, A. (1993): A novel method for measuring antioxidant capacity and its application to monitoring the antioxidant status in premature neonates, *Clin. Sci.* 84 (4), 407-412.
- Moser, U., Bendich, A. (1991): Vitamin C. In: Handbook of Vitamins 2nd edition, Machlin, L.J. (ed.), New York, USA: Marcel Dekker, pp. 195.
- Ough, C.S., Amerine, M.A. (1988): Methods for Analysis of Musts and Wines, Washington, USA: John Wiley & Sons.

Prehrambena tehnologija i biotehnologija / Food Technology and Biotechnology

- Parađiković, N. (2009). Opće i specijalno povrćarstvo, Poljoprivredni fakultet u Osijeku, Osijek, HR: Tipo, pp. 189-193.
- Parađiković, N., Vinković, T., Štolfa, I., Tkalec, M., Has-Schön, E., Andračić, I., Parađiković, L., Kraljićak, J. (2012): Antioksidacijska aktivnost Ozimoga slavnskoga češnjaka (*Allium sativum* L.), *Poljoprivreda*, 18 (2), 44-49.
- Rainy, G., Amita, S. Preeti, M., Shukla, R.N. (2014): Study of Chemical Composition of Garlic Oil and Comparative Analysis of co-trimoxazole in Response to *In Vitro* Antibacterial Activity, *Int. Res. J. Phar.* 5 (2), 97-101.
- Re, R., Pellegrini, N., Proteggente, A., Pannala, A., Yang, M., Rice-Evans, C.A. (1999): Antioxidant activity applying an improved ABTS radical cation decolorization assay, *Free Radic. Biol. Med.* 26 (9-10), 1231-1237.
- SAS/STAT (2010). Version 9.3, Cary, NC, USA: SAS Institute.
- Šic Žlabur, J., Voća, S., Dobričević, N., Pliestić, S., Galić, A., Boričević, A., Borić, N. (2016): Ultrasound-assisted extraction of bioactive compounds from lemon balmand peppermint leaves, *Int. Agrophys.* 30 (1), 95-104.
- Worthington, V. (2001): Nutritional Quality of Organic Versus Conventional Fruits, Vegetables, and Grains. *J. Altern. Complement. Med.* 7 (2), 161-173.

Original research paper

Determination of correlations between electrical conductivity, dry matter, total polyphenolic content and antioxidant capacity of marigold extracts (*Calendula officinalis*)

Davor Valinger*, Tamara Jurina, Maja Benković, Ana Jurinjak Tušek,
Ana Belščak-Cvitanović, Marija Jakelić, Jasenka Gajdoš Kljusurić

*University of Zagreb, Faculty of Food Technology and Biotechnology, Pierottijeva 6, 10000
Zagreb, Croatia*

**Corresponding author: dvalinger@pbf.hr*

Summary

Marigold has been used in folk medicine for centuries. Traditionally, marigold has been used to treat conjunctivitis, blepharitis, eczema, gastritis, minor burns including sunburns, warts, and minor injuries such as sprains and wounds. Today, marigold is being investigated for its anti-cancer properties.

In this research, physical properties (dry matter content and electrical conductivity of the extracts) and chemical properties (total polyphenolic content and antioxidant capacity) of marigold extracts were correlated. The plant extracts were prepared by conventional aqueous extraction using a high solid-to-liquid ratio (50 w/w) and by stirring (500 rpm) at three different temperatures (40 °C, 60 °C, 80 °C) for 90 minutes. Simple regression models showed strong positive correlations between electrical conductivity, dry matter, total polyphenolic content and antioxidant capacity at the temperatures of 40 °C, 60 °C and 80 °C.

Keywords: electrical conductivity, dry matter, total polyphenolic content, antioxidant capacity, marigold extracts

Introduction

Botanicals and medicinal plants in their natural and processed form are widely used as remedies for the treatment of disease because they contain pharmacological and biological active ingredients (Saeidnia et al., 2005; Hajimehdipoor et al., 2014). There have been several studies documenting the antibacterial, antifungal, antiviral, anticancer and anti-inflammatory properties of plant ingredients (Harrison and Bartels, 2006; Benedek et al., 2007; Jebri, 2008).

Antioxidant compounds derived from plants play an important role as the health-protecting factors. They comprise of a wide variety of compounds, such as polyphenols, vitamins, flavonoids, terpenoids, carotenoids and phytoestrogens. Antioxidants are also widely used as additives in fats and oils in food processing to prevent or to delay spoilage of foods (Suhaj, 2006) and therefore, the

Prehrambena tehnologija i biotehnologija / Food Technology and Biotechnology

interest in the recovery of antioxidant compounds from herbal material is increasing in the food industry.

Marigold (*Calendula officinalis*) belongs to the *Asteraceae* family, numerous species of which are found all over the world (Piccaglia et al., 1998). The therapeutic properties of marigold are various. Valid antispasmodic effect is one of its characteristics for internal use, while, in the form of decoction, it is very useful for treatment of gastric ulcer. In the form of ointments, marigold has excellent antiseptic and antibacterial properties. Anticancer property is one that is most researched today, in particular for treatment of the gastric cancer. According to recent literature, there has been evidence of success in treating certain cancers (i.e. Heren's carcinoma) combining marigold with other herbs such as *Echinacea purpurea*, *Scorzonera humilis* L., and *Aconitum moldavicum* (Mahmoud, 2013). In dermatology, marigold is used as a powder which is then added to the creams for treatment of acne and skin blemishes. According to the fact that marigold contains polyphenols, assessment of its antioxidant properties is of great interest in the understanding of positive effect of these compounds, especially in phytotherapy (Ćetković et al., 2004).

Extraction is a very important stage in obtaining the highest possible amount of bioactives (Roj, 2014; Nkhili et al., 2009; Bart, 2011; Mustafa and Turner, 2011; Wong Paz et al., 2015). Previous studies have shown the influence of different extraction conditions on the extraction yields of phenolic compounds from natural sources (Stangler Herodež et al., 2003; Achouri et al., 2005; Lapornik et al., 2005; Spigno et al., 2007; Bucić-Kojić et al., 2007).

In order to optimise solid-liquid extraction conditions, experimental data are often used for mathematical modeling. Different mathematical models can be used in the design process in order to reduce energy, time and chemical reagents consumption (Jokić et al., 2010; Piwowska and González-Alvarez, 2012; Simeonov and Koleva, 2012; Paunović et al., 2014; Jurinjak Tušek et al., 2016).

In agreement with that, the aim of this work was to investigate correlations between electrical conductivity, dry matter, total polyphenolic content and antioxidant capacity of marigold extracts, prepared by conventional aqueous extraction at different temperatures (40, 60 and 80 °C). Correlations were performed using simple regression models, in order to conclude whether the number of measurements, required to analyse these extracts, can be reduced and thus reduce time and chemicals used for analysis.

Materials and Methods

Plant material

Dried plant material of marigold (*Calendula officinalis*) flower was purchased from a specialized herbal store Suban d.o.o. (Strmec Samoborski, Croatia) and stored at ambient conditions until used in further experiments. According to manufacturer specifications, plant material was dried naturally and the final dry matter content of the lot after drying was 89.17 %

Chemicals and reagents

Folin-Ciocalteu reagent and sodium carbonate were purchased from Kemika (Zagreb, Croatia). Trolox (6-hydroxy-2,5,7,8-tetramethylchromane-2-carboxylic acid) and potassium peroxodisulphate were obtained from Fluka (Buchs, Switzerland). ABTS•+ (2,2'-azino-bis(3-ethylbenzothiazoline-6-

sulphonic acid)diammonium salt), gallic acid (3,4,5-trihydroxybenzoic acid) were obtained from Aldrich (Sigma–Aldrich Chemie, Steinheim, Germany), and ethanol (96 %) was obtained from Carlo Erba Reagents (Cornaredo, Italy).

Extraction procedure

An amount of 30 g of dry plant material was placed in a 0.002 m³ glass with 0.0015 m³ of deionised water, covered with aluminium foil and heated to a specific temperature ($T = 40, 60, 80 \text{ }^{\circ}\text{C} \pm 0.5 \text{ }^{\circ}\text{C}$) using Ika HBR4 digital water bath (IKA-Werk GmbH & Co.KG, Staufen, Germany) at magnetic stirrer rotational speed of 500 rpm for 90 min. Experiment was performed with the plant material particle size range from 3000 – 4000 μm . Samples of 5 mL were taken from the initial glass at regular time intervals (0.5, 1, 2, 3, 4, 5, 6, 7, 8, 9, 10, 15, 20, 25, 30, 35, 40, 45, 50, 55, 60, 70, 80, 90 min). Samples were immediately cooled in the water-ice mixture, then filtered through a cellulose paper filter (LLG Labware, Meckenheim, Germany) with 5 – 13 μm pore size and stored at 4 $^{\circ}\text{C}$ until analysed.

Determination of total polyphenolic content (TPC), dry matter, electrical conductivity and antioxidant capacity

For the analysis of bioactive parameters, total polyphenolic content and radical scavenging capacity of previously prepared water extracts were determined. TPC was determined spectrophotometrically by the Folin-Ciocalteu reagent, according to a modified method of Lachman et al. (1998). TPC was calculated based on calibration curve determined for gallic acid (0 – 0.1 kg/m³) and the results were expressed as kg gallic acid equivalents (GAE)/m³. Electrical conductivity of water extracts was determined using SevenCompact conductometer (Mettler Toledo, Switzerland).

For the assessment of antioxidant capacity, the Trolox equivalent antioxidant capacity (TEAC) was estimated by the ABTS radical cation decolorization assay (Re et al., 1999). The results were derived from a calibration curve determined for Trolox (0.0001 – 1 mmol/m³).

Dry matter was determined by oven-drying at 105 $^{\circ}\text{C}$, according to the standard AOAC method (AOAC 1990). Approximately 3 g of extracts were dried for 4 hours at 105 $^{\circ}\text{C}$ in weighing dishes previously filled with quartz sand.

Regression analysis

Simple regression models were applied for the correlation analysis of physical and chemical properties of marigold extracts with the use of Statistica 10.0 (Stat Soft Inc., SAD) software.

Results and Discussion

The aim of this study was to investigate correlations between electrical conductivity, dry matter, TPC and TEAC of marigold extracts prepared by conventional aqueous extraction at three different temperatures (40, 60 and 80 $^{\circ}\text{C}$). Simple regression models were used for the correlation analysis of physical and chemical properties of marigold water extracts.

Correlations between electrical conductivity and TPC are presented in Fig. 1.

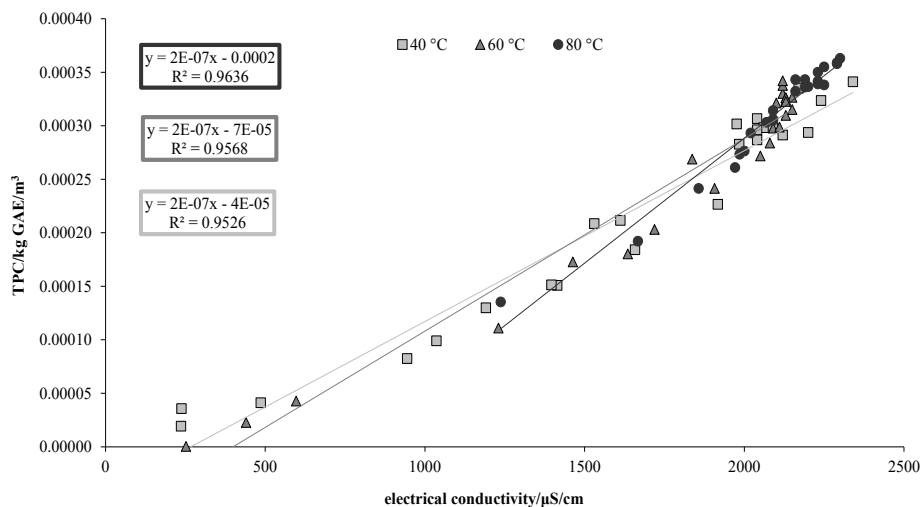

Fig. 1. Linear correlations between electrical conductivity and TPC

As seen from Fig. 1, TPC in marigold water extracts increases as the extraction temperature rises which is in accordance with the results of previous studies (Jokić et al., 2010; Jurinjak Tušek et al., 2016). Quantitatively, the highest concentration of TPC (0.00036 kg GAE/m³) was obtained at 80 °C while the lowest TPC value (0.00032 kg GAE/m³) was obtained at 40 °C. Similar results regarding the TPC concentration in marigold water extracts were obtained in the study of Četković et al. (2004) and Velicković et al. (2014), with a remark that they used different extraction solvents. Simple regression models showed excellent correlation between electrical conductivity and TPC for all tested temperatures ($R^2 > 0.95$). Since polyphenol structure includes conjugated benzene rings with high electron density and act as proton donors, polyphenol solutions exhibit electrical conductivity. In such solutions, higher polyphenolic content also means higher electrical conductivity, which was also confirmed by this study.

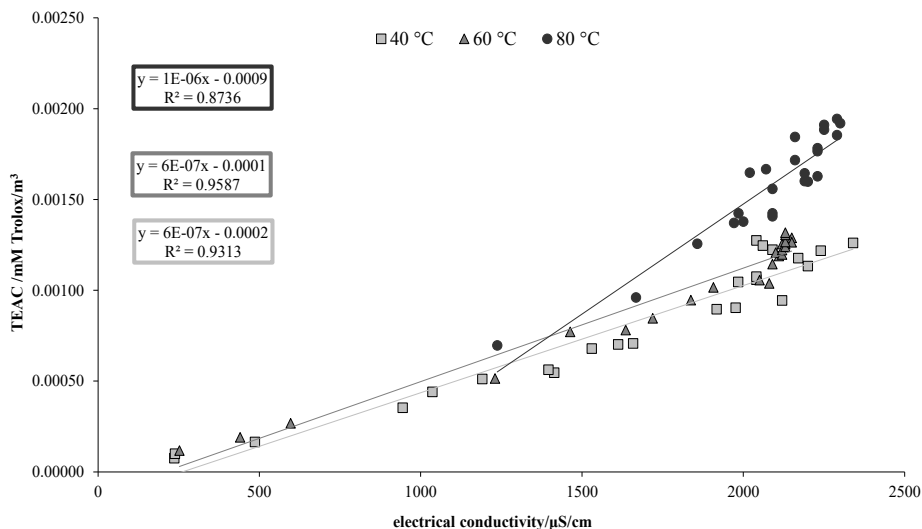

Fig. 2. Linear correlations between electrical conductivity and TEAC

TEAC was determined by the scavenging assay of ABTS radical. Correlations between electrical conductivity and TEAC are presented in Fig. 2. According to the obtained results, higher TEAC can be seen at higher values of electrical conductivity.

Similar to TPC, the highest TEAC of marigold water extracts (0.00194 mM Trolox/m³) was observed at 80 °C while the lowest TEAC (0.00126 mM Trolox/m³) was observed at 40 °C, after 90 minutes of extraction (Fig. 2). The results of ABTS radical scavenging imply that extraction at higher temperatures ensures the recovery of compounds with higher TEAC than the extraction at lower temperatures (Jurinjak Tušek et al., 2016).

Based on the comparison of the calculated correlation coefficients, it can be concluded that correlation between electrical conductivity and TEAC was strong at 80 °C ($R^2 = 0.87$) and at temperatures of 40 °C and 60 °C excellent correlations were observed ($R^2 = 0.96$ and $R^2 = 0.93$, respectively).

Extraction yield is a measure of the solvent efficiency to extract specific components from the original material (Aspé and Fernández, 2011) and it was expressed as gram of dry matter content of extract per mass of the extract. According to the results presented in Fig. 3 and Fig. 4, the lowest R^2 values were observed for the correlations between dry matter and TPC and between dry matter and TEAC for the extraction conducted at 80 °C ($R^2 = 0.83$ and $R^2 = 0.79$, respectively). As suggested by previous studies (Wijngaard et al., 2012), extractions are usually conducted at temperatures between 35 and 100 °C, depending on the compounds that are being extracted. Possible explanation of the lowest value of correlation coefficients can be due to considerable scattering between experimental data, which can be attributed to possible drawbacks of the filtration of the extracts and interference during further extract analysis. This was not the case at lower temperatures (40 °C and 60 °C) where strong correlations were obtained between dry matter and TPC ($R^2 > 0.96$ and $R^2 > 0.98$, respectively), as well as for TEAC ($R^2 > 0.96$ and $R^2 > 0.99$, respectively) (Figs. 3 and 4).

Prehrambena tehnologija i biotehnologija / Food Technology and Biotechnology

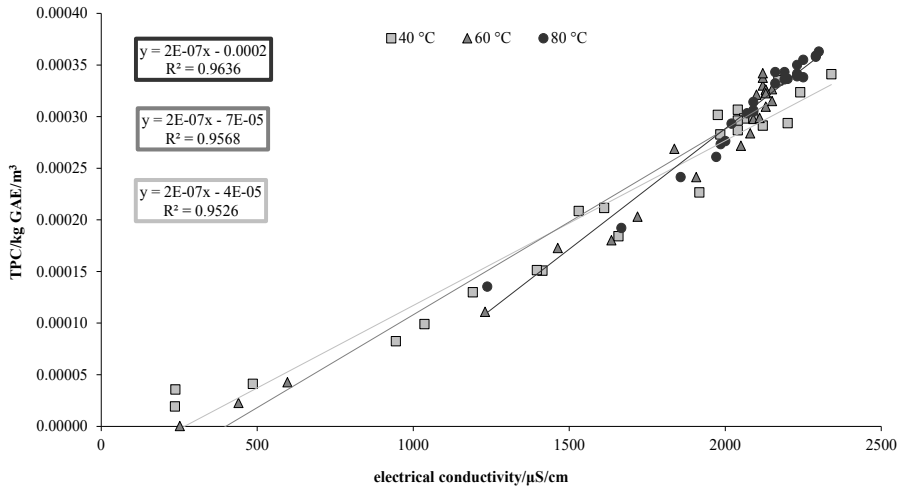

Fig. 3. Linear correlations between electrical conductivity and TPC

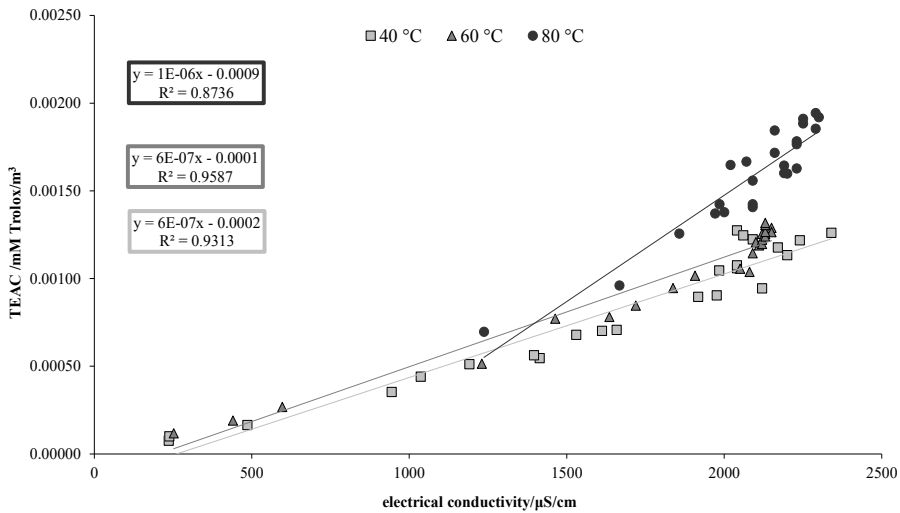

Fig. 4. Linear correlations between electrical conductivity and TEAC

Conclusions

There is ever growing demand for extraction of bioactive compounds from plant materials. The main problem is that solvents used in most of the fast extractions are not environmentally friendly. In order to standardise most frequently used aqueous extraction method, standardisation of sample preparation and extraction is necessary to allow comparison between physical and chemical properties of investigated medicinal plants. Results presented in this work can help reduce the number of measurements required to analyse marigold aqueous extracts. For example, TPC for known dry matter content of a given plant can be calculated from the regression curve and thus reduce time and chemicals used in analysis.

Acknowledgment: This study is a contribution to the project „Application of microreactors in the analysis of antioxidant activity of medicinal plants (MICRO-AA)“, project number HR.3.2.01-0069, which is funded by the European Social Fund (ESF) through the Human Resources Development program.

References

- Achouri, A., Boye, J.I., Belanger, D. (2005): Soybean isoflavones: Efficacy of extraction conditions and effect of food type on extractability, *Food Res. Int.* 38, 1199-1204.
- AOAC International (1990) Official Methods of Analysis, 15th edition, Association of Official Analytical Chemists, Arlington.
- Aspé, E., Fernández, K. (2011): The effect of different extraction techniques on extraction yield, total phenolic, and anti-radical capacity of extracts from *Pinus radiata* Bark, *Ind. Crops Prod.* 34, 838-844.
- Bart, H.-J. (2011): Extraction of Natural Products from Plants – An Introduction, In: Industrial Scale Natural Products Extraction, Bart, H.-J., Pilz S. (eds), Weinheim, Germany: Wiley-VCH Verlag GmbH & Co. KGaA, pp. 1-25.
- Benedek, B., Kopp, B., Melzig, M.F. (2007) *Achillea millefolium* L.s.l. – is the anti-inflammatory activity mediated by protease inhibition?, *J. Ethnopharmacol.* 113 (2), 312-317.
- Bucić-Kojić, A., Planinić, M., Tomas, S., Bilić, M., Velić, D. (2007): Study of solid-liquid extraction kinetics of total polyphenols from grape seeds, *J. Food Eng.* 81, 236-242.
- Ćetković, G.S., Djilas, S.M., Čanadanović-Brunet, J.M., Tumbas, V.T. (2004): Antioxidant properties of marigold extracts, *Food Res. Int.* 37 (7), 643-650.
- Hajimehdipoor, H., Gohari, A. R., Ajani, Y., Saeidnia, S. (2014): Comparative study of the total phenol content and antioxidant activity of some medicinal herbal extracts, *Res. J. Pharmacogn. (RJP)* 1 (3), 21-25.
- Harrison, A. P., Bartels, E. M. (2006): A modern appraisal of ancient Etruscan herbal practices, *Am. J. Pharmacol. Toxicol.* 1 (2), 21-24.
- Mahmoud, G. I. (2013): Biological effects, antioxidant and anticancer activities of marigold and basil essential oils, *J. Med. Plants Res.* 7, 561-572.
- Nkhili, E., Tomao, V., El Hajji, H., El Boustani, E.-S., Chemat, F., Dangles, O. (2009): Microwave-assisted water extraction of green tea polyphenols, *Phytochem. Anal.* 20, 408-415.

Prehrambena tehnologija i biotehnologija / Food Technology and Biotechnology

- Jebril, A.O. (2008) A screening study on the antimicrobial and hepatoprotective effects of some medicinal plants in Libya. MSc. Thesis. Faculty of Science, Al-Fateh University, Tripoli.
- Jokić, S., Velić, D., Bilić, M., Bucić-Kojić, A., Planinić, M., Tomas, S. (2010): Modelling of the process of solid-liquid extraction of total polyphenols from soybeans, *Czech J. Food Sci.* 28, 206-212.
- Jurinjak Tušek, A., Benković, M., Belščak-Cvitanović, A., Valinger, D., Jurina, T., Gajdoš Kljusurić, J. (2016): Kinetics and thermodynamics of the solid-liquid extraction process of total polyphenols, antioxidants and extraction yield from *Asteraceae* plants, *Ind. Crops Prod.* 91, 205-214.
- Lachman, J., Hosnedl, V., Pivec, V., Orsák, M. (1998): Polyphenols in cereals and their positive and negative role in human and animal nutrition. In: Proceedings of Conference Cereals for Human Health and Preventive Nutrition, Agricultural Research Institute Kroměříž: Brno, Czech Republic, pp. 118-125.
- Lapornik, B., Prošek, M., Golc Wondra, A. (2005): Comparison of extracts prepared from plant by-products using different solvent and extraction time, *J. Food Eng.* 71, 214-222.
- Mustafa, A., Turner, C. (2011): Pressurized liquid extraction as a green approach in food and herbal plants extraction: A review, *Anal. Chim. Acta.* 703(1), 8-18.
- Paunović, D.Đ., Mitić, S.S., Kostić, D.A., Mitić, M.N., Stojanović, B.T., Pavlović, J.L.J. (2014): Kinetics and thermodynamics of the solid-liquid extraction process of total polyphenols from barley, *Adv. Technol.* 3 (2), 58-63.
- Piccaglia, R., Marotti, M., Grandi, S. (1998): Lutein and lutein ester content in different types of *Tagetes patula* and *T. erecta*, *Ind. Crops Prod.* 8 (1), 45-51.
- Piowarska, N., González-Alvarez, J. (2012): Extraction of antioxidants from forestry biomass: kinetics and optimization of extraction conditions, *Biomass Bioenergy.* 43, 42-51.
- Re, R., Pellegrini, N., Proteggente, A., Pannala, A., Yang, M., Rice-Evans, C. (1999): Antioxidant activity applying an improved ABTS radical cation decolorization assay, *Free Radic. Biol. Med.* 26 (9-10), 1231-1237.
- Roj, E. (2014): Supercritical CO₂ extraction and its application. Polish Foundation of the Opportunities Industrialization Centers "OIC Poland", Lublin.
- Saeidnia, S., Yassa, N., Gohari, A.R., Shafiee, A., (2005): Isolation and identification of flavonoid constituents from of *Achillea conferta* DC, *J. Med. Plants* 4 (14), 12-20.
- Simeonov, E., Koleva, V. (2012): Solid-liquid extraction of tannins from *Geranium Sanguineum* L. – experimental kinetics and modelling, *Chem. Biochem. Eng. Quart.* 26 (3), 249-255.
- Spigno, G., Tramelli, L., De Faveri, D.M. (2007): Effects of extraction time, temperature and solvent on concentration and antioxidant activity of grape marc phenolics, *J. Food Eng.* 81, 200-208.
- Stangler Herodež, Š., Hadolin, M., Škerget, M., Knez, Ž. (2003): Solvent extraction study of antioxidants from balm (*Melissa officinalis* L.) leaves, *Food Chem.* 80, 275-282.
- Suhaj, J. (2006): Spice antioxidants isolation and their antiradical activity: a review, *J. Food Compos. Anal.* 19, 531-537.
- Velicković, J.M., Dimitrijević, D.S., Mitić, S.S., Mitić, M.N., Kostić, D. A. (2014): The determination of the phenolic composition, antioxidative activity and heavy metals in the extracts of *Calendula officinalis* L., *Adv. Technol.* 3 (2), 46-51.

- Wijngaard, H., Hossain, M.B., Rai, D.K., Brunton, N. (2012): Techniques to extract bioactive compounds from food by-products of plant origin, *Food Res. Int.* 46 (2), 505-513.
- Wong Paz, J.E., Muñiz Márquez, D.B., Martínez Ávila, G.C.G., Belmares Cerda, R.E., Aguilar, C.N. (2015): Ultrasound-assisted extraction of polyphenols from native plants in the Mexican desert, *Ultrason. Sonochem.* 22, 474-481.

Original research paper

Application of artificial neural networks (ANNs) for development of HPLC gradient separation methods of polyphenolic compounds in medicinal plants

Ana Belščak-Cvitanović*, Ana Jurinjak Tušek, Davor Valinger, Maja Benković, Tamara Jurina, Draženka Komes

University of Zagreb, Faculty of Food Technology and Biotechnology, Pierottijeva 6, 10000 Zagreb, Croatia

**Corresponding author: abelscak@pbf.hr*

Summary

Extensive research activities have been undertaken recently to systematize the identification, standardization and use of medicinal plants. For that purpose, high performance liquid chromatography (HPLC) methods are imperative for the regular quality control and identification of pharmacologically active compounds. Enormous research efforts have been conducted so far resulting in a vast number of HPLC methods developed for identifying polyphenolic constituents of medicinal plants. In the present study, the approach of using artificial neural networks (ANNs) for prediction of optimal HPLC method for the separation of different groups of polyphenolics was applied. For that purpose, the composition of the mobile phase, pH, analysis duration and flow rate as the input parameters were investigated on separation behaviour of gallic, rosmarinic and chlorogenic acids as well as quercetin and rutin as the outputs from five different medicinal plant extracts. The optimal neural network chosen based on the values of the root mean square error (RMSE) and the linear correlation coefficient (R^2) was able to accurately predict the experimental responses. The results of the present study confirm the usefulness of ANNs in the development of HPLC gradient separation methods.

Keywords: artificial neural networks (ANNs), HPLC, medicinal plants, polyphenols

Introduction

The extensive research and use of medicinal plants attributed to their therapeutic properties has led to development of semi-industrial or industrial processes enabling their transformation into safe, reliable and stable phytopharmaceutical products. Moreover, effective quality control and standardization of active ingredients from diverse medicinal plants are becoming an imperative, with continuously increasing number of analytical techniques being developed and employed for that purpose.

High-performance liquid chromatography (HPLC) nowadays is one of the most often employed analytical techniques used for identification and quantification of bioactive phytomarkers of medicinal plants and their preparations. Most of the developed analytical HPLC methods that are used to analyze these drugs individually or in combinations require the use of specialized columns,

gradient elution, and/or complex mobile phases, which results in cost-ineffective methods for routine analysis (Shah et al., 1991). Although research is still directed toward further improvements in columns, the improvement of separations may be achieved only by adjusting the chromatographic conditions. Chromatographic systems are quite complex, and the intentional variation of a system condition can often result in the change of elution order as a function of the system condition (Glass et al., 2007).

Usually the optimization of a process is conducted by varying just one variable while keeping the others constant. The major disadvantage of this single variable optimization is that it does not include interactive effects among the variables (Ortega et al., 2003). In order to overcome this major problem, process optimization studies have been done using experimental design (Capella-Peiró et al., 2006; Žunić and Spasić 2008; Liu et al., 2011). New approaches towards optimization are using combination of experimental design and artificial neural network (ANN) (Zhang et al., 2005; Liu et al., 2009). Modelling of response surfaces based on experimental design and ANN has been demonstrated as an adequate tool to improve the analytical results in diverse analytical techniques, such as capillary electrophoresis (Havel et al., 1999) or HPLC (Glass et al., 2007).

In case of HPLC gradient separation methods, method optimization is commonly conducted by varying only one or two chromatographic conditions, most often pH and solvent composition (percentage) (Glass et al., 2007) or the flow rate (Bogdanovska et al., 2013; Maher, 2014). Moreover, HPLC separation methods are mostly developed and optimized for the quantification of a single pharmaceutically active drug or compound, or a mixture of several compounds, while appropriate optimization studies for separation and quantification of natural bioactive phytochemicals are lacking.

In the present study an attempt was made to develop a HPLC method for separation and detection of polyphenolic compounds from medicinal plants and herbs. Although a vast number of HPLC methods have been reported for the separation and identification of polyphenolic compounds, usually those methods are developed for the purpose of analyzing a single substrate and a limited number of analytes. Therefore, a need arises for a universal method which would allow the separation and quantification of a large number of polyphenolic compounds from different substrates, such as medicinal plants and herbs. By varying the employed chromatographic conditions in the present study, a new, universal HPLC method for efficient separation of a range of polyphenolic compounds from different medicinal plants was developed. For the purpose of deriving the most efficient method and chromatographic conditions ANN was used as a mathematical optimization tool.

Materials and Methods

Plant materials

Dried plant materials of yarrow (*Achillea millefolium*), nettle (*Urtica dioica*), dandelion (*Taraxacum officinale*), rosemary (*Rosmarinus officinalis*), chamomille (*Matricaria recutita*) and plantain (*Plantago lanceolata*) were purchased from a specialized herbal store (Suban d.o.o., Croatia). All plant materials were collected in the north-western part of Croatia during the flowering seasons of 2015, dried and properly stored until used. Dry matter content of plant materials was determined by oven-drying at 105 °C, according to the standard AOAC method (AOAC, 1990).

Prehrambena tehnologija i biotehnologija / Food Technology and Biotechnology

Plant extracts preparation

An amount of 2 g of the dry plant material was placed in a 200 mL glass with 50 mL of deionised water heated to 80 °C (± 0.5 °C) using an oil-bath (IKA-Werk GmbH & Co.KG, Staufen, Germany). Extraction was carried out under stirring with magnetic stirrer at 250 rpm for 60 min. After the extraction, the samples were immediately cooled in an ice bath, and filtered through filter paper and stored at 4 °C until analysed.

High performance liquid chromatography analysis

The HPLC analysis was conducted using an Agilent 1100/1200 Series HPLC device (Agilent, Santa Clara, USA) and a Photodiode Array Detector (Agilent, Santa Clara, USA) with a reversed-phase ACE C-18 column (Agilent, Santa Clara, USA) (250 x 4.6 mm, 5 μ m i.d.). Chromatographic conditions from previously developed methods (Belščak-Cvitanović et al., (2012); Wang, Provan & Helliwel, (2004); Durling et al., (2007); Wen et al., (2005)) were employed and the solvent composition (formic, *o*-phosphoric, trifluoroacetic acids; methanol, acetonitrile), pH (1.95 – 2.75), flow rate (0.5 – 1.0 mL min⁻¹), column temperature (25-30 °C) and method duration (25 – 60 min) were varied. The injection volumes in each method evaluated was $V = 10$ μ L. For the HPLC analysis, all medicinal plant samples were filtered through a 0.45 μ m filter (Nylon Membranes, Supelco, Bellefonte, USA) before injection. For quantification purposes, chromatograms were recorded and detection of the phenolic compounds was carried out at 278 nm. Prior to each run, the HPLC-DAD system was allowed to warm, and the baseline was monitored until it was stable before sample analysis. Peak identification was achieved by comparison of both the retention time and UV absorption spectrum with those obtained with standards.

Artificial neural network

Nonlinear neural multiple layer perceptron (MLP) network was applied for prediction of optimal chromatographic conditions for polyphenol HPLC gradient separation method from medicinal plants. For the design of ANN, chromatographic conditions; mobile phase composition, pH, column temperature, method duration and flow rate were used as input variables, while the concentrations and retention times of individual polyphenolics (rosmarinic and chlorogenic acids as well as quercetin and rutin) served as output variables, as depicted on Figure 1. Artificial neural network (ANN) training was performed with separation of experimental data into training, test and validation sets as 70:15:15 ratios, respectively. Back error propagation algorithm available in Statistica 10.0 (StatSoft, USA) was applied for model training. Selection of the optimal neural network architecture was performed by comparing the values of the root mean square error (RMSE) and the linear correlation coefficient (R^2).

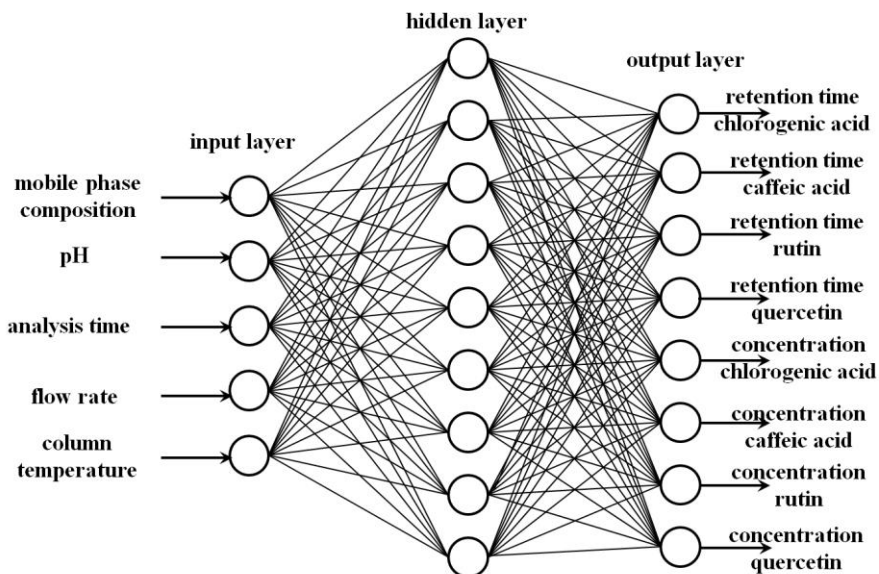

Fig. 1. Architecture of ANN selected for prediction of retention times and concentrations

Results and Discussion

For the analysis of polyphenols, reversed-phase HPLC using modified silica surfaces with C-8 or C-18 is the preferred method due to the efficient separation and symmetrical peaks obtained, which enable quantification of analytes at low concentration levels. However, the HPLC analysis of those compounds can be problematic, due to interactions of the analyte with residual silanols on the silica surface of the column and ion exchange retention mechanism. Therefore, the effect of each chromatographic condition during HPLC analysis needs to be established and the combination of the most relevant chromatographic parameters defined in order to enable an efficient method development. As a starting point for the development of a new, universal HPLC method for the analysis of a large number of polyphenolic compounds from medicinal plants and their extracts and preparations, chromatographic conditions adapted from previously conducted methods in scientific literature sources (Wellwood and Cole, 2004; Wang et al., 2004; Wen et al., 2005; Fecka and Turek, 2008; Durling et al., 2007; Belščak-Cvitanović et al., 2012) were employed in the present study. The best peak resolution and separation of diverse polyphenolic compounds from both a mixture of representative standards and several real samples (plant extracts) were selected as the chromatographic efficiency indicators.

As can be seen in Figure 2, the separation efficiency of different methods is markedly affected by the employed chromatographic conditions. Aiming at the development of a rapid and efficient HPLC method, the application of methods 3 and 4 characterized by the application of higher column temperatures (30 °C) during prolonged analysis did not provide an efficient peak separation

in a sufficiently short time. Only the separation efficiency of methods 2 and 5 provided a satisfying separation effect and quantitatively, the highest compound recovery.

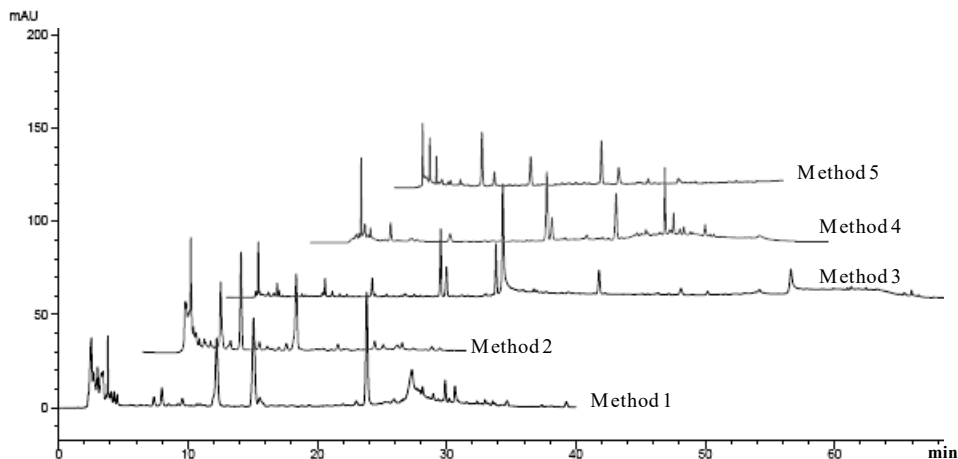

Fig. 2. Comparative chromatograms of chamomille extract obtained by the employed HPLC gradient separation methods

However, in order to define the most efficient chromatographic conditions, and develop a rapid method that will allow the identification of diverse polyphenolic compounds, the application of ANN was evaluated.

The use of artificial neural networks has gained increased importance in the recent years as they can be used as tools for food safety and quality analyses, which include modelling of microbial growth, food safety predictions, interpreting spectroscopic data, and predicting physical, chemical, functional and sensory properties of various food products during processing and distribution (Huang et al., 2007). In the present study, artificial neural network was employed to predict the influence of the chromatographic conditions on the separation and quantification of polyphenolic compounds in diverse medicinal plant extracts, with the aim of optimization and definition of a universal HPLC gradient separation method.

A total of six different medicinal plants were used in network formation, with four representative polyphenolic compounds chosen for being commute analytes in all evaluated medicinal plant extracts. Three parallel measurements of each evaluated polyphenolic compound were performed, making a total of 1170 numerical values for network formation. In order to determine the ANN configuration for prediction of the optimal chromatographic conditions during HPLC analysis, the number of neurons in the hidden layer varied from three to eleven. Different activation functions were tested (Identity, Logistic, Tanh and Exponential). Among various architectures tested, the fifteen showing the lowest RMSE and highest R^2 values are presented in Table 1.

The most suitable network for further analysis was selected based on training, test and validation preferences and errors, as previously stated by Carvalho et al. (2013) and Di Scala et al. (2013). Network bolded in Table 1 (Network number 4), consisting of a hidden activation function Logistic

and Tanh output function, with the maximum validation error of 0.086, was selected for analysis of the chromatographic conditions and separation.

Table 1. Characteristics of selected neural networks

Network	Training perf./ Training error	Test perf./ Test error	Validation perf./ Validation error	Hidden activation	Output activation
1	0.713 0.078	0.585 0.116	0.707 0.088	Tanh	Logistic
2	0.715 0.077	0.579 0.115	0.721 0.085	Identity	Logistic
3	0.711 0.080	0.587 0.155	0.716 0.089	Identity	Tanh
4	0.715 0.078	0.574 0.116	0.729 0.086	Logistic	Tanh
5	0.714 0.078	0.574 0.115	0.728 0.087	Tanh	Tanh

The selected neural network comprised of 5 input variables, representing the used chromatographic conditions. Hidden layer contained 9 neurons and the output layer contained 8 different variables – related to the determined concentrations and retention times of evaluated polyphenolic standards. Comparison between experimentally obtained data and ANN predicted values of the output characteristics are presented in Figures 3a-d.

By comparing the representative graphic depictions of experimentally determined and ANN predicted values of both phenolic acids (chlorogenic and caffeic), it can be noticed that almost an uniform distribution of retention times (Fig 3a and b) around the proposed model was achieved, as opposed to a much wider data dispersion in case of polyphenolic compounds concentrations (Fig 3c and d). The obtained R^2 values for comparison of experimental and ANN predicted values of retention times for chlorogenic and caffeic acids were 0.996 and 0.997, respectively, which indicated a good agreement between experimental data and the proposed model. Conversely, very low R^2 values were obtained for comparison of experimental and ANN predicted values of chlorogenic and caffeic acids concentrations (0.468 and 0.083).

Prehrambena tehnologija i biotehnologija / Food Technology and Biotechnology

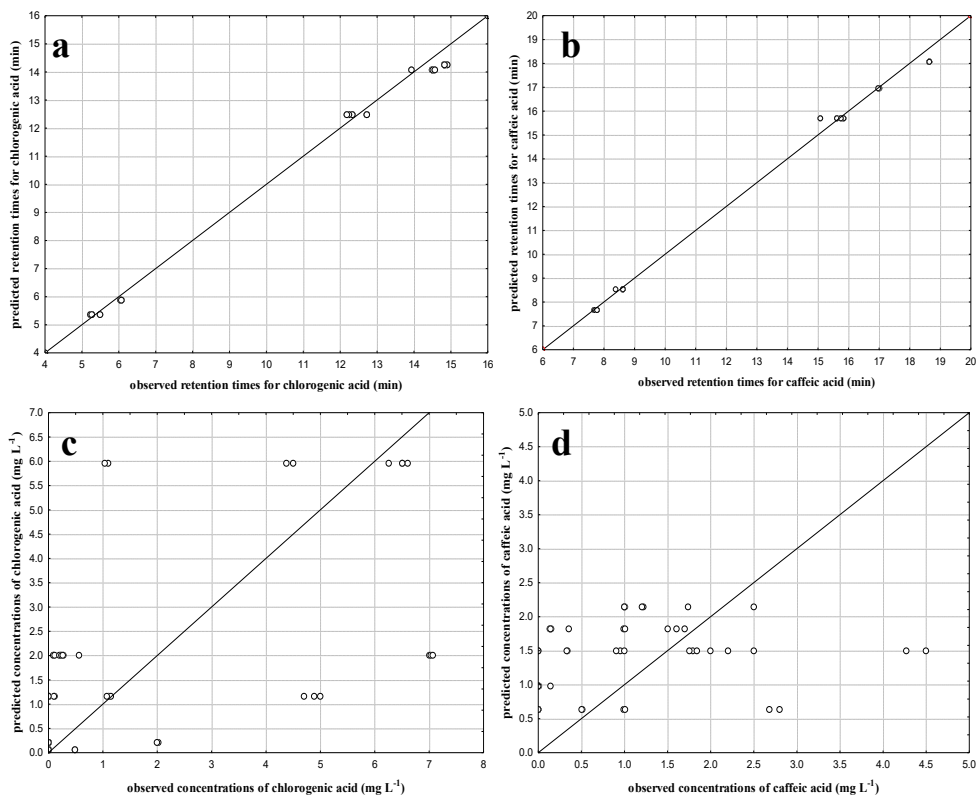

Fig. 3. Comparison between experimental and predicted values of retention times (a, b) and determined concentrations (c, d) of chlorogenic (a, c) and caffeic acids (b, d)

This may be attributed to a lower data number for determined concentrations, since in several plant extracts those compounds were not identified and resulted in greater data dispersion. Global sensitivity analysis (Figure 4) was used to establish the effect of varying inputs on the output and to rank inputs in order of importance. Even though neural networks cannot produce explicit rules, sensitivity analysis enables to explain which inputs are more important than others. It can give important insights into the usefulness of individual variables and rate variables according to the deterioration in modelling performance that occurs if that variable is no longer available to the model (Maher et al., 2013).

Global sensitivity coefficient, as an indicator of influence of the particular input parameter on the output variable, is defined as the ratio of variances of individual parameter relative to the total variance. Higher global sensitivity coefficient corresponds to higher influence on the output variables. As shown in Figure 4, the flow rate of mobile phase employed during the chromatographic analyses had the highest influence on retention times and resulting polyphenolics concentrations. Usually, in RP-HPLC, the retention of analytes is greatly dependent on their

ionization and solvation states, which are influenced by the pH, ionic strength of the buffer and the eluent composition (Roses et al., 1996). These observations were confirmed in the present study since the global sensitivity analysis justified their equal importance on the output variables.

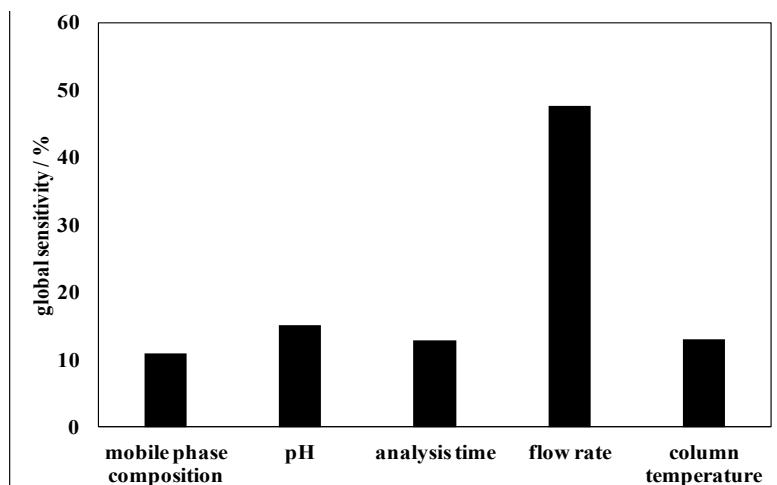

Fig. 4. Global sensitivity analysis results

However, the results indicated that marked variations in the flow rate of mobile phases during HPLC analysis had a very pronounced effect on the resulting retention times and analyte concentrations. As a result, the proposed ANN model was used to find the optimal analysis conditions of polyphenolic compounds from medicinal plant extracts. The final method comprised of mobile phases consisting of 0.1 % *o*-phosphoric acid in water (solvent A) adjusted to pH 2.5 and 0.1 % *o*-phosphoric acid in methanol (solvent B), during 30 min of analysis at a flow rate of 1 mL min⁻¹ for final analysis. The developed HPLC method allowed the separation of 24 major polyphenolic compounds. Optimization of the simultaneous chromatographic method enabled an efficient separation of 3 hydroxybenzoic acids, 11 hydroxycinnamic acids and 10 free or glycosylated flavonoids from the standard mixture.

Application of the developed method provided an insight in the contents of four representative polyphenolic compounds from phenolic acids and flavonoids sub-groups. As can be seen in Table 2, each selected medicinal plant extract was characterized by a specific polyphenolic profile, establishing rosemary as a very abundant source of rutin and quercetin, and chamomile and yarrow of phenolic acids. These findings are relevant during pharmacological screening of medicinal plants and their exploitation as a source of potent biologically active phytochemicals.

Prehrambena tehnologija i biotehnologija / Food Technology and Biotechnology

Table 2. HPLC profile of phenolic acids and flavonoids (mg L⁻¹) in selected medicinal plant extracts

	<i>Chlorogenic acid</i>	<i>Caffeic acid</i>	<i>Rutin</i>	<i>Quercetin</i>
<i>Rosemary</i>	10.02	8.56	69.85	196.82
<i>Dandelion</i>	26.50	10.31	n.d.	87.19
<i>Chamomille</i>	161.40	n.d.	n.d.	n.d.
<i>Yarrow</i>	148.64	12.81	n.d.	n.d.
<i>Nettle</i>	8.26	n.d.	n.d.	n.d.
<i>Plantain</i>	n.d.	n.d.	n.d.	n.d.

n.d. = not detected

Results are expressed as mean values. Standard deviations of all measurements amounted to <10 %.

Conclusions

High degree of correlation between experimental and predicted values along with low errors indicates that ANN can be used as a very promising tool for retention modelling in HPLC. The proposed ANN models provide an insight into the relevance of employed chromatographic conditions during HPLC method development, while simultaneously taking into account the pre-determined output variables. Using the ANN as a mean of method optimization, a method was developed that allowed the separation of a large number of diverse polyphenolic compounds from botanically non-related substrates, thus signifying the wide appropriateness and expanding the use of the developed method.

Acknowledgements: This study is a contribution to the project „Application of microreactors in the analysis of antioxidant activity of medicinal plants (MICRO-AA)“, project number HR.3.2.01-0069, which is funded by the European Social Fund (ESF) through the Human Resources Development program.

References

- Belščak-Cvitanović, A., Komes, D., Benković, M., Karlović, S., Hečimović, I., Ježek, D., Bauman, I. (2012): Innovative formulations of chocolates enriched with plant polyphenols from *Rubus idaeus* L. leaves and characterization of their physical, bioactive and sensory properties, *Food Res. Int.* 48(2), 820 – 830.
- Bogdanovska, Lj., Popovska, M., Dimitrovska, A., Petkovska, R. (2013): Development and validation of RP HPLC method for determination of betamethasone dipropionate in gingival crevicular fluid, *Acta Pharm.* 63, 419–426.

- Capella-Peiró, M.E., Bossi, A., Esteve-Romero, J. (2006): Optimization by factorial design of a capillary zone electrophoresis method for the simultaneous separation of antihistamines, *Anal. Biochem.* 352, 41-49.
- Carvalho, N.B., Minim, V.P.R., Silva, R., Della Lucia, S.M., Minim, L.A. (2013): Artificial neural networks (ANN): prediction of sensory measurements from instrumental data, *Food Sci. Technol. Campinas*, 33(4), 722-729.
- Di Scala, K., Meschino, G., Vega-Galvez, A., Lemus-Mondaca, R., Roura, S., Mascheroni, R. (2013): An artificial neural network model for prediction of quality characteristics of apples during convective dehydration. *Food Sci. Technol. Campinas*, 33(3), 411 – 416.
- Durling, N.E., Catchpole, O.J., Grey, J.B., Webby, R.F., Mitchell, K.A., Foo, L.Y., Perry, N.B. (2007): Extraction of phenolics and essential oil from dried sage (*Salvia officinalis*) using ethanol–water mixtures, *Food Chem.* 101(4), 1417-1424.
- Fecka, I., Turek, S. (2008): Determination of polyphenolic compounds in commercial herbal drugs and spices from *Lamiaceae*: thyme, wild thyme and sweet marjoram by chromatographic techniques, *Food Chem.* 108(3), 1039-1053.
- Glass, B.D., Agatonovic-Kustrin, S., Chen, Y.-J., Wisch, M.H. (2007): Optimization of a Stability-Indicating HPLC Method for the Simultaneous Determination of Rifampicin, Isoniazid, and Pyrazinamide in a Fixed-Dose Combination using Artificial Neural Networks, *J. Chrom. Sci.* 45, 38-44.
- Huang, Y., Kangas, L.J., Rasco, B.A. (2007): Applications of Artificial Neural Networks (ANNs) in Food Science, *Crit. Rev. Food Sci. Nutr.* 47, 113 – 126.
- Liu, H.T., Wen, Y.Y., Luan, F., Gao, Y. (2009): Application of experimental design and radial basis function neural network to the separation and determination of active components in traditional Chinese medicines by capillary electrophoresis, *Anal. Chim. Acta.* 638, 88-93.
- Liu, M.X., Zheng, Y., Ji, Y.B., Zhang, C. (2011): Development and validation of a capillary electrophoresis method for the enantiomeric purity determination of RS86017 using experimental design, *J. Pharm. Biomed. Anal.* 55, 93-100.
- Maher, H.M. (2013): Development and validation of a stability indicating HPLC-DAD method with ANN optimization for the determination of diflunisal and naproxen in pharmaceutical tablets, *J. Liq. Chromatogr. Relat. Technol.* 37(5), 634-652.
- Ortega, N., Albillos, S.M., Busto, M.D. (2003): Application of factorial design and response surface methodology to the analysis of bovine caseins by capillary zone electrophoresis, *Food Contr.* 14, 307-315.
- Roses, M., Canals, I., Allemann, H., Siigur, K., Bosch, E. (1996): Retention of Ionizable Compounds on HPLC. 2. Effect of pH, Ionic Strength, and Mobile Phase Composition on the Retention of Weak Acids, *Anal. Chem.* 68, 4094-4100.
- Shah, V.P., Midha, K.K., Dighe, S., Mcgilveray, I.J., Skelly, J.P., Yacobi, A., Layloff, T., Viswanathan, C.T., Cook, C.E., McDowall, R.D., Pittman, K.A., Spector S. (1991): Analytical methods validation: bioavailability, bioequivalence and pharmacokinetics studies, *Europ. J. Drug. Metab. Pharmacokinet.* 16(4), 249–255.
- Wang, H., Provan, G.J., Helliwell, K. (2004): Determination of rosmarinic acid and caffeic acid in aromatic herbs by HPLC, *Food Chem.* 87(2), 307-311.

Prehrambena tehnologija i biotehnologija / Food Technology and Biotechnology

- Wellwood, C.R.L., Cole, R.A. (2004): Relevance of carnosic acid concentrations to the selection of rosemary *Rosmarinus officinalis* (L.), accessions for optimization of antioxidant yield, *J. Agric. Food Chem.* 52(20), 6101 – 6107.
- Wen, D., Li, C., Di, H., Liao, Y., Liu, H. (2005): A Universal HPLC Method for the Determination of Phenolic Acids in Compound Herbal Medicines, *J. Agric. Food Chem.* 53(17), 6624 – 6629.
- Zhang, Y.X., Li, H., Havel, J. (2005): Modeling of the relationship between electroosmotic flow and separation parameters in capillary zone electrophoresis using artificial neural networks and experimental design, *Talanta*, 65, 853-860.
- Žunić, G., Spasić, S. (2008): Capillary electrophoresis method optimized with a factorial design for the determination of glutathione and amino acid status using human capillary blood, *J. Chromatogr. B*, 873, 70-76.

Original research paper

The correlation of mineral elements shares in the soil and black locust honey within five Croatian regions and seasons

Natalija Uršulin-Trstenjak^{1*}, Davor Levanić¹, Josip Halamić², Ajka Šorša²,
Želimira Cvetković³, Jasenka Šabarić³, Danijel Brkić³

¹University North, University Centre Varaždin, 104. brigade 3, 42000 Varaždin, Croatia

²Croatian Geological Survey, Sachsova 2, 10000 Zagreb, Croatia

³Dr. Andrija Štampar Institute of Public Health, Mirogojska 16, 10000 Zagreb, Croatia

*Corresponding author: natalija.ursulin-trstenjak@unin.hr

Summary

This study included 200 samples of black locust honey collected from beekeepers through two seasons (season 1 and season 2) in five Croatian regions (20 samples from each region) (Varaždin, Krapina-Zagorje, Bjelovar-Bilogora, Eastern Croatia and Istria) and 100 soil samples from apiary areas where honey samples are taken from. Melissopalynological analysis confirmed the botanical origin of all the samples, as declared by the manufacturer – black locust honey. The dominant mineral of the 12 tested (Ca, Na, K, Mg, Zn, Fe, Cu, Mn, Al, Ni, Pb and Cd) is K 205.571-428.050 mg/kg, followed by Ca 33.526-329.327 mg/kg and Na 23.343-218.042 mg/kg. Obtained shares of the (12) minerals in soil samples are comparable with the values obtained by the Geological Survey, except for the share of Fe in the Istria region (greater than 100 times). Conducted regression analysis enabled determining the correlation of mineral share in the soil and honey regarding Na and K, and is described in the best way by linear function and characterised by high correlation coefficients.

Keywords: black locust honey, mineral profile, soil, regression analysis

Introduction

Black locust honey it is one of the most valuable types of honey in the European market with properties valued by consumers: it is liquid (due to the high level of fructose), not prone to crystallization, of very bright colour, with the scent of flowers or fresh fruit, less noticeable and of light taste (from medium to strong sweetness, low acidity and flavour without bitterness). In Croatia, the largest production is related to the production of black locust honey with the most generous pastures in the continental parts (Šarić et al., 2012).

Macro and micro elements (expressed as a percentage of ash) can be found in nectar honey in the amount of around 0.2 % and in honeydew honey of over 1 %. Darker types of honey are generally richer in mineral substances (Muñoz and Palmero, 2005). Since the typical composition of the soil of a particular region is reflected in the mineral composition of honey plant, in its nectar and honey produced, the share and composition of minerals are often used in determining the geographical and/or botanical origin of honey (Uršulin-Trstenjak et al., 2013). Many studies confirm the

Prehrambena tehnologija i biotehnologija / Food Technology and Biotechnology

correlation between the mineral content and botanical and geographical origin (Gonzales Paramas et al., 2000; Fernandes Torres et al., 2005; Nozal Nalda et al., 2005; Hernandez et al., 2005; Lachman et al., 2007; Tuzen et al., 2007).

Here we must mention the issue of trace elements that may be present in honey from natural sources (from soil Fe and Mn and plants) and from anthropogenic sources. In honey, K prevails from $\frac{1}{4}$ to $\frac{1}{2}$ share of the ash. The high share of K in the total amount of mineral substances has been noted in the samples of monofloral black locust (88 % and 97 %) and common heather *Calluna vulgaris* honey (91 %), as well as in multifloral honey from Morocco and Italy (71 %, 76 %) (Marghitas et al., 2010; Golob et al., 2005; Conti, 2000; Belouali et al., 2008; Conti et al., 2007) while Croatian honeydew honey and meadow honey contain a lower percentage of K (22 %, 28.13 %) in the total amount of mineral substances (Barišić et al., 1999). Mineral Ca compared to K in general is less frequent as it is in the black locust and thyme honey (88 % of K : 1.43 % of Ca; 97 % : 2.34 % and 48% : 13 %) (Terrab et al. 2004; Golob et al., 2005; Marghitas et al., 2010) and in different types of Italian honey (84 % of K : 9 % of Ca), but there are data that show almost equal representation of K and Ca in the clover honey (43 % of K : 41 % of Ca) in the total amount of mineral substances (Pisani et al., 2008).

Regarding other minerals, the present ones are Na (multifloral honey 15 %, black locust 6.12 %, common heather-*Calluna vulgaris* 3.9 %, honeydew 1.8 %) and Mg (common heather-*Calluna vulgaris* 3 %, black locust 2.7 %, honeydew 2.6 %) (Conti, 2000.; Marghitas et al., 2010; Fernandes-Torres et al., 2005; Nozal Nalda et al., 2005; Üren et al., 1998). There are exceptions such as in clover from Italy where Na dominates with 61.66 % (Pisani et al., 2008). S, Cl, Fe and Al are present in honey. Increased amounts of Al (22 mg/kg), which can be found in the mixture of Chilean honey, are considered to be the consequence of volcanic origin of soil, unlike Czech mixed honey containing 2.90 mg/kg of Al (Fredes and Montenegro, 2006; Lachman et al., 2007). Cu, Mn, Cr, Zn, Pb, Cd, As, Ti, Se and others are present in small quantities (Hernandez et al., 2005). The heavy metal content in honey depends on the geographical origin of honey, as evidenced by the mean values of Zn, Fe and Cu, which vary by several times compared to the samples of Swiss black locust honey (0.22; 0.28; 0.18 mg/kg), Romanian (1.8; 1.30; 0.52 mg/kg) and Italian black locust honey (1.78; 2.09; 0.576 mg/kg) (Bogdanov et al., 2007; Marghitas et al., 2010; Forte et al., 2001; Caroli et al., 2000). The increase of Fe, Zn, Ni may happen as a result of contamination caused by the contact between honey and unprotected metal surface during processing (Merin et al., 1998).

On the basis of geochemical maps, i.e. geochemical atlas of the Republic of Croatia, the concentration of individual chemical elements can be noticed in the surface soil horizons of the Croatian territory (56,538 km²). Table 1 shows the minimum (min) and maximum (max) value of macro and micro elements (which were included in this study) in the surface soil horizons according to the Geological Survey's research of the regions surveyed (Halamić and Miko, 2009).

Table 1. Minimum and maximum values of macro and micro elements in the soil by regions (Halamić and Miko, 2009).

minerals	Varaždin region	Krapina-Zagorje region	Bjelovar-Bilogora region	Eastern Croatia region	Istria region
	min - max	min - max	min - max	min - max	min - max
Ca (%)	0.13 – 14.7	0.07 – 10.39	0.19 – 4.52	0.08 – 12.17	0.2 – 18.43
Na (%)	0.16 – 1.48	0.11 – 3.21	0.51 – 1.88	0.23 – 1.94	0.232 – 1.516
K (%)	0.33 – 2.24	0.57 – 2.58	1.15 – 2.26	0.8 – 3.42	0.83 – 2.12
Mg (%)	0.32 – 7.52	0.24 – 5.33	0.25 – 1.36	0.32 – 5.84	0.25 – 1.08
Zn (mg/kg)	28 – 1.432	50 - 77	39 - 129	36 – 527	45 - 180
Fe (%)	0.6 – 4.97	1.46 – 4.87	1.74 – 6.1	1.47 – 5.61	1.82 – 7.25
Cu (mg/kg)	5 – 108	5 – 87	4 – 58	4 – 239.1	10 - 74
Mn (mg/kg)	153 – 5.619	131 – 1.695	172 – 1.278	174 – 1.618	438 – 2.478
Al (%)	1.46 – 9.26	3.05 – 9.28	4.6 – 11.81	3.42 – 10.93	3.86 – 11.71
Ni (mg/kg)	15 – 195	13 – 92	12 – 72	9.2 – 215	32 - 207
Pb (mg/kg)	19 – 699	15 – 99	14 – 47	15.6 – 202.2	12 - 71
Cd (mg/kg)	*0.2 – 7.1	*0.2 – 3.5	*0.2 – 0.8	*0.2 – 11	*0.2 – 3.2

* The values that are lower than half of the lower limit of detection were used for statistical analysis in accordance with the instructions given by FOREGS - EuroGeoSurveys Geochemical Baseline Mapping.

Materials and Methods

This study included 200 samples of black locust honey collected from beekeepers during two seasons (season 1 and season 2) in five Croatian regions with 20 samples from each region: VŽ (Varaždin), KZ (Krapina-Zagorje), BB (Bjelovar-Bilogora), IH (Eastern Croatia) and I (Istria). One hundred soil samples were sampled from the same area (according to the GPS points of apiary locations) where the apiaries from which honey samples were taken from are (Fig. 1).

Soil sampling

One sample was taken from a previously specified point (Gauss–Krüger coordinate system). The samples are sampled from the soil at the depth of 0.5 meters and are stored in PVC containers in the field. In the laboratory, prior to planting, the samples are dried at room temperature and homogenized in an agate mill and sieved to a fraction of 2 mm.

Determining mineral substances in soil

Sample preparation is carried out by extracting a mixture of concentrated acids in Teflon containers with 10 mL of a solution containing a mixture of concentrated acids (HF-HCl-HNO₃-HClO₄). The solution evaporates until dry at 200 °C. After that, the residue is dissolved with 4 mL of 50% HCl, and the heating of the sample is carried out in a microwave oven. After cooling, the solution is transferred to a polypropylene measuring bottles which are filled with 5 % HCl to the final volume of 10 mL.

Statistical data analysis

Mean value, standard deviation and coefficient of variation for the chosen macro and micro elements in the samples of black locust honey and soil have been calculated.

Statistical data analysis included regression analysis. For this purpose software package STATISTICA 9.1 (StatSoft, 2010) was used.

Results and Discussion

The obtained results show a profile of macro and micro elements of Croatian black locust honey from five regions during two seasons (season 1 and season 2) and quantitative and qualitative correlation of certain macro and micro elements in the soil and honey during both seasons and regions.

This was preceded by melissopalynological analysis as the evidence of the botanical origin of all 200 samples of honey. Conducting pollen analysis in the samples of black locust honey from both seasons of all five regions confirmed the botanical origin (greater than 21 % of family *Robinia*), as declared by the manufacturer – black locust honey (MPRRR, 2009). The most represented are those of the family of *Robinia* (black locust family), *Rosaceae* (rose family), *Brassicaceae* (cabbage family) and *Fabaceae* (bean family).

The resulting share of 12 micro and macro elements – Ca, Na, K, Mg, Zn, Fe, Cu, Mn, Al, Ni, Pb and Cd from the five regions for both seasons were compared with data available in the literature through the highest and lowest average and individual values of each macro and micro elements, expressed in mg/kg (Table 2).

Prehrambena tehnologija i biotehnologija / Food Technology and Biotechnology

Table 2. The share of macro elements in the black locust honey of all the regions and both seasons

MINERAL SUBSTANCES	Ca (mg/kg)	Na (mg/kg)	K (mg/kg)	Mg (mg/kg)	Zn (mg/kg)	Fe (mg/kg)	Cu (mg/kg)	Mn (mg/kg)	Al (mg/kg)	Ni (mg/kg)	Pb (mg/kg)	Cd (mg/kg)
AVERAGE SHARE	33.526 - 329.327	23.343 - 218.042	205.571 - 428.050	12.295 - 49.072	0.937 - 30.875	0.495 - 2.268	0.068 - 0.951	0.090 - 0.229	0.859 - 3.376	0.086 - 1.861	0.024 - 0.107	0.003 - 0.011
LITERATURE	>	>	=	>	=	>	=	= ; <	/	>	= ; >	>
INDIVIDUAL SAMPLE	6.947 - 672.975	15.162 - 349.669	18.800 - 908.710	5.039 - 78.762	0.129 - 53.838	0.036 - 6.865	0.023 - 1.574	0.04 - 0.670	0.037 - 8.613	0.011 - 2.978	0.003 - 0.233	0.002 - 0.030
LITERATURE	>	>	=	/	/	/	>	<	/	/	=	= ; >

Table 3. The share of macro and micro elements in the black locust honey given the regions during both seasons(part I.)

SEASONS	REGION	MINERALS													SUMA
		SEASON	Ca (mg/kg)	Na (mg/kg)	K (mg/kg)	Mg (mg/kg)	Zn (mg/kg)	Fe (mg/kg)	Cu (mg/kg)	Mn (mg/kg)	Al (mg/kg)	Ni (mg/kg)	Pb (mg/kg)	Cd (mg/kg)	
1	VŽ	\bar{x}	126.187	87.321	336.872	12.900	1.053	0.895	0.184	0.229	1.196	0.197	0.065	0.006	
		?	81.854	40.684	106.611	7.385	0.452	0.796	0.088	0.096	0.318	0.177	0.042	0.004	
		CV (%)	154.16	46.59	31.65	57.25	42.97	88.97	47.71	41.80	26.57	89.87	64.20	62.51	
		\bar{x} (%)	22.25	15.40	59.40	2.27	0.19	0.16	0.03	0.04	0.21	0.03	0.01	0.00105	
2	VŽ	\bar{x}	87.704	128.181	292.543	23.028	7.190	0.818	0.260	0.161	2.051	0.142	0.050	0.004	
		?	56.712	83.782	80.193	14.035	4.818	0.569	0.190	0.092	1.480	0.038	0.035	0.002	
		CV (%)	64.66	65.36	27.41	60.95	67.01	69.52	73.31	56.98	72.17	26.70	70.64	54.77	
		\bar{x} (%)	16.18	23.65	53.98	4.25	1.33	0.15	0.05	0.03	0.38	0.03	0.01	0.00073	
1	KZ	\bar{x}	94.849	64.758	205.571	18.089	8.582	0.540	0.314	0.112	0.859	0.622	0.046	0.006	
		?	22.690	20.765	31.240	2.063	0.359	0.465	0.048	0.078	0.505	0.166	0.014	0.005	
		CV (%)	23.92	32.06	15.20	11.41	4.18	86.17	15.25	69.91	58.82	26.73	30.29	98.47	
		\bar{x} (%)	24.05	16.42	52.12	4.59	2.18	0.14	0.08	0.03	0.22	0.16	0.01	0.00152	
2	KZ	\bar{x}	61.288	72.018	271.053	17.989	0.984	0.601	0.260	0.090	1.446	0.128	0.039	0.003	
		?	49.086	68.354	74.834	10.838	0.426	0.399	0.170	0.072	0.371	0.082	0.025	0.001	
		CV (%)	80.09	94.91	27.61	60.25	43.30	66.41	65.22	79.99	25.64	64.26	64.52	33.71	
		\bar{x} (%)	14.39	16.91	63.64	4.22	0.23	0.14	0.06	0.02	0.34	0.03	0.01	0.00070	

Prehrambena tehnologija i biotehnologija / Food Technology and Biotechnology

Table 3. The share of macro and micro elements in the black locust honey given the regions during both seasons (part II.)

REGION	MINERALS													SUMA	
	SEASON	Ca (mg/kg)	Na (mg/kg)	K (mg/kg)	Mg (mg/kg)	Zn (mg/kg)	Fe (mg/kg)	Cu (mg/kg)	Mn (mg/kg)	Al (mg/kg)	Ni (mg/kg)	Pb (mg/kg)	Cd (mg/kg)		
1	BB	\bar{x}	43.000	23.543	235.479	12.207	0.937	0.527	0.094	0.215	1.017	0.134	0.028	0.004	
		?	33.240	7.132	26.807	6.249	0.437	0.418	0.038	0.097	0.778	0.092	0.013	0.003	
		CV (%)	77.30	30.55	11.38	51.19	46.66	79.44	40.94	45.39	76.49	68.45	48.37	72.65	-
		\bar{x} (%)	13.57	7.36	74.29	3.85	0.30	0.17	0.03	0.07	0.32	0.04	0.01	0.00126	-
2	BB	\bar{x}	36.683	26.789	210.597	16.681	1.099	2.147	0.085	0.179	3.376	0.088	0.024	0.003	
		?	10.221	4.883	70.223	7.915	0.891	1.671	0.024	0.115	2.734	0.060	0.013	0.001	
		CV (%)	27.86	18.23	33.34	47.45	81.10	77.85	28.74	64.36	80.99	68.79	52.24	19.88	-
		\bar{x} (%)	12.32	9.00	70.73	5.60	0.37	0.72	0.03	0.06	1.13	0.03	0.01	0.00100	-
1	IH	\bar{x}	329.327	218.042	293.542	49.072	30.875	1.007	0.951	0.218	1.163	1.861	0.107	0.011	
		?	199.517	106.497	79.306	20.188	23.041	0.815	0.654	0.125	0.462	1.265	0.065	0.008	
		CV (%)	60.58	48.84	27.02	41.14	74.63	80.93	68.81	57.35	39.70	68.01	60.80	67.95	-
		\bar{x} (%)	35.56	23.54	31.69	5.30	3.33	0.11	0.10	0.02	0.13	0.20	0.01	0.00118	-
2	IH	\bar{x}	39.444	119.682	428.050	12.295	2.039	1.751	0.068	0.161	1.280	0.095	0.043	0.005	
		?	9.919	88.642	249.778	3.334	1.626	1.116	0.039	0.069	1.235	0.039	0.035	0.007	
		CV (%)	25.15	74.06	58.35	27.11	79.73	63.74	57.11	42.88	96.51	41.14	80.38	146.41	-
		\bar{x} (%)	6.52	19.78	70.76	2.03	0.34	0.29	0.01	0.03	0.21	0.02	0.01	0.00082	-
1	I	\bar{x}	115.216	57.401	295.439	24.230	2.172	2.268	0.410	0.131	1.553	0.235	0.059	0.007	
		?	97.603	39.466	71.243	20.423	2.134	2.135	0.396	0.087	0.638	0.216	0.051	0.007	
		CV (%)	84.71	68.75	24.11	84.29	98.23	94.11	96.77	66.08	41.11	91.87	85.70	90.95	-
		\bar{x} (%)	23.10	11.51	59.23	4.85	0.44	0.45	0.08	0.03	0.31	0.05	0.01	0.00140	-
2	I	\bar{x}	33.526	45.843	418.864	12.803	1.037	0.495	0.168	0.160	1.969	0.086	0.031	0.003	
		?	14.439	8.215	121.020	3.583	0.407	0.216	0.051	0.137	0.789	0.052	0.017	0.000	
		CV (%)	43.07	17.92	28.89	27.99	39.20	43.57	30.16	85.97	40.06	60.07	53.93	0.00	-
		\bar{x} (%)	6.51	8.90	81.34	2.49	0.20	0.10	0.03	0.03	0.38	0.02	0.01	0.00058	-

The dominant mineral (out of 12) in the samples of black locust honey analysed in this study is K (205.571-428.050 mg/kg), followed by Ca (33.526-329.327 mg/kg) and Na (23.343-218.042 mg/kg) (Table 3).

The lowest average share of Ca can be found in I (33.526 mg/kg), whereas the highest in IH region (329.327 mg/kg) (season 1) which is greater than than the results in Slovenian (9.40 mg/kg) and Romanian black locust honey (3.05 mg/kg) (Golob et al., 2005; Marghitas et al., 2010). IH region is the region with the highest average value of the Na share (218.042 mg/kg), whereas the lowest value (23.343 mg/kg) is noted in BB region (season 1). In the samples of Romanian black locust honey it is less than (13.02 mg/kg) (Marghitas et al., 2010). The average share of K is the highest in (season 2) IH region (428.050 mg/kg), unlike KZ region (season 1) whose value presents the lowest mean value (205.571 mg/kg). Available literature data on the samples of Slovenian (390.00 mg/kg) and Romanian black locust honey (187.10 mg/kg) are of average equal to of this study (Golob et al., 2005; Marghitas et al., 2010). The highest (49.072 mg/kg) and the lowest (12.295 mg/kg) average share of Mg is in IH region (seasons 1 and 2). Marghitas and colleagues obtained less than value (5.7 mg/kg) (Marghitas et al., 2010). Very high value of the Zn share in relation to the other regions is visible in IH region (30.875 mg/kg), whereas (0.937 mg/kg) the lowest measured value (0.937 mg/kg) is in BB region (season 1). All the mean values of other regions during both seasons are equal to to mean values of Zn in Italian (0.178 mg/kg) and Romanian (1.85 mg/kg) black locust honey whereas in the Swiss samples (0.217 mg/kg) the values are slightly lower than the interval of this study (Caroli et al. 2000; Bogdanov et al., 2007; Marghitas et al. 2010). The lowest (season 2) and the highest (season 1) average share of Fe is in I region (0.495 mg/kg; 2.268 mg/kg) equal to the value of the samples of Romanian honey (1.30 mg/kg) (Marghitas et al., 2010). However, the average values of the Fe share in Swiss (0.278 mg/kg) and Italian honey (0.258 and 0.209 mg/kg) are lower than the ones in this study (Caroli et al., 2000; Forte et al., 2001; Bogdanov et al., 2007). The share of Cu (0.951 mg/kg) is noticeable in IH region (season 1), unlike the season 2 where this region has the lowest value (0.068 mg/kg). The other obtained mean values in other regions are equal to the available literature data (0.52; 0.18; 0.08 and 0.0576 mg/kg) (Forte et al., 2001; Bogdanov et al., 2007; Caroli et al., 2007; Marghitas et al., 2010). The average share of Mn given the regions and seasons is of approximately the same values with the lowest share in KZ (0.090 mg/kg season 2), and the highest (0.229 mg/kg) in VŽ (season 1) which is equal to the studies of Romanian honey (0.16 mg/kg), Swiss (0.453 mg/kg), two Italian (0.098 mg/kg; 0.09 mg/kg), whereas in Slovenian honey it is greater than (1.5 mg/kg) (Caroli et al., 2000; Forte et al., 2001; Golob et al., 2005; Bogdanov et al., 2007; Marghitas et al., 2010). KZ region denotes the lowest mean value (0.859 mg/kg) of Al in this study (season 1), whereas BB (season 2) is noticeable for the highest average share of Al (3.376 mg/kg). Among all the five regions in relation to Ni, the one that stands out (1,861 mg/kg) is IH region (season 1), whereas the lowest (0.086 mg/kg) in I region (season 2). The average shares of Ni of 0.056 mg/kg, 0.025 mg/kg and 0.018 mg/kg less than in relation to the values obtained in foreign studies (Caroli et al., 2000; Forte et al., 2001; Bogdanov et al., 2007). The share of Pb in all the regions of both seasons is of approximately equal values and ranges from the lowest of 0.024 mg/kg in BB region (season 2) to 0.107 mg/kg in IH region (season 1). Corresponding result with the abovementioned can be seen in Swiss (0.013 mg/kg) and Italian

Prehrambena tehnologija i biotehnologija / Food Technology and Biotechnology

honey (0.023 mg/kg) whereas Caroli and colleagues measure less than (0.0028 mg/kg) (Caroli et al., 2000; Forte et al., 2001; Bogdanov et al., 2007).

The mean value for Cd during both seasons in all the five regions ranges from the same value of 0.003 to 0.011 mg/kg. The results obtained by the Italian researchers are less than (0.0004 mg/kg and 0.0006 mg/kg) (Caroli et al., 2000; Forte et al., 2001).

The regulations regarding maximum levels for certain contaminants in food prescribe maximum levels for certain contaminants that may be present in certain foods, including heavy metals and non-metals, but maximum levels of lead or cadmium in honey are not prescribed (MZSS, 2008).

The share of macro and micro elements in the soil has been determined (Ca, Na, K, Mg, Zn, Fe, Cu, Mn, Al, Ni, Pb and Cd) (Table 4), and the results obtained are within the limits presented in the geochemical atlas of the Geological Survey (Halamić and Miko, 2009) except for the share of Fe in I region (greater than 100 times).

Table 4. The share of macro and micro elements in soil given the regions

REGION	MINERALS		Ca (mg/kg)	Na (mg/kg)	K (mg/kg)	Mg (mg/kg)	Zn (mg/kg)	Fe (mg/kg)	Cu (mg/kg)	Mn (mg/kg)	Al (mg/kg)	Ni (mg/kg)	Pb (mg/kg)	Cd (mg/kg)
	SEASON													
VŽ	\bar{x}		4365.200	515.010	888.250	3637.600	71.852	23038.500	19.337	558.470	12675.800	24.570	12.119	0.180
	?		2035.372	135.989	248.821	684.811	15.202	5302.369	6.080	253.096	4012.900	7.133	4.667	0.122
	CV (%)		46.63	26.41	28.01	18.83	21.16	23.02	31.44	45.32	31.66	29.03	38.51	67.62
KZ	\bar{x}		4427.336	482.840	452.795	2161.650	87.303	24177.960	18.314	504.750	6062.945	37.638	14.342	0.412
	?		2637.001	174.391	139.449	445.428	29.583	11068.554	4.196	203.189	2888.172	22.120	1.699	0.384
	CV (%)		59.56	36.12	30.80	20.61	33.89	45.78	22.91	40.26	47.64	58.77	11.85	93.29
BB	\bar{x}		2046.150	413.910	552.170	2470.900	64.338	21060.450	15.041	637.125	12087.550	21.153	11.260	0.094
	?		466.422	107.326	223.747	655.915	17.086	5967.788	6.384	354.683	3571.632	6.500	1.507	0.031
	CV (%)		22.80	25.93	40.52	26.55	26.56	28.34	42.44	55.67	29.55	30.73	13.38	33.50
IH	\bar{x}		4203.754	794.873	1877.047	5543.132	69.697	21355.230	14.615	485.374	13968.215	18.101	13.863	0.204
	?		2227.662	466.754	746.885	2339.622	37.135	5497.274	4.794	186.047	4766.931	5.060	6.917	0.085
	CV (%)		52.99	58.72	39.79	42.21	53.28	25.74	32.80	38.33	34.13	27.95	49.89	41.50
I	\bar{x}		5395.989	492.290	1486.055	1837.020	88.596	30842.300	37.585	765.865	23350.700	50.831	23.644	0.308
	?		6573.047	132.487	909.559	651.039	36.620	8740.091	15.972	232.709	18021.966	18.395	9.151	0.355
	CV (%)		121.81	26.91	61.21	35.44	41.33	28.34	42.50	30.39	77.18	36.19	38.70	115.40

Prehrambena tehnologija i biotehnologija / Food Technology and Biotechnology

Regression analysis revealed the statistically significant correlation only for Na and K regarding the share of minerals in the soil and honey among all the five regions and both seasons together (Table 5). Correlation of the share of Na in the soil and in honey during both seasons is best described by linear function with a correlation coefficient $r = 0.8434$. The correlation between the share of K in soil and honey during both seasons is best described by linear function and the correlation coefficient $r = 0.7348$ (Fig. 1, Fig. 2).

Table 5. Quantitative and qualitative correlation of the share of certain macro and micro elements in the soil (x) and honey (y) during both seasons

		r^*	R^2	Equation
M E T A L S	Ca	0.2021	0.0404	$y=0.0154x+33.877$
	Na	<i>0.8434</i>	0.7114	$y=0.3551x-107.39$
	K	<i>0.7348</i>	0.5400	$y=0.0983x+195.42$
	Mg	0.4522	0.2045	$y=0.0036x+8.7622$
	Zn	0.1576	0.0248	$y=-0.1422x+16.438$
	Fe	0.0538	0.0029	$y=1 \cdot 10^{-5}x+0.8657$
	Cu	0.0099	$9.7 \cdot 10^{-5}$	$y=-0.0003x+0.2854$
	Mn	0.0011	$1.19 \cdot 10^{-6}$	$y=5 \cdot 10^{-7}x+0.1653$
	Al	0.1998	0.0388	$y=3 \cdot 10^{-5}x+1.2501$
	Ni	0.2562	0.0657	$y=-0.011x+0.6942$
	Pb	0.0032	$1.02 \cdot 10^{-5}$	$y=2 \cdot 10^{-5}x+0.049$
	Cd	0.0196	0.0004	$y=0.0004x+0.0051$

r^* - the correlation coefficient

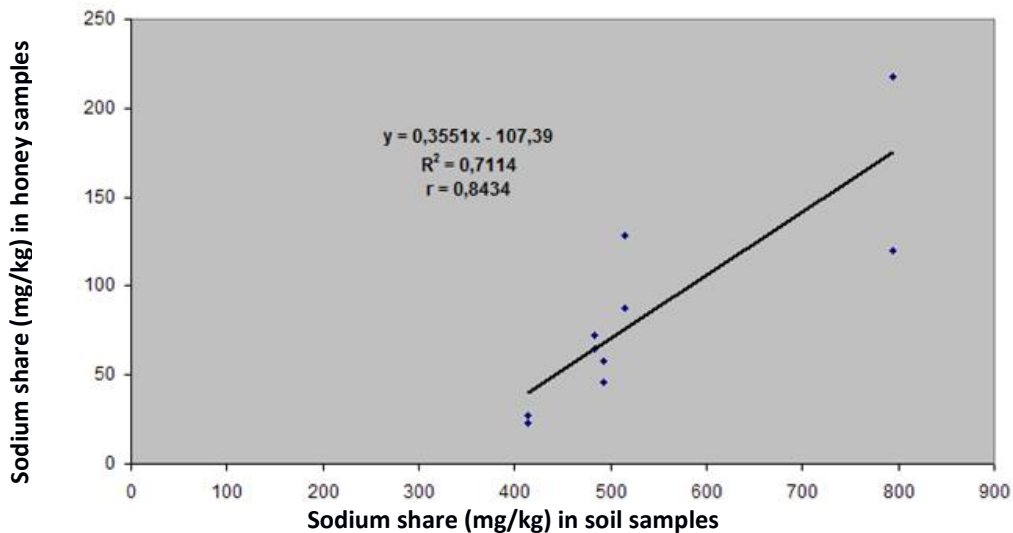

Fig. 2. Qualitative and quantitative correlation of the Na share in the soil and honey in all the studied samples (shown on the basis of the mean values of the Na share given the regions and seasons)

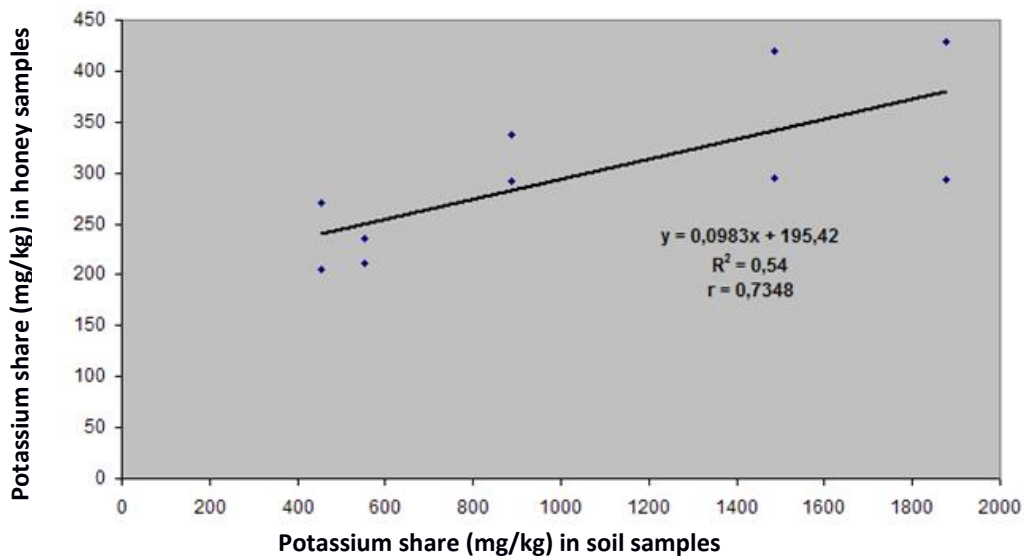

Fig. 3. Qualitative and quantitative correlation of the K share in the soil and honey in all the studied samples (shown on the basis of the mean values of the K share given the regions and seasons)

Conclusions

The conducted melissopalynological analysis confirmed the botanical origin of all the honey samples for both seasons and all the regions, with greater than 21 % of the family *Robinia* (black locust family), as declared by the manufacturer – black locust honey.

The share of most of the 12 macro and micro elements in analysed samples of black locust honey varied in wide ranges, as seen between the regions and within the region; the results correspond to the ranges of the same mentioned in the literature. Regarding the macro elements, the largest share belongs to K, followed by Ca and Na (K: 205.571-428.050 mg/kg, Ca: 33.526-329.327 mg/kg and Na: 23.343-218.042 mg/kg). Given the low share of contaminants Cd and Pb, Croatian honeys are not exposed to pollution by these metals.

The shares of 12 macro and micro elements in 100 samples of soil from the area of apiaries honey samples derive from are comparable with the values obtained by the Geological Survey, except for the share of Fe in the Istria region, where the value obtained was around 100 times higher.

Regression analysis confirmed the correlation between the share of minerals in the soil and honey only for Na and K, which is best described by linear function and characterised by the high correlation coefficients.

References

- Barišić, D., Vertačnik, A., Bromenshenk, J. J., Kezić, N., Lulić, S., Hus, M., Kraljević, P., Šimpraga, M., Seletković, Z. (1999): Radionuclides and selected elements in soil and honey from Gorski Kotar, Croatia, *Apidologie*. 30, 277-287.
- Belouali, H., Bouaka, M., Hakkou, A. (2008): Determination of some major and minor elements in the east of Morocco honeys through Inductively Coupled Plasma optical Emission Spectrometry, *Apiacta*. 43, 17-24.
- Bogdanov, S., Haldemann, M., Luginbühl, W., Gallmann, P. (2007): Minerals in honey: environmental, geographical and botanical aspects. *J. Apic. Res.* 46, 269-275.
- Caroli, S., Forte, G., Alessandrelli, M., Cresti, R., Spagnoli, M., D'Ilio, S., Pauwels, J., Kramer, G. N. (2000): A pilot study for the production of a certified reference material for trace element in honey. *Microchem. J.* 67, 227-233.
- Conti, M. E. (2000): Lazio region (central Italy) honeys: a survey of mineral content and typical quality parameters. *Food Control*. 11, 459-463.
- Conti, M. E., Stripeikis, J., Campanella, L., Cucina, D., Tudino, M. B. (2007): Characterization of Italian honeys (Marche region) on the basis of their mineral content and some typical quality parameters. *Chem. Cent. J.* 1, 1-17.
- Deutsches Institut für Normung: Determination of relative pollen content of honey. DIN 10760:2002-05.
- Fernandez-Torres, R., Perez-Bernal, J. L., Bello-Lopez, M. A., Callejon-Mochon, M., Jimenez-Sanchez, J. C., Guiraum-Perez, A. (2005): Mineral content and botanical origin of Spanish honeys. *Talanta*. 65, 686-691.
- Forte, G., D'Ilio, S., Caroli S. (2001): Honey as a Candidate Reference Material for Trace Elements. *J. AOAC Int.* 84, 1972-1975.

- Fredes, C., Montenegro, G. (2006): Heavy metals and other trace elements contents in Chilean honey. *Cienc. Investig. Agrar.* 33, 50-58.
- Golob, T., Doberšek, U., Kump, P., Nečemer, M. (2005): Determination of trace and minor elements in Slovenian honey by total reflection X-ray fluorescence spectroscopy. *Food Chem.* 91, 593-600.
- Gonzalez Paramas, A. M., Gomez Barez, J. A., Garcia-Villanova, R. J., Rivas Pala, T., Ardanuy Albajar, R., Sanchez Sanchez, J. (2000): Geographical discrimination of honeys by using mineral composition and common chemical quality parameters. *J. Sci. Food Agric.* 80, 157-165.
- Halamić, J., Miko, S. (2009): Geokemijski atlas Republike Hrvatske. Hrvatski geološki institut, Zagreb.
- Hernandez, O. M., Fraga, J. M. G., Jimenez, A. I., Jimenez, F., Arias, J. J. (2005): Characterization of honey from the Canary Islands: determination of the mineral content by atomic absorption spectrophotometry. *Food Chem.* 93, 449-458.
- Lachman, J., Kolišova, D., Miholova, D., Kosata, J., Titera, D., Kult, K. (2007): Analysis of minority honey components: Possible use for the evaluation of honey quality. *Food Chem.* 101, 973-979.
- Marghitas, L. A., Dezmirean, D. S., Pocol, C. B., Ilea, M., Bobis, O., Gergen, I. (2010): The Development of a Biochemical Profile of Acacia Honey by Identifying Biochemical Determinants of its Quality. *Not. Bot. Horti. Agrobi.* 38, 84-90.
- Merin, U., Bernstein, S., Rosenthal, I. (1998): A parameter for quality of honey. *Food Chem.* 63, 241-242.
- Ministarstvo poljoprivrede, ribarstva i ruralnog razvoja RH (Croatian Ministry of Agriculture): Pravilnik o kakvoći uniflornog meda, Narodne novine 122/09, 2009.
- Ministarstvo zdravstva i socijalne skrbi RH (Croatian Ministry of Health): Pravilnik o najvećim dopuštenim količinama određenih kontaminanata u hrani. Narodne novine 154/08, 2008.
- Muñoz, E., Palmero, S. (2005): Determination of heavy metals in honey by potentiometric stripping analysis and using a continuous flow methodology. *Food Chem.* 52, 313-319.
- Nozal Nalda, M. J., Bernal Yague, J. L., Diego Calva, J. C., Martin Gomez, M. T. (2005): Classifying honeys from the Soria province of Spain via multivariate analysis. *Anal. Bioanal. Chem.* 382, 311-319.
- Pisani, A., Protano, G., Riccobono, F. (2008): Minor and trace element in different honey types produced in Siena country (Italy). *Food Chem.* 107, 1553-1560.
- Perkin Elmer, ELAN ICP-MS Series Manuals, SCIEX, USA, 2008.
- StatSoft Inc., STATISTICA 9.1., Single user version, University of Zagreb, 2010.
- Šarić, G., Marković, K., Major, N., Krpan, M., Uršulin-Trstenjak, N., Hruškar, M., Vahčić, N. (2012): Changes of Antioxidant Activity and Phenolic Content in Acacia and Multifloral Honey During Storage. *Food Technol. Biotech.* 50 (4), 434-441.
- Terrab, A., Escudero, M. L., Gonzalez, M. M. L., Heredia, F. J. (2004): Colour characteristics of honeys as influenced by pollen grain content: a multivariate study. *J. Sci. Food Agric.* 84, 380-386.
- Tuzen, M., Silici, S., Mendil, D., Soylak, M. (2007): Trace element levels in honeys from different regions of Turkey. *Food Chem.* 103, 325-330.

Prehrambena tehnologija i biotehnologija / Food Technology and Biotechnology

- Uršulin-Trstenjak, N., Hrga, I., Stjepanović, B., Dragojlović, D., Levanić, D. (2013): Determination of botanic origin of the Croatian black locust honey (Istria region) using melissopalynological analysis. *J. Hyg. Eng. Design.* 4, 122-126.
- Üren, A., Şerifoğlu, A., Sarıkahya, Y. (1998): Distribution of elements in honeys and effect of a thermoelectric power plant on the element contents. *Food Chem.*, 61, 185-190.

Sekcija: Medicinska kemija i farmacija
Session: Medical Chemistry and Pharmacy

Izvorni znanstveni rad

Utjecaj flavonoida iz cvijeta *Prunus spinosa* L. i Whey proteina na oksidacijsko/antioksidacijski status u C57BL/6 miša

Irena Landeka Jurčević^{1*}, Domagoj Đikić², Vedran Balta², Ivona Paradžik¹, Lea Sabljčić¹

¹Sveučilište u Zagrebu, Prehrambeno-biotehnoški fakultet Zagreb,
Pierottijeva 6, 10 000 Zagreb, Hrvatska

²Sveučilište u Zagrebu, Prirodoslovno-matematički fakultet Zagreb,
Rooseveltova trg 6, 10 000 Zagreb, Hrvatska

*Dopisni autor: ilandeka@pbf.hr

Sažetak

Ova studija je provedena kako bi se procijenili učinci visoko-proteinske dijeta (Whey protein - WP) i flavonoida izoliranih iz cvijeta *Prunus spinosa* L. na različite biljege oksidacijskog stresa u jetri i bubregu miša. Pri normalnim fiziološkim uvjetima stanični sustav je sposoban neutralizirati slobodne radikale katalitičkim uklanjanjem reaktivnih kisikovih vrsta (ROS-a) djelovanjem antioksidacijskih enzima. Antioksidacijsko djelovanje Whey proteina (WP) bazirano je na visokom sadržaju i bioiskoristljivosti aminokiseline cistein koja pomaže u sintezi glutaciona (GSH), moćnog unutarstaničnog antioksidansa. Djelovanje WP i flavonoida izoliranih iz cvijeta trnina (ECT) istraženo je na laboratorijskim životinjama (C57BL/6 miš) kroz 30 dana tretmana. Životinje su bile podijeljene u 4 grupe: grupa I – kontrolna grupa (KO); grupa II – ekstrakt cvijeta trnina (ECT); grupa III – Whey protein (WP) i grupa IV – WP+ECT. Istraživani biomarkeri oksidacijskog stresa u organima bili su malonildialdehid (MDA) i reducirani glutation (GSH). Rezultati pokazuju da je tretman s ECT statistički značajno smanjio aktivnosti MDA u organima miša u odnosu na kontrolnu skupinu životinja, dok su ostale grupe ostale na razini kontrolne skupine. Koncentracije reduciranog glutaciona (GSH) u ispitivanim organima statistički su značajno (ANOVA, $p < 0,05$) povećane u svim grupama u odnosu na kontrolnu grupu. Ovi rezultati ukazuju na to da ekstrakt cvijeta trnina i proteini sirutke mogu djelovati kao nutritivni sastojak za povećanje endogenih antioksidacijskih enzima i smanjenje oksidacijskog stresa.

Ključne riječi: *Prunus spinosa* L., Whey protein, lipidna peroksidacija, reducirani glutation

Uvod

Trnina (*Prunus spinosa* L.) je samonikla biljka koja raste u gotovom svim dijelovima Europe. Cvijet trnina bogat je polifenolima, spojevima koji imaju izrazito jako antioksidacijsko djelovanje, poput kvercetina, kamferola i rutina. Blagotvorni učinak polifenola na organizam proizlazi iz sposobnosti vezanja slobodnih radikala (antioksidacijsko djelovanje), keliranja metala (vezanje dvovalentnih kationa) te inaktivacije određenih enzima zbog čega im se pripisuju antibakterijska, antikancerogena, antialergijska i protuupalna svojstva (Valls i sur., 2009).

Medicinska kemija i farmacija / Medical Chemistry and Pharmacy

Oksidacijski stres, koji se definira kao posljedica neravnoteže između stvaranja reaktivnih kisikovih vrsta (ROS) i antioksidacijske obrane organizma, povezan je s oštećenjima različitih molekula uključujući lipide, proteine i nukleinske kiseline. Oksidacijski stres u stanicama određuje se aktivnošću i koncentracijom antioksidacijskih enzima, kao što su superoksid dismutaza, katalaza, reducirani glutation, te koncentracijom karboniliranih proteina i malondialdehida (marker lipidne peroksidacije). Navedeni enzimi neophodni su za zaštitu stanica od toksičnog djelovanja reaktivnih kisikovih vrsta koje se stvaraju tijekom metabolizma. Istraživanja su pokazala da visoko-proteinska dijeta u kojoj su korišteni proteini sirutke smanjuje oksidacijski stres u životinja i povećava mitohondrijsku aktivnost u mozgu (Shertzer i sur., 2013).

Svjetska zdravstvena organizacija (World Health Organization-WHO) i Organizacija za hranu i poljoprivredu Ujedinjenih Naroda (Food and Agriculture Organization of the United Nations-FAO) 2007. godine definirali su preporučeni dnevni unos proteina koji iznosi 0,8 g proteina po kilogramu tjelesne mase čovjeka, što je otprilike 10% preporučenog dnevnog unosa energije. Visoko-proteinska dijeta (više od 2-3 grama proteina po kilogramu tjelesne mase) često se preporuča kao dijeta koja se koristi za redukciju tjelesne mase i održavanje dobrog zdravlja. Rezultati različitih provedenih studija (Journal i sur., 2012; Kinsey-Jones i sur., 2015; Santesso i sur., 2012) pokazuju da povećanje unosa proteina u prehrani smanjuje ukupan unos energije, što dovodi do redukcije tjelesne mase.

Prednost Whey proteina u odnosu na druge proteine je u brznoj apsorpciji u crijevima, što u konačnici rezultira sintezom proteina koji izgrađuju mišiće (Mansour i sur., 2015). Jedan od najznačajnijih efekata koje proteini sirutke izazivaju u organizmu je njihova sposobnost da podiže koncentraciju glutationa (GSH), koji je najvažniji u vodi topljiv antioksidans koji se nalazi u tijelu. Tijekom intenzivnog vježbanja, visok udio aminokiselina donatora sulfidrilnih skupina može reducirati intracelularne koncentracije GSH. Unos proteina sirutke ne samo da može usporiti oksidacijski stres induciran vježbanjem, nego i može pomoći u održavanju redoks statusa u imunološkim stanicama budući da one mogu biti osjetljive na koncentracije unutarstaničnih sulfhidrilnih spojeva, GSH i cisteina. Učinak ovog mehanizma potvrđen je eksperimentalnim dokazima (Marshall, 2004).

Whey proteini se smatraju i izvorom aminokiselina, budući da sadrže do 26% aminokiselina razgranatog lanca - BCAA (valin, leucin, izoleucin), te L-arginina, L-lizina, L-glutamina, cisteina, laktoalbumina, laktozu, mineralne tvari i lipide u tragovima. Prema tome, učinci proteina sirutke u imunološkom sustavu mogu predstavljati učinak pojedinih aminokiselina samih po sebi. Osim toga, proteini sirutke se brzo probavljaju i apsorbiraju, što poslije unosa rezultira sintezom proteina koji izgrađuju mišiće (Nada i sur., 2015.; Burd i sur., 2012.). Proteini sirutke imaju mnoge pozitivne učinke na organizam, kao što su kontrola metabolizma glukoze u zdravih osoba, regulacija prekomjerne tjelesne mase, hipertenzije i oksidacijskog stresa. Također, dolazi do smanjenja ekspresije upalnih i oksidacijskih markera stresa, kao i do smanjenja krvnog tlaka (Sousa i sur., 2012).

Cilj ovog rada bio je ispitati antioksidacijski utjecaj polifenola ekstrakta cvijeta trnine (*Prunus spinosa L.*) i visoko-proteinske dijetete (Whey protein) na markere oksidacijskog stresa u jetri i bubregu C57BL/6 miša.

Materijali i metode

Pokusne životinje

Pokusi su provedeni na životinjama iz jedinice za uzgoj laboratorijskih životinja Prirodoslovno-matematičkog fakulteta, Sveučilišta u Zagrebu. Pokusne životinje bile su C57BL/6 miševi, u dobi od tri mjeseca. U ovo istraživanje ukupno je bilo uključeno 20 životinja. Životinje su hranjene tijekom 30 dana. Po pet životinja je bilo smješteno u kavezu, na temperaturi od 22°C, uz neograničen pristup hrani i vodi. Životinje su hranjene komercijalno dostupnom hranom koja je životinjama bila dostupna *ad libitum*. Životinje su držane u slijedećim uvjetima: 12 sati svjetla i 12 sati tame pri 22 °C i 60% vlažnosti. Hrana kojom su hranjeni miševi je standardna hrana za miševe 4RF21 (Mucedola, Italija, oblik 12 mm), a sadrži pšenicu, kukuruz, soju, riblji ekstrakt, dikalcijev fosfat, kalcijev karbonat, natrijev klorid, sojino ulje, kvasac i ljuške lješnjaka. Održavanje i njega svih pokusnih životinja provedena je u skladu sa smjernicama koje su na snazi u Republici Hrvatskoj (Zakon o dobrobiti životinja, NN #135, 2006 i Pravilnikom o zaštiti životinja koje se koriste u pokusima ili druge znanstvene svrhe, NN #47, 2011), a provodi se u skladu s Uputama za njegu i korištenja laboratorijskih životinja, DHHS Publ. #(NIH) 86-123. Pokuse je odobrilo Etičko povjerenstvo Prirodoslovno-matematičkog fakulteta, Sveučilišta u Zagrebu (No. 251-58-10617-14-21).

Eksperimentalne grupe životinja

Eksperimentalne grupe su činile četiri grupe životinja (5 životinja po grupi): KO – Kontrolna grupa (0,3 mL fiziološke otopine); ECT – Ekstrakt cvijeta trnine (100 mg/kg na dan); WP – Whey protein (40% koncentracija proteina; 400 g/kg na dan); WP + ECT– Ekstrakt cvijeta trnine + Whey protein. Životinje su žrtvovane 30.-ti dan pokusa te su uzeti organi bubrega i jetre za daljnju analizu. Životinje su anestetizirane eterom te su iskrvarene punkcijom iz srca bez antikoagulansa. Bubrezi i jetra su izolirani iz životinja odmah nakon skupljanja uzorka krvi. Izvagani su, zabilježena je masa i potom su pohranjeni na -80°C za daljnju analizu.

Priprema tkiva za određivanje antioksidacijskih enzima

Svježe tkivo homogenizira se u 50 mM fosfatnom puferu pH 7 u omjeru 1 : 10 (w/v). Organi se potom homogeniziraju na ultrazvučnom homogenizatoru u 3 ciklusa od po 30 sekundi uz stanku od 10 sekundi između ciklusa. Uzorke je potrebno cijelo vrijeme držati na ledu. Homogenate bubrega i jetre potom je potrebno centrifugirati pri 20 000 x g tijekom 15 min na 4°C.

Mjerenje lipidne peroksidacije

Prisutnost lipidne peroksidacije smo određivali modificiranom metodom koju su opisali Jayakumar i sur., 2008. Ova metoda se temelji na mjerenju koncentracije malondialdehida (MDA) koji je jedan od glavnih produkata lipidne peroksidacije. Malondialdehid reagira sa tiobarbiturnom kiselinom i stvara kromogen koji je moguće mjeriti spektrofotometrijski. Uzorcima jetre i bubrega mase 100 mg dodali smo 1 mL 50 mM fosfatnog pufera (pH 7.0) i homogenirali ultrazvučnim homogenizatorom Bandelin Sonoplus HD2070 (Bandelin, Njemačka) upotrebom sonde MS73 (Bandelin, Njemačka), snagom od 10%. Homogenate smo centrifugirali centrifugom Mikro 200R (Hettich, Njemačka) 15 minuta pri brzini od 10 000 rpm. 200 µL supernatanta pomiješali smo sa 200 µL 8,1%-tne vodene otopine SDS-a, 1,5 mL 20%-tne vodene otopine octene kiseline (pH 3.5) i 1,5 mL 0.81%-tne

Medicinska kemija i farmacija / *Medical Chemistry and Pharmacy*

vodene otopine tiobarbiturne kiseline. Smjesu smo zagrijavali 60 minuta pri temperaturi od 95 °C. Ohlađenim uzorcima izmjerili smo apsorbanciju pri 532 nm i 600 nm spektrofotometrom Libro S22 (Biochrom, Ujedinjeno Kraljevstvo). Ukupnu apsorbanciju određivali smo prema formuli $A = A(532 \text{ nm}) - A(600 \text{ nm})$. Koncentraciju smo izračunali prema formuli:

$$c(\text{MDA}) = A \times V_{\text{uzorka}} (\text{mL}) / \varepsilon \times V_{\text{reakcijske smjese}} (\text{mL}) \times c_{\text{proteina}} (\text{mg/mL}) \quad (1)$$

gdje: ε iznosi $1,56 \times 10^5$ 1/M cm, a duljina kivete l iznosi 1 cm. Koncentraciju lipidnih peroksida izrazili smo kao nmol MDA/mg proteina.

Aktivnost reduciranog glutationa

Postupak određivanja koncentracije GSH se temelji na reakciji GSH i DNTB-a (5,5'-ditiobis-2-nitrobenzojeva kiseline). DNTB je poznat i kao Ellmanov reagens, a koristi se pri kolorimetrijskom određivanju tiolnih skupina u biološkim uzorcima. Ellmanov reagens uzrokuje oksidaciju GSH pri čemu dolazi do stvaranja veće količine 2-nitro-5-tiobenzoatne kiseline (NTB) i male količine glutation disulfida (GSSG). NTB je žuto obojeni produkt koji se mjeri na Plate Reader-u pri 412 nm, a na temelju čega indirektno dobivamo podatak o koncentraciji GSH (Eyer i sur. 2003). Koncentraciju smo izračunali prema formuli:

$$c = \Delta A \times V_{\text{uzorka}} (\text{mL}) / \varepsilon \times V_{\text{reakcijske smjese}} (\text{mL}) \times c_{\text{proteina}} (\text{mg/mL}) \quad (2)$$

gdje ε (DTNB) iznosi 8,22 1/mM cm, a duljina kivete l iznosi 0,6 cm. Koncentraciju proteina u uzorku izmjerili smo metodom po Lowryju (Lowry i sur., 1951). Aktivnost enzima reduciranog glutationa (GSH) smo izrazili kao mU/mg.

Statistička analiza

Statističku analizu podataka smo napravili koristeći Microsoft Excel 2011 (Redmond, Sjedinjenje Američke Države) i StatSoft Statistica 7.0 (Tulza, Sjedinjenje Američke Države). Dobivene podatke smo izražavali u obliku srednja vrijednost \pm standardna devijacija srednje vrijednosti. Višestruku usporedbu kontrolne i tretiranih skupina miševa izvršili smo ANOVA analizom varijance. Interval pouzdanosti namjestili smo na $p \leq 0,05$. Post-hoc analize smo izvršili koristeći Tukey test kako bismo ustanovili razlike između pokusnih grupa. Analiza je provedena pomoću SPSS verzija 17 (SPSS Inc, Chicago, IL).

Rezultati i rasprava

Utjecaj polifenola iz ekstrakta cvijeta trnine i visoko-proteinske dijeta na lipidnu peroksidaciju u homogenatu tkiva jetre i bubrega u C57BL/6 miša

Proces lipidne peroksidacije je oblik oksidacijske promjene polinezasićenih masnih kiselina koji rezultira nastankom citotoksičnih produkata, a jedan od njih je malondialdehid (MDA). MDA je prihvaćeni biljeg lipidne peroksidacije te se koristi u evaluaciji oksidacijskog stresa (Bukan i sur., 2003). Na slici 1. i 2. prikazani su rezultati nefroprotektivnog i hepatoprotetivnog utjecaja polifenola iz ekstrakta cvijeta trnine i Whey proteina na aktivnost MDA u homogenatu tkiva bubrega i jetre C57BL/6 miša.

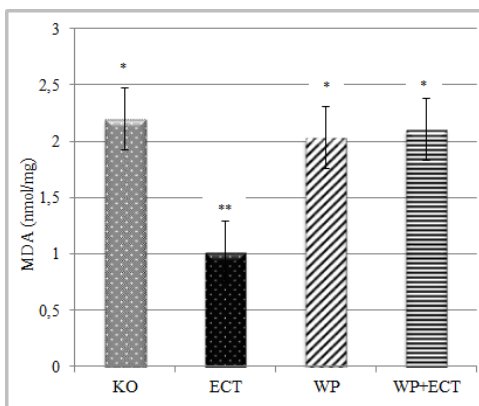

Slika 1. Koncentracija MDA u homogenatima tkiva bubrega kod kontrolne i tretiranih skupina životinja u odnosu na kontrolu. Rezultati su izraženi kao srednja vrijednost \pm SD.

* – razlike između tretmana; $p < 0,05$ (ANOVA).

KO – kontrolna grupa; ECT – ekstrakt cvijeta trnine; WP – whey proteini

Fig. 1. MDA concentration in the tissues of the kidney of the control animals and the treated groups compared to the control. Values are expressed as means \pm SD.

* – differences between treatments; $p < 0.05$ (ANOVA).

KO - control group; ECT - Flower Extract Trnina; WP - whey proteins

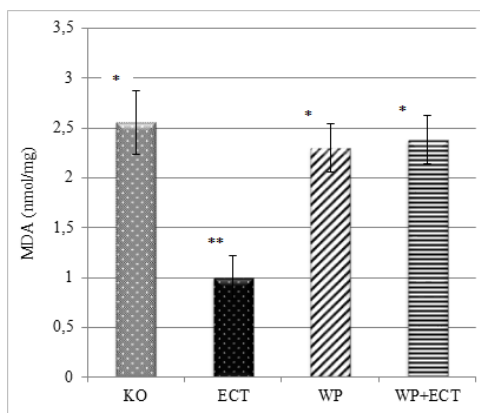

Slika 2. Koncentracija MDA u homogenatima tkiva jetre kod kontrolne i tretiranih skupina životinja u odnosu na kontrolu. Rezultati su izraženi kao srednja vrijednost \pm SD.

* – razlike između tretmana; $p < 0,05$ (ANOVA).

KO – kontrolna grupa; ECT – ekstrakt cvijeta trnine; WP – whey proteini

Fig. 2. MDA concentration in the tissues of the liver of the control animals and the treated groups compared to the control. Values are expressed as means \pm SD.

* – differences between treatments; $p < 0.05$ (ANOVA).

KO - control group; ECT - Flower Extract Trnina; WP - whey proteins

Medicinska kemija i farmacija / *Medical Chemistry and Pharmacy*

Statistički značajno smanjenje (ANOVA, $p < 0.05$) aktivnosti MDA zabilježeno je kod grupe koja je primala ekstrakt cvijeta trnine u homogenatu tkiva bubrega ($1,020 \pm 0,18$ nmol/ mg) u odnosu na kontrolnu grupu životinja ($2,196 \pm 0,24$ nmol/mg) (slika 1) i u homogenatu tkiva jetre ($0,999 \pm 0,22$ nmol/mg) u odnosu na kontrolnu grupu životinja ($2,551 \pm 0,35$ nmol/mg) (slika 2). Smanjenje koncentracije MDA zabilježeno je i kod grupa koje su primale visoko-proteinsku dijetu ($2,032 \pm 0,28$ nmol/mg) i kombinaciju visoko-proteinske dijetete i ekstrakta cvijeta trnine ($2,102 \pm 0,22$ nmol/mg) u homogenatu tkiva bubrega (slika 1) i kod grupa koje su primale visoko-proteinsku dijetu ($2,298 \pm 0,24$ nmol/mg) i kombinaciju visoko-proteinske dijetete i ekstrakta cvijeta trnine ($2,384 \pm 0,24$ nmol/mg) u homogenatu tkiva jetre u odnosu na kontrolnu grupu (slika 2).

Višestruko nezasićene masne kiseline su često meta stvorenih slobodnih radikala. Ustanovljeno je da tkiva koja su izložena oksidacijskom stresu brže ulaze u lipidnu peroksidaciju, a razlog veće peroksidabilnosti uključuje inaktivaciju, odnosno manjak antioksidacijskih mehanizama (Štefan i sur., 2007). Kemijska modifikacija aminokiselina u proteinima tijekom lipidne peroksidacije rezultira formiranjem lipooksidacijskih produkata koji služe kao markeri oksidacijskog stresa *in vivo*. MDA reagira s proteinima krvnih žila npr. s kolagenom i dovodi do promjena u njegovoj strukturi (Tiku i sur., 2003.). Mnoge su studije pokazale da je koncentracija MDA znatno povišena kod dijabetesa (Slatter i sur., 2000.). Petlevski i suradnici proveli su studiju kojoj je cilj bio ispitati učinak akarboze (inhibitor α -glukozidaze) na koncentraciju glukoze u serumu i MDA u homogenatu jetre NOD (engl. non-obese diabetic) miša. U NOD miševa je dijabetes induciran *in vivo* aplikacijom aloksan-monohidrata (75 mg/kg tjelesne mase). Nakon sedmodnevnog tretmana akarbozom zabilježeno je statistički značajno smanjenje koncentracije glukoze u krvi u skupini dijabetičnih NOD miševa tretiranih akarbozom u odnosu na skupinu dijabetičnih NOD miševa, a isto tako je uočen i statistički značajan pad koncentracije MDA (Petlevski i sur., 2006).

Pozitivni efekti aronije i njenih proizvoda na markere oksidacijskog stresa ispitivani su u malom broju dijetetskih interventnih studija kod ljudi. Rezultati tih studija potencijalno antioksidacijsko djelovanje baziraju upravo na smanjenju koncentracije MDA. Značajno smanjenje koncentracije MDA u serumu pokazano je nakon 8 tjedana konzumacije ekstrakta aronije kod ispitanika s metaboličkim sindromom (Broncel i sur., 2010), kao i kod veslača koji su konzumirali sok od aronije prije izvođenja ergonometrijskog testa (Pilaczynska-Szczesniak i sur., 2005).

Rezultati većeg broja istraživanja podupiru pretpostavku o povezanosti lipidne peroksidacije (LPO) i nastanka karcinoma bubrega te svrstavaju karcinom bubrega u skupinu sa znatnim promjenama u ravnoteži oksidacijsko/antioksidacijskog sustava. Gago-Dominguez i Castela (2006) su predložili LPO kao jednu od ključnih čimbenika u razvoju karcinoma bubrega. Naime, reaktivne kisikove vrste (RKV) koje uzrokuju LPO oštećuju i DNA izazivajući genetske mutacije, aktiviraju protoonkogene i/ili inaktiviraju tumor supresorske gene te mogu dovesti do preobrazbe zdrave u zloćudnu stanicu. Opisani proces karakterističan je za sporo proliferirajuća tkiva (npr. jetra, bubreg). Zdravo tkivo bubrega u čovjeka sadrži veliki broj peroksisoma. U stanicama karcinoma bubrega peroksisomi su potpuno odsutni. Posljedica nedostatka peroksisoma je narušeni metabolizam masnih kiselina (Grabacka i Reiss, 2008.).

Pad koncentracije MDA u jetri pronađen je i kod zdravih štakora koji su tretirani prehranom bogatom polifenolima iz voća poput jagoda ili šljiva u usporedbi s kontrolnom grupom životinjama (Mateos i sur., 2005). Diamanti i sur. su istraživali utjecaj dvije različite sorte jagoda (Adria i Sveva) na toksičnost u štakora izazvanu doksorubicinom (DOX). Doksorubicin je drastično povećao

oštećenja DNA, lipidnu peroksidaciju i sadržaj mitohondrijskih reaktivnih kisikovih vrsta (ROS), te je značajno smanjio aktivnost antioksidacijskih enzima i mitohondrijske funkcije. Dva mjeseca nakon što su životinja tretirane jagodama, došlo je do značajnog smanjenja oštećenja DNA i koncentracije ROS i značajnog poboljšanja markera oksidacijskog stresa, aktivnosti antioksidacijskih enzima i mitohondrijske performanse. Autori su zaključili da se unosom jagoda može utjecati na toksičnost izazvanu doksorubicinom, ta da povećani unos jagoda ima potencijalne zdravstvene benefite od oksidacijskog stresa *in vivo* (Diamanti i sur; 2014.). Sličan pad MDA u jetri pronađen je i kod zdravih štakora koji su tretirani prehranom bogatom polifenolima iz voća poput jagoda ili šljiva u usporedbi s kontrolnom grupom životinjama (Mateos i sur., 2005).

U skladu s prethodnim istraživanjima, u ovom istraživanju, snižena razina MDA u homogenatu tkiva bubrega i jetre kod grupe životinja koja je uz normalnu prehranu dobivala i ekstrakt cvijeta trnine pokazuje značajan pad lipidne peroksidacije u odnosu na kontrolnu grupu životinja što ukazuje na antioksidacijski učinak ekstrakta cvijeta trnine koji je bogat polifenolima. Grupe životinja koje su tretirane WP i WP+TC također nisu izazvale oksidacijski stres. Ovi se rezultati mogu objasniti činjenicom da polifenoli štite stanice od lipidne peroksidacije, ne samo u situacijama oksidacijskog stresa, nego i u normalnim uvjetima.

Utjecaj polifenola iz ekstrakta cvijeta trnine i Whey proteina na aktivnost GSH enzima u homogenatu tkiva (bubreg i jetra) miša

Reaktivni radikali kisika (ROS) stvaraju se tijekom različitih patoloških procesa u povećanim koncentracijama. Međutim, mehanizmi antioksidacijske zaštite, uključujući različite antioksidacijske enzime, sprječavaju oštećenja tkiva i druge komplikacije povezane s ROS-om. Antioksidacijska zaštita je važna u uklanjanju slobodnih radikala jer osigurava maksimalnu zaštitu bioloških mjesta kao što su tiolne skupine koje su dio aktivnih mjesta u nekim metabolizirajućim enzimima. Dobar antioksidans specifično potiskuje slobodne radikale, kelira redoks-metale, međusobno djeluje s drugim antioksidansima unutar antioksidacijske mreže, lako se apsorbira, ima fiziološki relevantnu koncentraciju u tkivima i biološkim tekućinama, te djeluje i u vodenim i/ili membranskim domenama (Valko i sur., 2006.). Polifenolni spojevi, koji se javljaju u izobilju u prehranbenim izvorima kao što su voće, povrće, čaj i vino, mogu imati važnu ulogu u jačanju antioksidacijskog djelovanja (Pandey i sur., 2009).

Na slikama 3. i 4. prikazani su rezultati utjecaja na aktivnost reduciranog glutationa (GSH) u bubregu i jetri tretiranih grupa životinja. Statistički značajno povećanje (ANOVA, $p < 0,05$) aktivnosti GSH zabilježeno je kod uzorka ekstrakt cvijeta trnine u homogenatu tkiva bubrega ($100,36 \pm 0,34$ mU/mg) u odnosu na kontrolnu grupu ($73,11 \pm 0,48$ mU/mg⁻), dok je statistički značajno povećanje zabilježeno i u grupama WP ($93,67 \pm 0,56$ mU/mg) i WP+TC ($89,17 \pm 0,42$ mU/mg) (slika 3) i u homogenatu tkiva jetre ($116,33 \pm 0,48$ mU/mg) u odnosu na kontrolnu grupu ($83,58 \pm 0,46$ mU/mg). Također, statistički značajno povećanje zabilježeno je u grupama koje su tretirane sa Whey proteinom ($110,46 \pm 0,44$ mU/mg), kao i WP+TC ($105,33 \pm 0,42$ mU/mg) (slika 4).

Medicinska kemija i farmacija / *Medical Chemistry and Pharmacy*

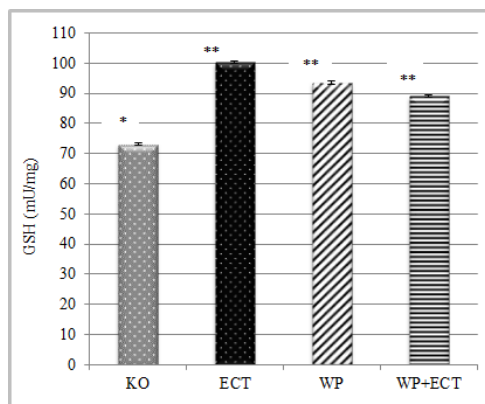

Slika 3. Koncentracija GSH u homogenatima tkiva bubrega kod kontrolne i tretiranih skupina životinja u odnosu na kontrolu. Rezultati su izraženi kao srednja vrijednost±SD.

* – razlike između tretmana; $p < 0,05$ (ANOVA).

KO – kontrolna grupa; ECT – ekstrakt cvijeta trnine; WP – whey proteini

Fig. 3. GSH concentration in the tissues of the kidney of the control animals and the treated groups compared to the control. Values are expressed as means±SD.

* – differences between treatments; $p < 0.05$ (ANOVA).

KO - control group; ECT - Flower Extract Trnina; WP - whey proteins

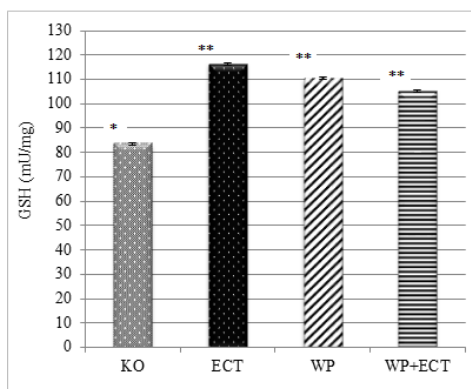

Slika 4. Koncentracija GSH u homogenatima tkiva jetre kod kontrolne i tretiranih skupina životinja u odnosu na kontrolu. Rezultati su izraženi kao srednja vrijednost±SD.

* – razlike između tretmana; $p < 0,05$ (ANOVA).

KO – kontrolna grupa; ECT – ekstrakt cvijeta trnine; WP – whey proteini

Fig. 4. GSH concentration in the tissues of the liver of the control animals and the treated groups compared to the control. Values are expressed as means±SD.

* – differences between treatments; $p < 0.05$ (ANOVA).

KO - control group; ECT - Flower Extract Trnina; WP - whey proteins

Oksidacijski stres je stanje promijenjene ravnoteže u oksidacijskom/antioksidacijskom statusu organizma u korist oksidacijskog stanja. Oksidacijski stres ima za posljedica nastanak oksidacijskih oštećenja proteina, lipida i DNA, što dovodi do promjene u staničnoj strukturi i funkciji, do pojave kroničnih nezaraznih bolesti poput kardiovaskularnih bolesti, degenerativnih bolesti, dijabetesa, karcinoma i raznih drugih patoloških stanja (Scalbert i sur., 2005.). Prema procjenama Svjetske zdravstvene organizacije (WHO) i Organizacije za hranu i poljoprivredu (FAO) kronične nezarazne bolesti su glavni uzrok prerane smrti u cijelom svijetu. Pojava nekroničnih zaraznih bolest povezuje se s neadekvatnom prehranom i nedovoljnom fizičkom aktivnošću. Namirnice biljnog porijekla bogate su biološki aktivnom tvarima, poput polifenola. Polifenoli predstavljaju najznačajnije antioksidanse s obzirom da su visoko zastupljeni u namirnicama i da imaju visoki antioksidacijski kapacitet.

Zahvaljujući cisteinu koji sadrži tiolnu skupinu, glutation je važan unutarstanični neenzimski antioksidans koji sudjeluje u prijenosu aminokiselina kroz plazmatsku membranu, izravno čisti singletni kisik i hidroksilni radikal te time detoksificira vodikov peroksid i lipidne perokside katalitičkim djelovanjem glutation peroksidaze (GPx). Glutation je obilato prisutan u citosolu (1-11 mM), jezgrama (3-15 mM) i mitohondrijima (5-11 mM) te je glavni topljivi antioksidans u staničnim odjeljcima. Unutarstanični sadržaj glutaciona ovisi o čimbenicima okoliša i funkcionira kao ravnoteža između njegova iskorištenja i sinteze. Izlaganje ROS-u i/ili spojevima koji mogu stvarati ROS, može povećati sadržaj GSH povećanjem brzine sinteze GSH (Valko i sur., 2006.).

Journel i sur. su promatrali utjecaj visoko-proteinske na mozak, odnosno kako visoko-proteinska dijeta utječe na sitost. Ovi znanstvenici smatraju da konzumacijom obroka bogatog proteinima postajemo brže siti i ostajemo dulje siti, nego što je to nakon konzumacije obroka bogatog drugim makronutrijentima (ugljikohidrati i masti). Nakon konzumacije proteina, peptidni hormoni se otpuštaju iz gastrointestinalnog trakta i šalju informacije mozgu o stanju energije. Peptidni hormoni kontroliraju unos hrane djelujući na područje mozga koji je uključen u homeostazu energije. Visoko-proteinska dijeta dovodi do veće aktivacije peptidnih hormona nego što bi dovela dijeta s normalnim unosom proteina. Budući da proteini imaju važnu ulogu u nastanku sitosti, autori smatraju da dugotrajna visoko-proteinska dijeta dovodi do smanjenja unosa hrane i do smanjenja tjelesne mase kod laboratorijskih životinja (Journel i sur., 2012.).

Ho i sur. su istraživali učinak visoko-proteinske dijeta na rast stanica raka. Smatra se da stanice raka više ovise o glukozu nego normalne stanice u organizmu, stoga su autori proučavali učinak nisko-ugljikohidratne dijeta i visoko-proteinske dijeta na brzinu rasta tumora kod miševa. Otkrili su da karcinom i kod miševa i kod ljudi raste puno sporije provođenjem visoko-proteinska dijeta, nego što bi to bilo provođenjem uobičajene prehrane (Ho i sur., 2011.).

Lipopolisaharidi (LPS), poznati i kao lipoglikani su velike molekule koje se sastoje od lipida i polisaharida. Nalaze se u vanjskim membranama gram-negativnih bakterija i izazivaju snažan imunogen odgovor kod životinja tj. stimuliraju sintezu i lučenje reaktivnih kisikovih vrsta i citokina. U studiji koju su proveli Mansour i suradnici ispitivan je učinak izolata proteina sirutke na lipopolisaharidom inducirani oksidacijski stres i akutno oštećenje jetre u štakora. Nakon izlaganja štakora LPS, rezultati su pokazali veliko oštećenje jetre tj. došlo je do porasta serumskih razina jetrenih enzima - alanin aminotransferaze (ALT) i aspartat aminotransferaze (AST). Izlaganje lipopolisaharidu rezultirao je povećanjem razine MDA, markera lipidne peroksidacije i povećanjem razine nitrita u hepatocitima te smanjenjem koncentracije glutaciona (GSH) u hepatocitima. Tretman

Medicinska kemija i farmacija / *Medical Chemistry and Pharmacy*

proteinima sirutke, nakon oksidacijskog stresa izazvanog LPS, rezultirao je poboljšanim funkcijama jetre što pokazuje pad serumskih razina jetrenih enzima AST i ALT. Također, izolati proteina sirutke smanjili su razinu nitrita i peroksidaciju lipida te povećali koncentraciju GSH u tkivu jetre. Autori su zaključili kako proteini sirutke mogu biti korisno farmakološko sredstvo za modulaciju oštećenja nastalih oksidacijskim stresom i akutnom ozljedom jetre (Mansour i sur., 2013).

Hesham i suradnici proučavali su djelovanje proteina sirutke (100-200 mg kg⁻¹) na štakore kojima je bila inducirana hepatotoksičnost primjenom paracetamola (500 mg kg⁻¹) i alkohola (5 ml kg⁻¹) tijekom dva i četiri tjedna, te su prikupljeni i analizirani tkivo jetre i plazma. Alkohol i paracetamol su povisili jetrene enzime (AST i ALT), no nakon što su štakori dobivali visoku dozu proteina sirutke došlo je do smanjenja serumskih enzima (AST i ALT) i MDA, dok su markeri oksidacijskog stresa GSH i SOD porasli. Autori su zaključili da oralna primjena proteina sirutke poboljšava induciranu hepatotoksičnost (Hesham i sur., 2014.).

U studiji koju su proveli Petzke i suradnici ispitivan je utjecaj visokog unosa proteina na povećanje oksidacijskog stresa u štakora. Životinje su bile podijeljene u 4 skupine: skupina koja je imala adekvatan unos proteina (13,8%), skupina koja je imala srednji unos proteina (25,7%), skupina koja je imala visoki unos proteina (51,3 %), te skupina koja je imala visoki unos proteina ali nije dobivala tokoferol acetat. Nakon 15 tjedana, skupinama su izmjerene koncentracije malonildialdehida (MDA), karboniliranih proteina (PC) i GSH. Koncentracija GSH u plazmi nije se značajno razlikovala između skupina, dok je jetrena koncentracija GSH bila značajno niža u skupini koja je imala adekvatan unos proteina. Povišena koncentracija karboniliranih proteina pronađena je u skupini koja je imala adekvatan unos proteina u usporedbi sa skupinom koja je imala srednji i visoki unos proteina. Dugotrajno uzimanje visoko-proteinske dijeta nije dovelo do povećanja markera oksidacijskog stresa (Ptzke i sur., 2000.).

Utjecaj izolata proteina sirutke na povećanje metabolizma energije u mozgu miša istraživali su Shertzer i suradnici. Kod miševa koji su hranjeni izolatom proteina sirutke markeri oksidacijskog stresa MDA i 4-hidroksialkeni su bili 40% niži u homogenatima mozga, a proizvodnja vodikovog peroksida i superoksida bila je 25-35% manja u mitohondrijima mozga. Ovi rezultati ukazuju na to da se primjenom izolata proteina sirutke povećao broj ili poboljšale funkcije mitohondrija mozga. Autori zaključuju da primjena izolata proteina sirutke smanjuje oksidacijski stres i povećava mitohondrijsku aktivnost u mozgu miša. Izolati proteina sirutke kao dodaci prehrani mogu biti korisni u liječenju stanja povezanog sa oksidacijskim stresom ili smanjene mitohondrijske aktivnosti u mozgu (Shertzer i sur., 2013.).

Nardi i suradnici istraživali su i uspoređivali protuupalno i antioksidacijsko djelovanje goji bobica, borovnice i brusnice na miševima. Miševi su tretirani 10 dana s 50 i 200 mg kg⁻¹ ekstrakta. Antioksidacijsku aktivnost odredili su ispitivanjem koncentracije GSH i katalaze. U sve tri biljke zabilježena je veća količina fenolnih spojeva (uključujući i rutin). Količina GSH i CAT bila je najveća u skupini koja je dobivala goji bobice, a najniže u skupini koja je dobivala borovnice. Autori su donijeli dva zaključka: bobičasto voće ima protuupalno i antioksidacijsko djelovanje, te da goji bobice, borovnica i brusnica moduliraju upalne procese na različite načine (Nardi i sur; 2016.). Gu i suradnici su proveli studiju kako bi se procijenili učinci visoko-proteinske dijeta na ravnotežu proizvodnje slobodnih radikala i antioksidacijskog statusa u probavnim organima C57BL6 miša. Miševi su podijeljeni u dvije skupine: skupina koja je imala normalni unos proteina (20%) te druga skupina s visokim unosom proteina (60%), uz dodatak 0,06g/kg cisteina. Nakon dva

tjedna, miševima su izmjereni oksidacijski i antioksidacijski parametri u dvanaesniku, jetri i gušterači. Rezultati pokazuju kako se konzumacijom visoko-proteinske prehrane značajno povećala koncentracija MDA i superoksidnog aniona, smanjila aktivnost SOD, glutation peroksidaze i katalaze te smanjio sadržaj reduciranog glutationa (GSH). U skupini hranjenoj visoko-proteinskom dijetom uz dodatak cisteina je pojava oksidacijskog stresa ublažena. Rezultati studije pokazuju da konzumacija visoko-proteinske dijetete može dovesti do promjene oksidacijsko/antioksidacijske ravnoteže i tako izazvati oksidacijski stres u probavnim organima miševa (Gu i sur., 2008).

Proteini sirutke sporedni su proizvod pri proizvodnji sira i za sada su nedovoljno iskorišteni u ljudskoj prehrani. Usljed svoje iznimne nutritivne vrijednosti (velikog udjela esencijalnih aminokiselina, aminokiselina koje sadrže sumpor te aminokiselina razgranatog lanca) i poželjnih funkcionalnih svojstava, proteini sirutke se sve više koriste u proizvodnji različitih, tradicionalno pripremljenih proizvoda, ali i novostvorenih prehrambenih proizvoda. Kako imaju aminokiselinski sastav blizu biološkog optimuma, smatraju se nutritivno najvrjednijim proteinima stoga ne iznenađuje porast interesa i provedenih istraživanja o djelovanju proteina sirutke.

U ovom istraživanju promatrao se učinak polifenola iz ekstrakta cvijeta trnine i visoko-proteinske dijetete u homogenatu tkiva bubrega i jetre. Trnina je biljka s visokim antioksidacijskim kapacitetom zbog visokog sadržaja feonlnih spojeva. Whey protein (WP) korišten u ovom istraživanju je koncentrat proteina sirutke koji sadrži 82% proteina u suhoj tvari. Proteini sirutke imaju visok udio aminokiselina razgranatog lanca. Prednost Whey proteina u odnosu na druge proteine je u tome što se brzo apsorpira u crijevima. Antioksidacijsko djelovanje WP bazirano je na visokom sadržaju i bioiskoristljivosti aminokiseline cistein koja pomaže u sintezi glutationa (GSH), moćnog unutarstaničnog antioksidansa. Koncentracije GSH izražene preko aktivnosti reduciranog glutationa (GSH) u bubregu i jetri statistički su značajno povećane u svim grupama u odnosu na kontrolnu grupu životinja (slike 3 i 4), što kazuje na antioksidacijski učinak ne samo ekstrakta cvijeta trnine nego i Whey proteina.

Zaključci

Rezultati ovog istraživanja pokazuju da je tretman s ECT statistički značajno (ANOVA, $p < 0,05$) smanjio aktivnosti MDA u jetri i bubregu miša u odnosu na kontrolnu skupinu životinja što se može pripisati polifenolima prisutnim u ekstraktu cvijeta trnine, dok su ostale grupe ostale na razini kontrolne skupine. Koncentracija GSH u ispitivanim uzorcima jetre i bubrega statistički su značajno (ANOVA, $p < 0,05$) povećane u svim grupama miševa u odnosu na kontrolnu grupu, što kazuje na antioksidacijski učinak bioaktivnim spojevima u ekstraktu cvijeta trnine kao i whey proteina i smanjenje oksidacijskog stresa. Promatrani promjenjivi učinci eksperimentalnih dijeta na aktivnosti enzima pokazuju da antioksidansi uključeni u obranu od ROS-a u bubregu i jetri uvelike ovise o enzimima, porijeklu oksidacijskog stresa i izvoru antioksidansa. Da bi se u potpunosti razumjele fiziološke implikacije kao odgovor na oksidacijski stres, potrebna su dublja znanja o mehanizmima koji reguliraju aktivnosti ovih enzima.

Zahvala: Ovo istraživanje financirano je sredstvima znanstvenog projekta Hrvatske zaklade za znanost – HRZZ (2014.-2018.), "Primjena inovativnih tehnologija u proizvodnji biljnih ekstrakata kao sastojaka funkcionalne hrane (IP-PE-FF).

Literatura

- Bukan N., Sancak B., Yavuz O., Koca C., Tutken F., Ozcelikay A.T., Altan N. (2003): Lipid peroxidation and scavening enzyme levels in the liver of streptozotocin-induced diabetic rats, *Indian. J. Biochem. Biophys.* 40, 447-450.
- Burd N.A., Yang Y., Moore D.R., Tang J.E., Tarnopolsky M.A., Phillips S.M. (2012): Greater stimulation of myofibrillar protein synthesis with ingestion of whey protein isolate v. micellar casein at rest and after resistance exercise in elderly men, *Br. J. Nutr.* 108, 958–962.
- Diamanti, J., Mezzetti, B., Giampieri, F., Alvarez-Suarez, J.M., Quiles, J.L., Gonzalez-Alonso, A., Ramirez-Tortosa, M.C., Grandos-Principal, S., Gonzales, A.M., Santos-Buelga, C., Battino, M. (2014): Doxorubicin-induced oxidative stress in rats is efficiently counteracted by dietary anthocyanin differently enriched strawberry, *J. Agric. Food. Chem.* 62, 3935-3943.
- Eyer, P., Worek, F., Kiderlen, D., Sinko, G., Stuglin, A. (2003): Molar absorption coefficients for the reduced Ellman reagent: reassessment, *Anal. Biochem.* 312, 224–227.
- Gago-Dominguez M., Castela J.E. (2006): Lipid peroxidation and renal cell carcinoma: further supportive evidence and new mechanistic insights, *Free. Radic. Biol. Med.* 40, 721-733.
- Grabacka M., Reiss K. (2008): Anticancer Properties of PPAR alpha-Effects on Cellular Metabolism and Inflammation, *PPAR Res.* 28, 1-9.
- Gu, C., Shi, Y., Le, G. (2008): Effect of dietary protein level and origin on the redox status in the digestive tract of mice, *Int. J. Mol. Sci.* 9, 464-475.
- Hesham, A.E., Ezzedin, S.E., Somaia, A.N., Mohamed, F.E., Enayat, A.O., Naglaa, A. (2014): Evaluation of the therapeutic effect of whey proteins on the hepatotoxicity induced by paracetamol and alcohol co-administration in rats, *IJPRBS.* 3, 295-314.
- Ho, V.W., Leung, K., Hsu, A., Luk, B., Lai, J., Shen, S.Y., Minchinton, A.I., Waterhouse, D., Bally, M.B., Lin, W., Nelson, B.H., Sly, L.M., Krystal, G. (2011): A low carbohydrate, high protein diet slows tumor growth and prevents cancer initiation, *Cancer. Res.* 71(13), 4484-4493.
- Jayakumar, T., Sakthivel, M., Thomas, P.A., Geraldine, P. (2008): Pleurotus ostreatus, an oyster mushroom, decreases the oxidative stress induced by carbon tetrachloride in rat kidneys, heart and brain, *Chem. Biol. Interact.* 176, 108-120.
- Journel, M., Chaumontet, C., Darcel, N., Fromentin, G., Daniel Tomé, D. (2012): Brain Responses to High-Protein Diets, *Adv. Nutr.* 3, 322–329.
- Kinsey-Jones, J.S., Alamshah, A., McGavigan, A.K., Spreckley, E., Banks, K., Monteoliva, N.C., Norton, M., Bewick G.A., Murphy, K.G. (2015): GPRC6A is not Required for the Effects of a High-Protein Diet on Body Weight in Mice, *Obesity.* 23, 1194–1200.
- Lowry, D.H., Rosebrough, N.J., Farr A.L. (1951) Protein measurement with the Folin– phenol reagent, *J. Biol. Chem.* 193, 265–275.
- Mansour, D.F.S., Eldenshary, E.S., Nada, S.A., Omara, E.A., Ibrahim, M.I.M. (2013): Therapeutic effectiveness of certain whey proteins on lipopolysaccharide-induced oxidative stress and histopathological changes in rat liver, *J. Appl. Sci. Res.* 9, 4983-4992.
- Marshall K. (2004) Therapeutic applications of whey protein, *Altern. Med. Rev.* 9, 136–156.

- Mateos R., Goya L., Bravo L. (2005): Determination of malondialdehyde (MDA) by high-performance liquid chromatography in serum and liver as a biomarker for oxidative stress. Application to a rat model for hypercholesterolemia and evaluation of the effect of diets rich in phenolic antioxidants from fruits, *J. Chrom. B.* 827, 76–82.
- Nada, S., El-Denshary, E.S., Omara, E.A., Asaad, G.F., Abdel-Rahman, R.F. (2015): Milk whey proteins modulate endotoxemia-induced hepatotoxicity in rats, *Int. J. Pharm. Pharmac.Sci.* 7, 64-71.
- Nardi, G.M., Farias- Januario, A.G., Freire, C.G., Megiolaro, F., Schneider, K., Perazzoli, M.R., Do-Nascimento, S.R., Gon, A.C., Mariano, L.N., Wagner, G., Niero, R., Locatelli, C. (2016): Anti-inflammatory Activity of Berry Fruits in Mice Model of Inflammation is Based on Oxidative Stress Modulation, *Pharmacognosy Res.* 8, 42-49.
- Pandey, K.B., Rizvi, S.I. (2009) Plant polyphenols as dietary antioxidants in human health and disease, *Oxid. Med. Cell. Longev.* 2, 270-278.
- Petlevski, R., Juretić, D., Hadžija, M., Slijepčević, M., Lukač-Bajalo, J. (2006): Koncentracija malondialdehida u NOD miševa tretiranih akarbozom, *Biochem. Med.* 16, 43-49.
- Pilaczynska-Szczesniak, L., Skarpanska-Steinborn, A., Deskur, E., Basta, P., HoroszkiewiczHassan, M. (2005): The influence of chokeberry juice supplementation on the reduction of oxidative stress resulting from an incremental rowing ergometer exercise, *Int. J. Sport Nutr. Exerc. Metab.* 15, 48-58.
- Petzke, K.J., Elsner, A., Proll, J., Thielecke, F., Metges, C.C. (2000): Long-term high protein intake does not increase oxidative stress in rats, *J. Nutr.* 130; 2889–2896
- Santesso, N., Aki, E.A., Bianchi, M., (2012): Effects of higher- versus lower- protein diets on health outcomes: a systematic review and meta-analysis, *Eur. J. Clin. Nutr.* 66,780-788.
- Scalbert, A., Manach, C., Morand, C., Remesy, C., Jimenez, L. (2005): Dietary polyphenols and the prevention of diseases, *Crit. Rev. Food. Sci. Nutr.* 45, 287–306.
- Shertzer, H.G., Krishan, M., Genter, M.B. (2013): Dietary whey protein stimulates mitochondrial activity and decreases oxidative stress in mouse female brain, *Neurosci. Lett.* 548, 159–164.
- Slatter D.A., Bolton C.H., Bailey A.J. (2000): The importance of lipid-derived malondialdehyde in diabetes mellitus, *Diabetologia.* 43, 550-557.
- Sousa, G.T.D., Lira, F.S., Rosa, J.C., Oliveira, E.P., Oyama, L.M., Santos, R.V., Pimentel, G.D. (2012): Dietary whey protein lessens several risk factors for metabolic diseases: a review, *Lipids. Health. Dis.* 11, 1-9.
- Tiku M.L., Allison G.T., Naik K., Karry S.K. (2003): Malondialdehyde oxidation of cartilage collagen by chondrocytes, *Osteoarthritis. Cart.* 11, 159-166.
- Valko, M., Rhodes, C. J., Moncol, J., Izakovic, M., Mazur, M. (2006) Free radicals, metals and antioxidants in oxidative stress-induced cancer, *Chem. Biol. Interact.* 160, 1–40.

Original research paper

Effect of Flavonoids from flowers of *Prunus spinosa* L. and Whey protein to oxidation/ antioxidant status in the C57BL/6 mouse

Irena Landeka Jurčević^{1*}, Domagoj Đikić², Vedran Bolta², Ivona Paradžik¹, Lea Sabljic¹

¹*University of Zagreb, Faculty of Food Technology and Biotechnology Zagreb,
Pierottijeva 6, 10 000 Zagreb, Croatia*

²*University of Zagreb, Faculty of Science Zagreb, Rooseveltov trg 6, 10 000 Zagreb, Croatia*

**Corresponding author: ilandeka@pbf.hr*

Summary

This study was conducted to evaluate the effects of high-protein diets and flavonoids isolated from the flowers of *Prunus spinosa* L. on various markers of oxidative stress in the liver and kidney of a mouse. Under normal physiological conditions the cell system is able to neutralize free radicals through catalytic removal of reactive oxygen species (ROS) with antioxidant enzymes. Antioxidant activity of the whey protein (WP) is based on the high content and bioavailability of the amino acid cysteine, which helps in the synthesis of glutathione (GSH), a potent intracellular antioxidant. The effect of WP and flavonoids isolated from the flower trnina (ECT) has been investigated in laboratory animals (C57BL/6 mouse) through 30 days of treatment. The animals were divided into 4 groups: group I - control group (KO); group II – flower extract trnina (ECT); group III – Whey protein (WP) and group IV - WP + ECT. The investigated biomarkers of oxidative stress in the organs were malondialdehyde (MDA) and reduced glutathione (GSH). The results show that a treatment with ECT significantly reduced the activity of MDA in the organs of mice compared to the control group, while the other group remained at the level of the control group. The concentrations of reduced glutathione (GSH) in the examined organs were statistically significantly increased in all groups compared to the control group. These results indicate that the extract of a flower trnina and whey proteins may act as a nutritional ingredient to increase endogenous antioxidant enzymes and reduce oxidative stress.

Keywords: Prunus spinosa L., Whey protein, lipid peroxidation, reduced glutathione

Izvorni znanstveni rad

Biodostupnost antocijana iz pokožice crnog grožđa u serumu C57BL/6 miša

Irena Landeka Jurčević^{*}, Monika Fumić¹, Domagoj Đikić², Verica Dragović-Uzelac¹,
Sandra Pedisić¹, Zoran Zorić¹

¹Sveučilište u Zagrebu, Prehrambeno-biotehnološki fakultet Zagreb,
Pierottijeva 6, 10 000 Zagreb, Hrvatska

²Sveučilište u Zagrebu, Prirodoslovno-matematički fakultet Zagreb,
Rooseveltoveg trg 6, 10 000 Zagreb, Hrvatska

^{*}Dopisni autor: ilandeka@pbf.hr

Sažetak

Cilj ovog rada bio je ispitati biodostupnost antocijana iz pokožice crnog grožđa u serumu miša. Antocijani su podskupina flavonoida i prirodni biljni pigmenti odgovorni za različite nijanse crvene, ljubičaste i plave boje grožđa. Sudbina antocijana nakon oralne primjene slijedi jedinstveni put koji se razlikuje od drugih flavonoida. Razlike u apsorpciji različitih tipova antocijanina upućuju da apsorpcija ovisi o kemijskoj strukturi i tipu konjugacije antocijanina. Teško je odrediti biodostupnost antocijanina zbog suplemenata koji sadrže nekoliko strukturno različitih antocijanina te zbog reakcija koje omogućuju pretvorbu cijanidina u peonidine, delfinidina u petunidine i petunidine u malvidine. Ova studija je provedena na animalnom modelu C57BL/6 miša koji su tretirani sa ekstraktom pokožice grožđa (GSE). Broj grupa: serumi su prikupljeni nakon 15, 30, 60, 120, 180 i 240 min, te analizirani na UPLC-MS (tekućinska kromatografija visoke djelotvornosti uz MS/MS detekciju). Glavni metaboliti u serumu su bili: Malvidin-3-glukozid (Mal-3-Glc), Peonidin-3-glukozid (Peo-3-Glc) i Cijanidin-3-glukozid (Cy-3-Glc). Maksimalne razine antocijanidin-glukozida u serumu su izmjerene 60 min nakon tretiranja životinja, i to 63,092; 7,455 i 124,061 ng/mL. Rezultati pokazuju da antocijani iz pročišćenog ekstrakta pokožice grožđa poboljšavaju ukupan antioksidacijski kapacitet seruma.

Ključne riječi: biodostupnost, pokožica grožđa, UPLC MS/MS, antocijani

Uvod

Povećanje svijesti potrošača o prehrani u svezi zdravstvenih problema, te rastuće nepovjerenje prema umjetnim aditivima osnovni su pokretači koji potiču znanstvenu zajednicu, kao i prehrambenu industriju da krenu u potragu za prirodnim prehrambenim aditivima koji bi zamijenili umjetne, potencijalno štetne po zdravlje.

Na pokožicu grožđa otpada najveći postotak vinskog otpada, odnosno komine. Komina su fermentirani ili nefermentirani ostaci koji zaostaju nakon prešanja svježeg grožđa. Pokožica grožđa i sjemenke su posebno bogat izvor polifenola poput proantocijanidina, antocijanina, flavonola i flavan-3-ola koji posjeduju antibakterijska, antivirusna, antioksidacijska, protuupalna, anti-kancerogena i kardioprotektivna svojstva (Kallithraka i sur, 2005).

Medicinska kemija i farmacija / *Medical Chemistry and Pharmacy*

Agro-industrijski otpad od voća i povrća sadrži značajni dio vrijednih spojeva (Das, 2001) čija je dostupnost, ekstrakcija i antioksidacijski kapacitet predmet znanstvenih istraživanja (Moure i sur., 2001). Antocijani su pigmenti topljivi u vodi, pripadaju podskupini flavonoida te su odgovorni za plavu, ljubičastu, narančastu i crvenu boju raznog voća, cvijetova i lišća. Kod većine sorti, pokožica je jedino mjesto gdje se nalaze tvari boje. Antocijani su sakupljeni u pokožici i zauzimaju 3 – 4 sloja stanica ispod epiderme. Na njihovu stabilnost utječu brojni čimbenici poput pH, temperature, svjetla, prisutnosti drugih fenolnih spojeva, enzima, iona metala, šećera, askorbinske kiseline, kisika i sumporova dioksida (Ovando i sur., 2009). Unatoč njihovoj slabijoj oralnoj biodostupnosti te relativno niskoj postprandijalnoj koncentraciji u plazmi, konzumacija namirnica bogatih ovim pigmentima usko je povezana sa smanjenim rizikom od nastanka nekoliko patoloških stanja, uključujući razvoj kardiovaskularnih bolesti (Jennings i sur., 2012) i karcinoma (Zamora-Ros i sur., 2012). Antocijani su u grožđu smješteni u pokožici, te su odgovorni za njegovu crnu boju (Di Lecce i sur., 2014).

Antocijanidini su osnova strukture antocijana. To su aglikonski djelovi na koje se mogu vezati šećeri ili organske kiseline. U sastavu grožđa, vina i komine prema broju i vrsti supstituiranih hidroksilnih i metilnih skupina razlikujemo 5 antocijanidina: delfinidin, cijanidin, peonidin, petunidin i malvidin. Relativno su nestabilni i lako oksidiraju. Pri nižim pH vrijednostima nalaze se u formi flavijevog kationa, dok su pri višim pH vrijednostima u kinoidalnoj formi (Garrido i Borgez, 2013). Biodostupnost ovih spojeva je relativno niska zbog slabe apsorpcije u probavnom sustavu te ovisi o vrsti spoja, kemijskoj strukturi, opsegu konjugacije te individualnosti crijevne mikrobiote (Shivashankara i Acharya, 2010). Ipak antocijani dijele zajedničke metaboličke reakcije sa ostalim flavonoidima. Antocijani su kao i flavonoidi prisutni u hrani uglavnom kao glikozidi. Aglikonski dio je hidrofoban i lako prolazi kroz membrane pasivnom difuzijom. Difuzija hidrofobnog dijela antocijana se ne odvija lako kroz membrane. Apsorpcija antocijana se odigrava aktivnim transportom tako što prvo dolazi do hidrolize. Mnoge kliničke studije ukazuju na to da se resorpcija antocijana odvija u malom intestinumu, mada još uvijek do kraja nije razjašnjeno kako ulaze u enterocyte. Pretpostavlja se da se to odvija natrij-glikozidnim transportom ili pasivnom difuzijom aglikona koji se prije prolaska kroz membranu izdvojio iz glikozida poslije hidrolize laktat pilorizin hidrolazom (Wrolstad, 2004).

Antocijane karakterizira kompleksnost u ispoljavanju njihovog kemijskog utjecaja *in vitro* te *in vivo* (McGhie i Walton, 2007), posebice kada je riječ o njihovoj apsorpciji, metabolizmu, distribuciji te ekskreciji (Cisowska i sur., 2011), što znatno utječe na stupanj njihovog povoljnog učinka na zdravlje. Slično drugim polifenolima, antocijani se hidroliziraju u crijevima, te se brzo apsorbiraju u probavnom traktu gdje ulaze u epitelne stanice pasivnom difuzijom ili pomoću specifičnih proteina nosača (Crozier i sur., 2009).

Antocijani se mogu apsorbirati netaknuti, bez obzira na razlike u veličini ili pak šećernim i aciliranim skupinama koje sadrže (Stalmach i sur., 2012). Na brzinu i stupanj apsorpcije antocijana utječu supstituenti, odnosno glikonski i šećerni dio te acilirane skupine (Tian i sur., 2006). Stupanj apsorpcije može biti smanjen ukoliko se antocijani nalaze u formi kompleksa sa drugim spojevima (Kurilich i sur., 2005). Nakon apsorpcije, antocijani se dalje metaboliziraju u enterocitima ili se izlučuju iz organizma putem urina i žuči ovisno o kemijskoj strukturi (Ichiyonagi i sur., 2006). Kada dospiju u krvotok, metaboliti antocijana mogu biti podvrgnuti drugoj fazi metabolizma koja uključuje daljnje pretvorbe u jetri. Te pretvorbe su posredovane tzv. detoksikacijskim enzimima

jetre, koji su također locirani u crijevnom epitelu te bubrezima. Putem tih metaboličkih pretvorba, antocijani podliježu biotransformacijama koje uključuju metilaciju, glukuronidizaciju i/ili sulfataciju što narušava njihovu strukturnu stabilnost (Galvano i sur., 2009). Antocijani dosežu maksimalnu koncentraciju u cirkulaciji tijekom 3h od unosa. Brza stopa apsorpcije uglavnom je vezana uz apsorpciju u želucu (Passamonti i sur., 2003). Nadalje, antocijani se brzo uklanjaju iz plazme jetrenim metabolizmom (Milbury i sur., 2002), a općenita biodostupnost je <2% (Ichiyanagi i sur., 2006).

Cilj ovog rada bio je odrediti biodostupnost antocijana izoliranih iz pokožice grožđa u serumu C57BL/6 miša.

Materijali i metode

Pokusne životinje

Pokusni su provedeni na životinjama iz jedinice za uzgoj laboratorijskih životinja Prirodoslovno-matematičkog fakulteta, Sveučilišta u Zagrebu. Pokusne životinje bile su C57BL/6 miševi, u dobi od tri mjeseca. Održavanje i njega svih pokusnih životinja provedena je u skladu sa smjernicama koje su na snazi u Republici Hrvatskoj (Zakon o dobrobiti životinja, NN #135, 2006 i Pravilnikom o zaštiti životinja koje se koriste u pokusima ili druge znanstvene svrhe, NN #47, 2011), a provodi se u skladu s Uputama za njegu i korištenja laboratorijskih životinja, DHHS Publ. #(NIH) 86-123. Pokus je odobrilo Etičko povjerenstvo Prirodoslovno-matematičkog fakulteta, Sveučilišta u Zagrebu (No. 251-58-10617-14-37). Po šest životinja je bilo smješteno u kavezu. Životinje su intragastričnom sondom tretirane sa 0,2 mL fiziološke otopine - kontrolna grupa (KO); odnosno 0,2 mL (100 mg/kg/dan) ekstrakta pokožice grožđa (GSE). Životinje su anestetizirane eterom te su iskrvarene punkcijom iz srca bez antikoagulansa nakon 15 min., 30 min., 1 h, 2 h, 3h i 4 h. Uzorci seruma su potom pohranjeni na -80°C za daljnju analizu.

Priprema uzoraka seruma za enzimsku hidrolizu

Krv je centrifugirana na 2000 g kroz 10 minuta na +4°C. Nakon centrifugiranja krvi, odvojen je serum koji je pomiješan sa 1/10-om volumena otopine - 20% askorbinska kiselina i 0.05% Na₂EDTA otopljena u 0.4 M fosfatnom puferu (finalni pH 6,5), te je pohranjen na -80°C.

Enzimski hidroliza uzoraka i ekstrakcija

Metabolizam antocijana uključuje metilaciju, sulfataciju i konjugaciju sa glukuronskom kiselinom te degradaciju glikozidnih kompleksa i heterocikličkih oblika antocijana. Za navedene pretvorbe potrebno je djelovanje enzima β-D-glukozidaze, β-D-glukuronidaze i sulfataze koji su odgovorni za otpuštanje aglikona iz glikozidnih ili glukuronidnih oblika.

200 μL seruma se pomiješa sa 10 μL mix enzima (250 U β-glukuronidase i 20 U sulfataze). Potom se enzimski hidroliza provede tako što se smjesa uzoraka i enzima inkubira 45 minuta na 37°C. Nakon inkubacije uzorci su dva puta ekstrahirani sa etil-acetatom te centrifugirani 5 min/12000 rpm /+4°C. Nakon ekstrakcije u supernatant se doda etil acetat koji sadrži 10 μL 20% askorbinske kiseline i uzorci se upare do suha (vacuum centrifuge concentrator - 30°C, 40 min). Nakon uparavanja talozi se otople u 100 μL 10% vodene otopine acetonitrila te centrifugiraju 5 min/16000 rpm pri sobnoj temperaturi.

Medicinska kemija i farmacija / *Medical Chemistry and Pharmacy*

UPLC MS/MS (Ultra Performance Liquid Chromatography - tandem mass spectrometer) analiza ekstrakta pokožice grožđa

Ispitane su različite metode i uvjeti određivanja bioaktivnih spojeva (BAS) u uzorcima seruma i organa te je provedena validacija metode i izračeni su baždarni pravci (Serra i sur., 2011). Antocijani u ekstraktima dobivenih iz bioloških uzoraka analizirani su UPLC-MS/MS metodom (Trostruki kvadropol, 6430, Agilent, USA) opremljenim sučeljem za elektrosprej ionizaciju (ESI). Za desolvataciju i u kolizijskoj ćeliji koristio se dušik. Maseni spektrometar je spojen na sustav za tekućinsku kromatografiju (serija 1290 Infinity, Agilent, USA). Sustav se sastoji od visokotlačne binarne pumpe, automatskog injektora, odzračivača i termostata za kolonu. Kolona za razdvajanje komponenata je Zorbax C18 100×2.1×1.8 (Agilent, USA). Antocijani se razdvajaju s mobilnim fazama koje sadrže 10% HAc u H₂O (A) i ACN (B). Antocijani se analiziraju u pozitivnom ionskom modu pri slijedećim uvjetima: protok plina: 11 L/min, temperatura: 300 °C, nebulizer: 400 psi, voltaža na kapilari: ± 4000 V. Na temelju masenih spektara provedena je identifikacija, a na temelju jednadžbi baždarnih pravaca kvantifikacija antocijana u uzorcima provedenih *in vivo* istraživanjima (Serra i sur., 2011).

Statistička analiza

Statistička obrada rezultata provedena je pomoću programa *Statistica v. 10.* software (StatSoft Inc. Tulsa, USA). Dobivene podatke smo izražavali u obliku srednja vrijednost ± standardna devijacija srednje vrijednosti. Višestruku usporedbu kontrolne i tretiranih skupina miševa izvršili smo ANOVA analizom varijance. Interval pouzdanosti namjestili smo na $p \leq 0,05$.

Rezultati i rasprava

Nakon jedne intragastrične aplikacije antocijanidini su detektirani u serumu nakon 15 minuta i dostigli su maksimalnu koncentraciju od 63,092 ng/mL za Mal-3-Glc; 68,111 ng/mL za Cy-3-Glc i 7,455 ng/mL za Peo-3-Glc 1 h nakon intragastrične aplikacije. Koncentracija antocijana u serumu je naglo opala 2 h nakon aplikacije (Slika 1 a, b i c). Antocijani su zajedno sa ostalim flavonoidima važni nutritivni sastojci zbog svojih antioksidacijskih sposobnosti, što ukazuje na njihovu potencijalnu primjenu u prevenciji bolesti koje su povezane sa oksidacijskim stresom (Croiser i sur., 2010.). Dnevna potrošnja antocijana je procijenjena na 3-215 mg/dan (Chun i sur., 2007). Prema Europskoj agenciji za sigurnost hrane, siguran unos hranom je 36 mg antocijana dnevno.

Biodostupnost fenolnih komponenata je ovisna o strukturi hrane u kojoj su prisutni. Lipofilnija struktura može ubrzati topljivost i apsorpciju flavonoida. Prisutnost etanola može utjecati na stupanj apsorpcije antocijana (Faria i sur., 2009) te njihov transport kroz epitel crijeva. Sljedeći faktor koji je potrebno uzeti u obzir kada je riječ o biodostupnosti antocijana je interakcija između polifenolnih komponenata i ostalih komponenata prisutnih u hrani (polifenolne komponente imaju sposobnost interakcije sa proteinima prisutnim u hrani) (Jakobek, 2015). Te interakcije mogu imati utjecaja na modifikaciju njihove biološke funkcije i ograničenje apsorpcije. Ustanovljeno je kako stanice postaju sklonije transportu antocijana kada su dugotrajnije izložene njihovom unosu. Još jedan važan faktor koji može imati utjecaja na biodostupnost antocijana je njihovo potencijalno uzimanje kao pigmenta (derivati antocijana), posebice kada je riječ o konzumaciji vina. Antocijani mogu dospjeti u plazmu štakora 15 minuta nakon oralne primjene 400 mg/kg (~21.1 nM kg/μmol malvidin-3-glukozid piruvinske kiseline i ~28.8 nM kg/μmol, malvidin-3-glukozida) (Faria i sur., 2009).

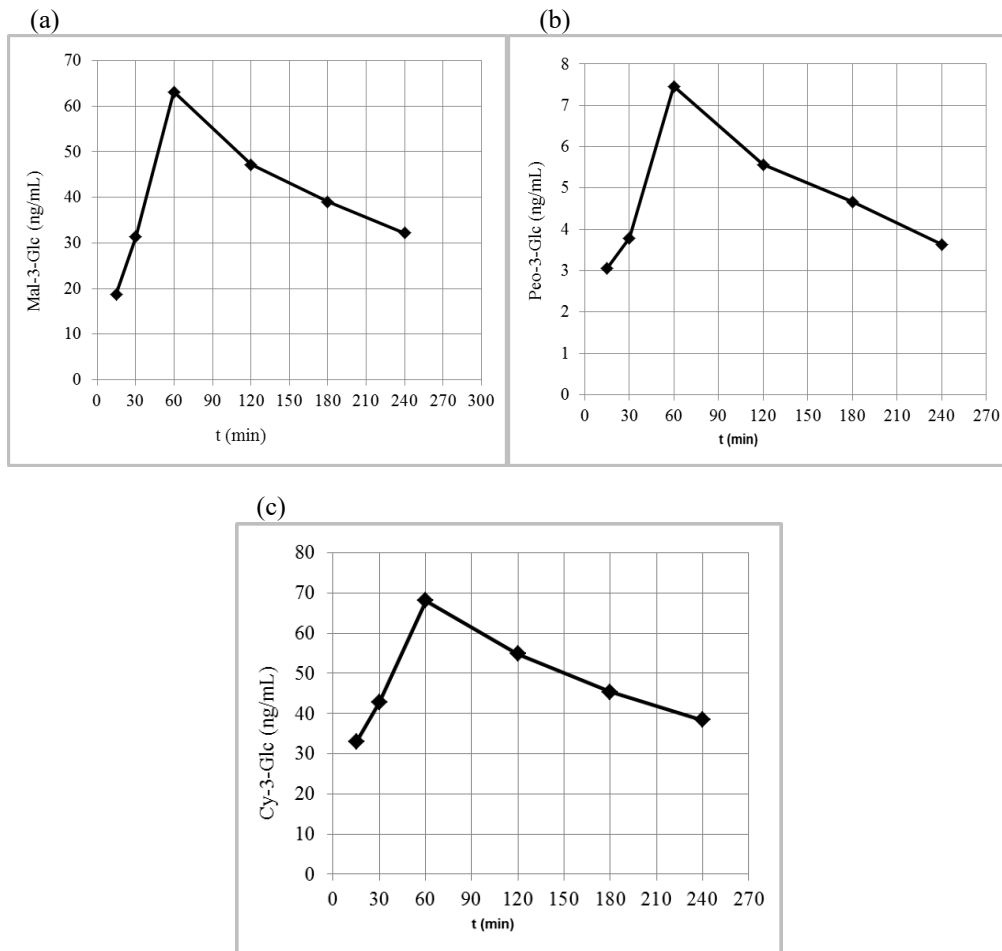

Slika 1. Srednja vrijednost koncentracija Mal-3-Glc (a), Peo-3-Glc (b) i Cy-3-Glc (c) u ovisnosti o vremenu u serumu C57BL/6 miša nakon intragastrične aplikacije ekstrakta pokožice grožđa u dozi od 100 mg/kg tjelesne težine.

Kratice: Mal-3-Glc (malvidin-3-glukozid), Peo-3-Glc (peonidin-3-glukozid) i Cy-3-Glc (cijanidin-3-glukozid)

Fig. 1. The mean concentration of Mal-3-Glc (a), Peo-3-Glc (b) and Cy-3-Glc (c) in function of time in the serum of C57BL/6 mouse after intragastric administration of the extract of grape berry skin at a dose of 100 mg/kg body weight.

Abbreviation: Mal-3-Glc (malvidin-3- glucoside), Peo-3-Glc (peonidin-3- glucoside) i Cy-3-Glc (cyanidin-3-glucoside)

Medicinska kemija i farmacija / Medical Chemistry and Pharmacy

Nakon gutanja, antocijanini se brzo detektiraju u plazmi u nativnim oblicima, vjerojatno kao rezultat njihove apsorpcije kroz želučanu stjenku (Milbury i sur., 2002). Ispitivanje biodostupnosti koje je provedeno na štakorima koji su bili tretirani sa 400 mg/kg antocijana pokazalo je da su poslije jedne oralne aplikacije antocijani detektirani u plazmi nakon 15 minuta i da su dostigli maksimalnu koncentraciju od 2-3 µg/mL nakon 1,5 h, te da je koncentracija antocijana naglo opala nakon 2 h (Manach i sur., 2005). Maksimalna koncentracija antocijana u plazmi se postiže unutar 0,5-2 h nakon konzumacije hrane bogate antocijanima. Sustavna biodostupnost antocijana se procjenjuje na otprilike 0,26-1,8% u studijama provedenim na životinjama (Borges i sur., 2007). Maksimalna koncentracija ukupnih antocijana u plazmi iznosi 1-100 nmol/L nakon konzumacije bobičastog voća i grožđa kod zdravih pojedinaca (Prior i Wu, 2006). Apsorbirani antocijani se brzo eliminiraju iz sistemske cirkulacije. U pokožici grožđa najviše su zastupljeni malvidin-3-glukozid te cijanidin-3-glukozid. U studijama koje su se bavile proučavanjem farmakokinetike malvidina i cijanidina je ustanovljeno kako malvidin-3-glukozid i cijanidin-3-glukozid dosežu maksimalnu koncentraciju u plazmi 30-60 min nakon obroka (Vitaglione i sur., 2007). S obzirom na biodostupnost, cijanidin-3-glukozid te pelargonidin-3-glukozid imaju najviši stupanj sistemske biodostupnosti.

Naši rezultati se slažu sa gore navedenim rezultatima ako se uzme u obzir da su životinje tretirane sa 100 mg/kg ekstrakta pokožice grožđa. Antocijani groždanog soka imaju viši stupanj apsorpcije u odnosu na antocijane vina, što je potvrđeno na zdravim pojedincima. Razlog tomu je viši sadržaj šećera u groždanom soku. Antocijani su u uzorcima plazme i urina bili uglavnom prisutni u formi glukozida. Nakon unosa groždanog soka, maksimalna koncentracija Cy-3-Glc je iznosila 0,42 ng/mL, Mal-3-Glc 48,8 ng/mL te Peo-3-Glc 27,3 ng/mL kroz 30 minuta. Nakon unosa crvenog vina nije detektirana prisutnost Cy-3-Glc, dok je maksimalna koncentracija Mal-3-Glc iznosila 18,5 ng/mL, a Peo-3-Glc 12,6 ng/mL kroz 90 minuta. Nije utvrđena statistički značajna razlika u koncentraciji ukupnih antocijana prisutnih u plazmi nakon unosa oba pića. Jedina razlika je utvrđena za koncentraciju cijanidina i delfinidina koja je bila veća u slučaju unosa groždanog soka (Bitsch i sur., 2004). Otprilike 30-44% konzumiranog Cy-3-Glc je pronađeno u ljudskoj plazmi u obliku protokatehinske kiseline (PCA) nakon konzumacije soka od naranče (Vitaglione i sur., 2007) te kupina (Chen i sur., 2012). Maksimalna koncentracija PCA je iznosila 0,5 µM nakon uzimanja 71 mg Cy-3-Glc u zdravih pojedinaca, a Cy-3-Glc 1,9 nM (Vitaglione i sur., 2007).

3'-O-metilacija je odgovorna za pretvorbu cijanidina u peonidin te delfinidina u petunidin, dok 5'-O-metilacijom petunidin prelazi u malvidin (Crozier i sur., 2009). Kateholna struktura je od presudne važnosti za aktivnost katehol-O-metiltransferaze (COMT; enzim koji sudjeluje u degradaciji neurotransmitera) te zbog toga pelargonidin, peonidin, i malvidin nemaju metilirane metabolite. Tragovi petunidin-3-glukozida i malvidin-3-glukozida, nastali metilacijom delfinidin-3-glukozida (metabolita koji nastaje nakon ingestije cijanidin-3-glukozida), nađeni su u bubrezima, jetri, serumu te urinu štakora (Vanzo i sur., 2011). U urinu čovjeka i štakora, koncentracija delfinidina je niža u odnosu na koncentraciju malvidina. Razlog tome je razlika u hidrofobnosti; malvidin ima manje slobodnih hidroksilnih skupina što ga čini hidrofobnijim, pa se lakše transportira u stanice i tkiva. Budući da je ekskrecija putem urina indikator apsorpcije, u istraživanju provedenom na štakorima, utvrđeno je da delfinidin glukozid ima viši stupanj apsorpcije u odnosu na malvidin glukozid (McGhie i sur., 2003). Ovo saznanje također podupire činjenica da je koncentracija delfinidina i cijanidina u plazmi znatno viša u odnosu na koncentraciju malvidina.

Rezultati istraživanja provedenih na antocijanima upućuju na njihovu slabu biodostupnost (Pojer i sur., 2013). Postoji nekoliko faktora koji su odgovorni za relativno nisku biodostupnost antocijana, uključujući i činjenicu da je značajan broj njihovih metabolita prisutan u koncentracijama koje se ne mogu analitički detektirati. Također, određene forme antocijana se mogu vezati u komplekse sa drugim komponentama te na taj način izbjeći detekciju (Mazza, 2007). Metabolizam antocijana uključuje metilaciju, sulfataciju i konjugaciju sa glukuronskom kiselinom te degradaciju glikozidnih kompleksa i heterocikličkih oblika antocijana (Slimestad i sur., 2007). Za navedene pretvorbe potrebno je djelovanje enzima β -D-glukozidaze, β -D-glukuronidaze i α -L-ramnozidaze koji su odgovorni za otpuštanje aglikona iz glikozidnih ili glukuronidnih oblika (Selma i sur., 2009). Pozitivni učinci na zdravlje se mogu povezati sa sporim i kontinuiranim otpuštanjem fenolnih komponenti u krvotok. Bez obzira na njihovu naočigled slabu biodostupnost, utvrđeno je kako su koncentracije antocijana u plazmi dovoljno visoke da induciraju pozitivne promjene u prijenosu signala te genskoj ekspresiji *in vivo*. Poznato je da flavonoidi mogu ulaziti u direktne interakcije sa lipidima membrane, utječući na taj način na fiziološka svojstva membrane, interakcije između liganda i receptora, modulaciju prijenosa signala, transport kroz membranu i enzimsku aktivnost (Verstraeten i sur., 2010). Rezultati velikog broja istraživanja su uniformni u zaključku da, iako postoje određene varijacije u vrijednostima biokinetičkih parametara, antocijani se brzo apsorbiraju i eliminiraju iz organizma. S obzirom na rezultate navedenih istraživanja, možemo zaključiti kako ove biološki aktivne komponente mogu proći kroz gastrointestinalni trakt te dospjeti u sistemsku cirkulaciju u svojoj nativnoj ili metaboliziranoj formi. Zajednički zaključak većine autora jest da su antocijani prisutni u visokim koncentracijama u želudcu, međutim sam mehanizam gastričke apsorpcije nije u potpunosti razjašnjen.

Veliki utjecaj na biodostupnost antocijana imaju slijedeći parametri: (i) varijacije u unosu; (ii) kemijska struktura u različitim prehrambenim izvorima; (iii) način procesiranja i struktura hrane i pića u kojima su prisutni; (iv) dob i spol pojedinaca; (v) upotrijebljena analitička metoda.

Antocijani su hranjive bioaktivne komponente koje imaju dvostruki značaj. Prvi je tehnološki, zbog njihovog utjecaja na senzorske karakteristike prehrambenih proizvoda, a drugi je biološki zbog utjecaja na zdravlje, među kojima je najvažniji kardioprotektivni učinak (De Pascual i Sanchez, 2008).

Zaključci

Zbog napretka industrijalizacije agro-industrijski otpad postaje rastući problem. Ovaj nusproizvod iznimno je bogat polifenolnim spojevima, što otvara mogućnost iskorištenja komine i stvaranja proizvoda dodane vrijednosti. Naime, tijekom prerade grožđa i proizvodnje vina čak 60-70 % bioaktivnih spojeva grožđa zaostaje u komini i ne prelazi u vino, što kominu čini bogatim, jeftinim i lako dostupnim izvorom bioaktivnih spojeva s primjenom u farmaceutskoj, kozmetičkoj i prehrambenoj industriji. Biodostupnost je pojam koji se odnosi na brzinu apsorpcije i količinu aktivne tvari koja doprije u sistemsku cirkulaciju. Bioaktivne komponente iz biljnih izvora moraju imati određenu biodostupnost kako bi ispoljile bilo kakav učinak na organizam. Zbog toga, potrebno je široko znanje o njihovoj farmakokinetici kako bi se utvrdio stvaran utjecaj dnevnog unosa tih komponenata na zaštitu i poboljšanje zdravstvenog statusa.

Medicinska kemija i farmacija / Medical Chemistry and Pharmacy

Zahvala: Ovo istraživanje financirano je sredstvima projekta "Primjena inovativnih tehnologija u izolaciji bioaktivnih spojeva iz organskog otpada u proizvodnji vina". Projekt je sufinancirala Europska unija u okviru poziva RC.2.2.08 „Jačanje kapaciteta za istraživanje, razvoj i inovacije“ financiranog iz Europskog fonda za regionalni razvoj, Operativni program Regionalna konkurentnost 2007. -2013.

Literatura

- Bitsch, R., Netzel, M., Frank, T., Strass, G., Bitsch, I. (2004): Bioavailability and biokinetics of anthocyanins from red grape juice and red wine, *J. Biomed. Biotechnol.* 5, 293–298.
- Borgez, G., Roowi, S., Rovagnet, J.M. (2007): The bioavailability of raspberry anthocyanins and ellagitannins in rats, *Mol. Nutr. Food Res.* 51, 714-725.
- Chen, W., Wang, D., Wang, L.S. (2012): Pharmacokinetics of protocatechuic acid in mouse and its quantification in human plasma using LC-tandem mass spectrometry, *J. Chromatogr. B.* 908, 39-44.
- Chun, O.K., Chung, S.J., Song, W.O. (2007): Estimated dietary flavonoid intake and major food sources of U.S. adults, *J. Nutr.* 137, 1244–1252.
- Cisowska, A., Wojnicz, D., Hendrich, A.B. (2011): Anthocyanins as antimicrobial agents of natural plant origin, *Nat. Prod. Commun.* 6, 149-156.
- Crozier, A., Del Rio, D., Clifford, M.N. (2010): Bioavailability of dietary flavonoids and phenolic compounds, *Mol. Aspects. Med.* 31, 446-467.
- Crozier, A., Jaganath, I.B., Clifford, M.N. (2009): Dietary phenolics: chemistry, bioavailability and effects on health, *Natl. Prod. Rep.* 26, 1001–1043.
- Das, H. (2001): Protein and amino acids from cellulosic wastes of agricultural and food industry – a review, *Indian. Food. Packer.* 55, 57-65.
- De Pascual, T., Sanchez, B.S. (2008): Anthocyanins, from plant to health, *Phytochem. Rev.* 7, 281–299.
- Di Lecce, G., Arranz, S., Jáuregui, O., Tresserra-Rimbau, A., Quifer-Rada, P., Lamuela-Raventós, R.M. (2014): Phenolic profiling of the skin, pulp and seeds of Albariño grapes using hybrid quadrupole time-of-flight and triple-quadrupole mass spectrometry, *Food. Chem.* 145, 874-882.
- Faria, A., Pestana, D., Azevedo, J. (2009): Absorption of anthocyanins through epithelial cells- Putative involvement of GLUT2, *Mol. Nutr. Food Res.* 53, 1430-1437.
- Galvano, F., Frigiola, A., Gazzolo, D., Biondi, A., Malaguarnera, M., Li Volti, G. (2009): Endothelial protective effects of anthocyanins: the underestimated role of their metabolites, *Ann. Nutr. Meta.b* 54, 158–159.
- Garrido, J., Borges, F. (2013): Wine and grape polyphenols - A chemical perspective, *Food. Res. Int.* 54, 1844-1858.
- Ichihyanagi, T., Shilda, Y., Rahman, M.M., Hatano, Y., Konishi, T. (2006): Bioavailability and tissue distribution of anthocyanins in bilberry (*Vaccinium myrtillus* L.) extract in rats, *J. Agric. Food. Chem.* 54, 6578-6587.
- Jakobek, L. (2015): Interactions of polyphenols with carbohydrates, lipids and proteins, *Food. Chem.* 175, 556–567.

- Jennings, A., Welch, A.A., Fairweather-Tait, S.J., Kay, C., Minihane, A.M., Chowienczyk, P., Jiang, B., Cecelja, M., Spector, T., Macgregor, A., Cassidy, A. (2012): Higher anthocyanin intake is associated with lower arterial stiffness and central blood pressure in women, *Am. J. Clin. Nutr.* 96, 781-788.
- Kallithraka, S., Tsoutsouras, E., Tzourou, E., Lanaridis, P. (2005): Principal phenolic compounds in Greek red wines, *J. Food. Chem.* 99, 784-793.
- Kurilich, A.C., Clevidence, B.A., Britz, S.J., Simon, P.W., Novotny, J.A. (2005): Plasma and urine responses are lower for acylated vs nonacylated anthocyanins from raw and cooked purple carrots, *J. Agric. Food. Chem.* 53, 6537-6542.
- Manach, C., Williamson, G., Morand, C., Scalbert, A., Rémésy, C. (2005): Bioavailability and bioefficacy of polyphenols in humans. I. Review of 97 bioavailability studies, *Am. J. Clin. Nutr.* 81, 230-242.
- Mazza, G. (2007): Anthocyanins and heart health, *Ann. Ist. Super. Sanità.* 43, 369-374.
- McGhie, T.K., Ainge, G.D., Barnett, L.E., Cooney, J.M., Jensen, D.J. (2003): Anthocyanin glycosides from berry fruit are absorbed and excreted unmetabolized by both humans and rats, *J. Agric. Food. Chem.* 51, 4539-4548.
- McGhie, T.K., Walton, M.C. (2007): The bioavailability and absorption of anthocyanins: towards a better understanding, *Mol. Nutr. Food Res.* 51, 702-713.
- Milbury, P.E., Cao, G., Prior, R.L., Blumberg, J. (2002): Bioavailability of elderberry anthocyanins, *Mech. Ageing. Dev.* 123, 997-1006.
- Moure, A., Cruz, J.M., Franco, D., Dominguez, J.M., Sineiro, J., Dominguez, H., Nunez, M.J., Parajo, J.C. (2001): Natural antioxidants from residual sources, *Food. Chem.* 72, 145-171.
- Ovando, A.C., Hernandez, L.P., Hernandez, E.P., Rodriguez, J.A., Galan-Vidal, C.A. (2009): Chemical studies of anthocyanins: A review, *Food. Chem.* 113, 859-871.
- Passamonti, S., Vrhovsek, U., Vanzo, A., Mattivi, F. (2003): The stomach as a site for anthocyanins absorption from food, *FEBS Lett.* 544, 210-213.
- Pojer, E., Mattivi, F., Johnson, D., Stockley, C.S. (2013): The Case for Anthocyanin Consumption to Promote Human Health: A Review, *Compr. Rev. Food. Sci. Food. Saf.* 12, 483-508.
- Prior, R.L., Wu, X. (2006): Anthocyanins: structural characteristics that result in unique metabolic patterns and biological activities, *Free. Radical. Res.* 40, 1014-1028.
- Selma, M.V., Espin, J.C., Tomas-Barberan, F.A. (2009): Interaction between phenolics and gut microbiota: Role in human health, *J. Agr. Food. Chem.* 57, 6485-6501.
- Serra, A., Macia, A., Romero, M-P., Pinol, C., Motilva, M-J. (2011): Rapid methods to determine procyanidins, anthocyanins, theobromine and caffeine in rat tissues by liquid chromatography-tandem mass spectrometry, *J. Chromatography B.* 879, 1519-1528.
- Shivashankara, K.S., Acharya, S.N. (2010): Bioavailability of dietary polyphenols and the cardiovascular diseases, *Open Nutraceuticals J.* 3, 227-241.
- Slimestad, R., Fossen, T., Vagen, I.M. (2007): Onions: A source of unique dietary flavonoids, *J. Agr. Food Chem.* 55, 10067-10080.
- Spencer, J.P. (2003): Metabolism of tea flavonoids in the gastrointestinal tract, *J. Nutrition.* 133, 3255-3261.

Medicinska kemija i farmacija / Medical Chemistry and Pharmacy

- Stalmach, A., Edwards, C.A., Wightman, J.D., Crozier, A. (2012): Gastrointestinal stability and bioavailability of (poly)phenolic compounds following ingestion of Concord grape juice by humans, *Mol. Nutr. Food Res.* 56, 497-509.
- Vanzo, A., Vrhovsek, U., Tramer, F., Mattivi, F., Passamonti, S. (2011) Exceptionally fast uptake and metabolism of cyanidin 3-glucoside by rat kidneys and liver, *J. Natl. Prod.* 74, 1049–54.
- Verstraeten, S., Fraga, C., Oteiza, P. (2010): Flavonoids-membrane interactions: Consequences for biological actions. U: *Plant phenolics and human health* (Fraga, C., ured.), John Wiley & Sons Inc., 107-136.
- Vitaglione, P., Donnarumma, G., Napolitano, A., Galvano, F., Gallo, A., Scalfi, L., Fogliano, V. (2007): Protocatechuic acid is the major human metabolite of cyanidin-glucosides, *J. Nutr.* 137, 2043–2048.
- Wrolstad, R.E. (2004): Anthocyanin Pigments - Bioactivity and Coloring Properties, *J Food. Sci.* 69, 419-425.
- Zamora-Ros, R., Agudo, A., Lujan-Barroso, L., Romieu, I., Ferrari, P., Knaze, V., Bueno-de-Mesquita, H.B., Leenders, M., Travis, R.C., Navarro, C., Sánchez-Cantalejo, E., Slimani, N., Scalber, A., Fedirko, V., Hjartåker, A., Engeset, D., Skeie, G., Boeing, H., Förster, J., Li, K., Teucher, B., Agnoli, C., Tumino, R., Mattiello, A., Saieva, C., Johansson, I., Stenling, R., Redondo, M.L., Wallström, P., Ericson, U., Khaw, K.T., Mulligan, A.A., Trichopoulou, A., Dilis, V., Katsoulis, M., Peeters, P.H., Igali, L., Tjønneland, A., Halkjær, J., Touillaud, M., Perquier, F., Fagherazzi, G., Amiano, P., Ardanaz, E., Bredsdorff, L., Overvad, K., Ricceri, F., Riboli, E., González, C.A. (2012): Dietary flavonoid and lignin intake and gastric adenocarcinoma risk in the European Prospective Investigation into Cancer and Nutrition (EPIC) study, *Am. J. Clin. Nutr.* 96, 1398-1408.

Original research paper

The bioavailability of anthocyanins from the skins of red grapes in the serum of C57BL/6 mouse

Irena Landeka Jurčević^{1*}, Monika Fumić¹, Domagoj Đikić², Verica Dragović-Uzelac¹,
Sandra Pedisić¹, Zoran Zorić¹

¹*University of Zagreb, Faculty of Food Technology and Biotechnology Zagreb,
Pierottijeva 6, 10 000 Zagreb, Croatia*

²*University of Zagreb, Faculty of Science Zagreb, Rooseveltov trg 6, 10 000 Zagreb, Croatia*

**Corresponding author: ilandeka@pbf.hr*

Summary

The aim of this study was to investigate the bioavailability of anthocyanins from the skins of red grapes in mouse serum. Anthocyanins are a subgroup of flavonoids and natural plant pigments responsible for various shades of red, purple and blue grapes. The fate of anthocyanins after oral administration follows a unique path that is different from other flavonoids. Differences in the absorption of different types of anthocyanins indicate that the absorption is dependent on the chemical structure of anthocyanins and the type of conjugation. It is difficult to determine the bioavailability of anthocyanins because of supplements which contain several structurally different anthocyanins and because of reactions that allow the conversion of cyanidin into peonidin, delphinidin into petunidin and petunidin into malvidin. This study was carried out on an animal model of C57BL / 6 mice which were treated with the extract from the skins of grapes (GSE). The numbers of serum groups were collected after 15, 30, 60, 120, 180 and 240 min and analyzed on a HPLC-MS (high performance liquid chromatography with MS / MS detection). The dominant metabolites in the serum were: malvidin-3-glucoside (Mal-3-Glc), peonidin-3-glucoside (PEO-3-Glc) and cyanidin-3-glucoside (Cy-3-Glc). The maximum levels of anthocyanidin-glucoside levels in the serum were measured 60 min after the treatment of animals, and were: 63.092; 7.455 and 124.061 ng/mL. The results show that these molecules from a purified extract of grape epidermis improve the total antioxidant capacity of the serum.

Keywords: bioavailability, skins of red grapes, UPLC MS/MS, anthocyanins

Original research paper

Development of protein-polysaccharide complex Hydrogel particles encapsulating model polyphenolic antioxidants

Ana Belščak-Cvitanović^{1*}, Eva Maria Theismann², Arijana Bušić¹, Aleksandra Vojvodić¹,
Julia Keppler², Anja Steffen-Heins², Draženka Komes¹

¹*University of Zagreb, Faculty of Food Technology and Biotechnology,
Pierottijeva 6, 10 000 Zagreb, Croatia*

²*Kiel University, Institute of Human Nutrition and Food Science,
Heinrich-Hecht-Plotz 10, 24118 Kiel, Germany*

**Corresponding author: abelscak@pbf.hr*

Summary

In recent years utilizing biopolymer interactions, or crosslinking-assembled spherical structures, enabled the encapsulation and targeted delivery of numerous active ingredients. The self-assembly of proteins such as zein or casein micelles has already been explored as a vehicle for delivery of hydrophobic bioactive compounds, while the use of alginate-protein or chitosan-protein complexes has been introduced very recently, mostly for encapsulation of pharmaceutical model drugs. In this study we focus on using alginate, chitosan and proteins as biopolymer building blocks for encapsulation of quercetin, a representative poorly water-soluble lipophilic polyphenolic antioxidant.

The approach of improving quercetin solubility in a mixture of ascorbic acid was evaluated, and compared to plain compounds based on their antioxidant capacity. Electrostatic complexation between alginate and chitosan and reinforcement with whey proteins was conducted and mediated additionally by temperature (70°C) and ionic cross-linking. The encapsulation of both quercetin and ascorbic acid was achieved, enabling to entrap up to 66% of quercetin and 54% of ascorbic acid. Macro-sized spherical particles of alginate-chitosan and whey proteins-chitosan were produced ranging up to 2 mm in size, with the use of chitosan enabling the production of smaller particles. Whey protein-chitosan particles were less spherical, but provided the most retarded, prolonged release of quercetin from the particles in simulated gastric and intestinal fluids.

Keywords: antioxidant capacity, encapsulation, proteins, quercetin

Introduction

Currently an increasing tendency is directed towards production of engineered food materials as delivery systems of bioactive, nutraceutical compounds that are mainly structured by a complex assembly of various food ingredients such as proteins, polysaccharides, lipids, sugars, emulsifiers, minerals, and water. Among these components, proteins and polysaccharides play a key role in the structuration and stabilization of food systems through their gelling, thickening, and surface-stabilizing functional properties (Schmitt et al., 1998).

With regard to food applications, those biopolymers are used as wall materials in the formation of micro- and nano-sized particulate systems for delivery of functional ingredients, such as drugs, nutraceuticals, flavors and antimicrobials (Grigoriev & Miller, 2009; McClements et al., 2007; Madene et al., 2006; Weiss et al., 2007; Yagmur & Glatter, 2009). Functionalization of polymeric chains enables to obtain microparticles with new properties, for example resistance to the action of chemical agents (Patel et al., 2010). Moreover, protein-polysaccharide complexes (Augustin et al., 2006; Ducel et al., 2004; Mendanha et al., 2009; Pierucci et al., 2006) are used to improve the emulsifying and filmogenic or other interesting functional properties during microencapsulation. The presence of numerous functional groups on protein surfaces is advantageous from a particle production point of view, since it enables interactions with bioactive compounds, cross-linking agents, or coating substances. Thus, it is possible to custom-design protein-polysaccharide particles with specific physicochemical and functional attributes for different applications (Jahanshahi & Babaei, 2008; Khan & Schneider, 2013).

Electrostatic attractions are essential for the formation of protein-polysaccharide electrostatic complexes, but also of two ionic (opositely charged) polysaccharides. The formulation of protein-polysaccharide particulate systems has also been achieved through heat denaturation of globular proteins followed by electrostatic complexation with polysaccharides, either anionic (e.g., alginate and pectin) or cationic (e.g., chitosan) in nature (Hong & McClements, 2007; Schmitt et al., 1998; Yu et al., 2006). Biopolymer nanoparticles were formulated by thermal treatment of associative complexes of β -lactoglobulin and beet pectin (Jones & McClements, 2008). Aside from chitosan and other naturally charged polyanionic polysaccharides (such as alginate and pectin), the electrostatic complexes of proteins and polysaccharides can be formed from other hydrocolloid biopolymers. For example, Liu et al. (2010) prepared pea protein isolate (PPI) and gum arabic (GA) complexes by mixing them together at pH 8.0 and then adjusting the mixture to the desired acidic pH value. In a study by Yin et al. (2012) acid soluble soybean protein, which contains more soluble protein in acidic solution, and soybean soluble polysaccharide (SSPS) were used to produce complexes.

In order to evaluate the potential of developing a delivery system of a potent bioactive compound in polyelectrolyte polysaccharide or protein-polysaccharide complexes, in the present study quercetin (3,-7-pentahydroxy flavone) was used as a model drug. This lipophilic compound belongs to a subclass of flavonoids known as flavonols. It is one of the most abundant flavonoids in the human diet and is already used in nutraceuticals or food supplements, owing to its antioxidant, anti-inflammatory, anti-bacterial, anti-coagulative and anti-hypertensive properties (Boots et al., 2008). However, in spite of exhibiting a wide range of pharmacological properties, flavonoids and related compounds present obstacles to their pharmaceutical use, due to their poor solubility in aqueous media (Moridani et al., 2002). Therefore, encapsulation of these compounds, using conventional methods is scarce and mostly addressed by encapsulation in liposomes (Frenzel and Steffen-Heins, 2015) or cyclodextrins (Goniotaki et al., 2004; Tommasini et al., 2004), which still presents economically unfeasible and hard to up-scale processes. Since quercetin is a lipophilic compound with limited solubility in water, an approach is required for its delivery in natural hydrophilic biopolymers, which conditions its water solubility. Therefore in the present study, quercetin solubility in water was aimed to be improved in acidic conditions and different combinations of alginate, chitosan and whey proteins were employed to encapsulate this compound, via a particulate system developed by using the natural biopolymers and combinations thereof.

Materials and Methods

Preparation and antioxidant capacity of quercetin solution

In order to improve the dissolution rate of quercetin in water, an approach of lowering the pH value by using ascorbic acid was evaluated in the present study. With the aim of determining the extent of quercetin solubility, the antioxidant capacities of both plain compounds (0.01 g/mL) and the obtained binary mixture (each compound of 0.01 g/mL concentration in the mixture) were evaluated by employing the ABTS radical scavenging assay (Re et al., 1999).

For the encapsulation of quercetin in a hydrophilic media, a solution of ascorbic acid (0.01 g/mL) was prepared and an equal concentration of quercetin added to the final solution (0.01 g/mL).

Preparation of alginate-based blended carrier systems

The preparation of beads was carried out by ionic gelation of alginate and chitosan, following the techniques adopted by Belščak-Cvitanović and colleagues (2011; 2015) and Shu and Zhu (2002), with some modifications. Five delivery systems were formulated; plain sodium alginate (*A*), alginate reinforced with whey proteins (*AWP*) or chitosan (*AChit*), plain chitosan particles (*Chit*) and chitosan reinforced with whey proteins (*ChitWP*). Alginate (2%, w/v), chitosan (4% w/v) and whey protein (10%, w/v) solutions were prepared by dissolving the stated biopolymers in the previously prepared solution of quercetin in ascorbic acid and stirring over night. The *AWP* and *ChitWP* delivery systems contained plain sodium alginate or chitosan and whey protein solution (previously heated to 70°C for 30 min), prepared in mass proportions of 80:20 (w/w), respectively. The plain and blended formulations were well homogenized, sonicated for 15 sec and drawn into a 5 mL syringe attached with a blunt tip and 19-gauge metal needle. The prepared *A* and *AWP* mixtures were encapsulated to a receiving beaker containing 50 mL of cross-linking solution consisting of 2% (w/v) calcium chloride in distilled water. For the chitosan reinforced alginate beads, the cross-linking solution consisted of 2% (w/v) calcium chloride and 1% (w/v) of chitosan dissolved in a solution of ascorbic acid whose pH value was adjusted to 2.5 (as described by Belščak-Cvitanović et al., 2011). In case of chitosan particles, chitosan hydrogel beads were prepared by dripping plain chitosan or chitosanWP solutions (in the same ratio as in case of *AWP* particles) into a receiving solution of 5% (w/v) sodium tripolyphosphate (TPP) in water. The formed beads were left to harden under mixing for 24h. All of the obtained beads were removed from the hardening solutions, rinsed with distilled water and stored in refrigerated conditions or freeze dried.

Hydrogel beads image acquisition and capture

The surface morphology, particle size and appearance of randomly selected hydrogel beads were examined by an optical microscope (Leica Microsystems, Wetzlar, Germany) and a high-resolution digital microscope AM413T5 (Dino-lite Pro, Taiwan). Using the accompanied software, microscope was calibrated and photographs of samples with 1280 x 1024 resolutions were acquired directly into software and stored in JPEG (Joint Photographic Experts Group) format of superfine quality. 4-100x magnifications were used for all samples. The mean size of obtained beads was determined by using the diameter circle measurement function of the microscope, which allowed the reading of the diameter of beads upon capturing their images. The particle size was also confirmed by manual reading of the size of beads upon placing them on a measurement/calibration scale and deducing the

mean value for each sample. Humidity content (%) was measured gravimetrically, by drying the beads in an oven at 105°C until constant weight (AOAC, 1996).

Encapsulation efficiencies and release profiles of entrapped bioactives

The contents of quercetin and ascorbic acid entrapped in the produced beads were estimated by crushing a known amount of the freeze dried beads using a mortar and pestle and then solubilizing in methanol or in 1% of meta-phosphoric acid solution (MPA) in case of ascorbic acid, under vigorous shaking on a Vortex mixer (Tehnica, Železniki, Slovenia). The content of quercetin loaded in the beads was determined by HPLC analysis, while the content of ascorbic acid was determined spectrophotometrically using the DCPIP reagent (Barros et al., 2008). The HPLC analysis of quercetin content was conducted according to the method described by Belščak-Cvitanović et al. (2011) using an Agilent 1100/1200 Series HPLC device (Agilent, Santa Clara, USA) and a Photodiode Array detector (Agilent, Santa Clara, USA) by using a reversed-phase ACE C-18 column (250 x 4.6 mm, 5 µm i.d.). All analyses were repeated three times.

The percentage of loading efficiencies was calculated as the ratio between the quercetin or ascorbic acid contents in the solution of disintegrated beads and their respective contents in the initial encapsulant solution.

Release profiles of entrapped bioactives

The release of quercetin and the antioxidant capacity from the obtained beads in simulated gastric and intestinal fluids (SGF and SIF) was performed by evaluating the quercetin content by HPLC analysis and antioxidant capacity by using the spectrophotometric ABTS radical scavenging assay. The fluids used for the study included pH = 1.2 (0.1 M HCl+pepsin) and phosphate buffer, pH 7.4 containing pancreatin as simulated gastric and intestinal fluids (SGF and SIF), respectively, as proposed by the European Pharmacopeia 7.0. For the analysis a known amount of particles (of about 3g) was suspended in 50 mL of simulated fluids at 37°C. The samples were submitted to continuous agitation on an orbital shaker (New Brunswick Scientific Co., Inc., Edison, NJ) operating at 100 rpm. At defined time intervals, an aliquot of the medium was taken for analysis and replaced by the same amount of fresh medium.

Results and Discussion

The pharmacological activities of quercetin, have been well known and its use is expanding in recent years (White et al., 2007), which can be attributed to the higher antioxidant activity of quercetin in comparison to the other well-known antioxidant molecules such as ascorbyl palmitate, trolox and rutin because of the number and position of free hydroxyl groups in the quercetin molecule (Nathiya et al., 2014). These results are in agreement with the results obtained in the present study (Figure 1), where the ABTS radical scavenging capacity revealed higher antioxidant capacity of quercetin than in comparison to ascorbic acid.

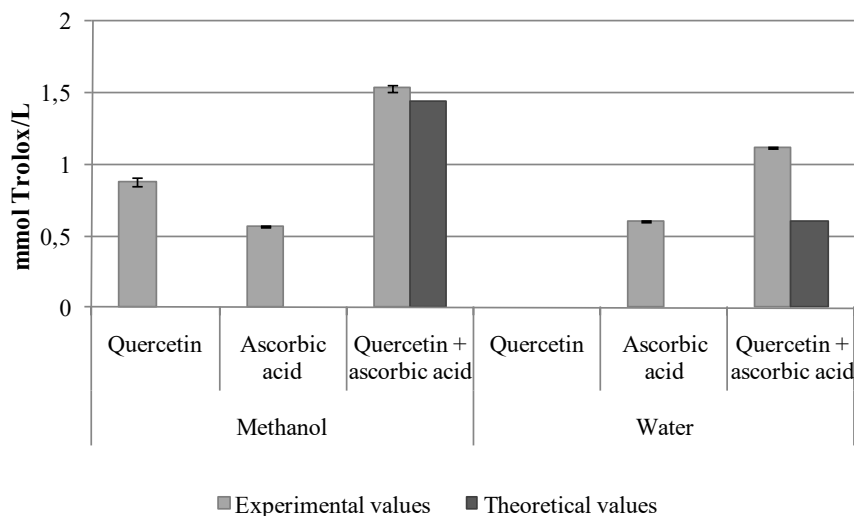

Fig. 1. Antioxidant capacity of plain quercetin and ascorbic acid solutions and their binary mixture in methanol and water

However, this was observed only in case of methanolic solutions of those compounds, where quercetin exhibits complete solubility. In case of a binary mixture of those two compounds, almost 2-fold higher antioxidant capacity was achieved than in comparison to plain quercetin and 3-fold higher when compared to plain ascorbic acid. If the observed antioxidant capacity is compared to the theoretical value (sum of antioxidant capacities of plain quercetin and ascorbic acid solutions), approx. 10% higher antioxidant capacity of the formulated binary mixture was obtained, indicating a potential synergistic effect of the combination of those two compounds. However, since the food requirements of antioxidant nutraceuticals are limited to nontoxic solvents, the quercetin should be readily delivered in water, which results with no antioxidant capacity of that compound, as indicated on Figure 1. After dissolution of quercetin in the previously prepared ascorbic acid solution, and formulating a binary mixture, its resulting antioxidant capacity is significantly increased.

In order to enable the use of quercetin in therapeutic and food applications and to overcome the issue of its poor solubility in water, which restricts the use of this flavonoid mainly to oral administration (Nathiya et al., 2014), encapsulation of the binary solution of quercetin and ascorbic acid was performed via ionic gelation of several natural biopolymers and their combinations. Iontropic gelation of sodium alginate (-) and chitosan (+) is well known and is based on the ability of polyelectrolytes to cross link in the presence of polyvalent counter ions (calcium (+) and TPP (-)) to form hydrogel beads. The resulting spherical hydrophilic polymeric entities are capable of extensive gelation and swelling in simulated biological fluids and the release of drug controlled by polymer relaxation. The alginate particles formulated in that way are characterized by extremely porous hydrogel structure, which results with fast release kinetics of entrapped active compound occurring due to diffusion based mechanisms.

Based on previous research, the release kinetics can be improved i.e. prolonged by reinforcing the basic delivery carrier especially alginate with an adjunct biopolymer, thereby influencing the hydrogel porosity and modifying the encapsulation and loading capacities and release profiles (Belščak-Cvitanović et al., 2015).

The approach employed in the present study focuses on the exploitation of polyelectrolyte protein-polysaccharide interactions to reinforce and entrapp a hydrophobic active compound (quercetin) in the previously stated hydrogel particulate systems. Preliminary experiments conducted by dripping technique of the polymer solution containing the active compound (i.e. internal gelation) produced large spherical beads ranging up to 2 mm in size (Table 1). Such beads, constituted of a gelled polymeric matrix, imbibe large amounts of water, up to 95%, which is according to the obtained results dependent on the delivery system composition. The reinforcement of plain biopolymers alginate and chitosan with whey proteins (or chitosan) resulted in reduction of the particle size which may be an indication of occurring polyelectrolyte interactions and more pronounced gel formation. This may result in better crosslinking and less interstitial spaces in the hydrogel, thus producing smaller particles. This indicates that upon up-scaling of the bead production, and employment of extrusion-assisted encapsulation to produce micro-sized beads, the reinforced polyelectrolyte particles may be preferred over the plain polymeric systems.

Table 1. Humidity, particle size and encapsulation efficiencies of quercetin and ascorbic acid in different biopolymer-based hydrogel beads

	Humidity	Particle size	Encapsulation efficiency _{quercetin}	Encapsulation efficiency _{ascorbic acid}
	%	mm	%	%
A	95.23 ± 0.21	1.97 ± 0.05	56.82 ± 1.52	51.28 ± 1.25
AWP	93.81 ± 0.07	1.82 ± 0.04	64.82 ± 0.58	53.49 ± 2.41
AChit	92.15 ± 0.18	1.78 ± 0.09	65.54 ± 0.08	49.73 ± 1.57
Chit	93.23 ± 0.31	1.54 ± 0.25	61.17 ± 2.37	43.89 ± 3.23
ChitWP	92.42 ± 0.29	1.48 ± 0.16	61.28 ± 4.51	45.92 ± 1.18

According to the determined encapsulation efficiencies (Table 1), both quercetin and ascorbic acid were retained in the hydrogel beads matrix. In relation to the initial drug content of the encapsulant solution, up to 66% of quercetin and 53% of ascorbic acid was efficiently loaded in the formulated beads. The results revealed that reinforcement of alginate with whey proteins or chitosan improves the encapsulation efficiency of the two active compounds in comparison to plain alginate. The reason for that may be attributed to the formation of complexes between the two biopolymers by electrostatic complex coacervation, which reduced the hydrogel matrix porosity and contributed to better active compound retention. Namely, the pH plays a key role in the formation of complexes because of its effect on the ionization degree of the functional side groups carried by the

Medicinska kemija i farmacija / Medical Chemistry and Pharmacy

biopolymers (i.e., amino and carboxylic groups). For this reason, considering a mixture containing an anionic polysaccharide and a protein, the maximum coacervation yield is obtained below the pI of the protein, where the two biopolymers carry exactly opposite net charges, resulting in maximum electrostatic attraction (Schmitt et al., 1998). In the present study, by using ascorbic acid, low pH value of the encapsulant solution is achieved which intensifies the formation of polyelectrolyte complex coacervates, and in this case resulted with higher encapsulation efficiency of used bioactives in those matrices. The non-significant difference of encapsulation efficiency of chitosan reinforced with whey proteins indicates that no marked interactions or polyelectrolyte attractions occurred that improved the gel structure. This may be the consequence of repulsive forces between positively charged biopolymers, while any electrostatic attractions were probably hindered by a high polyanion concentration (TPP) used for crosslinking of that delivery system. Namely, the ionic strength of the biopolymer solution is an important factor affecting complex coacervation. At high salt concentration, the net charge carried by the biopolymers is reduced by interaction with the ions, resulting in a decrease of the electrostatic attraction between the macromolecules (Schmitt et al., 1998). With regard to the morphological properties, spherical structure of all produced particles was obtained, as indicated on Figure 2a-e, with minor differences between particles produced with adjunct protein or chitosan biopolymers.

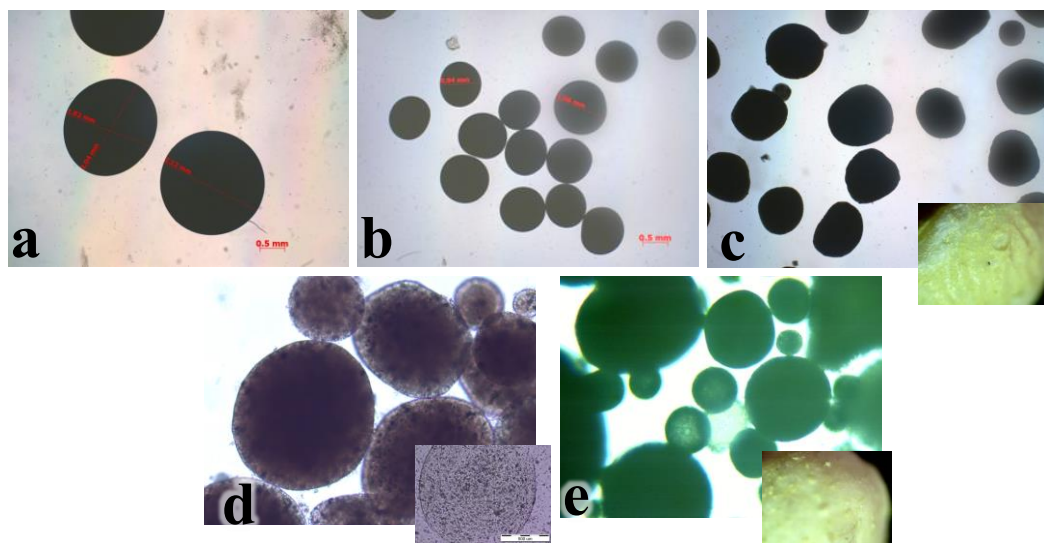

Fig. 2. Optical microscopy images of a) plain alginate (A), b) alginate reinforced with whey proteins (AWP), c) alginate reinforced with chitosan (AChit), d) plain chitosan (Chit) and e) chitosan reinforced with whey proteins (ChitWP) hydrogel particles (enhancement 10x)

**small inserts on figures c, d and e display optical microscopy images of the surface of corresponding particles taken at 40x enhancement*

Plain chitosan particles (Figure 2d) were however very fragile with poor mechanical strength, which can be seen as very thin border of the bead formulated by TPP crosslinking of chitosan solution. Stable and sufficiently rigid particles were obtained by reinforcement of chitosan with whey proteins (Figure 2e), which produced less spherical particle structure and more smaller particles, indicating on a non-homogenous and much wider particle size distribution. The fragile, poor textural properties of TPP crosslinked chitosan particles have been well established (Shu and Zhu, 2002), which was previously resolved by reinforcement of chitosan with other biopolymers, such as gelatin (Shu and Zhu, 2000) or alginate (Aral and Akbuga, 1998). Closer morphological surface structure of the beads reinforced with whey proteins (both alginate and chitosan particles) and chitosan revealed a more uneven surface, with prominent protrusions and smaller coagulates occurring on the surface, indicating a potential interacted coagulates formed by the polyelectrolyte carriers.

By taking into account the encapsulation efficiencies of both quercetin and ascorbic acid, no significant differences between the encapsulation efficiencies of alginate- and chitosan-based particles were observed. However, the release profiles of active compounds from the formulated particles in simulated gastric and intestinal fluids (Figure 3a, b) revealed better delivery system performance in case of using chitosan as the carrier biopolymer. Namely, the release patterns of quercetin from the formulated particles (Figure 3a) did not differ markedly between alginate-based and chitosan-based particles in the gastric conditions since almost no release of quercetin was detected. This may be the consequence of interactions between quercetin and the delivery matrix constituents or simply the inability to diffuse out of the particle due to poor water solubility. Concerning the alginate particles, a rapid increase in the quercetin content is observable in the intestinal conditions, due to disintegration of the particles caused by the presence of sequestrant ions in the medium.

Since the release patterns of quercetin revealed no release occurring in the gastric and intestinal media, the antioxidant capacity was determined as a measure of the activity of released antioxidant compounds (quercetin and ascorbic acid). Figure 3b reveals that a fast burst-release occurs during the first 10 minutes in simulated gastric conditions from all alginate-based particles. This effect is attributed to the pronounced porosity of ionically crosslinked alginate gel and diffusion-driven release of the active compounds into surrounding medium. The release from alginate-based particles is further extended in simulated intestinal conditions until complete disintegration of the particles caused by the presence of sequestrant ions in the medium. In case of chitosan particles, a slower but still pronounced antioxidant capacity was observed in the presence of gastric medium, while the release was continued further up to 4h in the intestinal conditions.

In case of chitosan-based particles, the rigid structure of particles was preserved, with no disintegration of particles observed, indicating that chitosan particles may reach the colon and the content of active compounds retained in the particles become available and active in that GI part. This finding is similar to previous findings on release rates of polyphenolic antioxidants from chitosan beads (Trifković et al., 2014) and justifies the frequent previous use of chitosan particles as colon-targeted delivery systems.

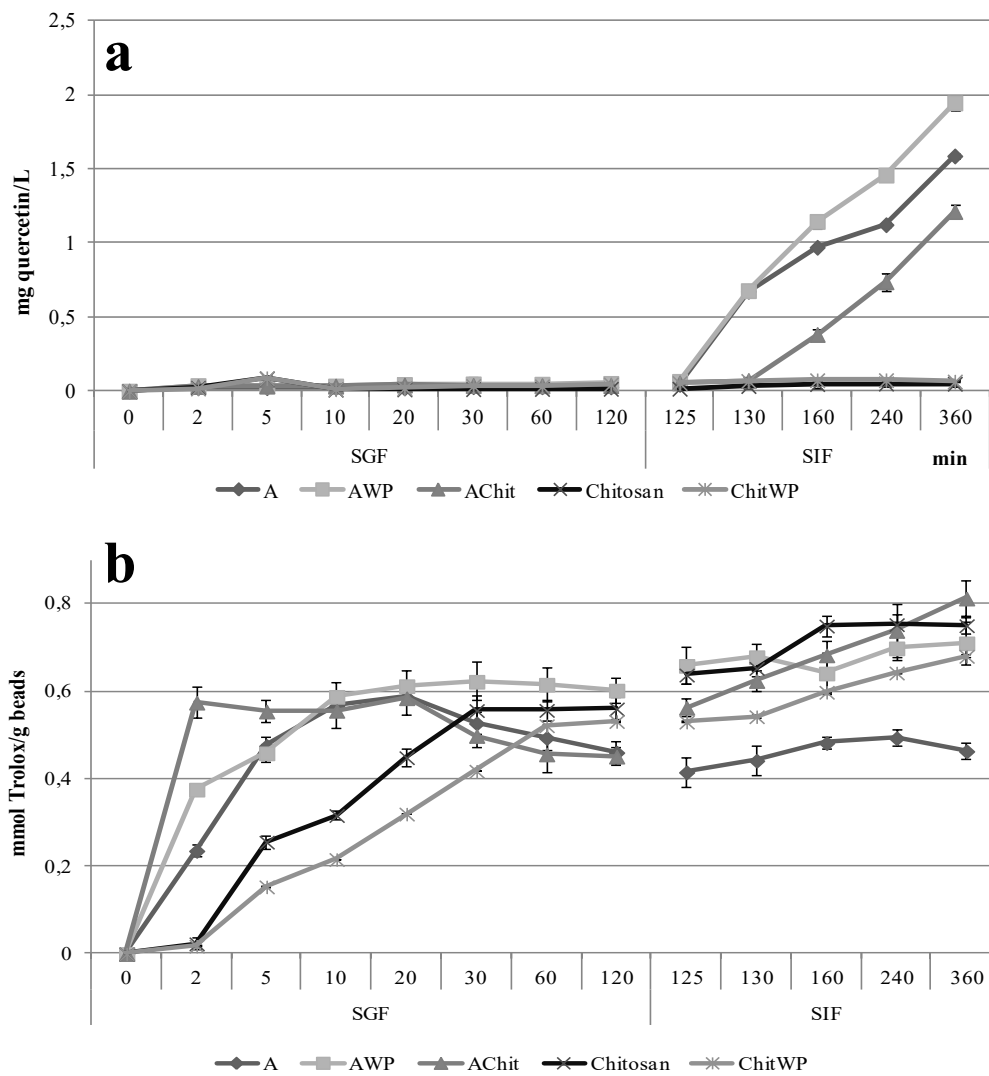

Fig. 3. Release profile of a) quercetine and b) antioxidant capacity of formulated delivery systems during the release experiments in simulated gastric (SGF) and intestinal fluids (SIF)

Conclusions

Findings obtained in this study could facilitate the design of effective delivery systems for encapsulation, protection, and release of bioactive flavonoids with potential to improve human health or increase the shelf life of pharmaceutical or food products. The use of ascorbic acid in combination with quercetin enables to enhance the antioxidant capacity and to intensify the protein-polysaccharide polyelectrolyte attractions that contribute to better encapsulation efficiency. The protein-polysaccharide complexes of alginate and chitosan with whey proteins are preferred over the plain biopolymers as delivery systems of quercetin, as well as ascorbic acid. These particulate systems may be suitable for their use in pharmaceutical and food applications and for the development of functional foods in the near future.

Acknowledgements: This study is a contribution to the bilateral German-Croatian scientific project „Application of different encapsulation techniques for novel nutraceutical formulations using protein-polysaccharide delivery systems“, which is funded by the Croatian Ministry of Science, Education and Sports and German Academic Exchange System (DAAD).

References

- AOAC International (1996): Official Methods of Analysis. 16th ed., Association of Official Analytical Chemists Int., Arlington, USA.
- Aral, C., Akbuga, J. (1998): Alternative approach to the preparation of chitosan beads, *Int. J. Pharm.* 168, 9–15.
- Augustin, M.A., Sanguansri, L., Bode, O. (2006): Maillard reaction products as encapsulants for fish oil powders, *J. Food Sci.* 71, 25-32.
- Barros, L., Falcão, S., Baptista, P., Freire, C., Vilas-Boas, M., Ferreira, I.C.F.R. (2008): Antioxidant activity of Agaricus sp. mushrooms by chemical, biochemical and electrochemical assays, *Food Chem.* 111, 61–66.
- Belscak-Cvitanovic, A., Dordevic, V., Karlovic, S., Pavlovic, V., Komes, D., Jezek, D., Bugarski, B., Nedovic, V. (2015): Protein-reinforced and chitosan-pectin coated alginate microparticles for delivery of flavan-3-ol antioxidants and caffeine from green tea extract, *Food Hydrocoll.* 51, 361-374.
- Belščak-Cvitanović, A., Stojanović, R., Manojlović, V., Komes, D., Juranović Cindrić, I., Nedović, V., Bugarski, B. (2011): Encapsulation of polyphenolic antioxidants from medicinal plant extracts in alginate-chitosan system enhanced with ascorbic acid by electrostatic extrusion, *Food Res. Int.* 44, 1094-1101.
- Boots, A.W., Haenen, G.R.M.M., Basr, A. (2008): Health effects of quercetin: from antioxidant to nutraceutical, *Eur. J. Pharm.* 585, 325–327.
- Ducel, V., Richard, J., Saulnier, P., Popineau, Y., Boury, F. (2004): Evidence and characterization of complex coacervates containing plant proteins: application to the microencapsulation of oil droplets, *Colloid. Surface.* 232, 239-247.
- Frenzel, M., Steffen-Heins, A. (2015): Impact of quercetin and fish oil encapsulation on bilayer membrane and oxidation stability of liposomes, *Food Chem.* 185, 48-57.

Medicinska kemija i farmacija / Medical Chemistry and Pharmacy

- Goniotaki, M., Hatziantoniou, S., Dimas, K., Wagner, M., Demetzos, C. (2004): Encapsulation of naturally occurring flavonoids into liposomes: physicochemical properties and biological activity against human cancer cell lines, *J. Pharm. Pharmacol.* 56, 1217–1224.
- Grigoriev, D. O., Miller, R. (2009): Mono- and multilayer covered drops as carriers, *Curr. Opin. Colloid Interface Sci.* 14(1), 48–59.
- Hong, Y. H., McClements, D. J. (2007): Formation of hydrogel particles by thermal treatment of beta-lactoglobulin-chitosan complexes, *J. Agric. Food Chem.* 55(14), 5653–5660.
- Jahanshahi, M., Babaei, Z. (2008): Protein nanoparticle: A unique system as drug delivery vehicles. *Afr. J. Biotechnol.* 7, 4926–4934.
- Jones, O. G., McClements, D. J. (2008): Stability of biopolymer particles formed by heat treatment of b-lactoglobulin/beet pectin electrostatic complexes, *Food Biophys.* 3, 191–197.
- Khan, S. A., Schneider, M. (2013): Improvement of nanoprecipitation technique for preparation of gelatin nanoparticles and potential macromolecular drug loading, *Macromol. Biosci.* 13(4), 455–463.
- Liu, S., Elmer, C., Low, N.H., Nickerson, M.T. (2010): Effect of pH on the functional behaviour of pea protein isolate–gum arabic complexes, *Food Res. Int.* 43, 489–495.
- Madene, A., Jacquot, M., Scher, J., Desobry, S. (2006): Flavour encapsulation and controlled release – a review, *Int. J. Food Sci. Technol.* 41(1), 1–21.
- McClements, D. J., Decker, E. A., Weiss, J. (2007): Emulsion-based delivery systems for lipophilic bioactive components, *J. Food Sci.* 72(8), R109–R124.
- Mendanha, D.V., Ortiz, S.E.M., Favaro-Trindade, C.S., Mauri, A., Monterrey-Quintero, E.S., Thomazini, M. (2009): Microencapsulation of casein hydrolysate by complex coacervation with SPI/pectin, *Food Res. Int.* 42, 1099–1104.
- Moridani, M. Y., Galati, G., O'Brien, P. J. (2002): Comparative quantitative structure toxicity relationships for flavonoids evaluated in isolated rat hepatocytes and HeLa tumor cells, *Chem. Biol. Interact.* 139, 251–264.
- Nathiya, S., Durga, M., Devasena, T. (2014): Quercetin, encapsulated quercetin and its application – a review, *Int. J. Pharm. Pharm. Sci.* 6, 20–26.
- Patel, S.K., Lavasanifar, A., Choi, P. (2010): Molecular dynamics study of the encapsulation capability of a PCL–PEO based block copolymer for hydrophobic drugs with different spatial distributions of hydrogen bond donors and acceptors, *Biomaterials* 31, 1780–1786.
- Pierucci, A.P.T.R., Andrade, L.R., Baptista, E.B., Volpato, N.M., Rocha-Leao, M.H.M. (2006): New microencapsulation system for ascorbic acid using pea protein concentrate as coat protector, *J. Microencapsul.* 23, 654–662.
- Re, R., Pellegrini, N., Proteggente, A., Pannala, A., Yang, M., Rice-Evans, C. (1999): Antioxidant activity applying an improved ABTS radical cation decolorisation assay, *Free Radic. Biol. Med.* 26, 1231–1237.
- Schmitt, C., Sanchez, C., Desobry-Banon, S., Hardy, J. (1998): Structure and Technofunctional Properties of Protein-Polysaccharide Complexes: A Review. *Critical Reviews in Food Science and Nutrition*, *Crit. Rev. Food Sci. Nutr.* 38(8), 689–753.
- Shu, X.Z., Zhu, K.J. (2000): A novel approach to prepare tripolyphosphate/chitosan complex beads for controlled release drug delivery, *Int. J. Pharm.* 201, 51–58.

- Shu, X.Z., Zhu, K.J. (2002): Controlled drug release properties of ionically cross-linked chitosan beads: the influence of anion structure, *Int. J. Pharm.* 233, 217–225.
- Tommasini, S., Calabro, M. L., Donato, P., Raneri, D., Guglielmo, G., Ficarra, P., Ficarra, R. (2004): Comparative photodegradation studies on 3-hydroxyflavone: influence of different media, pH and light sources, *J. Pharm. Biomed. Anal.* 35, 389–397.
- Trifković, K., Milašinović, N., Djordjević, V., Zdunić, G., Kalagasidis Krušić, M., Knežević-Jugović, Z., Šavikin, K., Nedović, V., Bugarski, B. (2015): Chitosan crosslinked microparticles with encapsulated polyphenols: Water sorption and release properties. *J. Biomater. Appl.* DOI: 10.1177/0885328215598940.
- Weiss, J., Decker, E. A., McClements, D. J., Kristbergsson, K., Helgason, T., Awad, T. (2007): Solid lipid nanoparticles as delivery systems for bioactive food components. In: 2nd International Symposium on Delivery of Functionality in Complex Food Systems, Amherst, pp. 146–154.
- White, C.P., Hirsch, G., Patel, S., Adams, F., Peltekian, K.M. (2007): Complementary and alternative medicines use by patients chronically infected with hepatitis C virus, *Canadian J. Gastroenterol.* 21(9), 589-95.
- Yagmur, A., Glatter, O. (2009): Characterization and potential applications of nanostructured aqueous dispersions, *Adv. Colloid Interface Sci.* 147–148, 333–342.
- Yin, B., Deng, W., Xu, K., Huang, L., Yao, P. (2012): Stable nano-sized emulsions produced from soy protein and soy polysaccharide complexes, *J. Colloid Interface Sci.* 380, 51–59.
- Yu, S. Y., Hu, J. H., Pan, X. Y., Yao, P., Jiang, M. (2006): Stable and pH-sensitive nanogels prepared by self-assembly of chitosan and ovalbumin, *Langmuir* 22(6), 2754–2759.

Sekcija: Zaštita okoliša
Session: Environmental Protection

Izvorni znanstveni rad

Obrada otpadne vode iz procesa proizvodnje maslinovog ulja postupcima adsorpcije i biosorpcije

Dajana Kučić*, Denija Krivičić, Felicita Briški

Sveučilište u Zagrebu, Fakultet kemijskog inženjerstva i tehnologije,
Zavod za industrijsku ekologiju, Marulićev trg 19, 10000 Zagreb, Hrvatska

*Dopisni autor: dkucic@fkit.hr

Sažetak

Aktivni ugljik uklonio je 47 % fenola i 38 % organske tvari, kora banane 23 % fenola i 0 % organske tvari, a modificirana komina masline 15 % fenola i 13 % organske tvari unutar dva sata. Micelijska zrnca *Aspergillus niger* i *Stachybotrys* sp. uklonili su 43 % i 19 % fenola, 42 % i 0 % organske tvari te 38 % i 7 % boje vode. Adsorpcijski i biosorpcijski kapacitet aktivnog ugljika i micelijskog zrnca *Aspergillus niger* prilikom adsorpcije i biosorpcije fenola i organske tvari iznosio je 2,38 mg g⁻¹ i 376 mg g⁻¹, odnosno 138 mg g⁻¹ i 3.206 mg g⁻¹. Ravnotežni parametri adsorpcije i biosorpcije fenola i organske tvari izražene kao KPK vrijednost na aktivni ugljik i micelijsko zrno *Aspergillus niger* procijenjeni su usporedbom eksperimentalnih rezultata s teorijskim vrijednostima dobivenim primjenom Langmuirovog i Freundlichovog modela. Najbolje slaganje dobiveno je primjenom Langmuirovog modela prilikom adsorpcije fenola i organske tvari na aktivni ugljik te podjednako slaganje Langmuira i Freundlichovog prilikom biosorpcije na micelijska zrnca *Aspergillus niger*.

Ključne riječi: otpadna voda iz procesa proizvodnje maslinovog ulja, fenoli, adsorpcija, biosorpcija, Langmuirov i Freundlichov model

Uvod

Početak ovog stoljeća bogatstvo prirodnih resursa i očuvanje okoliša privlači sve veću pažnju čovječanstva te svako ljudsko djelovanje nastoji obuhvatiti koncept održivog razvoja u svrhu rješavanja ekoloških i gospodarskih problema koji do sada nisu bili od velikoga značaja. Živi svijet zasnovan je na vodi, koja je nezamjenjivo prirodno bogatstvo te obuhvaća veliki dio planeta Zemlje (Tušar, 2004). Iako je nepresušan prirodni resurs, ipak se može lokalno i regionalno iscrpiti. Stoga je potrebno održavanje ravnoteže i sprječavanje iscrpljivanja vode kao suštinskog elementa okoliša (Jurac, 2009). U mediteranskom podneblju široko su rasprostranjeni nasadi maslina te prerada plodova i proizvodnja gotovo najdragocjenijeg proizvoda - maslinovog ulja. U agroindustrijskom procesu prerade maslina u svrhu proizvodnje maslinovog ulja nastaje otpadna voda koja je karakterizirana visokim organskim opterećenjem (vrijednost kemijske potrošnje kisika (KPK) u rasponu od 47 - 178 g O₂/dm³ (Morillo et al., 2009)) i visokom koncentracijom fenola (0,5-10,7 g/dm³ (Morillo i sur., 2009)), niskom pH - vrijednošću (pH = 4 - 5 (Akar i sur., 2009)), visokom provodnošću (5,50 - 10 dS m⁻¹ (Paredes i sur., 1997)), toksična je i tamne boje.

Otpadna voda iz proizvodnje maslinovog ulja sadrži visoke koncentracije fenola koji su štetni i toksični, a njezino ispuštanje u okoliš, bez prethodne obrade, može uzrokovati obojenje prirodnih voda, promjene kvalitete tla te fitotoksičnost. Primjerice, pri ispuštanju 10 % te vode bez prethodne obrade, biljka *Vicia faba* je pokazala smanjenje mitotske aktivnosti, a pri ispuštanju 20 % pokazuje potpunu mitotsku neaktivnost (Achack i sur., 2009; El Hajjouji i sur., 2014). Ako se iz takve otpadne vode ne uklone onečišćujuće i/ili štetne tvari i ispuste u okoliš, dolazi do narušavanja prirodne ravnoteže kisika. Zbog toga se iz otpadnih voda nastalih tijekom proizvodnje maslinovog ulja (OVM) mora prije ispuštanja u vodeni okoliš odnosno u sustav javne odvodnje ukloniti onečišćujuće i/ili štetne tvari kako bi se zadovoljili izlazni fizikalno-kemijski pokazatelji prema Pravilniku o граниčnim vrijednostima emisija NN 80/13. Sukladno Pravilniku NN 80/13 граниčne vrijednosti emisija fenola i vrijednosti KPK u otpadnim vodama prilikom ispuštanja u sustav javne odvodnje moraju iznositi 0,01 g/dm³, odnosno 0,7 g O₂/dm³. Postoje različiti načini obrade vode među kojima su fizikalni (adsorpcija, biosorpcija), kemijski (katalitička oksidacija) i biološki (biorazgradnja – kulturama kao što su primjerice *Phanerochaete chrysosporium* (Mann i sur., 2008), *Pleurotus ostreatus* (Mann i sur., 2008), *Geotrichum candidum* (Bleve i sur., 2011; Gracia i sur., 2000), *Candida* spp. (Ben Sasi i sur., 2008), *Trichosporon montevidense* (Hui i sur., 2011) itd.). Prilikom odabira načina obrade treba uzeti u obzir niz faktora, odnosno vrstu onečišćujuće tvari i medij u kojem oni opstaju (Briški i sur., 1994). Adsorpcija i biosorpcija se najčešće primjenjuju jer su ekonomski prihvatljive tehnike, jednostavan je operacijski sustav te zbog dostupnosti i raširenosti sorbensa i mogućnosti njihove regeneracije (Achak i sur., 2009; Gracia i sur., 2000; Lasaridi i sur., 2010; Santi i sur., 2008).

U ovom radu provedena je obrada otpadne vode iz procesa proizvodnje maslinovog ulja porijeklom iz sjevernog i južnog priobalja Republike Hrvatske adsorpcijom na aktivni ugljik, koru banane i na modificiranu kominu masline te biosorpcijom na micelijska zrnca *Aspergillus niger* i *Stachybotrys* sp. Svrha šaržnih adsorpcijskih i biosorpcijskih eksperimenata bila je ispitivanje učinkovitosti adsorbensa i biosorbensa za uklanjanje boje, fenola i ukupne organske tvari. Rezultati dobiveni primjenom diskontinuiranog procesa omogućili su odabir adsorbensa i biosorbensa te su primijenjeni za utvrđivanje ravnotežnih parametara diskontinuiranog adsorpcijskog procesa, odnosno opisani su Langmuirovom i Frenlichovom izotermom. Ravnotežni parametri procijenjeni su nelinearnom regresijom u programskom paketu *Scientist*.

Materijali i metode

Otpadna voda iz procesa proizvodnje maslinovog ulja (OVM)

Ispitivana otpadna voda, nastala kontinuiranim trostupanjskim procesom ekstrakcije maslinovog ulja, porijeklom je iz uljara sjevernog i južnog priobalja Republike Hrvatske. Otpadna voda pohranjena je u plastičnim spremnicima u zamrzivaču na temperaturi od -18 °C.

Adsorbensi

Adsorbensi koji su se koristili u eksperimentima su: aktivni ugljik (Silcarbon K835, Njemačka), modificirana kominu masline (Istra, Hrvatska) i kora banane (kućanski otpad). Veličine čestica aktivnog ugljika, modificirane komine maslina i kore banane iznosile su 0,6 - 2,4 mm, 0,5 - 2 mm, odnosno 2 - 5 mm. Aktivni ugljik je u svim pokusima prethodno opran u razrijeđenoj klorovodičnoj

Zaštita okoliša / Environmental Protection

kiselini i osušen na 105 °C. Komina masline modificirana je stajanjem u kiselom mediju (m (konc. H_2SO_4)/ m (komine) = 1/8) 48 sati te po završetku modifikacije isprana je s 1 mol dm^{-3} NaOH i deioniziranom vodom te osušena na 105 °C. Kora banane je isprana deioniziranom vodom te osušena na 105 °C.

Biosorbensi

Plijesni *Aspergillus niger* i *Stachybotrys* sp. izolirani su iz OVM, održavani su precjepeljivanjem na kosu hranjivu podlogu, sladni agar, i inkubirani su na 28 °C, 3-5 dana. Iz izoliranih čistih kultura uzgojila su se micelijska zrnca u svrhu provođenja biosorpcije.

Hranjive podloge za uzgoj mikroorganizama

Za određivanje ukupnog broja bakterija i gljiva (funga) priređivane su u Erlenmeyer tikvicama hranjive podloge prema uputama proizvođača (Biolife Manual, second edition, Ingraf, Italija 1991.). Hranjivi agar korišten je za uzgoj bakterija, a sladni (malt) agar za uzgoj gljiva.

Analitički postupci

Fizikalno-kemijska analiza otpadne vode

Koncentracija suspendirane tvari određivana je prema standardnoj metodi (APHA, 1999) filtriranjem po 5 cm^3 uzorka otpadne vode kroz membranski filter veličine pora $0,45 \mu\text{m}$ koji je potom osušen na 105 °C do konstantne mase. Vrijednosti pH te električna vodljivosti određene su pH elektrodom odnosno konduktometrijskom ćelijom Multi 340i WTW. Koncentracija fenola određivana je spektrofotometrijski pri valnoj duljini od 500 nm prema standardnoj metodi 4-aminoantipyrin-om (APHA, 1999). Organsko opterećenje izraženo kao kemijska potrošnja kisika ($\text{mg O}_2 \text{ dm}^{-3}$) određeno je spektrofotometrijski pri valnoj duljini od 670 nm prema standardnoj metodi (APHA, 1999). Boja uzoraka otpadne vode određivana je spektrofotometrijski pri valnoj duljini od 400 nm.

Mikrobiološka analiza otpadne vode

Ukupan broj živih stanica bakterija i gljiva (CFU; Colony Forming Units) određivan je nacjepljivanjem po 1 cm^3 dobro homogenizirane OVM, originalnog uzorka te određenog decimalnog razrjeđenja, u Petrijeve zdjelice koje su zalivene hranjivim agarom odnosno sladnim agarom. Petrijeve zdjelice inkubirane su pri 37 °C, 24 - 48 h, za bakterije, odnosno pri 28 °C, 3 - 5 dana, za gljive, a broj mikroorganizama određivan je brojanjem izraslih kolonija i rezultat je izražen kao CFU cm^{-3} . Kolonije mikroorganizama (kvasci i plijesni) koje su izrasle na podlozi više puta su precjepeljivane tehnikom iscrpljivanja na sladni agar kako bi se dobila čista kultura i zasebne kolonije. Identifikacija kvasaca i plijesni provodila se korištenjem API stripa 20 C AUX, odnosno mikroskopiranjem pod povećanjem od 400 x i pregledom morfoloških značajki.

Postupci provedenih ispitivanja

Taloženje i filtracija onečišćujućih tvari iz OVM

Uklanjanje suspendiranih tvari OVM provelo se postupcima taloženja i filtracije. Taloženje se provelo u Immhoff-ovom lijevku ukupnog volumena 1 dm^3 . Bistri dio se dekantirao i filtrirao kroz naborani filter papir veličine pora od 12 - 14 μm . Dobiveni filtrat koristio se u daljnjim ispitivanjima.

Adsorpcija fenola i organskih tvari iz OVM na različite adsorbense

Adsorpcija fenola i organskih tvari iz OVM-a na odabranim adsorbensima, aktivni ugljik, modificirana komina masline i kora banane, ispitana je u diskontinuiranim uvjetima rada, pokus P1. Masa adsorbensa iznosila je 0,5 g, a volumen otpadne vode 50 cm³. Pokusi, P1-I, P1-II i P1-III, provedeni su na termostatiranoj rotacijskoj tresilici pri 25 °C i brzini okretaja 180 o min⁻¹ tijekom 24 sata (tablica 1.). U određenom vremenskom intervalu iz tikvica izuzimani su određeni alikvoti, filtrirani kroz Sartorius membranski filter (pore 0,45 μm) te su spektrofotometrijski praćene koncentracije fenola te KPK vrijednosti.

Tablica 1. Početne vrijednosti za pokus P1
Table 1. The initial values of experiment P1

	POKUS P1		
	P1-I	P1-II	P1-III
Adsorbens	Aktivni ugljik	Modificirana komina maslina	Kora banane
pH / -	5,50	3,04	5,71
λ / mS cm ⁻¹	2,79		
γ_0 (fenoli) / mg dm ⁻³	57		
γ_0 (KPK - vrijednost) / mg O ₂ dm ⁻³	7.977		

Adsorpcija fenola i organskih tvari na aktivni ugljik pri različitim početnim koncentracijama fenola i KPK vrijednosti

U pokusu P2 provedena je adsorpcija fenola i organskih tvari na aktivni ugljik pri različitim početnim koncentracijama OVM u diskontinuiranim uvjetima rada. Masa aktivnog ugljika iznosila je 5 g, a volumen otpadne vode 100 cm³. Pokusi, P2-I, P2-II, P2-III, P2-IV, P2-V i P2-VI, provedeni su na termostatiranoj rotacijskoj tresilici pri 25 °C i brzini okretaja 180 o min⁻¹ tijekom 7 sati (tablica 2.). U određenom vremenskom intervalu iz tikvica izuzimani su određeni alikvoti, filtrirani kroz Sartorius membranski filter (pore 0,45 μm) te su spektrofotometrijski praćene koncentracije fenola te KPK vrijednosti.

Tablica 2. Početne vrijednosti za pokus P2
Table 2. The initial values of experiment P2

	POKUS P2					
	P2-I	P2-II	P2-III	P2-IV	P2-V	P2-VI
pH / -	6,94	5,80	5,54	5,45	4,93	4,78
λ / mS cm ⁻¹	1,48	3,80	7,25	5,50	8,82	11,96
γ_0 (fenoli) / mg dm ⁻³	22	34	59	80	189	238
γ_0 (KPK - vrijednost) / mg O ₂ dm ⁻³	4.112	8.130	13.939	18.740	28.135	35.955

Zaštita okoliša / Environmental Protection

Uzgojanje micelijskih zrnaca plijesni Aspergillus niger i Stachybotrys sp.

Iz izoliranih i čistih kultura plijesni, *Aspergillus niger* i *Stachybotrys* sp, iz OVM uzgojila su se micelijska zrnca u svrhu provođenja biosorpcije. Podloga za uzgoj micelijskih zrnaca plijesni priređena je otapanjem 140 g saharoze, 2,50 g KH_2PO_4 , 0,25 g $\text{MgSO}_4 \times 7\text{H}_2\text{O}$, 2,50 g NH_4NO_3 u litri demineralizirane vodi u koju je dodano 1 cm^3 prethodno priređenih otopina $\text{CuSO}_4 \times 5\text{H}_2\text{O}$ ($0,024 \text{ g} / 100 \text{ cm}^3$ demineralizirane vode), $\text{ZnSO}_4 \times 7\text{H}_2\text{O}$ ($0,110 \text{ g} / 100 \text{ cm}^3$ demineralizirane vode) te $\text{FeCl}_3 \times 6\text{H}_2\text{O}$ ($0,200 \text{ g} / 100 \text{ cm}^3$ demineralizirane vode). Priređene podloge volumena 100 cm^3 pipetirane su u Erlenmeyer tikvice i sterilizirane 30 minuta pri 0,5 atp i $110 \text{ }^\circ\text{C}$. U sljedećem koraku pripravljena je suspenzija spora plijesni, a broj spora odredio se pomoću Thomine komorice, koji je iznosio $2,6 \times 10^6 \text{ st cm}^{-3}$. U prethodno priređenu podlogu inokulirano je 1 cm^3 dobro homogenizirane suspenzije spora. Erlenmeyer tikvice u kojima je bila podloga s inokuliranim sporama plijesni postavljene su na termostataranu rotacijsku tresilicu pri 160 o min^{-1} , tijekom 24 - 48 sati.

Biosorpcija fenola i organskih tvari iz OVM na micelijska zrnca Aspergillus niger i Stachybotrys sp.

U pokusu P3 provedena je biosorpcija fenola i organskih tvari iz OVM na prethodno uzgojena micelijska zrnca *Aspergillus niger* i *Stachybotrys* sp. u diskontinuiranim uvjetima rada. Masa biosorbensa iznosila je 1 g_{VT} (vlažna tvar), odnosno $0,0269 \text{ g}_{\text{ST}}$ (suha tvar) za *Aspergillus niger* i $0,0686 \text{ g}_{\text{ST}}$ (suha tvar) za *Stachybotrys* sp., a volumen otpadne vode 100 cm^3 . Veličina peleta kulture *Aspergillus niger* bila je od 4 – 7 mm, a *Stachybotrys* sp. < 2 mm. Pokusi, P3-I i P3-II, provedeni su na termostataranoj rotacijskoj tresilici pri $25 \text{ }^\circ\text{C}$ i brzini okretaja 180 o min^{-1} tijekom 3 sata (tablica 3). U određenom vremenskom intervalu iz tikvica izuzimani su određeni alikvoti primjenjujući sterilnu tehniku rada, filtrirani kroz Sartorius membranski filter (pore $0,45 \text{ }\mu\text{m}$) te je spektrofotometrijski praćena boja te koncentracije fenola i KPK vrijednosti.

Tablica 3. Početne vrijednosti za pokus P3
Table 3. The initial values of experiment P3

	POKUS P3	
	P3-I	P3-II
Biosorbens	<i>Aspergillus niger</i>	<i>Stachybotrys</i> sp.
pH / -	5,09	
Boja / -	1,45	
γ_0 (fenoli) / mg dm^{-3}	51	
γ_0 (KPK - vrijednost) / $\text{mg O}_2 \text{ dm}^{-3}$	6.638	

Biosorpcija fenola i organskih tvari na micelijska zrnca Aspergillus niger pri različitim početnim koncentracijama fenola i KPK vrijednosti

U pokusu P4 provedena je biosorpcija i biorazgradnja fenola i organskih tvari iz OVM, pri različitim početnim koncentracijama OVM na micelijska zrnca *Aspergillus niger* u diskontinuiranim uvjetima rada. Masa biosorbensa iznosila je 2 g_{VT} odnosno $0,0538 \text{ g}_{\text{ST}}$, veličine peleta 5 – 7 mm, a volumen otpadne vode iznosio je 200 cm^3 .

Pokusi, P4-I, P4-II i P4-III, provedeni su na termostatiranoj rotacijskoj tresilici pri 25 °C i brzini okretaja 180 o min⁻¹ tijekom 72 sata (tablica 4). U određenom vremenskom intervalu iz tikvica izuzimani su određeni alikvoti primjenjujući sterilnu tehniku rada, filtrirani kroz Sartorius membranski filter (pore 0,45 µm) te je spektrofotometrijski praćena boja te koncentracije fenola i KPK vrijednosti.

Tablica 4. Početne vrijednosti za pokus P4
Table 4. The initial values of experiment P4

	POKUS P4		
	P4-I	P4-II	P4-III
pH / -	4,66	4,69	4,94
Abs (boja) / -	0,33	0,69	0,61
γ_0 (fenoli) / mg dm ⁻³	13	15	25
γ_0 (KPK - vrijednost) / mg O ₂ dm ⁻³	1.380	1.868	2.574

Rezultati i rasprava

Fizikalno-kemijska i mikrobiološka karakterizacija OVM

Prije samog postavljanja pokusa adsorpcije i biosorpcije provedena je fizikalno-kemijska karakterizacija OVM. Prema literaturi (Morillo i sur., 2009; Paredes i sur., 1997) te iz tablice 5. može se vidjeti da OVM karakterizira niska pH vrijednost, visoka električna vodljivost, visoka koncentracija suspendiranih tvari, KPK vrijednosti i fenola. Svi ti pokazatelji ukazuju da je OVM izrazito opterećena organskom tvari i da se kao takva ne smije ispustiti u sustav javne odvodnje.

Tablica 5. Fizikalno kemijska karakterizacija OVM
Table 5. Physical and chemical characteristics of OVM

pH / -	λ / mS cm ⁻¹	γ (fenoli) / mg dm ⁻³	γ (KPK - vrijednost) / mg O ₂ dm ⁻³	γ (suspendirane tvari) / g dm ⁻³
4,94	11,54	370	62.640	12,55

Mikrobiološkom analizom utvrđen je ukupan broj bakterija i gljiva koji je iznosio $4,2 \times 10^3$ st cm⁻³ odnosno $1,9 \times 10^7$ st cm⁻³, od toga je $1,56 \times 10^7$ st cm⁻³ kvasaca, a $3,4 \times 10^6$ st cm⁻³ plijesni. Navedeni rezultati ukazuju da je OVM dobar medij za rast gljiva, odnosno plijesni i kvasca, zbog niske pH vrijednost OVM (tablica 5.) što pogoduje aktivnosti kvasaca i plijesni (Dąbrowski, 2001; Gracia i sur., 2000). Nadalje, otpadne vode iz proizvodnje maslinovog ulja sadrže šećere koji pogoduju rastu gljiva, jer su otpornije na osmotski tlak od bakterija, pa mogu rasti u okolišu s velikom koncentracijom šećera (Paredes i sur., 1997). Kulture iz OVM koje su izrasle na sladnom agaru i koje prevladavaju (dvije plijesni i dva kvasca) izolirane su i podvrgnute daljnjoj identifikaciji kako bi se utvrdilo o kojem se kvascu odnosno plijesni radi. Kvasci su identificirani API stripom te očitavanjem biokemijskog profila API stripa utvrđeno je kako se radi o kulturama

Zaštita okoliša / Environmental Protection

Cryptococcus neoformans (95 % uspješna identifikacija) te *Candida guilliermondi* (98 % uspješna identifikacija). Kultura *Cryptococcus neoformans* na hranjivoj podlozi tvori kolonije mliječno bijele boje okruglog oblika, nepravilnog ruba i ispupčenog rasta. Kultura *Candida guilliermondii* na hranjivoj podlozi također tvori kolonije mliječno bijele boje, sluzave i sjajne površine te okruglog do jajolikog oblika. Karakteristika ove kulture je da tvori pseudo-hife.

Mikroskopskim pregledom i utvrđivanjem morfoloških karakteristika izolirane kulture plijesni su *Aspergillus niger* i *Stachybotrys* sp. (Sl. 1). *Aspergillus niger* je najpoznatija vrsta plijesni iz roda *Aspergillus*. Osnovna morfološka karakteristika je neseptirana hifa i glavica iz koje zrakasto rastu miceliji na kojima se nalaze spore crne boje. *Stachybotrys* sp. karakterizira plavkasto zelenkasta boja te konidiofori koji tvore metule na kojima se nalaze sterigme i lanci konidiospora (Duraković, 1996). Identificirane kulture kvasaca i plijesni su prema literaturi identificirane u OVM i u drugim istraživanjima (Fadil i sur., 2003; Lasaridi i sur., 2010).

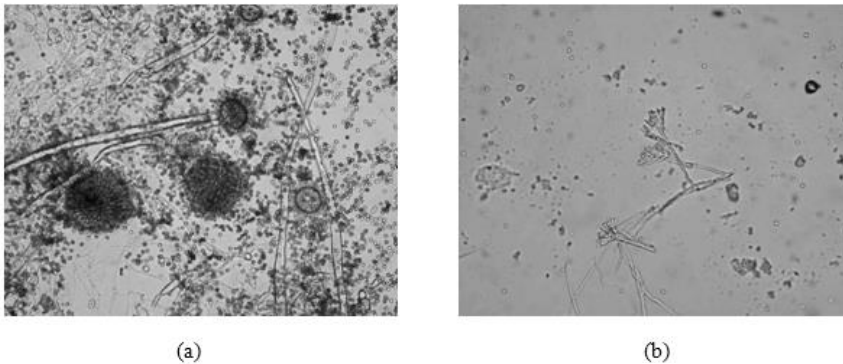

Slika 1. Mikrofotografija stanica *Aspergillus niger* (a) i *Stachybotrys* sp.(b), P = 400×
 Fig. 1. Microphotography of cultures *Aspergillus niger* (a) i *Stachybotrys* sp.(b), P = 400×

Postupci provedenih ispitivanja

Kako bi se uklonile suspendirane tvari iz OVM, provedeni su postupci taloženja i filtracije (Al-Farraj i sur., 2013; Azzam i sur., 2010), a rezultati su prikazani u tablici 6. Iz tablice 5. vidljivo je kako je koncentracija suspendiranih tvari vrlo visoka i iznosi $12,55 \text{ g dm}^{-3}$, a nakon provedenog postupka taloženja koncentracija se smanjila na $1,46 \text{ g dm}^{-3}$, odnosno za 88,37 %. Nadalje, koncentracija fenola se smanjila za 28,38 %, a KPK vrijednost za 27,60 %.

Tablica 6. Fizikalno-kemijska karakterizacija OVM nakon predobrade OVM
 Table 6. Physical and chemical characteristics of OVM after pretreatment

Postupci predobrade OVM	γ (KPK - vrijednost) / $\text{mg O}_2 \text{ dm}^{-3}$	γ (fenoli) / mg dm^{-3}	γ (suspendirane tvari) / g dm^{-3}	pH / -	λ / mS cm^{-1}
Taloženje	45.350	265	1,46	5,03	11,54
Filtracija	36.780	260	0,66	5,15	

Postupak filtracije rezultirao je dodatnim uklanjanjem suspendirane tvari sa $1,46 \text{ g dm}^{-3}$ na $0,66 \text{ g dm}^{-3}$, odnosno za 54,79 %. Koncentracija fenola nije se značajno promijenila nakon filtracije u odnosu na taloženje, dok KPK vrijednost se smanjila sa $45.350 \text{ mg O}_2 \text{ dm}^{-3}$ na $36.780 \text{ mg O}_2 \text{ dm}^{-3}$, odnosno za 18,90 %. Provedena je adsorpcija fenola i organske tvari izražene kao KPK vrijednost iz OVM na različite adsorbense, aktivni ugljik (P1-I), modificiranu kominu masline (P1-II) i koru banane (P1-III). Promjena koncentracije fenola i KPK vrijednosti praćena je 24 sata. Iz slike 2 vidljivo je kako aktivni ugljik učinkovito uklanja fenole, 47 %, dok kora banane 23 %, a modificirana komina masline manje od 15 %. Prema istraživanju Achack i sur. (2009) kora banane adsorbirala je 34 % fenola iz OVM nakon 24 sata. Nadalje, prema nekim istraživanjima komina masline i modificirana komina masline učinkovito uklanjaju fenole, dok prema nekima komina masline ne uklanja nego otpušta fenole koje sadrži (Stasinakis i sur., 2008). Prema istraživanju Stasinakisa i sur. (2008) modificirana komina masline, pri masi od 1 g dm^{-3} adsorbensa, uklanja oko 18 % fenola iz OVM. Također, iz Sl. 2 može se vidjeti da se vrijednost KPK smanjila za 37,5 % primjenom aktivnog ugljika, odnosno za 12,5 % primjenom modificirane komine maslina. Vrijednost KPK se nije smanjivala tijekom vremena s obzirom na početnu koncentraciju prilikom adsorpcije na koru banane, već je neznatno porasla zbog otapanja nekih organskih tvari koje su prisutne u i na kori banane, npr. pesticidi, što je u skladu s drugim istraživanjima (Achack i sur., 2009). U pokusu P2 ispitivana je adsorpcija fenola i organske tvari izražene kao KPK vrijednost iz OVM na aktivni ugljik pri različitim početnim koncentracijama fenola i organske tvari (P2-I do P2-VI). U Sl. 3 (a) i (b) prikazan je utjecaj trajanja procesa na adsorpciju fenola i organske tvari izražene kao KPK vrijednost na aktivni ugljik. U prvih 30 min se adsorbirala najveća koncentracija fenola (oko 50 %) i organske tvari (oko 30 %) na aktivni ugljik u pokusima P2-V i P2-VI. U pokusima P2-I do P2-IV koncentracija fenola se smanjivala prvih 240 minuta te se do kraja procesa nije mijenjala, dok KPK vrijednost se ustalila nakon 60 minuta. Adsorpcija je na početku procesa bila izražena zbog velikog broja slobodnih adsorpcijskih mjesta na površini adsorbensa (Öztürk i sur., 2005) te se s vremenom usporavala.

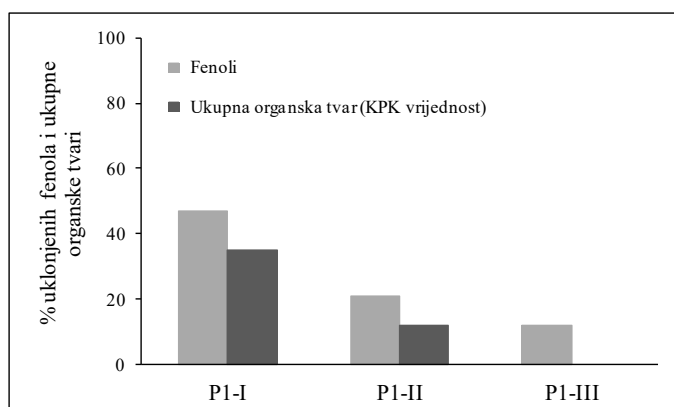

Slika 2. Postotak uklonjenih fenola i ukupnog organskog opterećenja izraženog preko KPK vrijednosti u pokusu P1 nakon 120 minuta ($m = 0,5 \text{ g}$, $V = 50 \text{ cm}^3$, $T = 25 \text{ °C}$ i 180 o min^{-1})

Fig. 2. Percentage of removed phenols and organic matter in experiment P1 after 120 minutes ($m = 0,5 \text{ g}$, $V = 50 \text{ cm}^3$, $T = 25 \text{ °C}$ i 180 o min^{-1})

Zaštita okoliša / Environmental Protection

Uspostavljanje adsorpcijske ravnoteže fenola i organske tvari analizirano je primjenom Freundlichovog i Langmuirovog modela u ispitivanom koncentracijskom području od 20 do 240 mg dm⁻³, odnosno od 4.000 do 36.000 mg dm⁻³. Vrijednosti, K_F , K_L , n , q_{max} i R^2 za aktivni ugljik prilikom adsorpcije fenola i organske tvari dane su u tablici 7. Parametri Langmuirove i Freundlichove izoterme procijenjeni su nelinearnom regresijom metodom najmanjih kvadrata u programskom paketu *Scientist*. Iz dobivenih rezultata vidljivo je da se eksperimentalni rezultati (fenoli i KPK vrijednost) nešto lošije slažu s podacima izračunatim na temelju Freundlichovog modela, u odnosu na Langmuirov model, a na to ukazuje i izračunata R^2 vrijednost (tablica 7.)

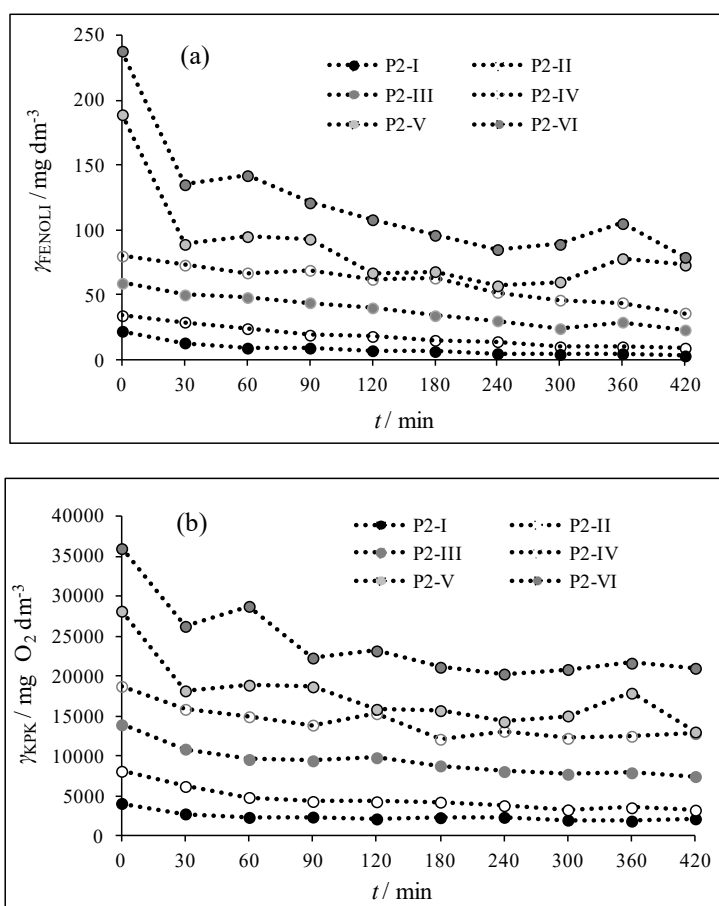

Slika 3. Promjena koncentracije fenola (a) i KPK vrijednosti (b) tijekom sedam sati u pokusu P2 ($m = 5$ g, $V = 100$ cm³, $T = 25$ °C i 180 o min⁻¹)

Fig. 3. The change of concentration of phenols (a) and COD (b) during seven hours in experiment P2 ($m = 5$ g, $V = 100$ cm³, $T = 25$ °C i 180 o min⁻¹)

Tablica 7. Vrijednosti adsorpcijskih konstanta dobivenih iz Langmuirove i Freundlichove izoterme pri adsorpciji fenola i organske tvari izražene kao KPK vrijednost na aktivni ugljik

Table 7. Langmuir and Freundlich isotherm constants for adsorption of phenols and organic matter expressed as COD on activated carbon)

Adsorpcijska izoterma	Parametri	Onečišćujuća tvar	
		Fenol (mg dm ⁻³)	Organska tvar (KPK vrijednost / mg O ₂ dm ⁻³)
Langmuir	$q_{max} / \text{mg g}^{-1}$	2,338	376,140
	$K_L / \text{dm}^3 \text{mg}^{-1}$	0,052	$1,866 \cdot 10^{-5}$
	$R^2 / -$	0,855	0,862
Freundlich	$K_F / -$	0,0328	0,018
	$n / -$	1,379	1,468
	$R^2 / -$	0,799	0,848

Prema postupku opisanom u materijalima i metodama uzgojena su micelijska zrnca kultura plijesni *Aspergillus niger* i *Stachybotrys* sp. izoliranih iz OVM. Promjer uzgojenih micelijskih zrnaca *Aspergillus niger* iznosio je 4 – 7 mm, a *Stachybotrys* sp. < 2 mm (Sl. 4). Vrijeme potrebno za uzgoj micelijskih zrnaca jedan je od značajnih čimbenika koji određuje njihovu veličinu, odnosno što se duže uzgajaju to su veći. Prema literaturi promjeri micelijskih zrnaca približnih vrijednosti pokazali su dobru biosorpciju fenola i ostalih onečišćujućih tvari (Briški i sur., 1994; Furač i sur., 1994; Petrović i sur., 1993).

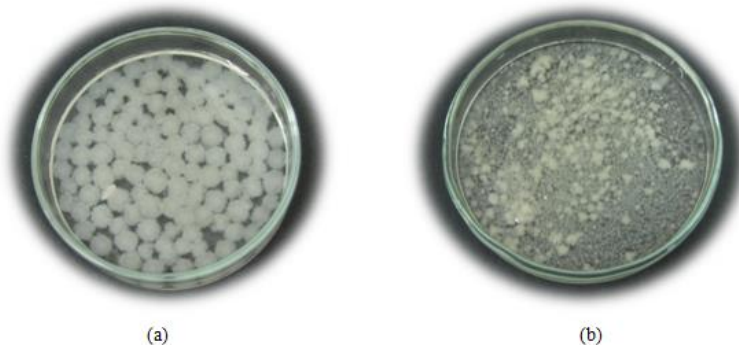

Slika 4. Uzgojena micelijska zrnca kultura *Aspergillus niger* (a) i *Stachybotrys* sp. (b)

Fig. 4. The grown pellets of *Aspergillus niger* (a) i *Stachybotrys* sp. (b)

U pokusu P3 ispitana je biosorpcija fenola, organskih tvari izražene kao KPK vrijednost te boje iz OVM na micelijska zrnca *Aspergillus niger* (P3-I) i *Stachybotrys* sp. (P3-II). Micelijska zrnca *Aspergillus niger* uklanjaju 41 % više fenola nego micelijska zrnca *Stachybotrys* sp. (Sl. 5). Micelijska zrnca *Stachybotrys* sp. (P3-II) ne uklanjaju organske tvari za razliku od micelijskih zrnca *Aspergillus niger* (P3-I).

Zaštita okoliša / Environmental Protection

Micelijska zrnca *Aspergillus niger* pokazuju smanjenje KPK vrijednosti za 13 % tijekom 60 minuta, a izraziti pad koncentracije od 34 % uočava se u vremenu od 90-te do 180-te minute. Promjena apsorbance boje u uzorku OVM prikazana je u Sl. 5, a u Sl. 6 usporedba micelijskih zrnaca *Aspergillus niger* prije i nakon procesa biosorpcije. Vidljivo je kako micelijska zrnca *Aspergillus niger* i *Stachybotrys* sp. biosorbiraju boju te je ukupno uklonjeno 38 % odnosno 7 % boje.

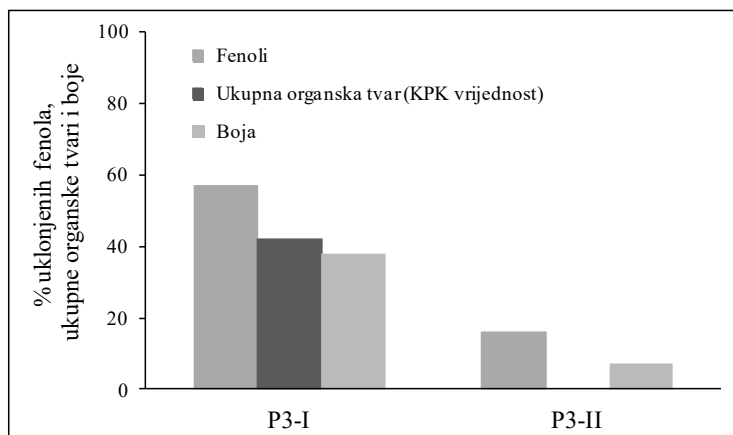

Slika 5. Postotak uklonjenih fenola, ukupnog organskog opterećenja izraženog preko KPK vrijednosti i boje nakon 180 minuta u pokusu P3
(m (vlažne tvari) = 1 g, $V = 100 \text{ cm}^3$, $T = 25 \text{ °C}$ i 180 o min^{-1})

Fig. 5. Percentage of removed phenols and organic matter in experiment P3 after 180 minutes
($m = 0,5 \text{ g}$, $V = 50 \text{ cm}^3$, $T = 25 \text{ °C}$ i 180 o min^{-1})

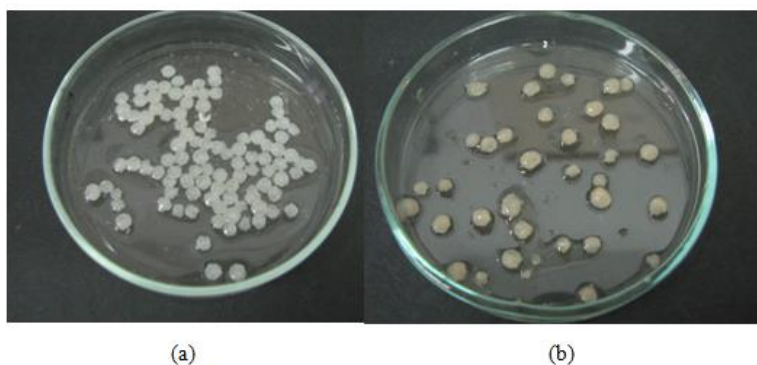

Slika 6. Micelijska zrnca -a prije (a) i nakon (b) procesa biosorpcije
Fig. 6. Pellets of *Aspergillus niger* before (a) and after (b) biosorption

U pokusu P4 ispitana je biosorpcija fenola i organskih tvari izražene kao KPK vrijednost iz OVM na micelijska zrnca *Aspergillus niger* pri različitim početnim koncentracijama fenola i organske tvari (P4-I, P4-II i P4-III) tijekom 72 sata. Uspostavljanje biosorpcijske ravnoteže fenola i organske tvari za micelijska zrnca *Aspergillus niger* analizirano je primjenom Freundlichovog i Langmuirovog modela u ispitivanom koncentracijskom području od 13 do 51 mg dm⁻³, odnosno od 1.000 do 6.500 mg dm⁻³ (tablica 8). Dobiveni rezultati ukazuju na gotovo jednako slaganje s Freundlichovim i Langmuirovim modelom, što potvrđuje i izračunata R² vrijednost. Maksimalni biosorpcijski kapacitet za micelijska zrnca *Aspergillus niger* prilikom biosorpcije fenola odnosno organske tvari iznosio je 138 mg g⁻¹ odnosno 3.206 mg g⁻¹.

Tablica 8. Vrijednosti adsorpcijskih konstanta dobivenih iz Langmuir i Freundlichove izoterme pri biosorpciji fenola i organske tvari izražene kao KPK vrijednost na micelijska zrnca *Aspergillus niger*

Table 8. Langmuir and Freundlich isotherm constants for biosorption of phenols and organic matter expressed as COD on pellets of *Aspergillus niger*)

Adsorpcijska izoterma	Parametri	Onečišćujuća tvar	
		Fenol (mg dm ⁻³)	Organska tvar (KPK vrijednost / mg O ₂ dm ⁻³)
Langmuir	$q_{max} / \text{mg g}^{-1}$	138,310	3.206,031
	$K_L / \text{dm}^3 \text{mg}^{-1}$	$2,796 \cdot 10^{-2}$	$3,456 \cdot 10^{-3}$
	R ² / -	0,997	0,981
Freundlich	$K_F / -$	3,461	0,970
	$n / -$	1,500	1,451
	R ² / -	0,999	0,988

Na Sl 7. prikazana je usporedba micelijskih zrnaca prije i nakon procesa biosorpcije. Iz slike se može vidjeti da su peleti nakon biosorpcije tamniji što ukazuje na sorbiranu boju iz OVM.

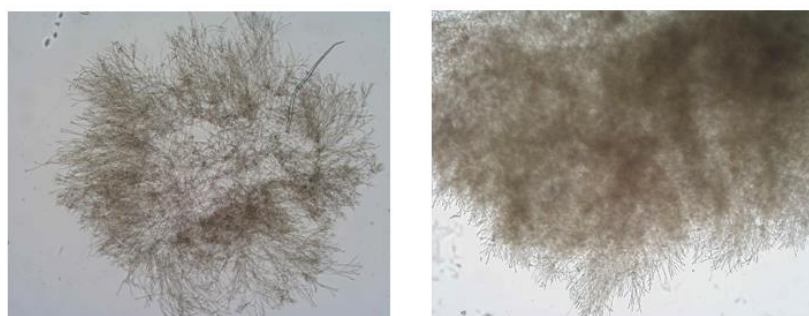

(a)

(b)

Slika 7. Mikrofotografija micelijskog zrna *Aspergillus niger* prije (a) i nakon (b) procesa biosorpcije

Fig. 7. Microphotography of pellets of *Aspergillus niger* before (a) and after (b) biosorption

Zaključci

Otpadna voda nastala tijekom proizvodnje maslinovog ulja (OVM) je jako opterećena organskim tvarima, fenolima, ima nisku pH vrijednost i visoku vodljivost te je obojana i kao takva se ne smije ispustiti u vodeni okoliš. U cilju uklanjanja onečišćujućih tvari i/ili štetnih i toksičnih tvari iz otpadne vode provela se remedijacija OVM postupcima adsorpcije i biosorpcije. Na temelju provedenih eksperimenata mogu se izvesti sljedeći zaključci:

(1) Predobradom OVM postupcima taloženja i filtracije suspendirana tvar, fenoli i KPK vrijednost su se smanjili za 95 %, 28 % odnosno za 41 %.

(2) Rezultati istraživanja procesa adsorpcije u diskontinuiranim uvjetima rada pokazuju da je aktivni ugljik uklonio 58 % fenola i 24 % organske tvari, kora banane 40 % fenola i 0 % organske tvari, a modificirana komina masline 23 % fenola i 13 % organske tvari unutar 24 sata. Određivanje parametara ravnotežne adsorpcije fenola i organske tvari izražene kao KPK vrijednost na aktivni ugljik provedeno je usporedbom eksperimentalnih rezultata s teorijskim vrijednostima dobivenim primjenom Langmuirovog i Freundlichovog modela. Najbolje slaganje dobiveno je primjenom Langmuirovog modela. Adsorpcijski kapacitet aktivnog ugljika prilikom adsorpcije fenola i organske tvari iznosio je 2,38 mg g⁻¹ odnosno 376 mg g⁻¹.

(3) Rezultati istraživanja procesa biosorpcije u diskontinuiranim uvjetima rada pokazuju da su micelijska zrnca *Aspergillus niger* uklonili 43 % fenola, 42 % organske tvari i 38 % boje, a *Stachybotrys* sp. 19 % fenola, 0 % organske tvari i 7 % boje. Određivanje parametara ravnotežne biosorpcije fenola i organske tvari izražene kao KPK vrijednost na micelijska zrnca *Aspergillus niger* provedeno je usporedbom eksperimentalnih rezultata s teorijskim vrijednostima dobivenim primjenom Langmuirovog i Freundlichovog modela koji podjednako dobro opisuju proces biosorpcije. Biosorpcijski kapacitet micelijskog zrnca *Aspergillus niger* prilikom biosorpcije fenola i organske tvari iznosio je 138 mg g⁻¹ odnosno 3206 mg g⁻¹.

Literatura

- Achak, M., Hafidi, A., Ouazzani, N., Sayadi, S., Mandi, L. (2009): Low cost biosorbent "banana peel" for the removal of phenolic compounds from olive mill wastewater: Kinetic and equilibrium studies, *J. Hazard. Mater.* 66, 117-125.
- Akar, T., Tosun, I., Kaynak, Z., Ozkara, E., Yeni, O., Sahin, E.N., Akar, S.T. (2009): An attractive agro-industrial by-product in environmental cleanup: Dye biosorption potential of untreated olive pomace, *J. Hazard. Mater.* 166, 1217-1225.
- Al-Farraj, A.S., Al-Sewailem, M.S., Anwar, A.A., Al-Wabel, M.I., El-Maghraby, S.E. (2013): Assessment and heavy metals behaviors of industrial wastewater on Riyadh City, Saudi Arabia, *Proc. Int. Acad. Ecol. Environ. Sci.* 3, 266-277.
- Azzam, M.O., Al-Malah, K., Al-Gazzawi, Z., Al-Omari, S.A. (2010): Dynamic treatment response of olive mills wastewater using series of adsorption steps, *Clean* 38 (9), 822-830.
- Ben Sassi, A., Ouazzani, N., Walker, G.M., Ibsouda, S., El Mzibri, M., Boussaid, A. (2008): Detoxification of olive mill wastewaters by Moroccan yeast isolates, *Biodegradation* 19, 337-346.

- Bleve, G. et al. (2011): *Selection* of non-conventional yeasts and their use in immobilized form for the bioremediation of olive oil mill wastewaters, *Bioresurce. Technol.* 102, 982-989.
- Briški, F., Petrović, M., Macan – Kaštelan, M., Sipos, L. (1994): Removal of humic substances from aqueous solution by fungal pellets, *Biocatalysis.* 10, 1-14.
- Dąbrowski, A. (2001): Adsorption – from theory to practice, *Adv. Colloid. Interfac.* 93, 135–224.
- Duraković, S. (1996): Opća mikrobiologija, Zagreb, Prehrambeno-tehnološki inženjering, pp. 226-229.
- El Hajjouji, H., El Fels, L., Pinelli, E., Barje, F., El Asli, A., Merlina, G., Hafidi, M. (2014): Evaluation of an aerobic treatment for olive mill wastewater detoxification, *Environ. Technol.* 35, 3052-3059.
- Fadil, K., Chahlaoui, A., Ouahbi, A., Zaid, A., Borja, R. (2003): Aerobic biodegradation and detoxification of wastewaters from the olive oil industry, *Int. Biodeterior. Biodegradation* 51, 37-41.
- Furač, L., Čurković, L., Briški, F., Heidemarie, M. (1994): Uklanjanje teških metala iz vodene otopine s micelijskim zrcima *Aspergillus niger*, In: Znanstveni skup: Metali u hrani i okolišu, Grgić, Z. (ed.), Stubičke Toplice, HR, pp. 296.
- Garcia, I.G. et al. (2000): Removal of phenol compounds from olive mill wastewater using *Phanerochaete chrysosporium*, *Aspergillus niger*, *Aspergillus terreus* and *Geotrichum candidum*, *Process. Biochem.* 35, 751-758.
- Hui, L., Yu, Q.J., Wang, G., Ye, F., Cong, Y. (2011): Biodegradation of phenol at high concentration by a novel yeast *Trichosporon montevidense* PHE1, *Process. Biochem.* 46, 1678-1681.
- Jurac, Z. (2009): Otpadne vode, Karlovac, Veleučilište u Karlovcu, pp. 25-39.
- Lasaridi, K.E. et al. (2010): *Estimating the bioremediation of green table olive processing wastewater using a selected strain of Aspergillus niger*, *Desalin. Water. Treat.* 23, 26-31.
- Mann, J. et al. (2008): *Bioremediation of olive mill wastewater with selected filamentous fungi*. In: 4th BioRemediation Conference, Fava, F. (ed.), Chaina, GR, 2008.
- Morillo, J.A. et al. (2009): Bioremediation and biovalorisation of olive-mill wastes, *Appl. Microbiol. Biotechnol.* 82, 25-39.
- Öztürk, N., Kavak, D. (2005): Adsorption of boron from aqueous solutions using fly ash: Batch and column studies, *J. Hazard. Mater.* B127, 81-88.
- Paredes, C. et al. (1997): Characterization of olive-mill wastewater (alpechin) and its sludge for agricultural purposes, *Bioresurce. Technol.* 67, 111-115.
- Petrović, M., Briški, F., Macan – Kaštelan, M. (1993): Biosorption and biodegradation of humic substances by *Trichoderma viride*, *Prehrambeno – Tehnol. Biotehnol. rev.* 31 (4), 145-149.
- Standard methods for the examination of waste and wastewater, American public health association, 1999.
- Santi, C.A. et al. (2008): *Reduction of organic pollutants in Olive Mill Wastewater by using different mineral substances as adsorbents*, *Bioresurce. Technol.* 99, 1954-1951
- Stasinakis, A.S. et al. (2008): Removal of total phenols from olive-mill wastewater using an agricultural by-product, olive pomace, *J. Hazard. Mater.* 160, 408-413.
- Tušar, B. (2004): Ispuštanje i pročišćavanje otpadne vode, Zagreb, Croatia knjiga.

Original research paper

Olive mill wastewater treatment by adsorption and biosorption processes

Dajana Kučić*, Denija Krivičić, Felicita Briški

University of Zagreb, Faculty of Chemical Engineering and Technology,
Department of Industrial Ecology, Marulićev trg 19, HR-10000 Zagreb, Croatia

*Corresponding author: dkucic@fkit.hr

Summary

The activated carbon has removed 47 % of phenols and 38 % of organic load; bananas peel 23 % of phenols and 0 % of organic load and modified olive pomace 15 % of phenols and 13 % of the organic load within 2 hours. The fungal pellets of *Aspergillus niger* and *Stachybotrys* sp. have removed 43 % and 19 % of phenols, 42 % and 0 % of organic load and 38 % and 7 % of colour, respectively. The adsorption and biosorption capacity of the activated carbon and fungal pellets of *Aspergillus niger* during the adsorption and biosorption of phenols and organic load was 2,38 mg g⁻¹ and 376 mg g⁻¹, 138 mg g⁻¹ and 3.206 mg g⁻¹, respectively. The equilibrium modelling parameters of phenols and organic load (COD) on the activated carbon and on fungal pellets of *Aspergillus niger* were evaluated by comparison of experimental results and theoretical values of the Langmuir and Freundlich isotherm models. The equilibrium data were best represented by the Langmuir isotherm model during the adsorption of phenols and organic load on the activated carbon and the same value of regression coefficient was obtained for Langmuir and Freundlich isotherm model during biosorption on fungal pellets of *Aspergillus niger*.

Keywords: olive mill wastewater (OMW), phenols, adsorption, biosorption, Langmuir and Freundlich isotherm models

Izvorni znanstveni rad

Denitrifikacija: Učinak omjera C/N

Dijana Grgas¹, Tea Širac¹, Morena Prodan¹, Andrijana Brozinčević²,
Tibela Landeka Dragičević^{1*}

¹Sveučilište u Zagrebu, Prehrambeno-biotehnološki fakultet, Pierottijeva 6, 10000 Zagreb, Hrvatska

²Nacionalni park Plitvička jezera, Josipa Jovića 19, 53231 Plitvička jezera, Hrvatska

*Dopisni autor: tandekadragicevic@pbf.hr

Sažetak

Istražena je denitrifikacija 35 ± 2 mg $\text{NO}_3\text{-N/L}$ i 80 ± 2 mg $\text{NO}_3\text{-N/L}$ uz natrijev acetat kao izvor ugljika pri omjeru C/N 2, 3, i 4. Za potpunu denitrifikaciju minimalni potreban omjer je C/N 3. Određena je specifična brzina denitrifikacije i količina *KPK* potrebna za redukciju $\text{NO}_3\text{-N}$ (mg *KPK*/mg $\text{NO}_3\text{-N}$). U denitrifikaciji 35 ± 2 mg $\text{NO}_3\text{-N/L}$ omjer $\Delta\text{KPK}/\Delta\text{NO}_3\text{-N}$ je iznosio 5,8 (pri C/N 3) i 6,4 (pri C/N 4), a u denitrifikaciji 80 ± 2 mg $\text{NO}_3\text{-N/L}$ omjer $\Delta\text{KPK}/\Delta\text{NO}_3\text{-N}$ je iznosio 6,9 (pri C/N 3) i 7,9 (pri C/N 4). Brzina denitrifikacije 35 ± 2 mg $\text{NO}_3\text{-N/L}$ pri omjerima C/N 3 i 4 iznosi 64 mg $\text{NO}_3\text{-N/Lh}$, a brzina denitrifikacije 80 ± 2 mg $\text{NO}_3\text{-N/L}$ pri omjerima C/N 3 i 4 iznosi 44,7 mg $\text{NO}_3\text{-N/Lh}$ i 51,9 mg $\text{NO}_3\text{-N/Lh}$. Denitrifikacija sa limitiranim raspoloživim ugljikom – elektron donorom, pri C/N 2, rezultira nepotpunom redukcijom $\text{NO}_3\text{-N}$, postignuta je 58,5% i 55% redukcija $\text{NO}_3\text{-N}$ sa dodanim vanjskim izvorom ugljika u denitrifikaciji 35 ± 2 mg $\text{NO}_3\text{-N/L}$ odnosno 80 ± 2 mg $\text{NO}_3\text{-N/L}$. Denitrifikacija $\text{NO}_3\text{-N}$ je provedena s aktivnim muljem prilagođenim za proces denitrifikacije. U aktivnom mulju je primjenom *FISH* (fluorescence *in situ* hybridization) metode dokazano prisustvo denitrifikanata.

Gljučne riječi: denitrifikacija, acetat, omjer C/N

Uvod

Spojevi s dušikom, amonijak ($\text{NH}_4\text{-N}$), nitrat ($\text{NO}_3\text{-N}$) i nitrit ($\text{NO}_2\text{-N}$), kada dospiju u okoliš uzrokuju eutrofikaciju vodnih tijela, onečišćenje podzemnih voda, pridonose emisiji stakleničkih plinova i predstavljaju opasnost za zdravlje ljudi. Iz tog razloga, i sve strožih zakonskih regulativa (NN 03/2016; NN 080/2013), učinkovito uklanjanje N iz otpadne vode je jedan od prioriteta u istraživanju biološke obrade otpadnih voda (Xu i sur., 2011; Fernández -Nava i sur., 2010). Biološki procesi koji se uobičajeno koriste za uklanjanje N iz otpadne vode su nitrifikacija i denitrifikacija. Nitrifikacija je autotrofan aeroban proces u kojem se $\text{NH}_4\text{-N}$ prevodi u $\text{NO}_3\text{-N}$. Denitrifikacija je anoksičan proces u kojem heterotrofni denitrifikanti reduciraju $\text{NO}_3\text{-N}$ do plinovitog dušika, uz organske sastojke kao donore elektrona, koje koriste i za stanični rast (Pan i sur., 2012; Bernat i Wojnowska-Baryla, 2007). Denitrifikacija se odvija u četiri koraka: $\text{NO}_3\text{-N}$ se prevodi u $\text{NO}_2\text{-N}$ pomoću enzima nitrat reduktaze, $\text{NO}_2\text{-N}$ u NO pomoću nitrit reduktaze, NO u N_2O pomoću dušik (II) oksid reduktaze i N_2O u plinoviti N_2 pomoću dušik (I) oksid reduktaze (Pan i sur., 2012).

Organski sastojci koji mogu poslužiti kao donori elektrona su biorazgradivi organski sastojci izraženi kao *KPK* (Kemijska Potrošnja Kisika) otpadne vode, biorazgradivi *KPK* proizveden tijekom endogene respiracije i vanjski izvor ugljika (Srinandan i sur., 2012; Bernat i Wojnowska-Baryla, 2007; Constantin i Fick, 1997). Kada u otpadnoj vodi nema dovoljno biorazgradivih organskih sastojaka za denitrifikaciju, poput otpadnih voda niskog omjera *KPK/N*, ili kada su organski sastojci (*KPK*) uklonjeni iz otpadne vode u ranijim stupnjevima obrade, nužno je dodati vanjski izvor ugljika. U literaturi se kao povoljni izvori ugljika navode acetat, etanol, metanol, metan, glukoza, valerat, propionat i butirat (Hagman i sur., 2008). U endogenoj denitrifikaciji učinkovitost je niska zbog ograničene količine ugljika iz endogenog metabolizma (Tam i sur., 1992; Abufayed i Schroeder, 1986).

U anoksičnim uvjetima, ako nema rasta stanica, teoretska potreba za redukciju 1 mg $\text{NO}_3\text{-N}$ iznosi 2,86 mg *KPK* (Henze, 1991), međutim u praksi je za redukciju 1 mg $\text{NO}_3\text{-N}$ potrebno minimalno 3,5-4,5 mg *KPK*, a istraživanja ukazuju da je za učinkovitu denitrifikaciju potrebno 3-7 mg *KPK*/mg N. Učinkovitost denitrifikacije se povećava s porastom omjera C/N, dok previsok omjer C/N uzrokuje inhibiciju aktivnog mulja. Stoga je važno definirati omjer C/N pri kojem se postiže maksimalna učinkovitost, i da odgovara zahtjevima procesa (Her i Huang, 1995).

Brojna istraživanja o vanjskom izvoru ugljika kao elektronu donoru za denitrifikaciju pokazuju da se sa acetatom postiže najveća brzina denitrifikacije (Elefsiniotis i Wareham, 2007; Lee i Welander, 1996), jer acetat kao lako biorazgradivi izvor ugljika denitrifikanti izravno ugrađuju u Krebsov ciklus. Tijekom denitrifikacije često se nakuplja $\text{NO}_2\text{-N}$, a na akumulaciju utječu vrsta izvora ugljika, omjer C/N, pH, i najviše sastav denitrificirajuće zajednice u aktivnom mulju (Ge i sur., 2012; Oh i Silverstein, 1999; Glass i Silverstein, 1998). U istraživanju denitrifikacije uz acetat, glukozu, metanol i etanol kao vanjskih izvora ugljika pri omjeru C/N 2,5 (Srinandan i sur., 2012), primjenom acetata i glukoze je zabilježena gotovo 100% redukcija $\text{NO}_3\text{-N}$, a sa metanolom i etanolom redukcija $\text{NO}_3\text{-N}$ je izosila 72%, odnosno 61%. Također, rezultati su pokazali da je sa acetatom kao izvorom ugljika akumulacija $\text{NO}_2\text{-N}$ neznatna u usporedbi s drugim izvorima ugljika. Constantin i Fick (1997) su istraživali denitrifikaciju sa acetatom i etanolom kao izvorom ugljika i pokazali da se sa acetatom postiže veća specifična brzina denitrifikacije. Brian i sur. (2007) u pokusima denitrifikacije sa acetatom, metanolom i iskorištenom hranjivom podlogom kao izvorom ugljika su postigli najveću brzinu denitrifikacije sa acetatom kao donorom elektrona.

Budući da N igra veliku ulogu u mnogim ekosustavima, kao limitirajući nutrijent, od velike je važnosti razumijevanje denitrifikacije i čimbenika koji utječu na proces denitrifikacije (Rabalais, 2002; Vitousek i Howarth, 1991). Kako je denitrifikacija istražena na ograničenom broju organizama, neophodno je poznavanje aktivnosti, strukture i brojnosti denitrifikanata prisutnih u mulju da bi se postiglo učinkovito uklanjanje $\text{NO}_2\text{-N}$ i $\text{NO}_3\text{-N}$ iz otpadne vode (Shapleigh, 2006). Fluorescencija *in situ* hibridizacija (FISH) je molekularna metoda, neovisna o kultivaciji, koja se često primjenjuje za izravnu kvantifikaciju i identifikaciju ciljanih skupina mikroorganizama u okolišnim ili laboratorijskim uzorcima. FISH metoda se često koristi za analizu aktivnog mulja iz razloga što se većina stanica mogu lako detektirati pomoću univerzalnih proba (Amann, 1995).

Materijali i metode

Mikroorganizmi i supstrat

Aktivni mulj porijeklom iz postrojenja za biološku obradu otpadnih voda grada Velika Gorica, koji je u laboratorijskim uvjetima aklimatiziran na uklanjanje N iz otpadne vode uzastopnim pokusima nitrifikacije i denitrifikacije, uporabljen je u ovom istraživanju. Korištena je sintetska otpadna voda, priređena otapanjem soli (sve soli proizvod tvrtke Merck, Njemačka) u vodovodnoj vodi: 2 g/L $(\text{NH}_4)_2\text{SO}_4$; 1 g/L KH_2PO_4 ; 0,4 g/L FeSO_4 ; 0,5 g/L MgSO_4 ; 0,4 g/L NaCl ; 1 g/L MgCO_3 , 1 g/L CaCO_3 , koja je nakon stajanja 24 h na sobnoj temperaturi filtrirana kroz filter papir veličine pora 0,45 μm . Kao izvor ugljika korišten je bezvodni natrijev acetat ($\text{NaC}_2\text{H}_3\text{O}_2$), proizvod tvrtke Kemika, Hrvatska, Mr $\text{NaC}_2\text{H}_3\text{O}_2 = 82,03$ g/mol. Eksperimentalno je određeno da 1 g natrijeva acetata odgovara 0,55 g KPK (Kemijska Potrošnja Kisika).

Pokusi denitrifikacije

Pokusi denitrifikacije su vođeni šaržno u anoksičnim uvjetima, u laboratorijskim čašama radnog volumena 0,5 L, pri koncentraciji otopljenog kisika $< 0,5$ mg/L, miješanjem na magnetskoj miješalici (IKA RH basic 2) pri 100 o/min. Pokusi denitrifikacije su započeti dodatkom natrijevog acetata za odabrani omjer C/N ($\text{C}_{\text{NaC}_2\text{H}_3\text{O}_2}/\text{N}_{\text{NO}_3\text{-N}}$), a $\text{NO}_3\text{-N}$ kao supstrat u pokusima denitrifikacije je nakupljen tijekom prethodno provedene nitrifikacije pri čemu je sav $\text{NO}_x\text{-N}$ ($\text{NO}_2\text{-N} + \text{NO}_3\text{-N}$) bio u obliku $\text{NO}_3\text{-N}$. Pokusi denitrifikacije provedeni su pri sobnoj temperaturi, u triplikatu a rezultati su izraženi kao srednja vrijednost \pm SD, $p < 0,05$ (ANOVA). Tijekom pokusa motrene su vrijednosti pH, temperature i otopljenog kisika pomoću odgovarajućih elektroda i mjernih aparata (pH elektroda WTW SenTix 41 i mjerni aparat WTW 330i, i kisikova elektroda WTW DurOx i mjerni aparat WTW 3210 Oxi). Pokusi denitrifikacije 35 ± 2 mg $\text{NO}_3\text{-N/L}$ i 80 ± 2 mg $\text{NO}_3\text{-N/L}$ provedeni su s aklimatiziranim aktivnim muljem koncentracije $4,3 \pm 0,2$ g MLSS/L (eng. Mixed Liquor Suspendid Solids). Tijekom pokusa denitrifikacije periodično su uzimani uzorci za određivanje KPK, $\text{NO}_3\text{-N}$, $\text{NO}_2\text{-N}$ i MLSS prema Standardnim metodama (Standard Methods, 1998). Fluorescenija *in situ* hibridizacija analiza mikrobne populacije u pokusima denitrifikacije je napravljena prema Amann (1995). *FISH* uzorci su vizualizirani na konfokalnom laser skenirajućem mikroskopu (Leica). Korištene su 4 oligonukleotidne probe označene fluorescentnim bojama cianin 3 i cianin 5 (Tablica 1) (GOREA PLUS, Hrvatska). Uzorci mulja su uzeti na kraju pokusa denitrifikacije te analizirani *FISH* metodom za određivanje denitrifikanata u ukupnim bakterijama aktivnog mulja.

Tablica 1. Probe korištene za *FISH*

Table 1. Probes used for *FISH*

Naziv probe		Ciljana skupina	Sekvenca (5'-3')	Formamid, %	Literatura
DEN124		Denitri-fikanti	CGACATGGGCGCGTTCGAT	40	Ginige i sur. (2005)
EUB338	EUBmix	Sve bakterije	GCTGCCTCCCGTAGGAGT	0-50	Amann i sur. (1990)
EUB338-II			GCGCCACCCGTAGGTGT	0-50	Daims i sur. (1999)
EUB338-III			GCTGCCACCCGTAGGTGT	0-50	

Rezultati i rasprava

Istražen je učinak izvora ugljika odabranog omjera C/N 2, 3 i 4 na učinkovitost denitrifikacije i brzinu denitrifikacije s povećanjem opterećenja sa $\text{NO}_3\text{-N}$, uz natrijev acetat kao izvor ugljika (Slika 1). Acetat je odabran kao izvor ugljika jer se njegovom uporabom postižu velike brzine denitrifikacije. Denitrifikacija 35 ± 2 mg $\text{NO}_3\text{-N/L}$ i 80 ± 2 mg $\text{NO}_3\text{-N/L}$ je provedena s aklimatiziranim aktivnim muljem koncentracije $4,3 \pm 0,2$ g *MLSS/L*. Mikrobne reakcije kao odraz aktivnosti mikrobnih kultura u denitrifikaciji 35 ± 2 mg $\text{NO}_3\text{-N/L}$ su prikazane pri omjeru C/N 3 slikom 2, te slikom 3 za denitrifikaciju 80 ± 2 mg $\text{NO}_3\text{-N/L}$ pri omjeru C/N 3, koji predstavlja minimalan potreban omjer C/N za potpunu denitrifikaciju.

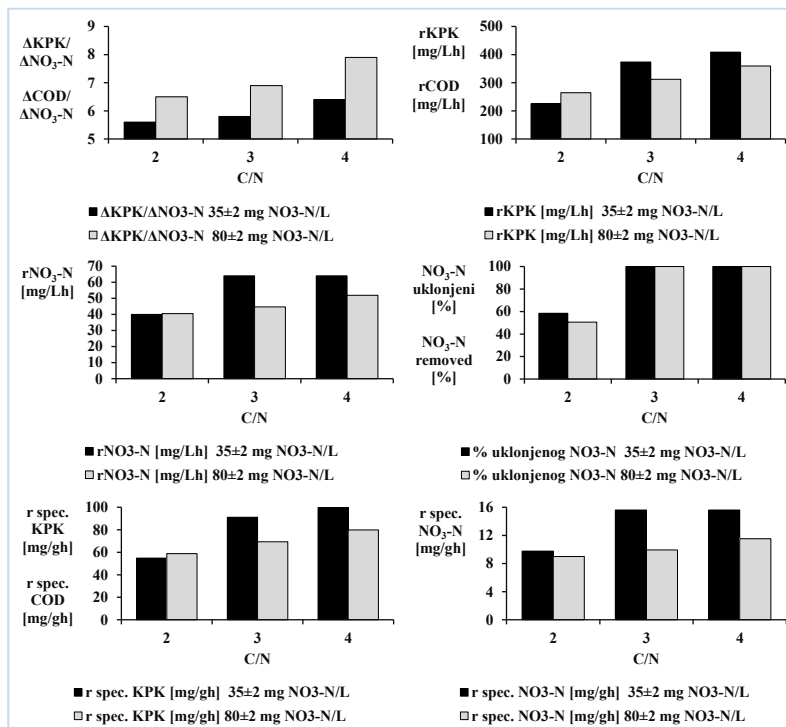

Slika 1. Usporedba utroška organskih sastojaka izraženih kao *KPK* za redukciju $\text{NO}_3\text{-N}$, brzine uklanjanja organskih sastojaka, brzine redukcije $\text{NO}_3\text{-N}$, količine uklonjenog $\text{NO}_3\text{-N}$, specifične brzine uklanjanja organskih sastojaka i specifične brzine uklanjanja $\text{NO}_3\text{-N}$, u denitrifikaciji 35 ± 2 mg $\text{NO}_3\text{-N/L}$ i 80 ± 2 mg $\text{NO}_3\text{-N/L}$

Fig. 1. The comparison of *COD* consumption for $\text{NO}_3\text{-N}$ reduction, *COD* removal rate, $\text{NO}_3\text{-N}$ reduction rate, the amount of $\text{NO}_3\text{-N}$ removed, specific *COD* removal rate, and specific $\text{NO}_3\text{-N}$ removal rate in denitrification of 35 ± 2 mg $\text{NO}_3\text{-N/L}$ and 80 ± 2 mg $\text{NO}_3\text{-N/L}$

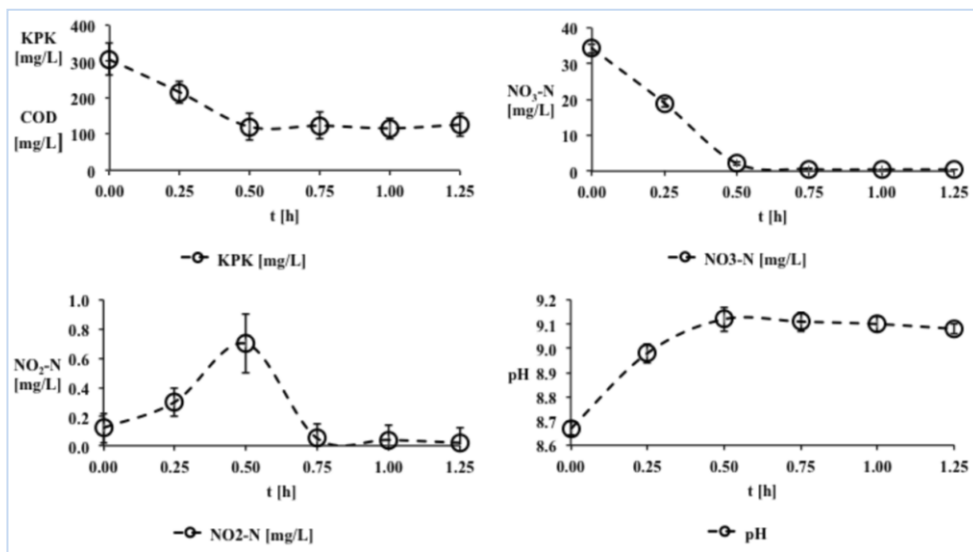

Slika 2. Denitrifikacija 35 ± 2 mg $\text{NO}_3\text{-N/L}$ pri omjeru C/N 3
 Fig. 2. Denitrification of 35 ± 2 mg $\text{NO}_3\text{-N/L}$ at ratio C/N 3

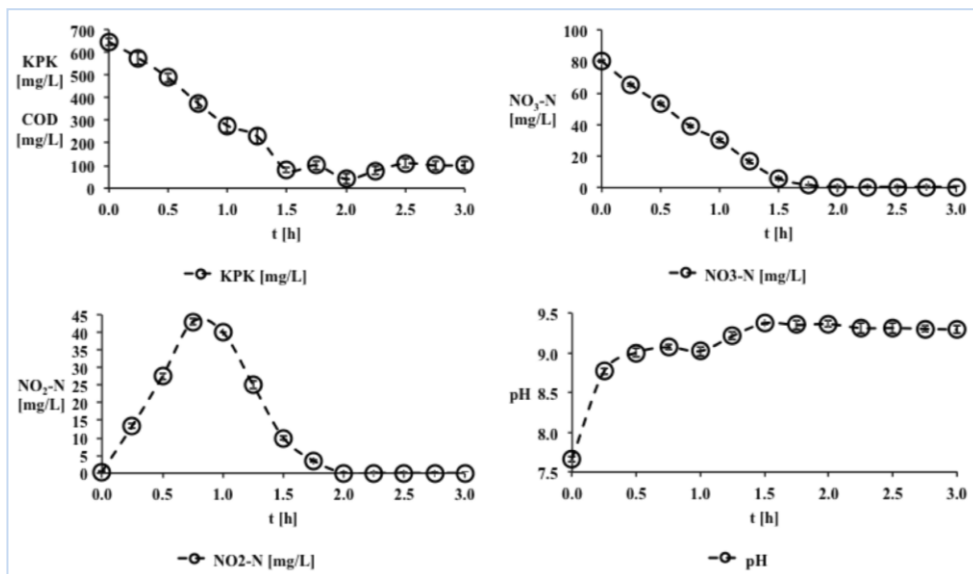

Slika 3. Denitrifikacija 80 ± 2 mg $\text{NO}_3\text{-N/L}$ pri omjeru C/N 3
 Fig. 3. Denitrification of 80 ± 2 mg $\text{NO}_3\text{-N/L}$ under ratio C/N 3

Zaštita okoliša / Environmental Protection

U denitrifikaciji 35 ± 2 mg $\text{NO}_3\text{-N/L}$ pri omjeru C/N 2 postignuto je 58,5% uklanjanje $\text{NO}_3\text{-N}$ tijekom prvih pola sata pokusa. Odvagana količina natrijeva acetata za omjer C/N 2 je bila nedostatna za potpunu denitrifikaciju. Raspoloživi organski sastojci izraženi kao KPK su utrošeni tijekom 0,5 sata pokusa, pri čemu je tijekom redukcije $\text{NO}_3\text{-N}$ nakupljeno 0,3 mg $\text{NO}_2\text{-N/L}$, koji su se potom denitrificirali. Utroškom raspoloživih organskih sastojaka (KPK), nakon prvih 30 minuta pokusa odvijala se daljnja denitrifikacija $\text{NO}_3\text{-N}$, i do kraja pokusa u 1,25. satu postignuto je 72,5% uklanjanje $\text{NO}_3\text{-N}$, sa unutarstaničnim zalihama ugljika kao donorom elektrona za denitrifikaciju (Slika 1). Dobiveni profil pH je odražavao tijek denitrifikacije, porast pH sa početnih 8,5 na 8,77 u 0,5. satu pokusa, i potom polagano sniženje pH na 8,7 na kraju pokusa u 1,25. satu. Pri omjeru C/N 3 u denitrifikaciji 35 ± 2 mg $\text{NO}_3\text{-N/L}$ (Slike 1 i 2) postignuta je potpuna denitrifikacija. Nakupljeno je 0,7 mg $\text{NO}_2\text{-N/L}$ u 0,5. satu pokusa, koji su se potpuno denitrificirali. Raspoloživi organski sastojci izraženi kao KPK (dodan natrijev acetat za omjer C/N 3) su bili dostatni za potpunu denitrifikaciju (Slika 2). Denitrifikacija 35 ± 2 mg $\text{NO}_3\text{-N/L}$ pri omjeru C/N 3 je postignuta uz brzinu redukcije $\text{NO}_3\text{-N}$ od 64 mg $\text{NO}_3\text{-N/Lh}$, i brzinu oksidacije organskih sastojaka izraženih kao KPK od 373,6 mg KPK/Lh. Specifična brzina denitrifikacije je iznosila 15,6 mg/gh, a specifična brzina uklanjanja organskih sastojaka 91,9 mg KPK/gh. Pri omjeru C/N 3 utrošeno je 5,8 g organskih sastojaka izraženih kao KPK za redukciju 1 g $\text{NO}_3\text{-N}$ (Slike 1 i 2). U profilu pH nastalom temeljem mjerenja pH vrijednosti vidljiva je promjena pH koja je odraz mikrobnih reakcija koje prate tijek denitrifikacije i uočava se rast pH vrijednosti sa 8,67 na maksimalnih 9,12 u 0,5. satu pokusa, i zatim pad pH vrijednosti na 9,11 u 0,75. satu pokusa (Slika 2). Potpuna denitrifikacija 35 ± 2 mg $\text{NO}_3\text{-N/L}$ postignuta je i pri omjeru C/N 4 (Slika 1). Ostvarena je brzina redukcije $\text{NO}_3\text{-N}$ od 64 mg $\text{NO}_3\text{-N/Lh}$ (kao i pri omjeru C/N 3), i brzina uklanjanja organskih sastojaka izraženih kao KPK od 408,8 mg KPK/Lh. Specifična brzina denitrifikacije iznosila je 15,6 mg $\text{NO}_3\text{-N/gh}$, a specifična brzina uklanjanja organskih sastojaka iznosila je 99,7 mg KPK/gh. Maksimalna količina $\text{NO}_2\text{-N}$ od 0,8 mg $\text{NO}_2\text{-N/L}$ je ostvarena u 0,5. satu pokusa, koji su se potpuno denitrificirali u 0,75. satu pokusa. Potrebna količina organskih sastojaka za redukciju $\text{NO}_3\text{-N}$ pri C/N 4 je iznosila 6,4 g KPK po 1 g $\text{NO}_3\text{-N}$ (Slika 1). Mikrobna biomasa u ovom pokusu, pri omjeru C/N 4, ima u suvišku raspoloživog organskog ugljika. Vrijednost pH je rasla sa početnih 8,69 na maksimalnih 9,19 u 0,75. satu pokusa, i zatim se lagano smanjivala.

U pokusima denitrifikacije 80 ± 2 mg $\text{NO}_3\text{-N/L}$ uz natrijev acetat dodan pri omjerima C/N 2, 3 i 4, osigurana je dostatna količina organskih sastojaka izraženih kao KPK za potpunu denitrifikaciju pri omjeru C/N ≥ 3 , kao i u pokusima denitrifikacije 35 ± 2 mg $\text{NO}_3\text{-N/L}$. Denitrifikacija 80 ± 2 mg $\text{NO}_3\text{-N/L}$ pri omjeru C/N 2 je rezultirala 55% uklanjanjem $\text{NO}_3\text{-N}$ tijekom prvih sat vremena pokusa i nakupljeno je 44 mg $\text{NO}_2\text{-N/L}$. Budući da je sav raspoloživi organski sastojak utrošen tijekom prvih sat vremena pokusa, daljnja redukcija $\text{NO}_3\text{-N}$ i $\text{NO}_2\text{-N}$ tijekom naredna 3 sata pokusa se odvijala sa unutarstaničnim zalihama ugljika kao donorima elektrona. Do kraja pokusa u 4. satu postignuto je 83,1% uklanjanje $\text{NO}_3\text{-N}$ a $\text{NO}_2\text{-N}$ su se reducirali od maksimalnih 44 mg $\text{NO}_2\text{-N/L}$ u 1. satu pokusa na 18,5 mg $\text{NO}_2\text{-N/L}$ u 4. satu pokusa (Slika 1). Dok je u procesu bilo raspoloživih organskih sastojaka rasla je pH vrijednost sa početnih 7,84 na maksimalnih 9,34 u 0,75. satu pokusa. Daljnjim vođenjem pokusa pH vrijednost se lagano smanjivala, i na kraju pokusa u 4. satu je iznosila 8,71. Pri omjeru C/N 3 osigurana je dovoljna količina organskih sastojaka izraženih kao KPK za potpunu denitrifikaciju 80 ± 2 mg $\text{NO}_3\text{-N/L}$ (Slike 1 i 3). Brzina redukcije $\text{NO}_3\text{-N}$ je iznosila 44,7 mg $\text{NO}_3\text{-N/Lh}$ a brzina uklanjanja organskih sastojaka izraženih kao KPK je iznosila 312,1 mg

KPK/Lh. Specifična brzina denitrifikacije je iznosila 9,9 mg NO₃-N/gh, a specifična brzina uklanjanja organskih sastojaka je iznosila 69,4 mg KPK/gh (Slike 1 i 3). Tijekom redukcije NO₃-N se prevodio u NO₂-N, a maksimum od 43 mg NO₂-N/L je dosegnut u 0,75. satu pokusa, i do kraja pokusa u 1,75. satu su se potpuno denitrificirali. Za svaki gram NO₃-N bilo je potrebno osigurati 6,9 g KPK. Promjene pH vrijednosti su pratile tijek mikrobnih reakcija, tako je vrijednost pH rasla s početnih 7,66 na maksimalnih 9,37 u 1,5. satu pokusa, i zatim se smanjivala (Slika 3). Potpuna denitrifikacija 80±2 mg NO₃-N/L je postignuta i pri omjeru C/N 4 (Slika 1). Ostvarena je brzina redukcije NO₃-N od 51,9 mg NO₃-N/Lh i brzina uklanjanja organskih sastojaka izraženih kao KPK od 359,7 mg KPK/Lh. Specifična brzina denitrifikacije je iznosila 11,5 mg NO₃-N/gh, a specifična brzina uklanjanja organskih sastojaka je iznosila 79,9 mg KPK/gh. Utrošak organskih sastojaka za redukciju NO₃-N je iznosio 7,9 g KPK po g NO₃-N. U 0,75. satu pokusa postignut je maksimum NO₂-N od 40 mg NO₂-N/L, koji su se do kraja pokusa u 1,75. satu potpuno denitrificirali. Vrijednost pH je rasla od početne 7,89 na 9,74 u 1,75. satu, zatim se smanjivala.

U pokusima denitrifikacije 35±2 mg NO₃-N/L pri C/N 3 i 4, kada je postignuta potpuna denitrifikacija, su određene niske koncentracije NO₂-N (Slika 2). U tim pokusima najveća količina NO₂-N je ostvarena pri omjeru C/N 4 i iznosila je 0,8 mg NO₂-N/L. Niska količina NO₂-N tijekom denitrifikacije upućuje na usklađenost nitrat reduktaze (*Nar*) i nitrit reduktaze (*Nir*) u denitrifikantima, odnosno, sav NO₃-N koji se reducira u NO₂-N se vrlo brzo reducira dalje te su stoga detektirane niske koncentracije NO₂-N tijekom pokusa. S druge strane, u pokusima denitrifikacije 80±2 mg NO₃-N/L zabilježeno je značajno nakupljanje NO₂-N (Slika 3). Maksimalna zabilježena koncentracija NO₂-N u pokusima potpune nitrifikacije je 43 mg NO₂-N/L i 40 mg NO₂-N/L pri omjerima C/N 3 i 4, odnosno NO₂-N su u točki svog maksimuma činili 54% i 50% početne količine NO₃-N. Pan i sur. (2012) ističu da se intermedijeri denitrifikacije akumuliraju zbog kompeticije između četiri dušikove reduktaze za dostupne elektron donore. Kada ima dovoljno elektron donora NO₃-N se puno brže reducira od NO₂-N jer je brzina katalize *Nar* veća od *Nir*. Do akumulacija NO₂-N dolazi prilikom korištenja nekih vrsta izvora ugljika (npr. biodizelski otpad) ili u slučaju kada nema dovoljno dostupnog izvora ugljika, pa do izražaja dolazi kompeticija za dostupne elektrone između *Nar* i *Nir* (Uprety, 2012; Oh i Silverstein, 1999). Almeida i sur. (1995) ističu da je brzina redukcije NO₂-N relativno sporija od brzine redukcije NO₃-N, pa se smatra da je redukcija NO₂-N do NO korak koji ograničava brzinu denitrifikacije, što ima za posljedicu akumulaciju NO₂-N. S druge pak strane, Gerardi (2002) ukazuje da neki denitrifikanti nemaju ključne enzimske sustave za potpunu denitrifikaciju, što je razlog akumulacije intermedijera denitrifikacije, što nije slučaj u ovom istraživanju, jer su se nakupljeni NO₂-N potpuno denitrificirali pri C/N omjerima koji su osigurali dovoljnu količinu organskih sastojaka za potpunu denitrifikaciju. Vrijednost $\Delta\text{KPK}/\Delta\text{NO}_3\text{-N}$ je prikazana za sve omjere C/N iako su pri omjeru C/N 2 raspoloživi organski sastojci bili u deficitu i za denitrifikaciju 35±2 mg NO₃-N/L i 80±2 mg NO₃-N/L kad je ostvarena 58,5% odnosno 55% redukcija NO₃-N.

Omjeri C/N 3 i 4 su osigurali organske sastojke za potpunu denitrifikaciju i 35±2 mg NO₃-N/L i 80±2 mg NO₃-N/L (Slike 1, 2 i 3).

Usporedbom denitrifikacije 35±2 mg NO₃-N/L i 80±2 mg NO₃-N/L pri omjerima C/N 3 i 4 vidljivo je da s porastom omjera C/N raste potreba na KPK za redukciju iste količine NO₃-N (Slika 1). Tako, u denitrifikaciji 35±2 mg NO₃-N/L izračunat omjer $\Delta\text{KPK}/\Delta\text{NO}_3\text{-N}$ je iznosio 5,8 (pri C/N 3) i 6,4 (pri C/N 4), odnosno $\Delta\text{KPK}/\Delta\text{NO}_3\text{-N}$ je iznosio 6,9 (pri C/N 3) i 7,9 (pri C/N 4) u denitrifikaciji

80±2 mg NO₃-N/L. Pri istom odabranom omjeru C/N veća je potreba za KPK u denitrifikaciji 80±2 mg NO₃-N/L u odnosu na 35±2 mg NO₃-N/L. Za istražene početne koncentracije NO₃-N postiže se potpuna denitrifikacija pri C/N≥3, uz acetat kao izvor ugljika, odnosno omjer C/N 3 predstavlja minimalni potrební omjer C/N za potpunu denitrifikaciju. U literaturi (Gerardi, 2002) je istaknuto da mikroorganizmi u anoksičnoj respiraciji utroše oko 25% razgrađenog KPK za proizvodnju mulja ili staničnu sintezu. Budući da je minimalan potreban omjer C/N za potpunu denitrifikaciju 35±2 mg NO₃-N/L kao i za 80±2 mg NO₃-N/L bio 3, veći utrošak organskih sastojaka izraženih kao KPK pri omjeru C/N 4 sugerira da su denitrifikanti razliku utrošenog ugljika pohranili kao unutarstanične rezerve ugljika. Slične spoznaje je dobio Guven (2009) u istraživanju izvora i količine ugljika potrebnog za denitrifikaciju u postrojenjima za obradu otpadnih voda. U tom istraživanju u denitrifikaciji prilikom dodatka lako biorazgradivih organskih spojeva u suvišku, poput acetata, propionata, etanola, glukoze ili metanola, dolazi do relativno visoke potrošnje organskog ugljika i to KPK/NO₃-N 7,1 i KPK/NO₃-N 8,1 zbog mikrobne pohrane energije. Kod denitrifikacije uz organske sastojke dodane u suvišku, potreba za KPK je veća za 80% u odnosu na omjer KPK/NO₃-N 4,5 određen kao potreban za potpunu denitrifikaciju (Guven, 2009).

Brzina uklanjanja organskih sastojaka izraženih kao KPK je u ovom istraživanju rasla s povećanjem omjera C/N. Tako u denitrifikaciji 35±2 mg NO₃-N/L je iznosila 225 mg KPK/Lh (58,5% redukcija NO₃-N sa dodanim izvorom ugljika, pri C/N 2), te 373,6 mg KPK/Lh i 408,8 mg KPK/Lh pri C/N 3 i 4, a u denitrifikaciji 80±2 mg NO₃-N/L brzina uklanjanja organskih sastojaka je iznosila 264,4 mg KPK/Lh (pri C/N 2 kada je ostvarena 55% redukcija NO₃-N), te 312,1 mg KPK/Lh i 359,7 mg KPK/Lh pri C/N 3 i 4. Specifična brzina uklanjanja organskih sastojaka u denitrifikaciji 35±2 mg NO₃-N/L je iznosila 54,9 mg KPK/gh (pri C/N 2 uz 58,5% redukciju NO₃-N sa vanjskim izvorom C), i 91,9 mg KPK/gh i 99,7 mg KPK/gh pri omjerima C/N 3 i 4, a specifična brzina uklanjanja organskih sastojaka u denitrifikaciji 80±2 mg NO₃-N/L je iznosila 58,8 mg KPK/gh (pri C/N 2 i 55% redukcija NO₃-N sa vanjskim izvorom C), i 69,4 mg KPK/gh i 79,9 mg KPK/gh pri C/N 3 i 4. Bergaust i sur. (2011) ističu da brzina denitrifikacije ovisi o raspoloživom topivom organskom ugljiku, koncentraciji NO₂-N i/ili NO₃-N i koncentraciji denitrifikanata u aktivnom mulju.

Brzina redukcije NO₃-N u denitrifikaciji 35±2 mg NO₃-N/L je bila ista pri C/N omjerima koji su osigurali dovoljnu količinu elektron donora, C/N 3 i 4, i iznosila je 64 mg NO₃-N/Lh. Pri omjeru C/N 2, kada nije bilo dovoljno organskih sastojaka za potpunu denitrifikaciju, brzina denitrifikacije 35±2 mg NO₃-N/L je iznosila 40 mg NO₃-N/Lh uz ostvarenu 58,5 % redukciju NO₃-N. U denitrifikaciji 80±2 mg NO₃-N/L, za odabrane omjere C/N, brzina redukcije NO₃-N je rasla s povećanjem omjera C/N, i iznosila je 40,5 mg NO₃-N/Lh (pri C/N 2 i ostignutu 55% redukciju NO₃-N), i 44,7 mg NO₃-N/Lh odnosno 51,9 mg NO₃-N/Lh pri C/N 3 i 4. Denitrifikacija sa limitiranim raspoloživim ugljikom – elektron donorom, pri C/N 2, rezultira nepotpunom redukcijom NO₃-N, te izračunatom brzinom denitrifikacije od 40 mg NO₃-N/Lh i 40,5 mg NO₃-N/Lh u denitrifikaciji 35±2 mg NO₃-N/L i 80±2 mg NO₃-N/L. U pokusima denitrifikacije koji nisu bili limitirani izvorom ugljika brzina denitrifikacije 35±2 mg NO₃-N/L (64 mg NO₃-N/Lh, pri C/N 3 i 4) je bila veća u odnosu na brzinu denitrifikacije 80±2 mg NO₃-N/L (44,7 mg NO₃-N/Lh pri C/N 3 i 51,9 mg NO₃-N/Lh pri C/N 4). Pri odabranim omjerima C/N specifična brzina denitrifikacije 35±2 mg NO₃-N/L je iznosila 9,8 mg NO₃-N/gh (C/N 2, i 58,5% redukcija NO₃-N), odnosno 15,6 mg NO₃-N/gh (C/N 3 i 4), a 80±2 mg NO₃-N/L je iznosila 9,0 mg NO₃-N/gh (C/N 2, i 55% redukcija NO₃-N), te 9,9 mg NO₃-N/gh i 11,5 mg NO₃-N/gh pri C/N 3 i 4. Unatoč malom utjecaju oksidacijskog stanja izvora

ugljika na sintezu denitrificirajućih reduktaza (Stewart i sur., 2009), razina ekspresije ugljikovih oksidaza varira ovisno o vrsti izvora ugljika (Lu i sur., 2011). Zbog toga su kao rezultat neravnoteže između sveukupne količine elektron donora i brzine potrošnje vidljive razlike u kinetici denitrifikacije (Slike 1, 2 i 3).

Tijekom denitrifikacije pH vrijednost raste dok se ne postigne nitratni vrhunac, odnosno potpuna denitrifikacija, zatim se pH lagano smanjuje (Chang i Hao, 1996), što je bila situacija i u ovom istraživanju (Slike 2 i 3).

Aktivni mulj hibridiziran s označnim oligonukleotidnim probama, DEN124 označen bojom cianin 3, na slici vidljivo crveno, a koje su identificirale denitrifikante iz acetat klastera, i EUBmix probama označenim bojom cianin 5, vidljivo zeleno, koje označavaju sve bakterije u aktivnom mulju, je prikazan na slici 4.

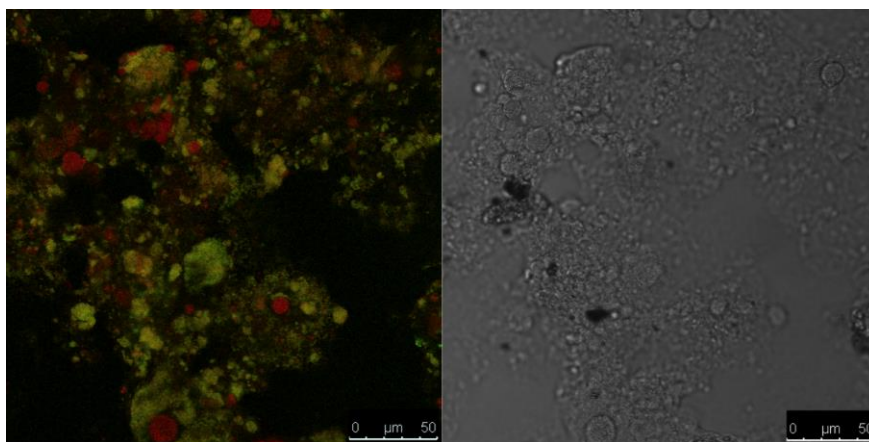

Slika 4. Konfokal laser-skenirajući mikrograf denitrifikanata u aklimatiziranom aktivnom mulju hibridiziranim sa Cy3-označenom probom DEN124 (crveno), a sve bakterije su hibridizirane sa Cy5-označenim EUBmix probama (zeleno)

Fig. 4. Confocal laser-scanning micrograph of denitrificants in acclimatized activated sludge hybridized with Cy3-labeled probe DEN124 (in red), all bacteria are hybridized with Cy5-labeled EUBmix probes (in green)

Zaključci

U denitrifikaciji 35 ± 2 mg $\text{NO}_3\text{-N/L}$ i 80 ± 2 mg $\text{NO}_3\text{-N/L}$ minimalan potreban omjer C/N za potpunu denitrifikaciju je C/N 3. Povećanjem opterećenja sa organskim sastojcima, više od minimalno potrebnog omjera C/N za potpunu denitrifikaciju, veći je utrošak organskih sastojaka izraženih kao KPK za redukciju 1 g $\text{NO}_3\text{-N}$.

Zaštita okoliša / Environmental Protection

Denitrifikacija sa limitiranim raspoloživim ugljikom – elektron donorom, pri C/N 2, rezultira nepotpunom redukcijom NO₃-N, postignuta je 58,5% i 55% redukcija NO₃-N sa dodanim vanjskim izvorom ugljika u denitrifikaciji 35±2 mg NO₃-N/L odnosno 80±2 mg NO₃-N/L.

U pokusima denitrifikacije pri C/N≥3 brzina denitrifikacije 35±2 mg NO₃-N/L je 64 mg NO₃-N/Lh pri C/N 3 i 4, odnosno 44,7 mg NO₃-N/Lh pri C/N 3 i 51,9 mg NO₃-N/Lh pri C/N 4 u denitrifikaciji 80±2 mg NO₃-N/L. Specifična brzina denitrifikacije 35±2 mg NO₃-N/L je 15,6 mg NO₃-N/gh (C/N 3 i 4), a specifična brzina denitrifikacije 80±2 mg NO₃-N/L je iznosila 9,9 mg NO₃-N/gh i 11,5 mg NO₃-N/gh pri C/N 3 i 4. U denitrifikaciji 35±2 mg NO₃-N/L omjer ΔKPK/ΔNO₃-N je iznosio 5,8 (pri C/N 3) i 6,4 (pri C/N 4), odnosno u denitrifikaciji 80±2 mg NO₃-N/L omjer ΔKPK/ΔNO₃-N je iznosio 6,9 (pri C/N 3) i 7,9 (pri C/N 4). Prisustvo denitrifikanata u aktivom mulju je dokazano primjenom FISH analize.

Literatura

- Abufayed, A.A., Schroeder, E.D. (1986): Kinetics and stoichiometry of SBR/denitrification with primary sludge carbon source. *J. Water Pollut. Control Fed.* 58, 398-405.
- Almeida, J.S., Reis, M.A., Carrondo, M.J. (1995): Competition between nitrate and nitrite reduction in denitrification by *Pseudomonas fluorescens*. *Biotechnol. Bioeng.* 46, 476-484.
- Amann, R.I. (1995): Fluorescently labelled, rRNA-targeted oligonucleotide probes in the study of microbial ecology. *Molec Ecol.* 4, 543-554.
- Amann, R.I., Binder, B.J., Olson, R.J., Chisholm, S.W., Devereux, R., Stahl, D.A. (1990): Combination of 16S rRNA-targeted oligonucleotide probes with flow cytometry for analyzing mixed microbial populations. *Appl. Environ. Microbiol.* 56, 1919-1925.
- APHA (1998): Standard Method for the Examination of Water and Wastewater, 2nd Ed., Washington, DC.
- Bergaust, L., Bakken, L.R., Frostegard, A. (2011): Denitrification regulatory phenotype, a new term for the characterization of denitrifying bacteria. *Biochem. Soc. Trans.* 39, 207-212.
- Bernat, K., Wojnowska-Baryla, I. (2007): Carbon source in aerobic denitrification. *Biochem. Eng. J.* 36, 116-122.
- Brian, K., Pratt, S., Gapes, D., Shilton, A. (2007): Investigation into methanol as a carbon source for denitrification in wastewater treatment. U: 49th Annual Conference of the New Zealand Water and Waste Association, Rotorua, New Zealand. 18-21 rujan 2007.
- Chang, C.H., Hao, O.J. (1996): Sequencing batch reactor system for nutrient removal: ORP and pH profiles. *J. Chem. Tech. Biotechnol.* 67, 27-38.
- Constantin, H., Fick, M. (1997): Influence of C-sources on the denitrification rate of a high-nitrate concentrated industrial wastewater. *Water Res.* 31, 583-589.
- Daims, H., Bruhl, A., Amann, R., Schleifer, K.H., Wagner, M. (1999): The domain-specific probe EUB338 is insufficient for the detection of all Bacteria: Development and evaluation of a more comprehensive probe set. *Syst. Appl. Microbiol.* 22, 434-444.
- Elefsiniotis, P., Wareham, D.G. (2007): Utilization patterns of volatile fatty acids in the denitrification reaction. *Enzyme Microb. Technol.* 41, 92-97.

- Fernández-Nava, Y., Marañón, E., Soons, J., Castrillón, L. (2010): Denitrification of high nitrate concentration wastewater using alternative carbon sources. *J. Hazard. Mater.* 173, 682-688.
- Ge, S.J., Peng, Y.Z., Wang, S.Y., Lu, C.C., Cao, X., Zhu, Y.P. (2012): Nitrite accumulation under constant temperature in anoxic denitrification process: the effect of carbon sources and COD/NO₃-N. *Bioresour. Technol.* 114, 137-143.
- Gerardi, M.H. (2002): Nitrification and Denitrification in the Activated Sludge Process, 1st ed. New York: John Wiley & Sons, Inc.
- Ginige, M.P., Keller, J., Blackall, L.L. (2005): Investigation of an Acetate-Fed Denitrifying Microbial Community by Stable Isotope Probing, Full-Cycle rRNA Analysis, and Fluorescent *In Situ* Hybridization-Microautoradiography. *Appl. Environ. Microbiol.* 71, 8683-8691.
- Glass, C., Silverstein, J. (1998): Denitrification kinetics of high-nitrate concentration water: pH effect on inhibition and nitrite accumulation. *Water Res.* 32, 831-839.
- Güven, D. (2009) Effects of Different Carbon Sources on Denitrification Efficiency Associated with Culture Adaptation and C/N Ratio. *Clean.* 37, 565-573.
- Hagman, M., Nielsen, J.L., Nielsen, P.H., Jansen, J.C. (2008): Mixed carbon sources for nitrate reduction in activated sludge-identification of bacteria and process activity studies. *Water Res.* 42, 1539-1546.
- Henze, M. (1991): Capabilities of biological nitrogen removal processes from wastewater. *Water Sci. Technol.* 23, 669-679.
- Her, J.J., Huang, J.S. (1995): Influences of carbon source and C/N ratio on nitrate/ nitrite denitrification and carbon breakthrough. *Bioresour. Technol.* 54, 45-51.
- Lee, N.M., Welander, T. (1996): The effect of different carbon sources on respiratory denitrification in biological wastewater treatment. *J. Ferment. Bioeng.* 82, 277-285.
- Lu, H., Nuruzzaman, F., Ravindhar, J., Chandran, K. (2011): Alcohol dehydrogenase expression as a biomarker of denitrification activity in activated sludge using methanol and glycerol as electron donors. *Environ. Microbiol.* 13, 2930-2938.
- Oh, J., Silverstein, J. (1999): Acetate limitation and nitrite accumulation during denitrification. *J. Environ. Eng.* 125, 234-242.
- Pan, Y., Ye, L., Ni, B.J., Yuan, Z. (2012): Effect of pH on N₂O reduction and accumulation during denitrification by methanol utilizing denitrifiers. *Water Res.* 46, 4832-4840.
- Pravilnik o graničnim vrijednostima emisija otpadnih voda (NN 080/2013).
- Pravilnik o izmjenama i dopunama pravilnika o graničnim vrijednostima emisija otpadnih voda (NN 03/2016).
- Rabalais, N.N. (2002): Nitrogen in aquatic ecosystems. *Ambio.* 31, 102-112.
- Shapleigh, J.P. (2006): The denitrifying prokaryotes. U: Dworkin, M., Falkow, S., Rosenberg, E., Schleifer, K.-H., Stackebrandt, E. (ur.), *The Prokaryotes*. Springer, New York.
- Srinandan, C.S., D'souza, G., Srivastava, N., Nayak, B.B., Nerurkr, A.S. (2012): Carbon sources influence the nitrate removal activity, community structure and biofilm architecture. *Bioresour. Technol.* 117, 292-299.

- Stewart, V., Bledsoe, P.J., Chen, L.L., Cai, A. (2009): Catabolite repression control of 960 napF (periplasmic nitrate reductase) operon expression in *Escherichia coli* K-12. *J. Bacteriol.* 191, 996-1005.
- Tam, N.F.Y., Wong, Y.S., Leung, G. (1992): Significance of external carbon source on simultaneous removal of nutrients from wastewater. *Water Sci. Technol.* 26, 1047-1055.
- Uprety, K. (2012) Evaluation of Glycerol and Waste Alcohol as Supplemental Carbon Sources for Denitrification (MS thesis), Virginia Polytechnic Institute and State University.
- Vitousek, P.M., Howarth, R.W. (1991): Nitrogen limitation on land and in the sea: how can it occur? *Biochemistry.* 13, 87-115.
- Xu, Y., Qiu, T.L., Han, M.L., Li, J., Wang, X.M. (2011): Heterotrophic denitrification of nitrate-contaminated water using different solid carbon sources. *Procedia Environ. Sci.* 10, 72-77.

Original research paper

Denitrification: The effect of C/N ratio

Dijana Grgas¹, Tea Širac¹, Morena Prodan¹, Andrijana Brozinčević²,
Tibela Landeka Dragičević^{1*}

¹University of Zagreb, Faculty of Food Technology and Biotechnology,
Pierotti Str. 6, 10000 Zagreb, Croatia

²Plitvice Lakes National Park, Josipa Jovića 19, 53231 Plitvička jezera, Croatia

*Corresponding author: tandekadragicevic@pbf.hr

Summary

The denitrification of 35±2 mg NO₃-N/L and 80±2 mg NO₃-N/L with sodium acetate as a carbon source at C/N ratio of 2, 3, and 4, was investigated. The minimum ratio of C/N 3 was needed for total denitrification. The specific denitrification rate was determined, as well as the amount of COD required for NO₃-N reduction (mg COD/mg NO₃-N). The ratio of ΔCOD/ΔNO₃-N of 5,8 (at C/N 3), and 6,4 (at C/N 4) was determined for denitrification of 35±2 mg NO₃-N/L, and for denitrification of 80±2 mg NO₃-N/L the ratio of ΔCOD/ΔNO₃-N was 6,9 (at C/N 3), and 7,9 (at C/N 4).

The denitrification rate of 64 mg NO₃-N/Lh was determined in denitrification 35±2 mg NO₃-N/L at C/N ratios 3 and 4, and also the denitrification rate of 44,7 mg NO₃-N/Lh, and 51,9 mg NO₃-N/Lh was achieved in denitrification 80±2 mg NO₃-N/L at C/N ratios 3 and 4. Denitrification of 35±2 mg NO₃-N/L, and 80±2 mg NO₃-N/L with a limited C source – electron donor, at C/N 2, resulted with a 58,5%, and a 55% reduction of NO₃-N (with the external C source added). The denitrification of NO₃-N was conducted with activated sludge adapted for the denitrification process. The presence of DNI species in the activated sludge was proved by using the FISH (fluorescence *in situ* hybridization) method.

Keywords: denitrification, acetate, C/N ratio

Stručni rad

Održivi razvoj gospodarenja otpadom kroz mjere upravljačkog nadzora

Luči Veljačić^{1*}, Anamarija Veljačić¹, Ante Mrčela²

¹A.D.V. GRUPA d.o.o., Cesta dr. F. Tuđmana 861, 21 217 Kaštel Štafilić, Hrvatska

²Ivana Gundulića 22, 21 000 Split, Hrvatska

*Dopisni autor: luci.veljacic@gmail.com

Sažetak

Sustav gospodarenja otpadom u RH uređen je na načelima, ciljevima i načinima gospodarenja otpadom bez uporabe rizičnih postupaka po ljudsko zdravlje i okoliš te uz korištenje vrijednih svojstava otpada. Održivim gospodarenjem otpadom moraju se poštivati mjere za sprječavanje ili smanjenje štetnog djelovanja otpada na ljudsko zdravlje i okoliš smanjenjem količina otpada na mjestu nastanka i/ili u proizvodnji. Ovisno o postupku i procesu gospodarenje otpadom za koje je ishoda dozvola od nadležnog tijela, mjerama upravljačkog nadzora provodi se gospodarenje otpadom na određenoj lokaciji, a upravljački nadzor gospodarenja otpadom provodi osoba odgovorna za gospodarenje otpadom. Sustav upravljačkog nadzora sastoji se od kontrole tehničko-tehnoloških uvjeta obavljanja procesa gospodarenja otpadom te sigurnosno-preventivnih mjera u slučaju izvanrednih događaja. Nadzorom tehnološkog procesa osigurava se provođenje metoda kao funkcionalno tehnoloških cjelina materijalnog toka otpada na lokaciji, ispunjavanje mjera upravljačkog nadzora, sukladno načinu gospodarenja otpadom propisanih Direktivama EU, Zakonima i Pravilnicima.

Ključne riječi: mjere upravljačkog nadzora, održivo gospodarenje otpadom, odgovorna osoba

Uvod

Problem nastanka otpada postao je izražen u drugoj polovini 20. stoljeća uslijed naglog porasta broja stanovnika na Zemlji koji su većinom koncentrirani u velikim gradovima te pospiješeno brzim razvojem tehnologija i nekontroliranim iskorištavanjem prirodnih resursa. Povećanje proizvodnje u svim sferama ljudskog života, praćeno izraženim potrošačkim mentalitetom, dovelo je do stvaranja velikih količina otpada koje su počele direktno ugrožavati okoliš, a samim time i zdravlje ljudi u takvim sredinama. Da bi se riješio problem nastalog otpada započelo se u svijetu sa donošenjem raznih zakonodavnih okvira kako bi se uveli nadzori nad otpadom, tehnologijama obrade otpada, smanjili doticaji otpada sa okolišem te smanjili štetni utjecaji otpada na okoliš i zdravlje ljudi. Kako bi se sačuvalo prirodne resurse za buduće generacije, s vremenom se uvidjelo da je osim zakonodavstva potrebno uvesti cjelovite sustave održivog razvoja gospodarenja otpadom radi smanjenja nastajanja otpada na minimum, a otpad početi koristiti kao novu sirovinu. Proces takvih promjena podrazumijevao je usuglašene uporabe resursa, investiranja, tehnički razvoj i institucionalne promjene.

Zaštita okoliša / Environmental Protection

Promjene u gospodarenju otpadom morale su započeti od svakog pojedinca, promjenama osobnih vrijednosti do promjena na svim područjima života sa ciljem poboljšanja kvalitete života uključujući društvene, ekonomske i ekološke čimbenike. Međutim to bi bilo nemoguće ukoliko se ne vodi računa o okolišu i njegovom kapacitetu na način da postane potpora ljudskom djelovanju te ukoliko se ne postigne ravnoteža važnosti individualnih prava s kolektivnom odgovornošću.

Održivi razvoj ima za cilj povezivanje gospodarstva, društva i okoliša na cjelovit način kako bi se postiglo trajno rješenje, vodeći računa o potrebama budućih generacija kao i današnjih. Ujedno traži izbjegavanje problema u budućnosti time što se na njihovom rješenju radi u sadašnjosti. Stoga je potrebno planirati suradnju između eksperata i običnih ljudi kako bi planovi i prijedlozi zadovoljili potrebe svih. Održivi razvoj u tom smislu ima tri dimenzije (slika 1.):

1. gospodarska koja uključuje rast zapošljavanja, povećanje plaće, veće investicije, trgovinu, poduzetništvo, inovacije i sl.
2. društvena predstavlja socijalnu dimenziju koja uključuje zdravlje, riješeno stambeno pitanje, školovanje, prevenciju kriminala, demokraciju, slobodno vrijeme i dr. jer razvoj ne može biti održiv ako nije pravedan ili ako ne zadovoljava goruće potrebe stanovništva na Zemlji.
3. okolišna koja uključuje zrak, vodu i kvalitetu tla, zaštitu staništa, djelotvorno korištenje i ponovnu uporabu prirodnih resursa i energije, tj. podrazumijeva stjecanje takvog znanja koje će omogućiti da se cijene, održavaju i razvijaju u prednosti okoliša.



Slika1. Dimenzije održivog razvoja (Pavić i sur., 2015.)

Fig.1. Dimensions of sustainable development (Pavic and et al., 2015.)

Gospodarenje otpadom kao dio održivog razvoja mora se osigurati na način da otpad koji preostaje nakon postupka obrade i koji se zbrinjava odlaganjem ne predstavlja opasnost za buduće generacije. Gospodarenje otpadom mora se provoditi na način koji ne dovodi u opasnost ljudsko zdravlje i koji ne dovodi do štetnih utjecaja na okoliš, a osobito kako bi se izbjegao rizik od onečišćenja mora, voda, tla i zraka, kako bi se izbjegla pojava neugode uzrokovana bukom i/ili mirisom, da bi se spriječio štetan utjecaj na područja kulturno–povijesnih, estetskih i prirodnih vrijednosti te nastajanje eksplozije ili požara.

Gospodarenje otpadom predstavlja racionalno gospodarenje vrijednim sirovinama i resursima koji su vlasništvo svih ljudi, a izrazito je bitno u ekološkom i ekonomskom smislu.

Materijali i metode

Ustav Republike Hrvatske jamči osobitu zaštitu mora, morske obale i otoka, vode, zračnog prostora, rudnog blaga i drugih prirodnih bogatstava, zemljišta, šuma, biljnog i životinjskog svijeta, drugih dijelova prirode, nekretnina i stvari od osobito kulturnog, povijesnog, gospodarskog i ekološkog značenja, kao dobra od interesa za RH. Pravo na zdrav život također je jedna od ustavnih odredbi. Država je obvezna osigurati uvjete za zdrav život, a svatko je dužan, u sklopu svojih ovlasti i djelatnosti, osobitu skrb posvećivati zaštiti zdravlja ljudi, prirode i okoliša.

Ustavnopravno uređenje okoliša i njegove zaštite važno je stoga što zakonske i druge norme moraju biti posve usklađene s ustavom, odnosno s njegovim izvorišnim osnovama tako da doneseni zakoni, podzakonski akti te norme i sl. moraju slijediti društvene uzroke koje je ustav obilježio kao izvor ali i granice preko kojih se ne smije ići. Svrha je tih ustavnopravnih normi postizanje triju važnih ciljeva ekološke politike izraženih u načelima kakvoće življenja, dužnosti prema budućim generacijama i održivog razvoja. Deklaracija o zaštiti okoliša u Republici Hrvatskoj (N.N. br. 34/92) koja je donesena na temelju Ustava, definira RH kao zemlju izrazito bogatu raznolikim prirodnim vrijednostima koja se opredjeljuje za gospodarski održiv razvitak utemeljen na poljoprivredi, šumarstvu, pomorstvu i turizmu, gospodarstvu i industriji zasnovanoj na ekološki dopustivim tehnologijama. Kako bi nedovoljno osmišljena obnova i gospodarski razvoj mogli povećati uništavanje okoliša, upravljanje otpadom se mora sa mjera orijentiranih na posljedice, usmjeriti na mjere orijentirane na uzroke prema hijerarhijskim ciljevima: sprječavanje nastajanja otpada, reciklaža i ponovno korištenje kao sekundarne sirovine, sigurno odlaganje ostatka koji se ne može upotrijebiti, zabrana voza opasnog otpada te smanjenje i kontrola transporta opasnog otpada kao i sanacija dosadašnjeg nekontroliranog odlaganja. Deklaracija je usmjerena na moto „*misli globalno, djeluj lokalno*“, koja će se provesti u nadležnom ministarstvu putem zakonske regulative te objedinjavanja prostorno-planskih dokumenata.

Rezultati i rasprava

Zakon o održivom gospodarenju otpadom (N.N. br. 94/13) jedan je od krovnih zakona na području zaštite okoliša, te djeluje u smjeru potpune promjene navike građana i slike Republike Hrvatske. Preduvjet za uspostavu takve slike funkcioniranja cjelovitog sustava gospodarenja sirovinama i energijom je prije svega odvojeno sakupljanje otpada na mjestu nastanka. Ovim su Zakonom u pravni poredak Republike Hrvatske prenesene određene direktive Europske unije te je utvrđen okvir za provedbu specifičnih uredbi EU. Također, Zakonom su utvrđene mjere za sprječavanje ili smanjenje štetnog djelovanja otpada na ljudsko zdravlje i okoliš na način smanjenja količina otpada u nastanku i/ili proizvodnji te se uređuje gospodarenje otpadom bez uporabe rizičnih postupaka po ljudsko zdravlje i okoliš, uz korištenje vrijednih svojstava otpada. U Republici Hrvatskoj otpad se sukladno Zakonu o održivom gospodarenju otpadom (N.N. br. 94/13) definira kao svaka tvar ili predmet koje posjednik odbacuje, namjerava ili mora odbaciti. Otpadom se smatra i svaki predmet i tvar čije su sakupljanje, prijevoz i obrada nužni u svrhu zaštite javnog interesa.

Zaštita okoliša / Environmental Protection

Ovisno o svojstvima, otpad se može podijeliti na opasni, neopasni i inertni otpad, dok se po mjestu nastanka razlikuje više vrsta otpada kao što su komunalni otpad, proizvodni (otpad iz rudarstva i eksploatacije mineralnih sirovina, građevinski otpad, mulj iz uređaja za pročišćavanje otpadnih voda i sl.) te posebne kategorije otpada (ambalažni, otpadni električki i električni uređaji i oprema, vozila kojima je istekao vijek trajanja, otpadne gume, otpadna ulja i sl.). Odredbe ovoga Zakona utvrđuju sustav gospodarenja otpadom u Republici Hrvatskoj uključujući red prvenstva gospodarenja otpadom, načela, ciljeve i način gospodarenja otpadom, strateške i programske dokumente u gospodarenju otpadom, nadležnosti i obveze u gospodarenju otpadom, lokacije i građevine za gospodarenje otpadom, djelatnosti gospodarenja otpadom, prekogranični promet otpada, informacijski sustav gospodarenja otpadom te upravni i inspekcijski nadzor nad gospodarenjem otpadom. Gospodarenje otpadom temelji se na uvažavanju načela zaštite okoliša propisanih zakonom kojim se uređuje zaštita okoliša i pravnom stečevinom Europske unije, načelima međunarodnog prava zaštite okoliša te znanstvenih spoznaja, najbolje svjetske prakse i pravila struke, a osobito na "*načelu onečišćivača*", "*načelu blizine*", "*načelu samodostatnosti*", "*načelu sljedivosti*". Proizvođač proizvoda od kojeg nastaje otpad, odnosno proizvođač otpada snosi troškove gospodarenja tim otpadom. U svrhu sprječavanja nastanka otpada te primjene propisa i politike gospodarenja otpadom primjenjuje se red prvenstva gospodarenja otpadom (slika 2.), koji započinje sa sprečavanjem nastanka otpada, potom slijedi priprema za ponovnu uporabu, zatim recikliranje pa drugi postupci uporabe, dok je postupak zbrinjavanja otpada, koji uključuje i odlaganje otpada, najmanje poželjan postupak gospodarenja otpadom.

Gospodarenje otpadom je složena djelatnost koja zahvaća sve grane gospodarstva, proizvodnje i potrošnje, a sadrži čitav niz postupaka i tehnologija od kojih se velik dio primjenjuje u različitim oblicima. Zakonom o održivom gospodarenju otpadom, gospodarenje otpadom je definirano kao djelatnosti sakupljanja, prijevoza, uporabe i zbrinjavanja i druge obrade otpada, uključujući nadzor nad tim postupcima te nadzor i mjere koje se provode na lokacijama nakon zbrinjavanja otpada kao i radnje koje poduzimaju trgovac otpadom ili posrednik. Također, ovim zakonom su definirani i postupci gospodarenja otpadom, a to su: sakupljanje otpada, interventno sakupljanje otpada, priprema za ponovnu uporabu, priprema prije uporabe i zbrinjavanja, postupci uporabe i zbrinjavanja, trgovanje otpadom, posredovanje u gospodarenju otpadom, prijevoz otpada, energetska uporaba određenog otpada, sakupljanje otpada u reciklažno dvorište i privremeno skladištenje vlastitog proizvodnog otpada. Nadalje, ovim zakonom je određeno da pravna i fizička osoba-obrtnik može, nakon što ishodi upis u odgovarajuće očevidnike za gospodarenje otpadom i/ili odgovarajuću dozvolu, započeti obavljati djelatnost sakupljanja otpada postupkom sakupljanja otpada i interventnog sakupljanja otpada te djelatnost uporabe, zbrinjavanja ili druge obrade otpada. Zakonom o održivom gospodarenju otpadom propisana je obveza proizvođača otpada i drugog posjednika otpada prema kojoj je dužan predati svoj otpad osobi koja obavlja djelatnost gospodarenja otpadom radi daljnjeg zakonitog postupanja s otpadom (obrada otpada, odlaganje i sl.).

Pravilnikom o gospodarenju otpadom (N.N. br. 23/14, 51/14, 121/15 i 132/15) definirani su uvjeti za gospodarenje otpadom s pripadajućim tehnološkim procesima koji je uključen u djelatnost za koju se izdaje dozvola za gospodarenje otpadom te uvjeti za obavljanje djelatnosti trgovanja otpadom.



Slika 2. Shematski prikaz reda prvenstava u gospodarenju otpadom (Medven i sur., 2009.)
Fig. 2. Scheme representation order of priority in waste management (Medven and et al., 2009.)

Mjere upravljačkog nadzora gospodarenja otpadom na temelju zakonskih propisa o zaštiti okoliša i gospodarenju otpadom provodi osoba odgovorna za gospodarenje otpadom koja je dužna osigurati gospodarenje otpadom sukladno dozvoli za gospodarenje otpadom ili očevidnicima, osigurati praćenje i provedbu plana postupanja u slučaju izvanrednih događaja, provoditi kontrolu mjera radi onemogućavanja pristupa neovlaštenim osobama, provoditi kontrolu mjera čišćenja i uklanjanja rasutog i/ili razlivenog otpada, voditi evidenciju o izvanrednim događajima u građevini za gospodarenje otpadom, organizirati i nadgledati provedbu sustava upravljačkog nadzora sukladno dozvoli za gospodarenje otpadom i sl.

Pisane upute rada za obavljanje tehnološkog procesa sadrži način obveznog postupanja radnika pri obavljanju tehnološkog procesa (hodogram aktivnosti). Sigurnosno-preventivne mjere u gospodarenju otpadom provode se ovisno o tehnološkom procesu rada uz primjenu mjera zaštite na radu, zaštite od požara, zaštite okoliša te sigurnosno/preventivnih mjera.

Zaključci

Neodgovarajuće gospodarenje otpadom je jedan od najvećih problema zaštite okoliša te otpad treba staviti pod kontrolu i svesti na minimum, tako da se očuvaju postojeći resursi za buduće generacije. Posljedice neodgovarajućeg gospodarenja otpadom mogu se negativno odraziti na sastavnice okoliša kao što su voda, zrak, more i tlo te na klimu, ljudsko zdravlje i drugi živi svijet. Stoga je potrebno učinkovito i brzo riješavati probleme temeljem cjelovitog sustava održivog gospodarenja otpadom i putem definiranih mjera upravljačkog nadzora.

Nadzorom tehnološkog procesa osigurava se provođenje metoda kao funkcionalno tehnoloških cjelina materijalnog toka otpada na lokaciji, ispunjavanje mjera upravljačkog nadzora, sukladno načinu gospodarenja otpadom propisanih Direktivama EU, Zakonima i provedbenim dokumentima.

Literatura

- Pavić, R.L., Jelić, M.V., Jagnjić, M. (2015): Odras-Održivi razvoj zajednice: Globalni ciljevi održivog razvoja do 2030., Zagreb, RH, p.p. 1.
- Medven, Ž., Veidemane, K. (2009): Regionalni centar zaštite okoliša za Srednju i Istočnu Europu: EU i zaštita okoliša-gospodarenjeotpadom na lokalnoj razini, Zagreb, RH: Tisak Znanje d.d., p.p. 12.

Professional paper

Sustainable development waste management through control measures

Luči Veljačić^{1*}, Anamarija Veljačić¹, Ante Mrčela²

¹A.D.V. GRUPA d.o.o., Cesta dr.F.Tuđmana 861, 21 217 Kaštel Štafilić, Croatia

²Ivana Gundulića 22, 21 000 Split, Croatia

*Corresponding author: luci.veljacic@gmail.com

Summary

The waste management system in Croatia is arranged by the principles, objectives and ways of waste management without the use of high-risk procedures to human health and the environment, and the use of valuable properties of waste.

Sustainable waste management must respect measures for preventing or reducing the harmful effects of waste on human health and the environment in a way to reduce the amount of waste in the development and/or production.

Depending on the procedure and the process of waste management for which was obtained the permission of the competent authority, implemented management control measures performing waste management at a specific location, and management oversight of waste management carried out by a person responsible for waste management.

The controller system consists of technical and technological conditions control of performing the process of waste management and safety preventive measures in case of accidents.

Control of technological process ensures the method implementation as functional technological units of material flow of waste on site, meeting the control measures of control, according to the method of waste management as prescribed by the law, EU Directives and Regulations.

Keywords: control measures of control, sustainable waste management, responsible person

Izvorni znanstveni rad

Obezbojenje sintetskih bojila na agarnim pločama odabranim gljivama

Natalija Velić^{1*}, Hrvoje Pavlović¹, Mirjana Pavičić¹, Antonija Kezerle²

¹ Sveučilište J. J. Strossmayera u Osijeku, Prehrambeno-tehnološki fakultet Osijek,
F. Kuhača 20, 31 000 Osijek

² Vodovod-Osijek d.o.o., Poljski put 1, 31 000 Osijek, Hrvatska

*Dopisni autor: natalija.velic@ptfos.hr

Sažetak

U ovom radu istražena je sposobnost obezbojenja sintetskih bojila (malahitno zelenilo MZ, kristal violet KV, fuksin F i metilensko modrililo MM) pomoću četiri vrste gljiva bijelog truljenja: *P. chrysosporium* CCBAS 570, *T. versicolor* CCBAS AG613, *T. versicolor* TV6 i *C. subvermispora*. Gljive su uzgajane pri 27 °C 9 (10) dana na agarnim pločama s dodatkom bojila u koncentracijama 50, 100 i 150 mg L⁻¹. Zona rasta kolonija te zona obezbojenja (promjene boje) mjerene su (u dva međusobno okomita smjera) svaka 3 dana. MZ je snažno inhibiralo rast svih vrsta, ali su sve pokazale dobru sposobnost obezbojenja ovog bojila, što je vidljivo iz velikog indeksa obezbojenja (promjer obezbojenja/promjer kolonije) u rasponu od 2,42 do 6,04. Sposobnost djelomičnog obezbojenja KV pokazale su sve vrste gljiva, pri čemu je rast vrsta *P. chrysosporium* i *C. subvermispora* bio snažno inhibiran ovim bojilom. F je inhibirao rast odabranih gljiva samo tijekom prvih dana uzgoja. Sposobnost obezbojenja F pokazale su sve vrste, ali indeks obezbojenja nije bio velik (0,24 – 1). Inhibicija rasta ovim bojilom primijećena je samo u prvim danima uzgoja. MM nije inhibiralo rast gljiva, ali je djelomičnu sposobnost obezbojenja ovog bojila pokazala jedino vrsta *T. versicolor* TV6. Utvrđeno je kako primijenjene koncentracije bojila u podlozi statistički značajno utječu na rast kolonija gljiva, ali nije utvrđena statistički značajna razlika u sposobnosti obezbojenja.

Ključne riječi: sintetska bojila, *P. chrysosporium*, *T. versicolor*, *C. subvermispora*, obezbojenje

Uvod

Sintetska bojila ubrajaju se u skupinu vrlo opasnih onečišćujućih tvari, koje putem industrijskih otpadnih voda dospijevaju u okoliš. Većinom su organske prirode i aromatske strukture (benzenski i/ili naftalenski tip) (Gudelj i sur., 2011) te ulaze u skupinu ksenobiotičkih spojeva (Yu i Wen, 2005). Između ostalih svojstava, bojila moraju biti postojana i otporna na kemijsko i mikrobiološko djelovanje te na djelovanje svjetlosti, što za posljedicu ima njihovo dugo zadržavanje u okolišu, odnosno tešku razgradnju (Adedayo i sur., 2004). Njihovo uklanjanje iz okoliša zahtijeva primjenu složenih i dugotrajnih procesa. Bojila smanjuju prodiranje svjetlosti u vodu, što rezultira smanjenom koncentracijom kisika u vodotocima. Nadalje, ona djeluju toksično i genotoksično na vodene ekosustave te, također, pokazuju mutageni i kancerogeni učinak na ljude (Saratale i sur., 2011). Zbog svega navedenog, važno je ukloniti bojila iz obojenih otpadnih voda prije njihova ispuštanja u okoliš. Najčešće se za uklanjanje bojila iz otpadnih voda koriste fizikalno-kemijske metode poput adsorpcije, koagulacije, filtracije, kemijske razgradnje, primjene naprednih oksidacijskih procesa, itd. Primjena ovih metoda često je financijski, metodološki i vremenski vrlo zahtjevna, pri čemu se

Zaštita okoliša / Environmental Protection

nužno ne postiže visoka učinkovitost (Asgher i Bhatti, 2007; Sandhya i sur., 2005). Biološke metode predstavljaju alternativu fizikalno-kemijskim metodama i uključuju procese biosorpcije (adsorpcija bojila na živu ili inaktivnu biomasu mikroorganizama), biorazgradnje i biotransformacije te bioakumulacije. Osnovne prednosti primjene bioloških metoda su niska cijena, visoka učinkovitost, često potpuna biorazgradnja bojila ili nastajanje produkata manje toksičnosti od polaznog spoja. Osnovni nedostaci, u usporedbi s fizikalno-kemijskim metodama, su manja mogućnost kontrole i dugotrajnost bioprocasa, što je, još uvijek, prepreka široj primjeni ovih metoda na realnim sustavima (Gupta i Suhas, 2009). Mikroorganizmi koji se istražuju u ovu svrhu uključuju aerobne i anaerobne vrste bakterija, neke alge i velik broj različitih vrsta gljiva, koje su se pokazale najučinkovitijima za primjenu u bioremedijaciji obojenih otpadnih voda (Gupta i Suhas, 2009). Gljive bijelog truljenja skupina su mikroorganizama koja se najintenzivnije proučavaju u tu svrhu, ali i u druge svrhe poput razgradnje ksenobiotika, razgradnje lignoceluloznih materijala s ciljem proizvodnje biogoriva, proizvodnje enzima, itd. (Eichlerová i sur., 2006; Forgacs i sur., 2004; Wesenberg i sur., 2003). Enzimski sustavi ovih gljiva, koji uključuju izvanstanične enzime odgovorne za razgradnju lignina, omogućuju im razgradnju različitih ksenobiotika poput policikličkih aromatskih ugljikovodika, polikloriranih bifenila, pesticida i sintetskih bojila (Elisashavili i sur., 2009). Najvažniji enzimi u procesu biorazgradnje bojila koje sintetiziraju ove vrste su enzimi uključeni u razgradnju lignina: lakaza, lignin peroksidaza i mangan peroksidaza (Santos i Corso, 2014; Eshghia i sur., 2011; Jayasinghe i sur., 2008). U ovom radu istražena je sposobnost obezbojenja sintetskih bojila malahitnog zelenila, kristal violeta, fuksina te metilenskog modrila pomoću četiri vrste gljiva bijelog truljenja *Phanerochaete chrysosporium* CCBAS 570, *Trametes versicolor* CCBAS AG613, *Trametes versicolor* TV6 i *Ceriporiopsis subvermispora* na agarnim pločama s dodatkom bojila u različitim koncentracijama, što je metoda koja se koristi za probir vrsta koje posjeduju potencijal za daljnju biotehnošku primjenu.

Materijali i metode

Bojila

U radu su korištena bojila malahitno zelenilo, fuksin, kristal violet i metilensko modrilo (sve Kemika d.d., Zagreb, Hrvatska) (slika 1.).

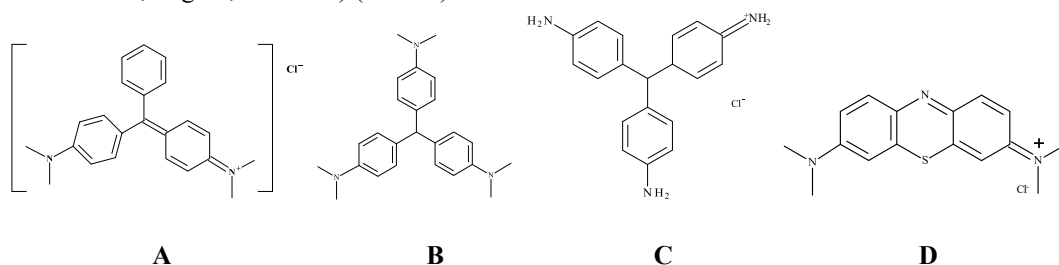

Slika 1. Strukturne formule odabranih bojila: A) malahitno zelenilo, B) kristal violet, C) fuksin, D) metilensko modrilo

Fig. 1. Structural formulas of selected dyes: A) malchite green, B) crystal violet, C) fuchsin, D) methylene blue

Mikroorganizmi

Istraživane su četiri vrste gljiva bijelog truljenja: *P. chrysosporium* 570 i *T. versicolor* AG 613 (Culture Collection of Basidiomycetes, Prag, Češka) te *T. versicolor* TV-6 i *C. subvermispora* (MZKI, Culture Collection of the National Institute of Chemistry Ljubljana, Slovenija). Gljive su održavane u Petrijevim zdjelicama na krumpirovom agaru i čuvane pri 4 °C u hladnjaku. Kao inokulum, u daljnjim pokusima obezbojenja bojila, korišteni su micelijski diskovi (promjera 6 mm) kulture stare 7 dana i uzgajane na 27 °C.

Istraživanje sposobnosti obezbojenja agarnih ploča

Osnovne otopine istraživanih bojila pripravljene su odvagom 0,1 g bojila i dodatkom 3 mL sterilne demineralizirane vode u sterilnu epruvetu. Iz osnovnih su otopina preneseni odgovarajući volumeni otopljenih bojila u tikvice sa sterilnim krumpirovim agarom (Liofilchem, Italija) radi postizanja konačnih koncentracija bojila u hranjivim podlogama od 50 mg L⁻¹, 100 mg L⁻¹ i 150 mg L⁻¹. Podloge su razlivene u Petrijeve zdjelice promjera 90 mm i nacijepljene micelijskim diskovima promjera 6 mm kultura starih 7 dana. Kao abiotička kontrola korištene su nenacijepljene obojene hranjive podloge, dok je kao biotička kontrola korištena hranjiva podloga bez dodatka bojila i nacijepljena na isti način kao obojene podloge. Sve Petrijeve zdjelice inkubirane su pri 27 °C kroz 9 (10) dana. Rast kolonije i promjer zone obezbojenja su mjereni u 2 međusobno okomita smjera, svaka tri dana. Dobiveni rezultati su izraženi kao indeks obezbojenja (promjer zone obezbojenja/promjer micelija) i statistički obrađeni programima GraphPad Prism ver. 6 i Microsoft Excel 2013.

Rezultati i rasprava

Sposobnost obezbojenja bojila na agarnim pločama s odabranim bojilima izražena kao indeks obezbojenja prikazana je u tablici 1. Indeks obezbojenja izražen je kao omjer promjera obezbojenja (mm) i promjera kolonije (mm) izmjerenog 9., odnosno 10. dana uzgoja. Veći indeks obezbojenja ukazuje na bolju sposobnost gljive za razgradnju bojila (Jayasinghe i sur., 2008), ali pri razmatranju indeksa obezbojenja valja voditi računa i o brzini rasta mikroorganizma (inhibiciji rasta zbog dodatka bojila). Veliki indeks obezbojenja, uz istovremenu snažnu inhibiciju rasta, rezultat će obezbojenjem tek dijela ukupne površine obojene agarne ploče. Do potpunog obezbojenja cijele površine agarnih ploča za većinu bojila došlo je tek nakon 20 do 30 dana uzgoja, dok pri najvećoj koncentraciji bojila do potpunog obezbojenja nije došlo.

Indeks obezbojenja određen nakon 9, odnosno 10 dana uzgoja omogućuje probir onih vrsta koje će brže i učinkovitije provesti razgradnju bojila. Iz rezultata prikazanih u tablici 1. vidljivo je da su svi mikroorganizmi tijekom 9 odnosno 10 dana uzgoja, do određene mjere obezbojili bojila iz skupine trifenilmetanskih bojila – malahitno zelenilo, fuksin i kristal violet. Pri tome je obezbojenje malahitnog zelenila najučinkovitije, što se vidi iz izrazito velikog indeksa obezbojenja. Malahitno zelenilo ujedno je i bojilo koje je najjače inhibiralo rast svih gljiva. Eichlerová i sur. (2006a, 2006) istraživali su sposobnost obezbojenja agrarnih ploča s dodatkom malahitnog zelenila pomoću gljiva bijelog truljenja *Dichomitus squalens*, *P. chrysosporium*, *Pleurotus ostreatus* i *T. versicolor*. Koncentracije malahitnog zelenila u podlozi iznosile su od 50 do 1000 mg L⁻¹, što je dovelo do potpune inhibicije rasta.

Zaštita okoliša / Environmental Protection

Tablica 1. Obezbojenje različitih bojila pomoću gljiva bijelog truljenja
 Table 1. Decolourisation of different dyes using white rot fungi

Mikroorganizam	$\gamma_{bojilo}/\text{mg L}^{-1}$	Malahitno zelenilo	Fuksin	Kristal violet	Metilensko modrilo
		Indeks obezbojenja			
<i>P. chrysosporium</i> CCBAS 570	50	4,40	1,00	4,44	0,00
	100	4,44	0,42	4,46	0,00
	150	4,30	0,00	4,45	0,00
<i>T. versicolor</i> CCBAS AG613	50	2,42	0,69	1,55	0,00
	100	2,94	0,49	1,57	0,00
	150	3,44	0,58	1,52	0,00
<i>T. versicolor</i> TV6	50	3,01	0,73	1,04	0,52
	100	6,01	0,65	1,02	0,27
	150	5,43	0,60	1,19	0,37
<i>C. subvermispora</i>	50	5,31	0,24**	2,92	0,00
	100	6,04	na***	3,03	0,00
	150	5,77	na***	3,62	0,00

* indeks obezbojenja izražen kao promjer obezbojenja/promjer kolonije 9. dana uzgoja, odnosno 10. dana uzgoja za *P. chrysosporium* i *T. versicolor* AG 613 na malahitnom zelenilu i metilenskom modrilu
 ** 3. dan uzgoja
 *** na (eng. *not applicable*) nije bilo moguće očitati promjer obezbojenja

Izuzetak je bila gljiva *D. squalens* za koju je primijećen vrlo spor rast i obezbojenje agarnih ploča pri najmanjoj koncentracije malahitnog zelenila u podlozi. Jayasinghe i sur. (2008) također su zabilježili potpuni izostanak rasta na agarnim pločama s malahitnim zelenilom (100 mg L^{-1}) u slučaju 4 od 10 vrsta gljiva bijelog truljenja koje su istraživali, dok su ostale rasle značajno sporije od kontrola, ali su pokazale dobru sposobnost obezbojenja agarnih ploča, što je u skladu s rezultatima dobivenima ovim istraživanjem. Iz tablice 1. nadalje je vidljivo da su odabrane gljive učinkovito obezbojile kristal violet. Manje vrijednosti indeksa obezbojenja u odnosu na malahitno zelenilo, djelomično su posljedica činjenice da je inhibicija rasta ovim bojilom bila manja. Izuzetak je gljiva *C. subvermispora* za koju je vidljivo kako je indeks obezbojenja vrlo visok za sve koncentracije kristal violeta te je ova gljiva ujedno bila i najjače inhibirana dodatkom kristal violeta u podlogu. U sličnom istraživanju koje su proveli Eichlerová i sur. (2006) dodatak kristal violeta u podloge na kojima su uzgajane gljive *P. chrysosporium*, *Pleurotus ostreatus* i *T. versicolor* u koncentracijama od 100 i 500 mg L^{-1} imao je za posljedicu inhibiciju rasta ili potpuni izostanak rasta ovih gljiva. U koncentraciji 50 mg L^{-1} kristal violet je uzrokovao usporeni rast, ali je došlo do obezbojenja podloge. Fuksin je bojilo koje su sve gljive tijekom ovog istraživanja obezbojile do određene mjere, ali je učinkovitost obezbojenja bila nešto manja u odnosu na druga dva bojila iz iste skupine. Jedina gljiva koja je tijekom 10. dana uzgoja pokazala sposobnost obezbojenja metilenskog modrila je *T. versicolor* TV6. Pri tome je vidljiva zona obezbojenja primijećena tek između 6. i 9. dana uzgoja, za razliku od svih ostalih bojila kada je obezbojenje primijećeno već između 2. i 3.

dana uzgoja (rezultati nisu prikazani). Indeks obezbojenja manji od 1 ukazuje na slabiju sposobnost obezbojenja metilenskog modrila pomoću ove gljive u odnosu na sposobnost obezbojenja drugih bojila. Ovo je posebice očigledno kada se uzme u obzir činjenica kako dodatak metilenskog modrila u podloge nije rezultirao značajnijom inhibicijom rasta u odnosu na kontrolu. Kako je metilensko modrilo teško biorazgradljivo bojilo pokazuje i istraživanje Jayasinghe i sur. (2008) u kojem su samo 2 od 10 korištenih gljiva bijelog truljenja pokazale dobru sposobnost obezbojenja metilenskog modrila, odnosno indeks obezbojenja veći od 1. Pri tome je dodatak metilenskog modrila u podlogu za posljedicu imao umjeren do jak inhibitorni učinak na rast odabranih 10 vrsta gljiva bijelog truljenja.

Statistička obrada rezultata rasta kolonija istraživanih gljiva na agarnim pločama s dodatkom bojila ukazuje na sljedeće: bojila djeluju inhibitorno na rast kolonija gljiva, pri čemu veće koncentracije bojila inhibiraju rast kolonija u većoj mjeri (rezultati nisu prikazani). Gotovo redovito je promjer kolonije kontrolnih uzoraka (bez dodatka bojila u podlogu) veći, u usporedbi s promjerom kolonije koja raste na bojilima, što je potvrđeno statističkim testom analize varijance ANOVA uz post-hock Bonterroni-ijev test utvrđivanja razlike između podataka. No, kako kolonije gljiva rastu, tako se i razlika u porastu kontrolnih uzoraka i uzoraka s bojilima smanjuje. Za pretpostaviti je kako se gljiva prilagođava supstratu te, nakon izvjesnog vremena prilagodbe, rast završava slično kao i kontrolni uzorak, bez bojila. S druge strane, većinom nema statistički značajne razlike između obezbojenja ploča s bojilima bez obzira na tri različite koncentracije bojila. Iako je rast gljiva inhibiran dodatkom bojila, čini se kako istražene koncentracije bojila nisu utjecale i na smanjenje ekspresije enzima koji su odgovorni za obezbojenje.

Zaključci

Na osnovu rezultata istraživanja može se zaključiti kako odabrane gljive bijelog truljenja, zbog pokazane sposobnosti potpunog ili djelomičnog obezbojenja korištenih bojila, imaju potencijal za korištenje u bioremedijaciji obojenih otpadnih voda. Nadalje, rezultati također upućuju na potrebu daljnjih istraživanja kako bi se ispitalo utjecaj većih koncentracija bojila na rast kolonija i sposobnost obezbojenja bojila.

Literatura

- Adedayo, O., Javadpour, S., Taylor, C., Anderson, W.A., Moo-Young, M. (2004): Decolourization and detoxification of methyl red bay aerobic bacteria from a wastewater treatment plant, *World J Microbiol Biotechnol.* 20, 545-550.
- Asgher, M., Bhatti, H.N. (2007): Decolorization potential of mixed microbial consortia for reactive and disperse textile dyestuffs, *Biodegradation* 18, 311-316.
- Eichlerová, I., Homolka, L., Nerud, F. (2006): Synthetic dye decolorization capacity of white rot fungus *Dichomitus squalens*, *Bioresource Technol.* 97, 2153-2159.
- Eichlerová, I., Homolka, L., Nerud, F. (2006a): Evaluation of synthetic dye decolorization capacity in *Ischnoderma resinosum*, *J. Ind. Microbiol. Biot.* 33, 759-766.

Zaštita okoliša / Environmental Protection

- Elisashvili, V., Kachlishvili, E., Tsiklauri, N., Metreveli, E., Khardziani, T., Agathos, S.N. (2009): Lignocellulose-degrading enzyme production by white-rot Basidiomycetes isolated from the forests of Georgia, *World J Microbiol Biotechnol.* 25, 331-339.
- Eshghia, H., Alishahib, Z., Zokaieb, M., Daroodia, A., Tabasib, E. (2011): Decolorization of methylene blue by new fungus: *Trichaptum biforme* and decolorization of three synthetic dyes by *Trametes hirsuta* and *Trametes gibbosa*, *Eur. J. Chem.* 2, 463-468.
- Forgacs, E., Cserhati, T., Oros, G. (2004): Removal of synthetic dyes from wastewaters: a review, *Environ Int.* 30, 953-971.
- Gudelj, I., Hrenović, J., Landeka Dragičević, T., Delaš, F., Šoljan, V., Gudelj, H. (2011): Azo boje, njihov utjecaj na okoliš i potencijal biotehnoške strategije za njihovu biorazgradnju i detoksifikaciju, *Arh Hig Rada Toksikol.* 62, 91-101.
- Gupta, V.K., Suhas (2009): Application of low-cost adsorbents for dye removal--a review, *J Environ Manage.* 90, 2313-2342.
- Jayasinghe, C., Imtiaj, A., Lee, G.W., Im, K.H., Hur, H., Lee, M.W., Yang, H.S., Lee, T.S. (2008): Degradation of three aromatic dyes by white rot fungi and the production of ligninolytic enzymes, *Mycobiology* 36, 114-120.
- Sandhya, S., Padmavathy, S., Swaminathan, K., Subrahmanyam, Y.V., Kaul, S.N. (2005): Microaerophilic-aerobic sequential batch reactor for treatment of azo dyes containing simulated wastewater, *Process Biochem.* 40, 885-90.
- Santos, G.C., Corso, C.R. (2014): Comparative Analysis of Azo Dye Biodegradation by *Aspergillus oryzae* and *Phanerochaete chrysosporium*, *Water Air Soil Pollut.* 225, 2026.
- Saratale, R.G., Saratale, G.D., Chang, J.S., Govindwar, S.P. (2011): Bacterial decolorization and degradation of azo dyes: A review, *Journal of the Taiwan Institute of Chemical Engineers.* 42, 138-157.
- Wesenberg, D., Kyriakides, I., Agathos, S.N. (2003): White-rot fungi and their enzymes for the treatment of industrial dye effluents, *Biotechnol. Adv.* 22, 161-187.

Original research paper

Synthetic dyes decolourisation on agar plates by selected fungi

Natalija Velic^{1*}, Hrvoje Pavlović¹, Mirjana Pavičić¹, Antonija Kezerle²

¹Josip Juraj Strossmayer University of Osijek, Faculty of Food Technology Osijek,
F. Kuhača 20, 31 000 Osijek, Croatia

²Vodovod-Osijek d.o.o., Poljski put 1, 31000 Osijek, Croatia

*Corresponding author: natalija.velic@ptfos.hr

Summary

Four white rot fungi *P. chrysosporium* CCBAS 570, *T. versicolor* CCBAS AG613, *T. versicolor* TV6 and *C. subvermispora* were tested for their ability to decolourise synthetic dyes (Malachite Green MG, Crystal Violet CV, Fuchsine F and Methylene Blue MB). Fungal species were cultivated at 27 °C for 9 (10) days on Potato dextrose agar plates containing dyes at final concentrations of 50, 100 and 150 mg L⁻¹. The colony radial growth and the decolourisation zone (in two perpendicular directions) were measured every three days. Although all fungal strains were strongly inhibited by MG, high decolourisation index (decolourisation diameter/mycelial diameter) ranging from 2.42 to 6.04 for all tested species indicated very good decolourisation ability. CV strongly inhibited the growth of all fungi except *P. chrysosporium*. However, all species partially decolourised CV. F was also decolourised by all strains but the decrease in decolourisation efficiency was observed (decolourisation index ranging from 0.24 to 1). Inhibitory effect of F to fungal growth was observed only during the first cultivation days. Only *T. versicolor* TV6 partially decolourised MB, even though this dye did not inhibit the mycelial growth of the tested fungal strains. The influence of agar plate dye concentration on fungal growth was statistically significant, while no statistical significance was observed regarding the decolourisation ability.

Keywords: synthetic dyes, *P. chrysosporium*, *T. versicolor*, *C. subvermispora*, decolourisation

Original research paper

Iron-modified zeolite as a sorbent for nitrate and phosphate removal from water systems

Marin Ugrina^{*}, Nediljka Vukojević Medvidović, Marina Trgo, Ivona Nuić

*University of Split, Faculty of Chemistry and Technology,
Ruđera Boškovića 35, 21000 Split, Croatia
^{*}Corresponding author: mugrin@ktf-split.hr*

Summary

The discharge of effluents bearing nitrogen and phosphorus into the water body causes the eutrophication phenomenon, which leads to restrictions in the use of water sources. Different physical, chemical and biological methods have been developed and applied for their removal. Recent scientific investigations have been focused on the application of abundant naturally occurring low-cost materials, such as natural zeolites and their modifications that allow for the removal of anionic species.

This paper has focused on the investigation of the feasibility of iron-modified zeolite (IMZ) as a sorbent for nitrates and phosphates from water solutions. The influence of the initial pH and concentration of the solution on the sorption efficiency of nitrates and phosphates on IMZ has been investigated. Higher removal efficiency of phosphates has been observed on IMZ than of nitrates. It has been found that phosphate and nitrate removal efficiency depends on the point of zero charge of the material and the pH of the solution. The additional benefit of the IMZ application in phosphate and nitrate removal is the possibility of subsequent use of saturated IMZ as fertilizer.

Keywords: sorption, iron-modified zeolite, nitrates, phosphates

Introduction

Nitrogen and phosphorus compounds are essential nutrients and play important roles in agriculture. Uncontrolled discharges of industrial wastewaters as well as excessive use of fertilizers in agricultural activities lead to leaching of phosphates and nitrates from agricultural land causing them to penetrate into water streams (surface waters, ground waters). High amounts of these compounds in surface waters promote eutrophication resulting in excessive algal growth and oxygen depletion causing fish kills (Morghi et al., 2015; Zamparas et al., 2011; Hamdi and Srasra, 2012; Zhang and Tian, 2015). Common methods for nitrate removal include biological nitrification-denitrification and chemical reduction, while for phosphates they include biological removal and chemical precipitation with iron salts. In addition, all these methods have their own limitations such as the required pH and production of chemical sludge (Morghi et al., 2015; Azari et al., 2014; Fang et al., 2014; Montalvo, 2011). These methods are effective in removing phosphates and nitrates to mg/l levels but not always to µg/l ones (Reed et al., 2000).

For low concentration removal, sorption processes and membrane techniques are taken into account. Among them, sorption processes are generally considered to be the simplest due to relative simplicity of operation and use of low cost naturally occurring materials like natural zeolites. Natural zeolites are already recognized as efficient sorbent materials for different toxic substances from wastewater, especially for cationic species like heavy metals because they have a negative charge caused by substitution of Si^{4+} by Al^{3+} . In order to remove anionic species, simple surface modifications are performed which improve their sorption capacities. Many studies have focused on investigation of environmentally friendly natural materials for nitrate removal such as modified natural clinoptilolites (Pavlović et al., 2014), chitin (Morgi et al., 2015), modified clinoptilolite (Azari et al., 2014), modified analcime (Faghihian et al., 2001), natural zeolite (Montalvo, 2011), and for phosphate removal, modified bentonites (Zamparas et al., 2011), magnesium modified corn biochar (Fang et al., 2014), lanthanum modified zeolite (Zhang and Tian, 2015), natural zeolite (Montalvo, 2011), modified zeolite (Panayotova, 2015) and calcite (Karageorgiou, 2012). In this paper, the feasibility of using iron-modified zeolite as a sorbent for nitrate and phosphate removal has been examined. In this sense, the effect of the initial pH and concentration of the solution on the sorption efficiency has been investigated.

Materials and Methods

Sample preparation

The natural zeolite (NZ) from the Vranjska Banja deposit, Serbia, with the particle size of 0.6-0.8 mm, was used as the starting material for preparation of the iron-modified zeolite (IMZ). Before modification, NZ was washed in ultrapure water to remove impurities and dried at 60°C. The modifications were performed through three separate stages: in the aqueous solution of 1 mol/l $\text{Fe}(\text{NO}_3)_3 \cdot 9\text{H}_2\text{O}$ prepared in acetate buffer at pH=3.6, followed by 1 mol/l NaOH and 4% NaNO_3 solutions. The prepared sample was dried at 40°C and kept in a desiccator until use. Physical-chemical characterization of IMZ has been performed and explained in detail in a previously published paper (Ugrina et al., 2015).

Sorption experiment

The effect of the solution pH and initial concentration on the sorption efficiency of phosphates and nitrates on iron-modified zeolite was examined by the batch technique. All experiments were performed in the same manner. 1.0000 g of IMZ was mixed with 100 ml of phosphate or nitrate solution in a batch reactor at 250 rpm, for 48 hours at ambient temperature. After equilibration, the suspensions were filtered and the remaining concentration of anions was determined by means of the ion chromatography method and the equilibrium pH was measured. The solutions were prepared by dissolving the appropriate amount of K_3PO_4 or KNO_3 salts in ultrapure water. The effect of the solution pH was studied over the pH range 2-12. The initial pH was adjusted by a small addition of 0.1 mol/l HNO_3 for phosphates and 0.1 mol/l HCl for nitrates or 0.1 mol/l KOH. The initial concentrations of the phosphate and nitrate solution were 100 mg $\text{PO}_4^{3-}/\text{l}$ and 100 mg NO_3^-/l , respectively. The effect of initial concentrations was investigated at $\gamma_o=5-400$ mg $\text{PO}_4^{3-}/\text{l}$ and three different pH_o (2.55, 7.01, 12.01) while for nitrates at the same initial concentration, $\gamma_o=5-400$ mg NO_3^-/l without adjusting pH ($\text{pH}_o=6.48$).

Zaštita okoliša / Environmental Protection

The amount of sorbed anions in equilibrium, q_e (mg/g) and the sorption efficiency, α (%) were calculated by means of equations:

$$q_e = (\gamma_o - \gamma_e) \cdot \frac{V}{m} \quad (1)$$

$$\alpha = \frac{(\gamma_o - \gamma_e)}{\gamma_o} \cdot 100 \quad (2)$$

where γ_o and γ_e are initial and equilibrium concentrations of anions (mg/l), V is the volume of the solution (l) and m is the mass of zeolite (g).

Results and Discussion

Effect of pH

The pH of the solution is an important parameter which controls the sorption of ions at the zeolite-water interfaces. Also, most sorbent/sorbate systems exhibit some short pH-dependent behaviour due to the chemistry of the sorbate and sorbent (Reed et al., 2000). Therefore, the effect of pH_o on the amount of sorbed phosphates and nitrates onto IMZ, q_e and the sorption efficiency, α , were investigated in the pH range 2-12 and are shown in the Figure 1.

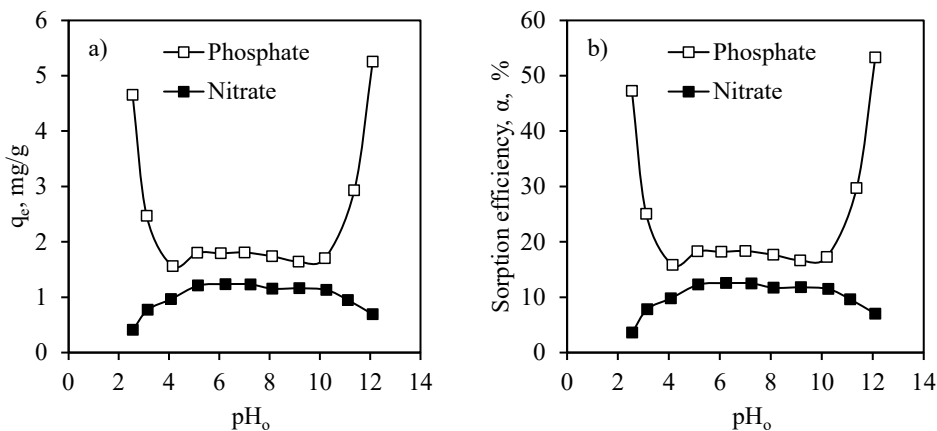

Fig. 1. a) The amount of phosphates and nitrates sorbed per gram of IMZ vs. pH_o ; b) The sorption efficiency, α of phosphate and nitrate sorption on IMZ vs. pH_o

In the pH range of $pH_o=5-10$ the minimum value of q_e and α for phosphates and the maximum value for nitrates is observed. Outside of this pH range, the decrease of q_e and α for nitrates and increase for phosphates is noticed. Also, during experiments, pH values of suspensions were measured continuously and the results are shown in Figure 2.

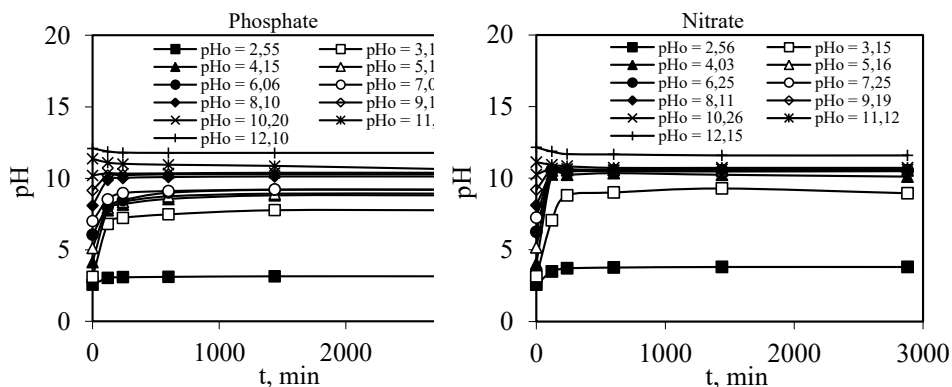
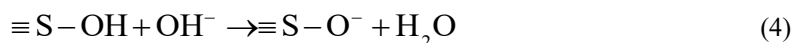

Fig. 2. The measurement of pH during phosphate and nitrate sorption on IMZ

Both anions show a similar pH profile. The increase of pH for $pH_0 \sim 2.5$ is negligible, while for $pH_0 = 3-9$ the increase is up to $pH = 8-10$. At $pH_0 = 11$ and 12, a slight decrease in pH is observed. The increase and decrease of pH values is the consequence of zeolite-aqueous nitrate or phosphate anion interactions as well as the competition effect with H^+ and OH^- ions. This behaviour could be connected with the anionic species and the zeolite surface charge depending on the solution pH, as well as on chemical interactions and electrostatic forces between IMZ and anions.

It is known that zeolites possess a net surface charge which varies depending on the pH of the solution. In acid and basic conditions, protonation and deprotonation reactions of functional zeolite groups take place as follows (Trgo and Perić, 2003):



where S is Si, Al or Fe. In order to know the net surface charge of IMZ, in a previous paper the point of zero charge of IMZ, pH_{pzc} has been determined: it occurs at $pH_{pzc} = 9.8 \pm 0.1$ (Ugrina et al., 2015). This means that IMZ is positively charged below pH of pH_{pzc} due to Eq. 3, while above the pH_{pzc} value IMZ has a negative charge according to Eq. 4.

In the case of nitrate sorption on IMZ, the maximum q_e and α are obtained at the pH range, $pH_0 = 5-10$ and equal 1.2 mg/g and 13%, respectively. The same pH effect for nitrate removal onto modified zeolite clinoptilolite has been observed by Azari et al. (Azari et al., 2014). The lower sorption efficiency in a highly acidic medium is probably due to the competition effect with H^+ ions while in a basic medium it is due to the competition with OH^- ions or repulsion forces between negative surface charges of IMZ and nitrate ions (Azari et al., 2014; Fang et al. 2014). Thus, the main mechanism of nitrate sorption in the pH range 5-10 stems from electrostatic attraction between negative nitrate ions and positive zeolite surfaces. Phosphoric acid is weak and yields hydrolysed products, depending on pH. Table 1 summarizes hydrolysis reactions with the corresponding constants and Figure 3 shows the distribution of phosphate species as a function of pH.

Table 1. Hydrolysis constants for phosphate hydrolysis reactions (Kester and Pytkowicz, 1967)

Hydrolyses reactions	K_a
$\text{PO}_4^{3-} + \text{H}_2\text{O} \rightleftharpoons \text{HPO}_4^{2-} + \text{OH}^-$	$7.52 \cdot 10^{-3}$
$\text{HPO}_4^{2-} + \text{H}_2\text{O} \rightleftharpoons \text{H}_2\text{PO}_4^- + \text{OH}^-$	$6.23 \cdot 10^{-8}$
$\text{H}_2\text{PO}_4^- + \text{H}_2\text{O} \rightleftharpoons \text{H}_3\text{PO}_4 + \text{OH}^-$	$4.80 \cdot 10^{-13}$

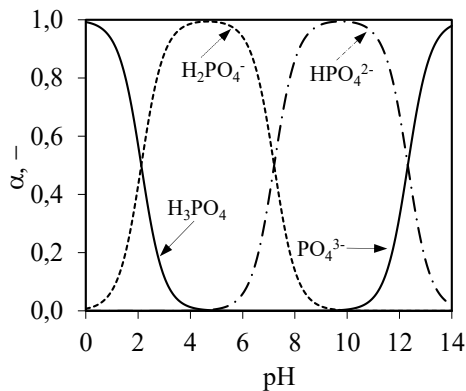
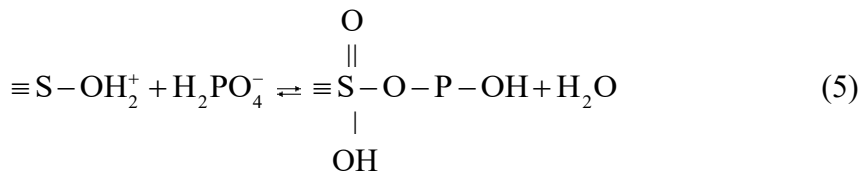

Fig. 3. Distribution of phosphate species as a function of pH based on hydrolysis constants listed in Table 1

The results from Figure 1 show that pH is an important parameter in the removal of phosphate anions. The maximum efficiency is achieved in boundary conditions, acidic and basic. According to Figure 3, at pH=2-4, the dominant phosphate species is H_2PO_4^- . Higher sorption efficiency in this region could be attributed to electrostatic attraction between H_2PO_4^- and positive binding sites on IMZ and then chemical interaction according to the reaction (Hamdi and Srasra, 2012):



At $\text{pH} > \text{pH}_{\text{pzc}}$, the net surface charge of IMZ is negative and HPO_4^{2-} and PO_4^{3-} species are present in solution. In these conditions, repulsive electrostatic forces are produced between phosphate anions and IMZ. The cause of increase in sorption efficiency at pH values higher than $\text{pH}_0=10$ could be attributed to chemical interaction forces which must be greater than the repulsive electrostatic force. A similar effect has been observed by Panayotova (2015), Reed et al. (2000), Valazquez-Peña et al. (2015) and Karageorgiou et al., (2012).

Allred (2010) described the removal of PO_4^{3-} on activated carbon in basic conditions by the exchange of phosphate anions with oxygen-containing functional groups, where anions become incorporated into the surface of the substrate. Huang et al. (2003) and Tyrvola et al. (2006) described the removal of PO_4^{3-} on iron oxide/hydroxide via ligand exchange. For the pH range 5-10, sorption could be attributed to both electrostatic and chemical interactions.

Effect of initial concentration

A previous experiment has shown that the optimal pH for nitrate removal is $\text{pH}_0=5-10$, while phosphate anions behave differently. Due to this reason the effect of the initial concentration on phosphate sorption has been examined at three different pH_0 values (2.55, 7.02, 12.01) and for nitrates in the pH range 5-10, without adjusted pH, $\text{pH}=6.48$. Figure 4 shows the effect of the initial concentration on the amount of phosphates and nitrates sorbed on IMZ as well as the sorption efficiency.

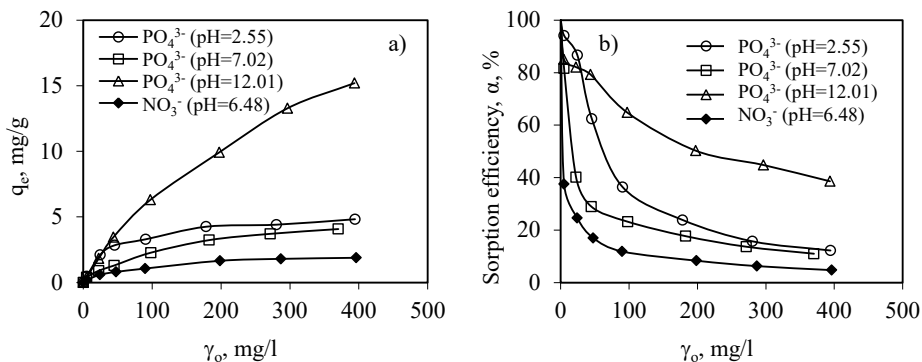

Fig. 4. a) The amount of phosphates and nitrates sorbed per gram of IMZ vs. γ_o . b) α_e vs. γ_o for phosphate and nitrate sorption vs. γ_o

The amount of phosphates and nitrates sorbed on IMZ increases with the increase in the initial concentration while the sorption efficiency decreases. It has been found that an increase in pH has a significant effect on phosphate sorption and higher sorption efficiency of phosphates on IMZ than on nitrate sorption. The results show that the maximum q_e and α obtained for phosphates equal 5 mg/g or 12% ($\text{pH}=2.55$), 4 mg/g or 11% ($\text{pH}=7.02$) and 15 mg/g or 39% ($\text{pH}=12.01$), while for nitrates 2 mg/g or 5% ($\text{pH}=6.48$). The three times higher removal is achieved for phosphates at $\text{pH}=12.01$ then that at lower pH values. Maximum permissible values for phosphates and nitrates in wastewaters according to Croatian legislation are 1 mg $\text{PO}_4^{3-}/\text{l}$ and 2 mg NO_3^-/l , respectively. Results from Figure 4 also indicate that for the initial concentration of 5 mg/l for both anions, the residual concentrations are below maximum permissible values with sorption efficiency higher than 80% for phosphates at all three pH_0 and 37% for nitrates. This suggests that IMZ is a good sorbent for low concentrations of these anions in wastewaters. For higher concentration, higher mass of IMZ should be used. For this purpose Langmuir and Freundlich isotherm models have been applied to design a batch reactor in order to assess the required mass of zeolite.

Zaštita okoliša / Environmental Protection

Batch scale design

In order to predict the required mass of zeolite for the given sorption efficiency a single-stage batch sorption system has to be designed. The mass balance in a batch reactor is given by Eq. (6):

$$V \cdot (\gamma_o - \gamma_t) = m \cdot (q_t - q_o) \quad (6)$$

When system reaches the equilibrium, γ_t and q_t will change to γ_e and q_e , respectively. If $q_o=0$, Eq. (6) becomes:

$$V \cdot (\gamma_o - \gamma_e) = m \cdot q_e \quad (7)$$

The q_e from Eq (7) can be substituted with isotherm that shows the best fit. Therefore, the experimental sorption data correlated with Langmuir and Freundlich isotherms are presented in Figure 5 and the corresponding constants are summarized in Table 2.

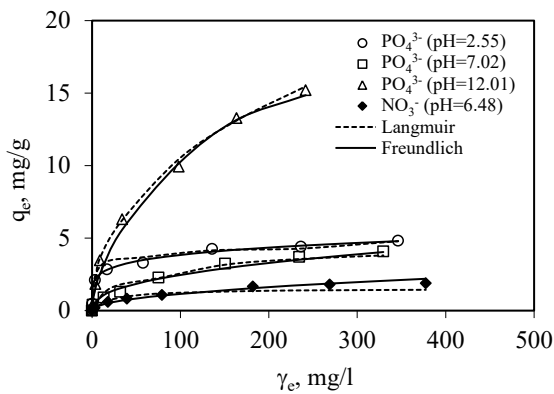

Fig. 5. Langmuir and Freundlich isotherm models fit for phosphate and nitrate sorption on IMZ
Table 2. The constants of Langmuir and Freundlich isotherms.

Model	Parameter	Phosphates			Nitrates
		pH=2.55	pH=7.02	pH=12.01	pH=6.48
	q_{exp}	4.825	4.075	15.200	1.884
Langmuir equation	q_o	4.010	3.827	14.299	1.518
	K_L	0.477	0.060	0.052	0.045
	r^2	0.988	0.980	0.973	0.979
Freundlich equation	K_F	1.701	0.365	0.684	0.126
	n_F	5.650	2.413	1,682	2.078
	r^2	0.996	0.996	0.999	0.991

According to the isotherm parameters and correlation coefficients, r^2 a better fit is observed with the Freundlich isotherm. Since the Freundlich isotherm showed the best fit with the experimental data, Eq. (6) is rearranged as:

$$V \cdot (\gamma_o - \gamma_e) = m \cdot K_F \cdot \gamma_e^{1/n_F} \quad (8)$$

that is:

$$m = \frac{V \cdot (\gamma_o - \gamma_e)}{K_F \cdot \gamma_e^{1/n_F}} \quad (9)$$

Eq. (9) provides for a calculation of the mass of IMZ needed for a given volume of solution, initial concentration and percentage of sorption efficiency. Figure 6 presents the needed mass of IMZ against volume of solution for the desired initial concentration of nitrates and phosphates to achieve sorption efficiency of 90%.

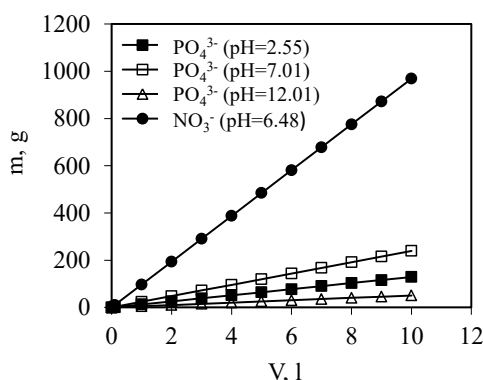

Fig. 6. IMZ mass vs. volume of metal solution for 90% sorption efficiency and initial concentration of 9.5 mg PO₄³⁻/l and 18 mg NO₃⁻/l

Results indicate that in order to reduce the concentration of phosphates and nitrates below the maximum permissible values with sorption efficiency of 90%, the maximum initial concentration should not be higher than 9.5 mg PO₄³⁻/l and 18 mg NO₃⁻/l. Iron-modified zeolite has showed to be a good material for removal of low concentration of nitrates and phosphates. Thus, further investigations should focus on testing the use of saturated zeolite as fertilizer.

Conclusions

The sorption of phosphates and nitrates onto iron-modified zeolite is quite a complex process depending on pH. The results indicate that pH has a strong effect as it determines the type of anionic species, zeolite surface charge as well as chemical interactions and electrostatic forces between IMZ and anions. Two processes effect on the sorption: chemical interactions and electrostatic forces accompanied by the competition effect with H⁺ and OH⁻ ions. The maximum sorption efficiency is achieved in the pH range 5-10 for nitrates, and in acidic and basic conditions for phosphates.

To reduce the concentration of nitrates and phosphates below maximum permissible values the application of batch scale design has showed that the initial concentration should not exceed the value of 9.5 mg PO₄³⁻/l and 18 mg NO₃⁻/l. Thus, iron-modified zeolite is a promising material for removal of low concentrations of nitrates and phosphates.

References

- Allred, B. J. (2010): Laboratory batch test evaluation of five filter materials for removal of nutrients and pesticides from drainage waters, *ASABE* 53 (1), 39-54.
- Azari, A., Mahvi, A. H., Naseri, S., Kalantary, R. R., Saberi, M. (2014): Nitrate removal from aqueous solution by using modified clinoptilolite zeolite, *Arch Hyg Sci* 3 (1), 184-192.
- Can. M., Bulat, E., Örnek, A. (2015): A batch adsorber design for rhodium adsorption on gallic acid formaldehyde resin, *Acta Phys. Pol. A* 127, 1311-1313.
- Fang, C., Zhang, T., Li, P., Jiang, R., Wang, Y. (2014): Application of magnesium modified corn biochar for phosphorus removal and recovery from swine wastewater, *Int. J. Environ. Res. Public Health* 11, 9217-9237.
- Faghihian, H., Mostafavi, A., Mohammadi, A. (2001): Surface modification of analcime for removal of nitrate from aqueous solutions, *J. Sci. I. R. Iran* 12 (4), 327-322.
- Hamdi, N., Srasra, E. (2012): Removal of phosphate ions from aqueous solution using Tunisian clays minerals and syntetic zeolite, *J. Environ. Sci.* 24 (4), 617-623.
- Karageorgiou, K., Paschalis, M., Anastassakis, G. N. (2007): Removal of phosphate species from solution by adsorption onto calcite used as natural adsorbent, *J. Hazard. Mater.* 139, 447-452.
- Kester, D. R., Pytkowicz, R. M. (1967): Determination of the apparent dissociation constants of phosphoric acid in seawater, *Limnol. Oceanog.* 12 (2), 243-252.
- Montalvo, S. L., Guerrero, L. E., Milán, Z., Borja, R. (2011): Nitrogen and phosphorus removal using a novel integrated system of natural zeolite and lime, *J. Environ. Sci. Health* 46 (12), 1385-1391.
- Morghi, M., Abidar, F., Soudani, A. Zerbet, M., Chiban, M. Kabli, H., Sinan, F. (2015): Removal of nitrate ions from aqueous solution using chitin as natural sorbent, *Int. J. Environ. Stud.* 2, 8-20.
- Panayotova, M. (2015): Nutrients removal from wastewater using modified zeolite, *Sustainable Development*, 1 (22), 99-104.
- Pavlović, J., Milenković, J. Rajić, N. (2014): Modification of natural clinoptilolite for nitrate removal from aqueous media, *J. Serb. Chem. Soc.* 79 (10), 1309-1322.
- Reed, B. E., Vaughan, R., Jiang, L. (2000): As(III), As (V), Hg, and Pb removal by Fe.oxide impregnated activated carbon, *J. Environ. Eng.* 126, 869-873.
- Trgo, M., Perić, J. (2003): Interaction of the zeolitic tuff with Zn-containing simulated pollutant solution, *J. Colloid Interface. Sci.* 260, 166-175.
- Valazquez-Peña, G., C., Solache-Ríos, M., Martínez-Miranda, V. (2015) Competing Effects of Chloride, Nitrate, and Sulfate ions on the removal of fluoride by a modified zeolitic tuff, *Water Air Soil Poll.* 226, 2236-2251.
- Zamparas, M. Stathi, P., Deligiannakis, Y., Zacharias, I. (2011): Removal of phosphate from natural waters using modified bentonites. In: Proceedings of the 3rd International Conference on Environmental Management, Engineering, Planning and Economics (CEMEPE 2011) & SECOTOX Conference, Shiatkos, Kungolos, A., Karagiannidis, A., Aravossis, K., Samaras, P., Schramm, K. W. (eds.) pp. 1011-1014.
- Zhang, W., Tian, Y. (2015): Phosphorus removal from wastewater by lanthanum modified Y zeolites, *Front. Chem. Sci. Eng.* 9 (2), 209-215.

Heavy metals removal from compost leachate using zeolite

Marjana Simonič^{1*}, Lidija Fras Zemljic²

¹University of Maribor, Faculty of Chemistry and Chemical Engineering,
Smetanova 17, 2000 Maribor, Slovenia

²University of Maribor, Faculty of Mechanical Engineering, Smetanova 17, 2000 Maribor, Slovenia

*Corresponding author: marjana.simonic@um.si

Summary

The purpose of this study was to remove heavy metals from compost leachate using zeolite, and lime. Our goal was to achieve less than 0.5 mg/l of Cu^{2+} and less than 2 mg/l of Zn^{2+} in the treated compost leachate. The physico-chemical parameters: *pH*, metal content, total organic carbon and total nitrogen were measured. After filtration the adsorption of metals from compost leachate on zeolite was studied. The best results were obtained after combined adsorption on zeolite, activated charcoal and lime (*pH*=10). Zn^{2+} content in the compost leachate decreased from 2.71 mg/l to 0.53 mg/l, which was a 80.4 % decrease. Although compost leachate contained low concentrations of Cu^{2+} (0.23 mg/l), Cu^{2+} was most effectively removed using the zeolite and lime at *pH*=10. The Cu^{2+} content decreased from 0.23 mg/l to 0.08 mg/l, which represented 65% reduction. We have found that the *pH* effected the cleaning of a compost leachate since the results at *pH* = 9 were worse. The results showed that organic content in compost leachate had a huge impact on metal removal using zeolite.

Keywords: compost leachate, metal removal, zeolite, lime

Introduction

Composting is popular method for treatment of waste. Large number of leachate is generated from the release of water during the decomposition of the green waste. The composition of leachate is very complex and could pose a risk for environment due to heavy metal content. Adsorbents, such as zeolites, are used for metal removal. Clinoptilolite is a type of natural zeolite in form of hydrated aluminosilicates. Clinoptilolite is very efficient for heavy metal removal in sequence: $\text{Pb}^{2+} > \text{Ni}^{2+} > \text{Cu}^{2+} > \text{Cd}^{2+} > \text{Zn}^{2+} > \text{Cr}^{3+} > \text{Co}^{2+}$. (Tabatabaei et al 2012). Another study reported about the adsorption of metal ions on natural zeolites clinoptilolite and chabazite, which were used for removal of several ions, such as Pb^{2+} , Cu^{2+} , Zn^{2+} , Co^{2+} , Cd^{2+} , Ni^{2+} . Both zeolites successfully removed all enumerated ions with the initial concentration of 10 mg/l (Babel and Kurniawan, 2003). Sewage sludge compost leachate was treated by the combination of zeolite and activated carbon (Delkash et al, 2015). Activated carbon adsorbed a lot of hydrophobic organic compounds, due to its non-polar nature. Zeolite is more hydrophilic and adsorbed ionic species. As combination those were proved to be very efficient. Lime was used for adjusting *pH* to alkaline value which is favourable for metal ions removal. Further, lime is inexpensive.

Zaštita okoliša / Environmental Protection

The removal of metals such as Pb^{2+} , Zn^{2+} and Cd^{2+} are very sensitive to pH value Pb^{2+} was mostly removed in acid pH value, while Zn^{2+} and Cd^{2+} in alkaline range. Pb^{2+} was successfully removed at $\text{pH}=5.5$ at 99.9 % while a little lower percentage of 99.5 % was achieved at $\text{pH}=2.2$. Removal efficiencies for Zn^{2+} and Cd^{2+} at 93.6 % and 85.8 %, respectively, in alkaline range. the efficiencies decreased to 23.4 % and 21 % in acid pH range. (Delkash et al, 2015)

The aim of this study was to remove heavy metal ions from compost leachate after composting of kitchen waste. The main focus was directed towards removal of Cu^{2+} and Zn^{2+} using zeolite and lime. We stick to the values determined in Slovene legislation as maximum allowed values for leachate release. pH was adjusted and different mass of zeolite were studied with a goal to remove metal ions in model solutions. pH was also adjusted using lime, which was assumed to increase the removal efficiency. The real compost leachate was treated at optimal conditions.

Materials and Methods

Zeolites used for Zn^{2+} and Cu^{2+} removal from water are presented in Fig. 1. Two types of zeolite A were tested: in powdered form (ZAP) and granular one (ZAG). Both were purchased from Silkem, Slovenia. The pore diameter of zeolite A was 20 nm. Empirical formula of hidratized zeolite A is $\text{Na}_{12}(\text{SiO}_2)_{12}(\text{AlO}_2)_{12} \cdot 27 \text{H}_2\text{O}$ (CNSI, 2016). The structure of zeolite is seen from Fig. 2.



Fig. 1. Zeolites: powdered zeolite (ZAP) and granulated (ZAG)

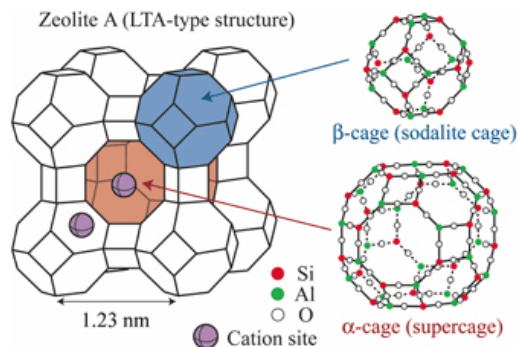

Fig. 2. Structure of zeolite A (CNSI, 2016)

Physico-chemical properties of zeolite A are presented in Table 1 (MSDS, 2016) and were the same for powdered and granular zeolite A.

Table 1. Physico-chemical properties of zeolite A

State of matter	solid
Color	white
Smell	non
pH	10.5 - 11
Density	200 – 800 kg/m ³
Solubility in water	no

Granular activated carbon, Filtrasorb 400M, was purchased from Chemviron, with the effective size 0.55-0.75 mm, density 0.54 g/cm³. Lime was donated by local company.

Analytical methods

Physico-chemical parameters of model water and treated model water as well as of untreated and treated compost leachate were determined. pH and conductivity (χ) were determined using WTW Multi pH/Cond 340i instrument. Atomic absorption spectroscopy (AAS) using PERKIN ELMER 1100 B spectro-photometer was performed for determination of Zn²⁺, Cu²⁺ and Ni²⁺ concentrations. Due to high concentration in compost leachate, the digestion was necessary before AAS in concentrated HNO₃ (5 % V/V). Cr⁶⁺ ions were determined spectrophotometrically using Agilent 8453 UV-visible Spectroscopy System. Total organic carbon (TOC) and total nitrogen (TN) were determined using TOC/TN analyser Multi N/C 2100/2100S Analytik Jena.

Model solution

In the first part of the research, model solutions of Zn²⁺ and Cu²⁺ ions were prepared and treated with zeolites. Model solutions were prepared by dissolving 100 mg/L Cu-ions and 100 mg/L of Zn-ions in 1 L flask. 100 mL aliquots of such solutions were prepared and different amount of zeolite was added: 0.5 g, 1 g, and 2 g of zeolite in powdered form (ZAP) and granular zeolite (ZAG). The influence of pH was studied. pH was adjusted to 4, 5, 6, 7 and 8 using HCl or NaOH. The same procedure was adopted with ZAG. In the next step pH was adjusted to values 9 and 10 using lime instead of NaOH.

Compost leachate

In the second part of research, zeolites were used to remove Zn²⁺ and Cu²⁺ ions from compost leachate. Compost contained wetted organic matter from kitchen waste (leaves, food waste). From the compost pile at composting company Kogal (Slovenia) the water passed into the stabilization ponds. Compost leachate samples were taken three times during 3 weeks from such ponds. The leachate was brown coloured and had unpleasant smell. Also flies were denoted in samples. Leachate contained a lot of organic substances which are dissolved or undissolved in solution. Leachate analysis is presented in Table 2.

Table 2. Parameters of compost leachate

Parameter	Unit	Value
<i>pH</i>	/	6.4
χ	mS/cm	24.3
γ (Cu ²⁺)	mg/L	0.4-5
γ (Zn ²⁺)	mg/L	6.1-10
γ (Ni ²⁺)	mg/L	0.75
γ (Cr ⁶⁺)	mg/L	0.49
<i>TOC</i>	mg/L	13840
<i>TN</i>	mg/L	1380

Organic particles in compost leachate interacts with zeolite and this way compete with the metal ions for available sites on zeolite (Malamis and Katsou, 2013). Therefore, the adsorption ability of zeolite is limited. In order to improve the adsorption ability, the organic material was partly removed by centrifugation using Eppendorf Centrifuge 5804 R, at 3000 rpm. for 5 min. For pH adjustment in supernatant after centrifugation of compost leachate either 0.1 M NaOH or lime was used. Lime is preferred choice over other bases due to its low cost and ease of handling. (Fu and Wang, 2011).

Results and Discussion

The aim of the research was to remove metals from compost leachate. Table 2 showed that concentration of Zn²⁺ and Cu²⁺ oscillated, while the concentrations of Ni²⁺ and Cr⁶⁺ are low. Therefore, firstly model solutions with Zn²⁺ and Cu²⁺ were prepared and treated using zeolite, then real compost leachate was treated with zeolites. Two types of Zeolite A were tested: one in powdered form and another in granular form. Table 3 presents the results of the analyses in water samples. The amount of ZAP or ZAG was 0.5 g for 100 mL of ions solution. It can be observed that pH value had significant influence on Zn-ions removal if ZAG was used. However, the effluent concentrations did not decrease below 0.6 mg/100 mL.

Table 3: Results of the analyses in model solutions

Sample	pH	χ_{Zn} [mg/100 mL]	χ_{Cu} [mg/100 mL]
ZAP	4	< 0.1	< 0.1
	5	< 0.1	< 0.1
	6	< 0.1	< 0.1
	7	< 0.1	< 0.1
	8	< 0.1	< 0.1
ZAG	4	2.8	< 0.1
	5	2.5	< 0.1
	6	2.2	< 0.1
	7	1.9	< 0.1
	8	0.6	< 0.1

ZAP was better choice for Zn-ions removal, while the concentration decreased to 0.2 mg/100 mL of Zn-ions solution. Experiments with ZAP and ZAG showed that the concentration of Cu-ions decreased from 10 mg/100 mL below 0.1 mg/100 mL of Cu ions. The same results for Cu-ions removal was obtained with amount of ZAP 1 g and 2 g per 100 mL of ion solutions. In the case when Zn-ions were treated with zeolite, the same results were achieved with ZAP. The increased amount of ZAG had positive influence on Zn-ions removal. If 1 g per 100 mL of ZAG was added the concentration decreased from 10 mg to 0.5 mg, 0.4 mg, 0.3 mg, 0.2 mg and 0.2 mg at pH 4, 5, 6, 7, and 8, respectively. If 2 g per 100 mL were added results were better and the concentrations decreased below 0.2 mg regardless of pH value. Based on results it can be concluded that ZAP is better type of zeolite for metals removal.

Results for real leachate treatment

Samples were taken and the concentration of metals were determined at 5 mg/L for Zn²⁺ and 0.5 mg/L Cu²⁺. The appropriate concentration determined with model solutions was 2 g per 100 mL of model sample.

Compost leachate contained a lot of organic compounds, which could hinder the adsorption capability of zeolite by blocking the zeolite's pores. Therefore, leachate was centrifuged first in order to remove most of the suspended organic material and enable the adsorption. In the next step, zeolite was added into supernatant. Without centrifugation, we did not achieve any metal removal after adding 2 g of zeolite, while final concentrations of both metals remained the same as their initial concentrations. The pH value of supernatant after centrifugation was adjusted to 8 using 0.1 M NaOH and then using lime to pH=10. Also the amount of zeolite was increased from 2 g to 4 g. The treatment only with zeolite without lime gave worse results while the decrease was to 3.1 mg/L. The second sample contained 2.1 mg/L Zn. The best result was achieved with the amount of zeolite 4 g per 100 mL of sample, 1 g of activated carbon, following with the adjustment at pH=10 by lime only. The removal efficiency was calculated at 80.4 %, the concentration decreased to 0.53 mg/L. The results showed that although some organic matter was removed, majority share of organic matter remained in supernatant and still showed a huge impact on metal removal.

Results of the Zn removal from the third samples of compost leachate were similar to the second one, except that the concentrations of Zn²⁺ in initial samples were determined at 6 mg/L. The efficiency did not exceed 80 %.

Initial concentration of 0.5 mg/L Cu-ions was very low in all three compost leachate samples. The concentration decreased from 0.23 mg/l to 0.08 mg/L after the treatment using zeolite, activated carbon and lime (and/or NaOH).

Conclusions

The results showed that Cu²⁺ and Zn²⁺ were efficiently removed from model solution using powdered form of zeolite A. The removal of Zn²⁺ increased with increased pH value using granular zeolite, however the results using powdered zeolite A were better. The removal of Cu²⁺ was in all experiments below 0.1 mg/L. It did not depend neither on pH value nor of the type of zeolite. The appropriate concentration in model solutions was 2 g per 10 mg of Cu²⁺ or Zn²⁺ in model sample.

Zaštita okoliša / Environmental Protection

When treating real compost leachate samples, 2 g of zeolite did not remove Zn^{2+} nor Cu^{2+} ions. The best result was achieved with the amount of zeolite 4 g per 100 mL of sample, 1 g of activated carbon, following with the adjustment at pH=10 by lime only. The removal efficiency was calculated at 80.4 %, the concentration decreased to 0.53 mg/L Zn^{2+} . The concentration decreased from 0.23 mg/l to 0.08 mg/L Cu^{2+} with the same procedure.

It could be concluded that metals could be removed from compost leachate by using zeolite. However, the organic material, had enormous impact on metal removal.

References

- Babel, S., Kurniawan, T. (2003): Low-cost adsorbents for heavy metals uptake from contaminated water: a review, *J. Hazard. Mater.*, B97, 219–243.
- CNSI, Water purification, High school nanoscience program, UCLA, 2016
- Delkash, M., Bakhshayesh, B. E., Kazemian, H. (2015): Using zeolitic adsorbents to clean up special wastewater streams: A review. *Micropor. Mesopor. Mat.*, 214, 224-241.
- Fu, F. and Wang, Q. (2011): Removal of heavy metal ions from wastewater: A review. *J. Environ. Manage.*, 92, 407-418.
- MSDS, Material safety data sheet, Asorbio, CNSI, High school nanoscience programme, 2016.
- Malamis, S. and Katsou, E. (2013): A review on zinc and nickel adsorption on natural and a modified zeolite, bentonite and vermiculite: Examination of process parameters, kinetics and isotherms, *J. Hazard. Mater.*, 252-253, 428-461.
- Official Gazette of Republic of Slovenia, 62/2008.(2008): Decree of material emission at leachate release from waste landfill, Government of Republic of Slovenia.
- Tabatabaei, S. T., Najafi, P., Mirzaei, S. M. J., Nazem, Z., Heidarpour, M., Hajrasoliha, S., Afyuni, M., Harchegani, H. B., Landi, E., Akasheh, L., Zamanian, M., Barani, M., Amini, H (2012): Compost leachate recycling through land treatment and application of natural Zeolite. *Int. J. Recycl. Org. Waste Agric.* 1:2 DOI: 10.1186/2251-7715-1-2.

Izvorni znanstveni rad

Kinetika biosorpcije u obradi farmaceutskih otpadnih voda

Monika Šabić^{1*}, Petra Vukić¹, Marija Vuković Domanovac¹, Ernest Meštrović²

¹Sveučilište u Zagrebu, Fakultet kemijskog inženjerstva i tehnologije,

Zavod za industrijsku ekologiju, Marulićev trg 19, 10000 Zagreb, Hrvatska

²PLIVA Hrvatska d.o.o., Prilaz baruna Filipovića 25, 10000 Zagreb, Hrvatska

*Dopisni autor: msabic@fkit.hr

Sažetak

Biološka obrada otpadnih voda pomoću aktivnog mulja je često upotrebljavan proces zbog ekonomskih i ekoloških razloga. Biosorpcija je fizikalno-kemijski proces vezanja onečišćujućih tvari iz otpadne vode na stanične strukture biološkog materijala. Farmaceutske otpadne vode mogu sadržavati onečišćenja u obliku polaznih sirovina, organskih otapala, međuprodukata te aktivnih farmaceutskih spojeva. U ovom radu istraženo je potencijal aktivnog mulja u uklanjanju organskih onečišćujućih tvari iz farmaceutske otpadne vode pomoću procesa biosorpcije. Pokusi su provedeni u šaržnim uvjetima pri različitim početnim koncentracijama aktivnog mulja od 3,36 do 7,98 g/dm³ te početnoj koncentraciji farmaceutske otpadne vode $\gamma_{s0} = 1589,9 \pm 161,3$ mg/dm³. Procesom biosorpcije uklonjeno je između 40,1 i 60,3 % toksičnih tvari, dok je učinkovitost uklanjanja organskih tvari iznosila do 14,6 %. Dobiveni rezultati opisani su Freundlichovim modelom, pri čemu je R² iznosio 0,931, dok su vrijednosti Freundlichovih konstanti, K_f i n, iznosile 4,77 dm³/g i 0,17.

Ključne riječi: biosorpcija, farmaceutska otpadna voda, aktivni mulj

Uvod

Ubrzan ekonomski i tehnološki razvoj te poboljšani životni uvjeti produžili su životni vijek čovjeka. Samim time, povećala se potražnja lijekova za upotrebu u kućanstvu i bolnicama, što je dovelo i do razvoja farmaceutske industrije. Proizvodnja farmaceutika stvara otpadne tokove različitog sastava koji ovisi polaznoj sirovini, tehnološkim procesima i otpadnim produktima. Otpadne vode farmaceutske industrije najčešće nastaju u procesima sinteze i formulacije (Gadipelly i sur., 2014) i sadrže specifična onečišćenja kao što su neizreagirani reaktanti, organska otapala, katalizatori, aditivi, međuprodukti te ostaci pomoćnih tvari i aktivnih farmaceutskih tvari (Deegan i sur., 2011). Poznavanje tvari uključenih u proces rezultira poznatim sastavom otpadne vode, što omogućava ciljanu obradu (Lefebre i sur., 2014; Šabić i sur., 2015.). Biološka obrada otpadnih voda je učinkovita te ekološki i ekonomski prihvatljiv postupak, pri čemu se sama obrada zasniva na korištenju aktivnog mulja u svrhu uklanjanja onečišćujućih tvari. Aktivni mulj je mješovita zajednica mikroorganizama, koji se najvećim udjelom sastoji od bakterija, zatim protozoa i metazoa (Cordi i sur., 2012).

Zaštita okoliša / Environmental Protection

Mikroorganizmi se povezuje u pahuljice aktivnog mulja te o njihovoj kakvoći ovisi učinkovitost obrade otpadne vode (Mesquita i sur., 2013). Obrada otpadne vode pomoću aktivnog mulja sastoji se od procesa biosorpcije te biorazgradnje organske tvari. Biosorpcija je fizikalno-kemijski proces u kojem dolazi do vezanja onečišćujućih tvari iz otpadne vode na staničnu strukturu biomase (Fomina i sur., 2014; Zhang i sur., 2014). Biosorpcijski potencijal aktivnog mulja prikazuje se kao biosorpcijski kapacitet o uvjetima rada odnosno o temperaturi, pH-vrijednosti te koncentraciji sorbata i sorbenta, pri čemu maksimalni sorpcijski kapacitet određuje najpovoljniji sorbens (Chojnacka i sur., 2010). Ravnotežni kapacitet biosorpcije aktivnog mulja q_e (mg/g) prikazan je jednadžbom 1. (Zhang i sur., 2014):

$$q_e = \frac{\gamma_{s0} - \gamma_{se}}{\gamma_x} \quad (1)$$

gdje γ_{s0} prikazuje početnu koncentraciju supstrata (mg/dm^3), γ_{se} ravnotežnu koncentraciju supstrata (mg/dm^3), a γ_x koncentraciju aktivnog mulja (mg/dm^3). Sorpcija spojeva na čvrstu površinu i ravnotežna koncentracija u vodenom mediju može se opisati Freundlichovom izotermom prema empirijskom izrazu danom u jednadžbi 2., gdje je K_f Freundlichov biosorpcijski koeficijent (dm^3/g) te n , Freundlichova konstanta biosorpcije. Freundlichovom izotermom može se opisati proces sorpcije u višekomponentnim otopinama kao što su otpadne vode (Aksu, 2001; Yang i sur., 2011).

U ovom radu istražen je biosorpcijski potencijal aktivnog mulja u fazi endogene respiracije u svrhu uklanjanja organskih onečišćujućih tvari iz farmaceutske otpadne vode. Rezultati su opisani su Freundlichovim modelom.

$$q_e = K_f \cdot \gamma_{se}^{1/n} \quad (2)$$

Materijali i metode

Aktivni mulj i farmaceutska otpadna voda, koji su korišteni u pokusima biosorpcije, dopremljeni su iz Uredaja za obradu otpadnih voda s lokacije Savski Marof, Pliva Hrvatska d.o.o. Priređena početna koncentracija aktivnog mulja, izražena je preko vrijednosti suspendirane tvari odnosno koncentracije aktivnog mulja (γ_x). Koncentracija supstrata, γ_s , koja predstavlja ukupno onečišćenje otpadne vode iz farmaceutske industrije, izražena je preko vrijednosti kemijske potrošnje kisika. Faza endogene respiracije je postignuta aeriranjem aktivnog mulja tijekom 24 sata. Nakon 24 sata aeracija je zaustavljena, aktivni mulj je ugušćen taloženjem tijekom 3 sata i odekantiran je supernatant. Provedeni su pokusi biosorpcije u šaržnim uvjetima s početnom koncentracijom otpadne vode $\gamma_{s0} = 1589,9 \pm 161,3 \text{ mg}/\text{dm}^3$. Početne koncentracije aktivnog mulja u fazi endogene respiracije za navedene pokuse iznosile su $\gamma_{x01} = 3,36 \text{ g}/\text{dm}^3$, $\gamma_{x02} = 3,90 \text{ g}/\text{dm}^3$, $\gamma_{x03} = 4,94 \text{ g}/\text{dm}^3$, $\gamma_{x04} = 6,06 \text{ g}/\text{dm}^3$ te $\gamma_{x05} = 7,98 \text{ g}/\text{dm}^3$, označene kao X1-X5. Pokusi biosorpcije provedeni su u Erlenmeyerovim tikvicama od $1,0 \text{ dm}^3$ na rotacijskoj tresilici s brzinom vrtnje 160 min^{-1} , pri temperaturi $23 \text{ }^\circ\text{C}$, 30 minuta. Erlenmeyerove tikvice su sadržavale po 500 cm^3 suspenzije aktivnog mulja u fazi endogene respiracije početnih koncentracija od γ_{x01} do γ_{x05} i farmaceutsku otpadnu vodu početne koncentracije, γ_{s0} . Tijekom pokusa u uzorcima su određivane koncentracije supstrata i aktivnog mulja (APHA, 2012), toksičnost pomoću bioluminiscentne bakterije *Vibrio fischeri* (Günesf i sur., 2008) te je provedena mikroskopska analiza.

Rezultati i rasprava

Biosorpcijski potencijal prikazuje se kao biosorpcijski kapacitet koji je ovisan o uvjetima rada, koncentracijama sorbata i sorbensa te o temperaturi i pH-vrijednosti. Iz rezultata procesa biosorpcije farmaceutske otpadne vode s aktivnim muljem u endogenoj fazi prikazanih u Tablici 1. vidljivo je kako se povećanjem početnih koncentracija aktivnog mulja od X1 do X5 smanjuju vrijednosti ravnotežne koncentracije supstrata. Povećanjem koncentracije aktivnog mulja povećava se specifična površina mulja što omogućava i veću sorpciju supstrata. Vrijednost q_e povećava se sa smanjenjem početnih koncentracija aktivnog mulja, a predstavlja funkciju koncentracije mulja odnosno ravnotežni sorpcijski kapacitet koji je u linearnoj korelaciji s opterećenjem mulja (Zhang i sur., 2014). Povećanjem koncentracije aktivnog mulja vrijednosti q_e se smanjuju jer se smanjuje i količina sorbirane tvari po jedinici mase sorbensa. Odnosno, povećava se specifična površina sorbensa koja nije u potpunosti iskorištena što uzrokuje smanjenje ravnotežnog kapaciteta biosorpcije (Rajamohan, 2016). Koeficijent iskorištenja, Y , predstavlja koncentraciju biomase po jedinici uklonjenog supstrata te se računa prema jednadžbi 3. iz eksperimentalnih podataka (Vuković i sur., 2012):

$$Y = \frac{\gamma_{Xi} - \gamma_{X0}}{\gamma_{S0} - \gamma_{Si}} \quad (3)$$

U Tablici 1. vidljivo je smanjenje vrijednosti koeficijenta iskorištenja u odnosu na X1-X5. Budući da se proces sorpcije temelji na koncentriranju tvari iz otopine na površini sorbensa, aktivna površina je jedan od glavnih čimbenika koji utječu na sorpcijski kapacitet sorbensa. Općenito je sorpcijski kapacitet sorbensa proporcionalan njihovoj specifičnoj površini što znači da sorpcija tvari raste s povećanjem površine (Chojnacka, 2010; Yang i sur. 2011).

Tablica 1. Rezultati procesa biosorpcije farmaceutske otpadne vode s aktivnim muljem u endogenoj fazi

Table 1. Results of biosorption process of pharmaceutical wastewater treatment with activated sludge in endogenous respiration phase

Pokus	γ_{X0} , g/dm ³	γ_{Se} , mg/dm ³	q_e , mg/g	Y , g/g
X1	3,36	1619,0	67,56	0,55
X2	3,90	1547,7	62,14	0,46
X3	4,94	1441,0	49,73	0,34
X4	6,06	1387,3	34,93	0,26
X5	7,98	1254,7	15,46	0,17

Promjene ravnotežnog kapaciteta biosorpcije u ovisnosti o koeficijentu iskorištenja za X1-X5 koje su opisane polinomom drugog stupnja prikazane su Slikom 1. Smanjenjem koncentracije biomase povećava se vrijednost q_e . Iz jednadžbe polinoma drugog stupnja $y = -10,508x^2 + 134,42x$ dobiva se vrijednost za brzinu biosorpcije koja iznosi $k=268,8$ mg/g h uz zadovoljavajuću vrijednost R^2 od 0,945.

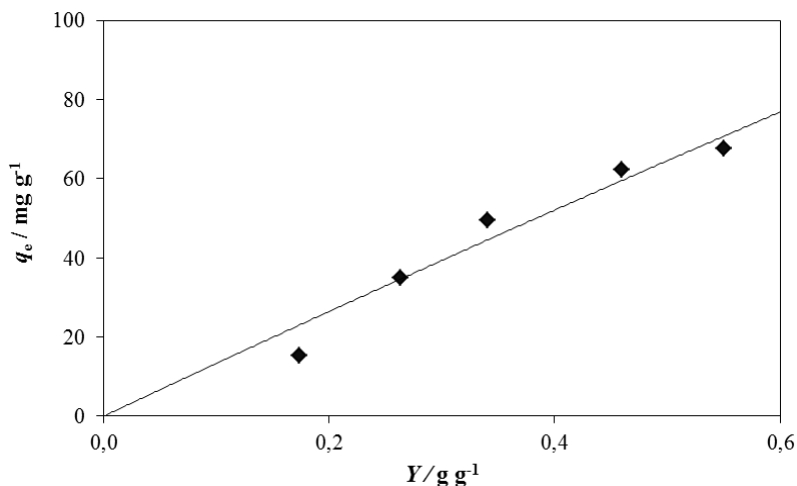

Slika 1. Promjene ravnotežnog kapaciteta biosorpcije i koeficijenta iskorištenja za X1-X5
Fig. 1. Changes in equilibrium adsorption capacity and yield coefficient for X1-X5

Logaritamski oblik Freundlichove izoterme (jednadžba 2.) u procesu biosorpcije prikazan je Slikom 2. Iz dobivene jednadžbe pravca izračunate su Freundlichove konstante $K_f = 4,77 \text{ dm}^3/\text{g}$ i $n = 0,17$. Dobivena visoka vrijednost R^2 od 0,931 ukazuje da se proces biosorpcije može se opisati Freundlichovim modelom. Farmaceutske otpadne vode sadrže različite skupine spojeva koji utječu na učinkovitost biosorpcije (Hamon i sur., 2014), pri čemu se učinkovitost navedenog procesa računa prema jednadžbi 4.

$$\% = \frac{\gamma_{s0} - \gamma_{se}}{\gamma_{s0}} \times 100 \quad (4)$$

Učinkovitosti procesa biosorpcije u ovisnosti o početnim koncentracijama aktivnog mulja X1-X5 prikazana je na Slici 3. Iz grafičkog prikaza je vidljivo kako je najveći postotak učinkovitosti postignut pri početnoj koncentraciji aktivnog mulja γ_{x03} te je prosječna vrijednost učinkovitosti biosorpcije iznosila $12,5 \pm 2,2$ % za X1-X5. Učinkovitost uklanjanja farmaceutika kretala se od 9,0 do 14,6 % što odgovara rasponu uklanjanja farmaceutika 6,5-20,0 % (Yang i sur., 2010). Toksične tvari mogu utjecati na biološku aktivnost sustava za obradu (Deegan i sur., 2011). Slika 4. prikazuje promjenu utjecaja toksičnosti farmaceutskih otpadnih voda i koeficijenta iskorištenja u ravnotežnim uvjetima za X1-X5. Na početku pokusa, vrijednosti indeksa utjecaja toksičnosti, III_e , kretale su se između 17,9 i 25,4 za X1-X5, dok su se na kraju pokusa kretale od 9,1 do 13,7 što prema definiranoj skali (Günesf i sur., 2008) ukazuje da su farmaceutske otpadne vode toksične i vrlo toksične ovisno o X1-X5. Do kraja pokusa, toksičnost se smanjila u prosjeku na $11,6 \pm 1,8$. Povećanjem početnih koncentracija aktivnog mulja povećava se postotak uklonjenih toksičnih tvari iz farmaceutske otpadne vode (slika 5.) koji se kretao od 40,1 do 60,3 %, odnosno toksičnost je niža u području viših početnih koncentracija aktivnog mulja.

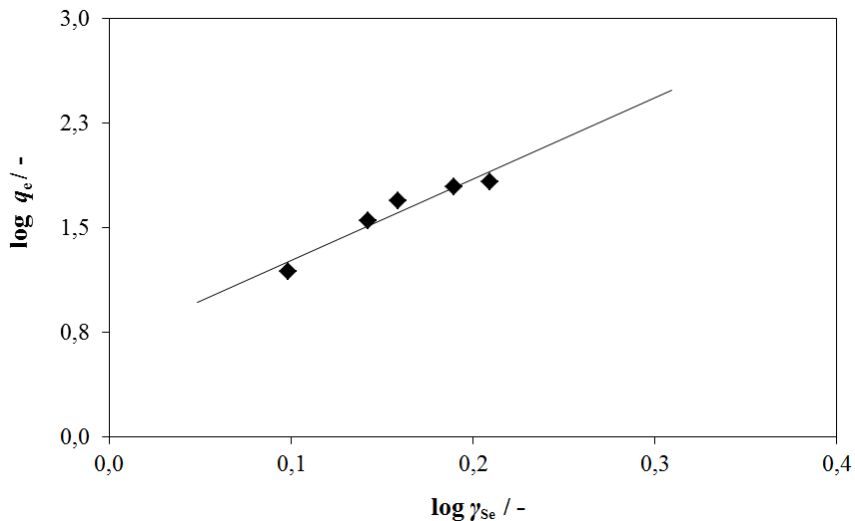

Slika 2. Logaritamski oblik Freundlichove izoterme u procesu biosorpcije
Fig. 2. Logarithmic form of Freundlich isotherm in biosorption process

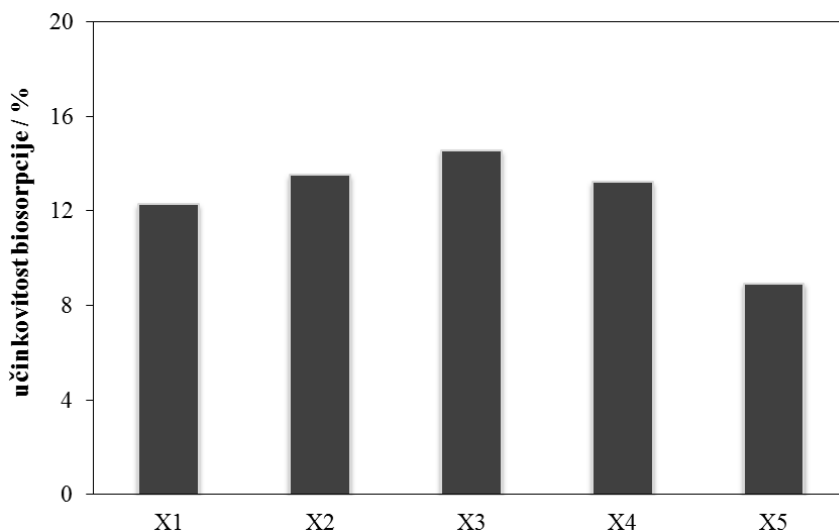

Slika 3. Učinkovitost procesa biosorpcije za početne koncentracije aktivnog mulja X1-X5
Fig. 3. Biosorption efficiency for initial concentrations of activated sludge X1-X5

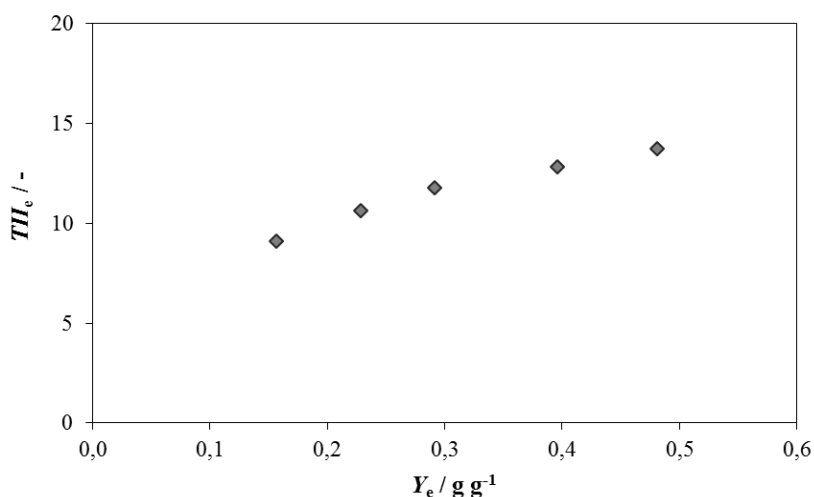

Slika 4. Promjena toksičnosti farmaceutskih otpadnih voda i koeficijenta iskorištenja u ravnotežnim uvjetima za X1-X5

Fig. 4. Changes in pharmaceutical wastewater toxicity and yield coefficient in equilibrium for X1-X5

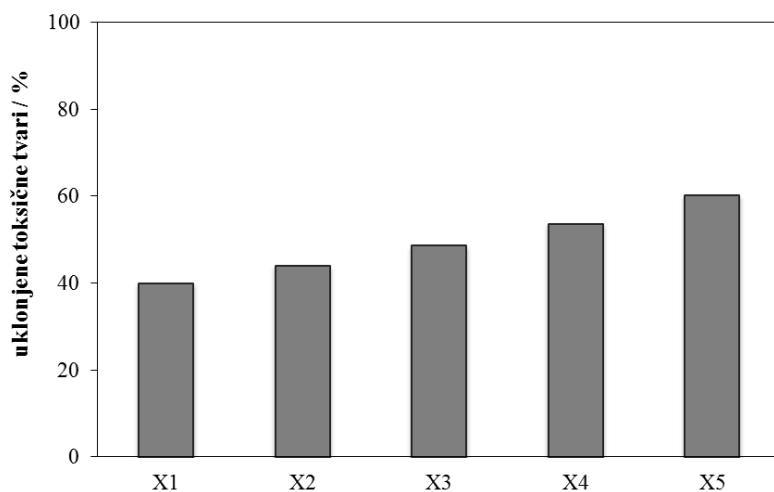

Slika 5. Učinkovitost uklonjenih toksičnih tvari iz farmaceutske otpadne vode u odnosu na početne koncentracije aktivnog mulja X1-X5

Fig. 5. Removal efficiency of toxic substances from pharmaceutical wastewater in relation to initial concentrations of activated sludge X1-X5

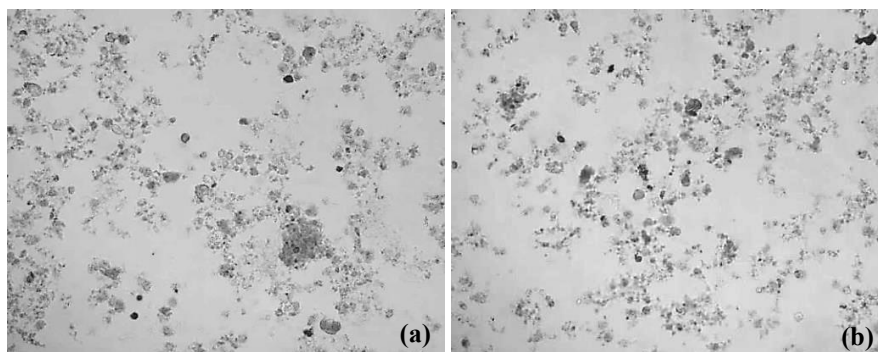

Slika 6. Mikrofotografije aktivnog mulja na početku (a) i na kraju (b) procesa biosorpcije za X4, P = 100×

Fig. 6. Microphotographs of activated sludge at the beginning (a) and the end (b) of biosorption process for X4, M=100×

Mikroskopskom analizom određivane su morfološke karakteristike uzoraka suspenzije aktivnog mulja. Slika 6. prikazuje mikrofotografije aktivnog mulja na početku i na kraju procesa biosorpcije farmaceutске otpadne vode za početnu koncentraciju aktivnog mulja γ_{X04} . Na kraju pokusa pahuljice aktivnog mulja su homogenije raspršene kako je prikazano na slici 6.b., na što su utjecali uvjeti miješanja. U procesu biosorpcije nije došlo do promjene u morfologiji pahuljica aktivnog mulja (Bitton, 2011).

Zaključci

Povećanjem početnih koncentracija aktivnog mulja povećava se njegova specifična površina što omogućuje veću sorpciju supstrata. Najveća učinkovitost procesa biosorpcije tijekom 30 minuta postignuta je za početnu koncentraciju aktivnog mulja $4,94 \text{ g/dm}^3$ i iznosila je 14,6 %. Pri višim koncentracijama aktivnog mulja postotak uklonjenih toksičnih tvari iznosio je do 60,3 %. Proces biosorpcije se može opisati Freundlichovim modelom na što ukazuje visoka vrijednost R^2 koja je iznosila 0,931, uz dobivene vrijednosti konstanti, K_f i n , koje su iznosile $4,77 \text{ dm}^3/\text{g}$ i 0,17. Aktivni mulj pokazuje biosorpcijski potencijal u obradi farmaceutskih otpadnih voda što može značajno doprinijeti zaštiti okoliša u cilju zbrinjavanja farmaceutskih otpadnih tokova.

Literatura

- Aksu, Z. (2001): Biosorption of reactive dyes by dried activated sludge: equilibrium and kinetic modelling, *Biochem. Eng. J.* 7, 79–84.
- APHA (2012): Standard Methods For the Examination of Water and Wastewater, 22th Edition, Washington.
- Bitton, G. (2011): Wastewater microbiology, New Jersey, John Wiley & Sons.
- Chojnacka, K. (2010): Biosorption and bioaccumulation the prospects for practical applications, *Environ. Int.* 36, 299-307.

Zaštita okoliša / Environmental Protection

- Cordi, L., Assalin, M.R., Ponezi, A.N., Duran, N. (2012): Identification of microbiota for activated sludge acclimated by paper mill effluent kraft E₁ bioremediation, *J. Biorem. Biodegrad.* 3 (11), 169.
- Deegan, A.M., Shaik, B., Nolan, K., Urell, K., Oelgemöller, M., Tobin, J., Morrissey, A. (2011): Treatment options for wastewater effluents from pharmaceutical companies, *Int. J. Environ. Sci. and Technol.* 8, 649-666.
- Fomina, M., Gadd, G.M. (2014): Biosorption: current perspectives on concept, definition and application, *Bioresour. Technol.* 160, 3-14.
- Gadipelly, C., Pérez-González, A., Ganapati, D.Y., Inmaculada, O., Ibáñez, R., Rathod, V.K., Kumudini, V.M. (2014): Pharmaceutical industry wastewater: Review of the technologies for water treatment and reuse, *Ind. Eng. Chem. Res.* 53, 11571-11592.
- Günesf, E.H., Günesf, Y., Talenie, I. (2008): Toxicity evaluation of industrial and land sources in a river basin, *Desalin.* 226, 348-356.
- Hamon, P., Villain, M., Marrot, B. (2014): Determination of sorption properties of micropollutants: What is the most suitable activated sludge inhibition technique to preserve the biomass structure, *Chem. Eng. J.* 242, 260-268.
- Lefebvre, O., Shi, X., Wu, C.H., Ng, H.Y. (2014): Biological treatment of pharmaceutical wastewater from the antibiotics industry, *Water Sci. Technol.* 69 (4) 855-861.
- Mesquita, D.P., Amaral, A.L., Ferreira, E.C. (2013): Activated sludge characterization through microscopy: A review on quantitative image analysis and chemometric techniques, *Anal. Chim. Acta* 802, 14-28.
- Rajamohan, N., Al-saadi, A., Ramachandran, K.P. (2016): Treatment of refinery waste water using modified sludge—Effect of process parameters, sorbent characterization and kinetic studies, *Desalin. Water Treat.* 57, 19741-19749.
- Šabić, M., Vuković Domanovac, M., Findrik Blažević, Z., Meštrović, E. (2015): Kinetika bioremedijacije farmaceutske industrijske otpadne vode, *Kem. Ind.* 64 (5-6) 229-236.
- Vuković, M., Ćosić, I., Kučić, D., Kopčić, N., Briški, F. (2012): Biodegradation kinetics of tobacco-waste leachate by activated sludge in a sequencing Batch Reactor (SBR), *Chem. Biochem. Eng. Q.* 26 (3), 191-198.
- Yang, S.F., Lin, C.F., Lin, A.Y.C., Hong, P.K.A. (2011): Sorption and biodegradation of sulfonamide antibiotics by activated sludge: Experimental assessment using batch data obtained under aerobic conditions, *Water Res.* 45, 3389-3387.
- Zhang, X., Li, X., Zhang, Q., Peng, Q., Zhang, W., Gao, F., (2014): New insight into the biological treatment by activated sludge: The role of adsorption process, *Bioresour. Technol.* 153, 160-164.

Original research paper

Biosorption kinetics in pharmaceutical wastewater treatment

Monika Šabić^{1*}, Petra Vukić¹, Marija Vuković Domanovac¹, Ernest Meštrović²

¹University of Zagreb, Faculty of Chemical Engineering and Technology,
Department of Industrial Ecology, Marulićev trg 19, 10000 Zagreb, Croatia

²PLIVA Hrvatska d.o.o., Prilaz baruna Filipovića 25, 10000 Zagreb, Croatia

*Corresponding author: msabic@fkit.hr

Summary

Biological process with activated sludge is commonly used process for wastewater treatment because of environmental and economic reasons. Biosorption is physiochemical process of binding contaminants from wastewater onto the surface of the cell structure of biological material. Wastewater from pharmaceutical industry may contain contaminants such as raw materials, organic solvents, intermediates and active pharmaceutical ingredients. Biosorbents in biological wastewater treatment is activated sludge, which is composed of different types of microorganisms, mainly bacteria aggregated in flocs.

In this study the role of activated sludge in the removal of organic contaminants from pharmaceutical wastewater with biosorption was investigated. Experiments were conducted in batch conditions at different initial concentrations of activated sludge from 3.36 to 7.98 g/dm³, and initial concentration of pharmaceutical wastewater $\gamma_{SO} = 1589.9 \pm 161.3$ mg/dm³. Removal efficiency of toxic compounds ranged between 40.1 and 60.3 %, while the highest efficiency of removed organic contaminants was 14.6 %. Obtained results were described with Freundlich model, where R^2 was 0.931, and values of Freundlich constants, K_f and n , were 4.77 dm³/g i 0.17, respectively.

Keywords: biosorption, pharmaceutical wastewater, activated sludge

Professional work

Monitoring of physical and chemical water quality parameters in the Danube – Drava rivers flood area

Nada Pitinac^{1*}, Marija Dundović¹, Đurđevka Pecikozić², Bruno Zelić³

¹*Technical School and Natural Sciences Gymnasium Ruđer Bošković,
Vukovarska cesta 209, 31 000 Osijek, Croatia*

²*Technical School Nikola Tesla, Blage Zadre 4, 32 010 Vukovar, Croatia*

³*University of Zagreb, Faculty of Chemical Engineering and Technology,
Marulićev trg 19, 10 000 Zagreb, Croatia*

**Corresponding author: nada.pitinac@skole.hr*

Summary

Water protection and water management are key factors in preserving the balance of natural ecosystems and water resources. Common causes of water pollution are economical activities of general population, wastewaters, precipitation runoffs from agricultural lands and erosion of polluted soil. Marshes and swamps slow down the passage of water and enable sedimentation of particles in the water. By cleaning surface waters there are no pollutants to influence ground waters. The aim of this paper was monitoring and comparison of physical – chemical parameters of water quality of flood area Danube – Drava for a time period December 2015 – March 2016 in order to assess the state of the ecosystem. Water monitoring was conducted using electrochemical and spectrophotometric methods in five locations: river Drava in Osijek, river Danube in Batina, Aljmaš and Vukovar and Sakadaš lake in natural park Kopački rit. Following conclusions raised out after analysis of experimental results. Changes in pH value are connected to the seasonal changes of water levels. Lake Sakadaš and river Danube in Batina have significantly higher levels of conductivity which are declining in the period of research and it can be connected to the rain season and flooding of the area of Kopački rit. Dissolved oxygen concentration values are much higher in lake Sakadaš than in other analyzed locations that could be result of a greater biological activity. Concentration of ammonium ions is higher at the beginning of the research period which can be attributed to runoffs of ammonia from the soil, autumnal agricultural activities and short time period necessary for oxidation. Rise in concentration of nitrates during February in lake Sakadaš could be caused by rising levels of ground water and flooding of Kopački rit with Danube water. Concentration of phosphorus is declining on all locations which could be linked to minor agricultural activity in analysed time period.

Keywords: water quality parameters, nutrients, water management

Introduction

Water protection and water management are most important factors in preserving the balance of natural ecosystems and water resources. Common causes of water pollution are human activities like municipal wastewaters, precipitation runoffs from agricultural lands and erosion of polluted

soil. Republic of Croatia belongs to water rich countries that are a part of Adriatic and Black sea basin which have a defined cooperation in water management. The Danube basin, as a part of Black sea basin, comprises of 18 European countries including the eastern part of Croatia. Kopački rit is a marsh area located in the eastern Croatian region of Slavonia and Baranja. It belongs to river Drava and river Danube basin and is on Ramsar list of important water habitats (Benčina et al., 2010). Rivers Drava and Danube, underground waters, precipitation, water vapor condensation and water from old Drava course influence the hydrology regimes of Kopački rit. Kopački rit is located in the middle part of Danube flow and is through natural canal network directly linked to Danube river which is the reason that Danube has the greatest influence on hydrological regimes of Kopački rit (Vidaković et al., 2011). When Danube water levels raise Kopački rit is flooded. Waters of river Drava influence flooding, but do not enter Kopački rit. Renovo channel is a direct link from Drava to Kopački rit but is primarily a way for water to drain from Kopački rit. Only high water levels does the water from Drava enter Kopački rit. Marsh areas, especially flood plains, slow water passage and allow sedimentation of particles and nutrients. Phosphorus and nitrogen compounds mainly from agricultural sources are precipitated by chemical and biological processes and used as food source for plant organisms. Plants and soils play an important role in water cleaning and removal of high concentrations of phosphorus and nitrogen, sometimes that also includes toxic compounds. This is of critical importance for downstream areas since it prevents eutrophication and keeps the water clean for drinking. Complex and ecologically very valuable system of Kopački rit is comprised of various aquatic and terrestrial habitats that is a home to many species (Mihaljević et al., 1999). In this paper to monitor the water quality the following physical – chemical parameters have been investigated: pH value, conductivity, dissolved oxygen concentration, nitrates, nitrites, ammonium and total phosphorus in order to assess ecological state of water in the flood area Drava - Danube (Figure 1.) in the time period from December 21st 2015 to March 4th 2016 in following locations: Drava – Osijek, Danube – Batina, Danube – Aljmaš, Danube – Vukovar, Sakadaš lake.

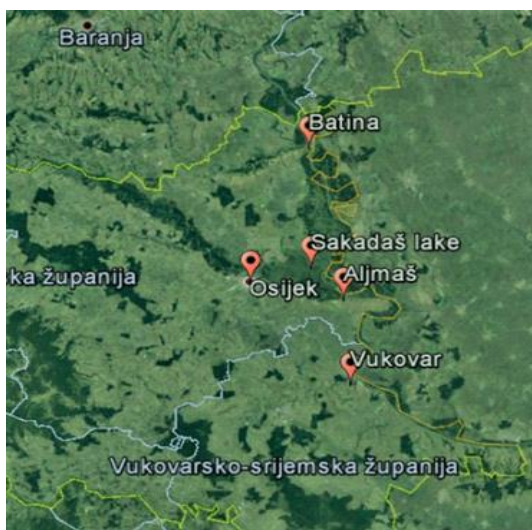

Fig. 1. Flood area Drava - Danube

Materials and Methods

Obtained samples of water from rivers Drava in Osijek and Danube in Batina, Aljmaš and Vukovar and water samples from lake Sakadaš have been analyzed.

Measurements of pH values, conductivity (κ) and dissolved oxygen have been conducted using HQ40d (Hach) portable meter and compatible probes: IntelliCAL digital probe for pH value, CDC401 – 01 probe for conductivity and LDO101 probe for dissolved oxygen concentration. All measurements have been conducted on site with the exception of samples from river Danube in Aljmaš which were analyzed the same day in laboratory. Samples were obtained manually using a 1 liter plastic bottle, according to Croatian normative documents for water sampling for human consumption, underground and surface waters (HRN ISO 5667-4:2000 Water quality-sampling-part 4: Guidelines for sampling natural and artificial lakes (ISO 5667-4:1987), HRN ISO 5667-6:2000 Water quality-sampling-part 6: Guidelines for sampling rivers and streams (ISO 5667-6:1990)).

Measurements of mass concentration (γ) of ammonium, nitrate and nitrite ions and concentration of total phosphorus have been conducted with DR3900 (Hach) spectrophotometer and ready cuvette tests. Measurement of total phosphorus was performed by sample digestion in an automatized high temperature thermostat HT 200 S (Hach) in the laboratory (Skoog et al., 1999; Rupčić-Petelinc and Weihnacht, 2005).

Results and Discussion

Water temperature affects movement of molecules, fluid dynamics, concentration of dissolved gases, metabolism rates of living organisms and other factors. The largest influence on surface waters temperature has solar radiation (Hauer and Hill, 2006). In addition, water temperature, conductivity and other physical-chemical parameters of water have a key influence on algal and invertebrate communities in aquatic ecosystems (Vidaković et al., 2012). Average air temperature value in eastern Slavonia and Baranja in December was 2.3 °C with little precipitation, in January the temperature was 2.0 °C and in February 5.4 °C with large amounts of precipitation. In the research period the water temperature always was above 0 °C (min. 1.6 °C, max. 11.2 °C). pH values of all samples were higher than 7.00 (exception is one sample of Danube in Batina). Most analyzed samples had pH values in the range of 7.80 – 8.70 with average value 8.17 (Figure 2.). Natural waters contain significant quantities of carbon dioxide and such waters are natural alkaline due to presence of hydrogen carbonate ion (Tuhtar, 1984.) and our results are in agreement with that statement. Also, in most natural waters concentration of hydrogen ions depends on the ratio of carbon dioxide and hydrogen carbonate ion and values of pH are between 4.5 and 8.3. pH values can be influenced by content of humic compounds, alkaline carbonates, hydroxides, inorganic salts that are susceptible to hydrolysis and aquatic plant consumption of carbon dioxide (Mihanović and Perina, 1982).

Conductivity differed depending on location. Conductivities of the river Drava were the lowest in comparison to other locations while conductivities of Danube in Aljmaš and Vukovar are a bit higher and had not changed significantly. Sakadaš lake and Danube in Batina measure the highest conductivities (Figure 3.). In shallow and unpolluted surface waters conductivity can be used as an indicator of inorganic salts content.

In industrial wastewaters occurrence of organic acids is possible which results in the higher water conductivity. In that case, conductivity is a good indicator of organic and inorganic electrolyte content (Mihanović and Perina, 1982) and thus we conclude that Danube in Batina and lake Sakadaš have higher electrolyte content.

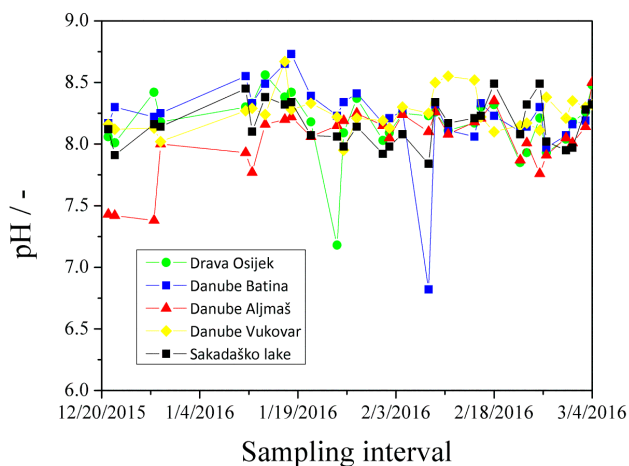

Fig. 2. pH-values in the Danube – Drava flood region in the time period December 21st 2015 – March 4th 2016

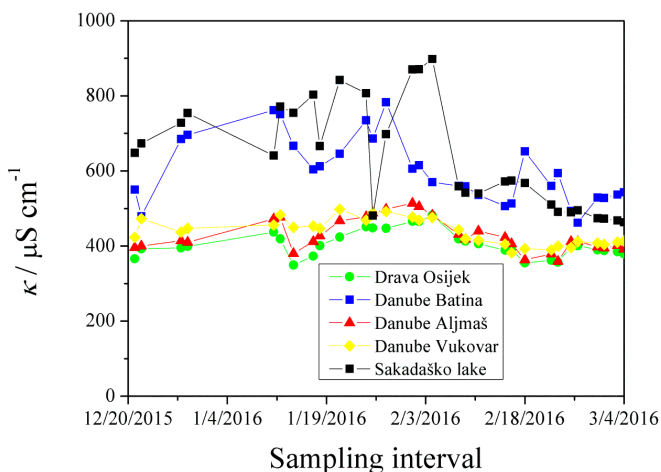

Fig. 3. Conductivity in the Danube – Drava flood region in the time period December 21st 2015 – March 4th 2016

Zaštita okoliša / Environmental Protection

Dissolved oxygen concentration has a direct effect on aquatic organisms as available oxygen and indirectly through various biogeochemical cycles. In most unpolluted river systems dissolved oxygen concentration will be present above 80% saturation (Hauer and Hill, 2006). Concentrations of dissolved oxygen corresponded to Drava and Danube water temperature and elevated air pressure. All measured concentrations of dissolved oxygen were greater than 100% oxygen saturation while the minimal measured concentration of dissolved oxygen was 9.29 mg dm^{-3} . On average value concentration of dissolved oxygen was much higher in Sakadaš lake (Figure 4.).

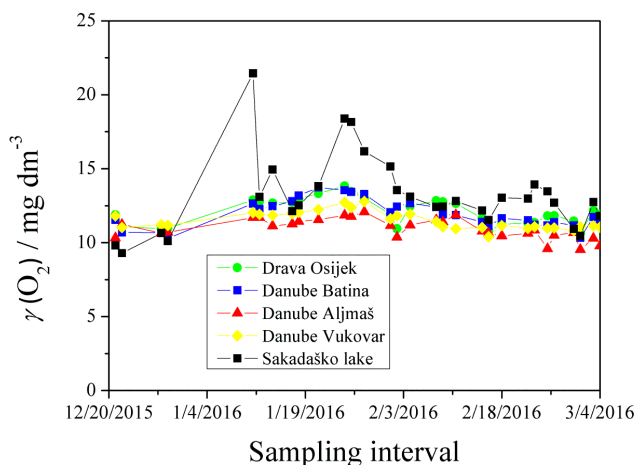

Fig. 4. Mass concentration of dissolved oxygen in the Danube – Drava flood region in the time period from December 21st 2015 – March 4th 2016

Antropogenic activities as burning of fossil fuels, nitrogen fixating crops, usage of mineral fertilizers and deposition of wastewaters have doubled the amount of nitrogen in global matter cycles. Dissolved inorganic nitrogen enters aquatic ecosystems as ammonium ion in wastewaters and as nitrate ion from agriculture activities (Tank et al., 2006). Ammonium ion concentrations ($\text{NH}_4^+\text{-N}$) were higher in December and January for all locations. This can be attributed to runoffs of ammonia from the soil, autumnal agricultural activities and short time period necessary for oxidation of nitrite ion. Later in the research period concentrations of ammonium ions were similar on all locations (Figure 5.).

Nitrites are an intermediate compound in biochemical oxidation of ammonium to nitrates. Their presence usually indicates a fecal matter pollution (Mihanović and Perina, 1982). Concentration of nitrites changed during the research period on all locations that could be linked to instability of nitrite ions and their easier oxidation to nitrates (Figure 5.).

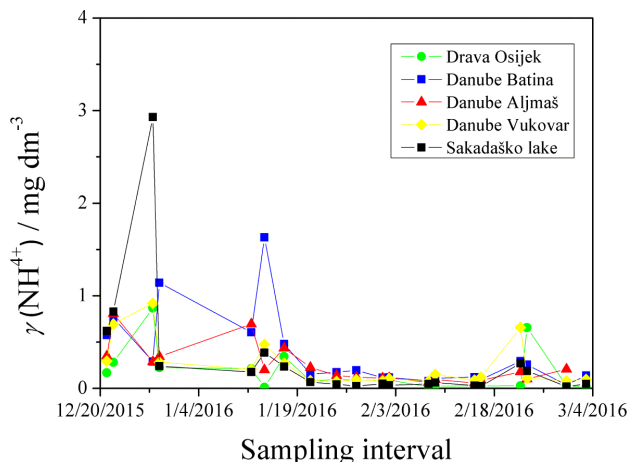

Fig. 5. Mass concentration of ammonium ions in the Danube – Drava flood region in the time period December 21st 2015 – March 4th 2016

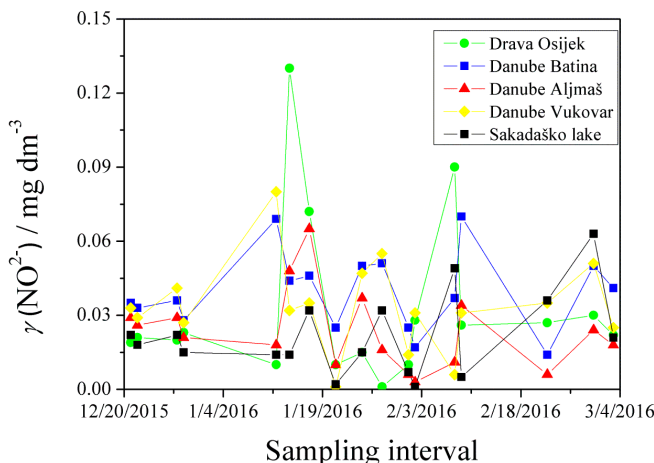

Fig. 6. Mass concentration of nitrite ions in the Danube – Drava flood region in the time period December 21st 2015 – March 4th 2016

Concentration of nitrates (NO_3^-) differs on all locations and is highest in Batina and lowest in Sakadaš lake. Concentration peaks occurred in February in Sakadaš lake and could be explained as a result of flooding with water from Danube and rising of ground waters caused by large amounts of precipitation (Figure 7.). Tank et al. (2006) conclude that retention of ammonium and nitrate ions in the ecosystem depends on biotic demand, type of sediment and physical characteristics of surrounding area.

Zaštita okoliša / Environmental Protection

Periphyton communities in swamps and lakes significantly contribute to removing of large quantities of nutrients since nutrients cause shift towards development of filamentous algae which are a base for periphyton (Azim et al., 2005). According to Steinman and Mulholland (2006) increased deposition of nutrients in waters has lead to impairments like eutrophication, increased sedimentation, algal blooms and increased amount of pollutants which are successfully removed by algal and periphyton communities. Limiting nutrient in primary production of aquatic ecosystems is phosphorus (Correll, 1999). High concentrations of total phosphorus (P) are detected during December in Danube and Sakadaš lake while low concentrations of total phosphorus are present during January and February in all locations. These results could be explained with absence of agricultural activity in these months (Figure 8.). Also, McDougal and Goldsborough (1994) comment on mechanism responsible for reduction of pollutants in aquatic systems by wetlands composed of degradation of phosphorus and other chemical species by the large populations of aerobic and anaerobic microorganisms.

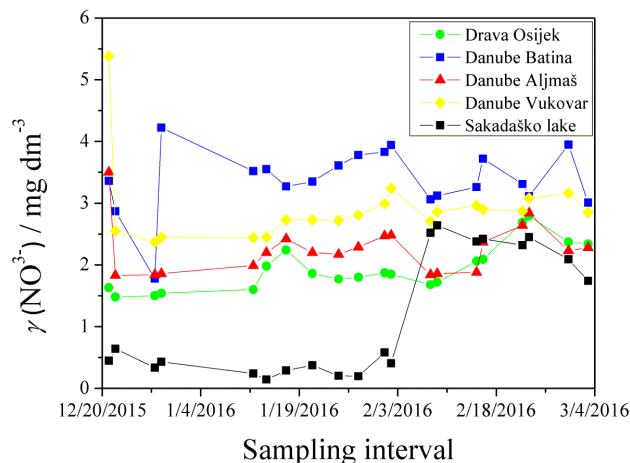

Fig. 7. Mass concentration of nitrate ions in the Danube – Drava flood region in the time period December 21st 2015 - March 4th 2016

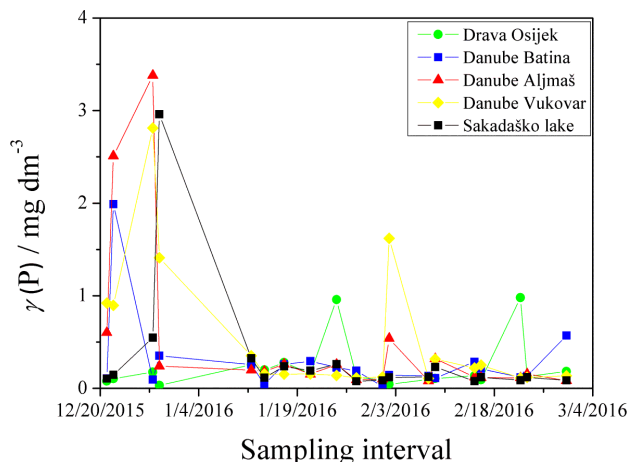

Fig. 8. Mass concentration of total phosphorus in the Danube – Drava flood region in the time period December 21st 2015 – March 4th 2016

Conclusions

Changes in pH values were linked to seasonal changes in water levels of Danube, Drava and Sakadaš lake. Higher amounts of precipitation during January and February and higher water levels of Danube are linked to conductivity decrease in Sakadaš lake and Danube in Batina. Dissolved oxygen concentrations were significantly higher in Sakadaš lake which is explained by higher biological activity (photosynthetic organisms). Lowering of ammonium ion concentrations and total phosphorus concentrations is a result of absent agricultural activity in the winter season. Concentrations of nitrite and nitrate ions differ on all locations and are a result of nitrite oxidation to nitrates and changes of water levels and ground water levels, respectively.

References

- Azim, M.E., Verdegem, M.C.J., van Dam, A.A., Beveridge, M.C.M. (2005): *Periphyton: Ecology, Exploitation and Management*, Wallingford, UK: CABI Publishing, pp. 352.
- Benčina, L., Rožac, V., Bolšec, B. (2010): *Plan upravljanja parkom prirode Kopački rit, Tikveš*, HR: Javna ustanova "Park prirode Kopački rit", pp. 17-26.
- Correll, D.L. (1999): Phosphorus: a rate limiting nutrient in surface waters, *Poultry Sci.* 78 (5), 674-682.
- Hauer, F.R., Hill, W.R. (2006): *Temperature, Light, and Oxygen*, In: *Methods in Stream Ecology*, Hauer, F.R., Lamberti, G.A., Cambridge, Massachusetts, USA: Academic Press, pp. 103-117.

Zaštita okoliša / Environmental Protection

- McDougal, R.L.L., Goldsborough, G. (1994): Responses of wetland algae and macrophytes to press and pulse additions of inorganic nitrogen and phosphorus, *UFS Annual Report*, 29 (140), 145-167.
- Mihaljević, M., Getz, D., Živanović, B., Gucunski, D., Topić, J., Kalinović, I., Mikuška, J., Hackenberger, D. (1999): Kopački rit: pregled istraživanja i bibliografija. Hrvatska akademija znanosti i umjetnosti, Zavod za znanstveni rad, Zagreb, HR, pp 188.
- Mihanović, B., Perina, I. (1982): Fizikalno i kemijsko ispitivanje zagađenosti vode, Zagreb, HR: Školska knjiga, pp 34-35, 54.
- Rupčić-Petelinc, S., Weihnacht, Z. (2005): Praktikum iz fizikalne kemije, Zagreb, HR: Školska knjiga, pp 22-36, 108-109.
- Skoog, D.A., West, D.M., Holler, F.J. (1999): Osnove analitičke kemije, Zagreb, HR: Školska knjiga, pp 383-415, 516-554.
- Steinman, A.D., Mulholland, P.J. (2006): Phosphorus Limitation, Uptake and Turnover in Benthic Stream Algae, In: *Methods in Stream Ecology*, Hauer, F.R., Lamberti, G.A., Cambridge, Massachusetts, USA: Academic Press, pp. 187-212.
- Tank, J.L., Bernot, M.J., Rosi-Marshall, E.J. (2006): Nitrogen Limitation and Uptake, In: *Methods in Stream Ecology*, Hauer, F.R., Lamberti, G.A., Cambridge, Massachusetts: Academic Press, pp. 213-228.
- Tuhtar, D. (1984): Zagađenje zraka i vode, Sarajevo, BiH: Svjetlost, pp 151.
- Vidaković, J., Turković – Čakalić, I., Stević, F., Čerba, D. (2012): The influence of different hydrological conditions on periphytic invertebrate communities in a Danubian floodplain, *Fundam. Appl. Limnol.* 181 (1), 59-72.

Original research paper

Antioxidative response of wheat genotypes under *Fusarium* spp. infestation

Tihana Marček^{1*}, Marija Viljevac Vuletić², Sara Alivojvodić¹,
Ivan Bakula¹, Valentina Španić²

¹Josip Juraj Strossmayer University of Osijek, Faculty of Food Technology Osijek,
Department of Food and Nutrition Research, F. Kuhača 20, 31000 Osijek, Croatia

²Agricultural Institute Osijek, Južno predgrađe 17, 31000 Osijek, Croatia

*Corresponding author: tihana.marcek@ptfos.hr

Summary

Fusarium head blight (FHB) caused by fungi *Fusarium* spp., is a serious wheat (*Triticum aestivum* L.) disease that can reduce yield and quality of the grain. Fungi produces mycotoxins that can be harmful to humans and animals. Plants provide ROS-scavenging mechanisms that include both antioxidative enzymatic and nonenzymatic systems. Enhanced activities of ROS antioxidative enzymes can be a great indicator of genotype susceptibility under pathogen infestation. The aim of this work was to investigate the effect of *Fusarium* spp. in three wheat genotypes ('Super Žitarka', 'Apache' and 'Lucija') through activity of antioxidative enzymes, level of lipid peroxidation, H₂O₂ concentration and protein content. At the anthesis, ears were inoculated by the suspension of *Fusarium* spp. and left under *in vivo* conditions. After 7 days of treatment in all wheat genotypes, *Fusarium* did not cause notable changes in catalase (CAT) activity. Treated ears of 'Super Žitarka' showed inhibition of APX activity. At the same time in 'Lucija' pathogen induced remarkably increase in activity of guaiacol peroxidase (POD) and polyphenol oxidase (PPO), decreased H₂O₂ concentration, decline in malonedialdehyde (MDA) content and lower protein content. The variances in antioxidative response and protein content imply genetic variability of wheat genotypes, which can cause differences in *Fusarium* spp. susceptibility.

Keywords: *Fusarium* spp., wheat genotypes, antioxidative enzymes, lipid peroxidation, hydrogen peroxide concentration

Introduction

In nature, plants are often exposed to a number of abiotic and biotic stress factors. The environmental stresses include a pathogen attack, insects, chemicals, drought, salinity, heat, cold, ozone and UVB-radiation (Mahajan and Tuteja, 2005). Among them, stress induced by filamentous fungi from the genus *Fusarium* is a biotic factor that cause a serious wheat (*Triticum aestivum* L.) disease known as *Fusarium* head blight (FHB). Frequent rainfall combined with moderate temperature, promote production and dispersal of spores by air flow. In wheat, FHB impedes plant development, especially development of ears. Infected ears show signs of bleaching while contaminated grains are often wrinkled with significantly reduced weight. *Fusarium graminearum*

Zaštita okoliša / Environmental Protection

Schwabe and *Fusarium culmorum* (W.G. Smith) Saccardo are considered to be most common pathogens in wheat (Walter et al., 2010). These species produce secondary metabolites in seeds, primarily a mycotoxin deoxynivalenol (DON), which are not suitable for consumption by both human and animals (Fung and Clark, 2004).

Under pathogen infestation, plants activate numerous specific mechanisms that partially restrict pathogen extracellular and intracellular growth and penetration of the hyphae. Such defence mechanisms include hypersensitive response (HR), also called plant cell death, recruitment of cell wall by disposition of building materials and expression of pathogenesis-related proteins (PRs) (Wang et al., 2005; Zhang et al., 2013). In the early stage of plant-pathogen interaction, plant produces excessive concentration of reactive oxygen species (ROS), like H₂O₂, superoxide (O₂^{•-}) and hydroxyl (OH[•]) radicals, highly reactive molecules, that can cause irreversible changes in the cell like unspecific oxidation of proteins and/or nucleic acids and membrane lipids degradation resulting in loss of physiological functions (Dat et al., 2000; Miller et al., 2009). *Fusarium* attack leads to DON production which contributes to disruption of the integrity of cell membranes, chloroplasts or ribosomes, inhibits synthesis of proteins and triggers the production of H₂O₂ (Bushnell et al., 2010; Diamond et al., 2013; Shifrin et al., 1999).

In order to cope with excessive ROS concentration in cell under stress conditions, plant activates scavenging antioxidative enzymatic and nonenzymatic systems. Non-specific peroxidase (POD), catalase (CAT) and ascorbate peroxidase (APX) are the most important antioxidative enzymes (Caverzan et al., 2016 a; Miller et al., 2009) while polyphenol oxidase (PPO) is involved in nonenzymatic detoxification of ROS by using flavonoids and phenolics as substrates (Boeckx et al., 2015; Mayer, 2006). Numerous studies emphasize that enhanced activities of ROS antioxidative enzymes could be a great indicator of genotype susceptibility under pathogen infestation (Madadkhah et al., 2012; Racchi, 2013; Shahbazi et al., 2010; Sorahinobar et al., 2015).

The aim of present study was to investigate the effect of *Fusarium* spp. on antioxidative response (APX, CAT and POD), lipid peroxidation content, H₂O₂ level and PPO activity in wheat genotypes ('Super Žitarka', 'Apache' and 'Lucija').

Materials and Methods

Field experiment and treatment

In the present study, three wheat genotypes were used: 'Super Žitarka', 'Apache' and 'Lucija'. Field plots were inoculated with mixture of *Fusarium graminearum* and *Fusarium culmorum* (first treatment), and the second treatment were control plots which were left to natural infection. Spray inoculations were performed in the field at flowering (Zadok's scale 65) (Zadoks et al., 1974) using a tractor back sprinkler. Inoculations were performed in the late afternoon and to maintain moisture on the ears, water was sprayed on several occasions during the day. Ears were sampled after 7 days of *Fusarium* inoculation in both treated and non-treated plots. Fresh tissue (250 mg) was homogenized in 50 mmol/dm³ potassium phosphate buffer (pH 7.0) by addition of 0.1 mmol/dm³ ethylenediaminetetraacetic acid, 5 mmol/dm³ ascorbate acid and polyvinylpyrrolidone, centrifuged at 14 000 ref for 30 min at 4 °C and supernatants were used for determination of total protein content (Bradford, 1976) and enzyme activity.

Antioxidative enzyme activity

POD activity was measured as peroxidation of hydrogen peroxide with guaiacol as an electron donor at 470 nm (Siegel and Galston, 1967). CAT activity was estimated by the decrease in absorbance at 240 nm (Aebi, 1984). APX activity was analysed by monitoring the decrease in absorbance of ascorbate at 290 nm (Nakano and Asada, 1981). PPO activity was determined as a rate of oxidation of pyrogallol by the increase in absorbance at 430 nm (Raymond et al., 1993) For all enzyme assays, activities were expressed as units (U) of enzyme activity per milligram of protein [$\mu\text{mol min/mg}_{\text{proteins}}$].

Extraction and estimation of malondialdehyde (MDA) and H₂O₂ concentration

In order to determine MDA content and H₂O₂ concentration, fresh material (400 mg) was homogenized using 0.1% (w/v) trichloroacetic acid (TCA) and centrifuged at 12 000 rcf for 15 min at 4°C. The content of MDA, the final product of lipid peroxidation, was measured according to Verma and Dubey (2003). 0.5 % TBA in 20% TCA was added to 0.5 ml of supernatant, incubated at 95 °C for 30 min and cooled in an ice bath. The samples were centrifuged (14 000 rcf for 15 min at 4°C) and the absorbance of the supernatant was read at 532 nm and corrected for non-specific turbidity by subtracting the absorbance at 600 nm. 0.5 % TBA in 20 % TCA solution was used as a blank. The MDA content was calculated using the molar extinction coefficient as 155 mmol/dm³/cm. H₂O₂ concentration was quantified according to Velikova et al. (2000). After addition of 0.5 ml of supernatant into 10 mmol/dm³ potassium phosphate buffer (pH 7.0) and 1 mol/dm³ KI, mixture was stored in darkness for 20 min. Absorbance of the mixture was read at 390 nm. H₂O₂ content was determined using a calibration curve obtained with H₂O₂ solutions ranging from 20 to 700 $\mu\text{mol/dm}^3$ and expressed as millimoles per gram of fresh weight [mmol/g_{FW}]. Each experiment was set up in two separate repetitions. All results were expressed as means of five replicates (\pm SE) and compared by post-hoc Tukey (HSD) test at P < 0.05 using Statistica 12 software.

Results and Discussion

Analysis of different wheat genotypes under the same treatment demonstrated that 'Lucija' to *Fusarium* stress responded by significant increase in POD and PPO activity compared to 'Super Žitarka' and 'Apache' indicating important role of enzymatic and nonenzymatic antioxidative system in ROS removal (Figs. 1a, 1b). Great involvement of POD and PPO in ROS depletion under fusarium wilt disease was observed in eggplant (*Solanum melongena* L.) (Altinok and Dikilitas, 2014). High POD activity in 'Lucija' under *Fusarium* infestation suggesting its enhanced involvement in lignification and suberinization of the cell wall during pathogen attack (Fig. 1a). Important role of POD in the straightening of the cell wall under stress caused by *Phytophthora capsici* Leonian was noticed in *Capsicum annum* (Alcazar et al., 1995). Increased PPO activity, an enzyme responsible for phenolic oxidation, in 'Lucija' under *Fusarium* treatment, suggests that nonenzymatic antioxidative system in this genotype participates in defence response against *Fusarium* stress (Fig. 1b). The same trend was observed in *Fusarium* resistant wheat cultivar 'Sumai3' (Sorahinobar et al., 2015) and rose (*Rosa centifolia* L.) plant infected by *Alternaria tenuis* (Fr.) Keissl. (Khatun et al., 2009).

Zaštita okoliša / Environmental Protection

'Super Žitarka' showed inhibition of APX after exposure to *Fusarium* stress suggesting that APX perhaps in this genotype is not involved in ROS detoxification (Fig. 1c). Reduced APX activity was also noticed in *Fusarium*-sensitive wheat cultivar 'Sumai3' (Sorahinobar et al., 2016). Activity of CAT did not show notable changes under *Fusarium* treatment, suggesting that CAT in observed wheat genotypes probably is not involved in defence response (Fig. 1d). From our results, it is evident that antioxidative response of 'Super Žitarka', 'Apache' and 'Lucija' under *Fusarium* spp. infestation, depends of genetic potential of the genotype.

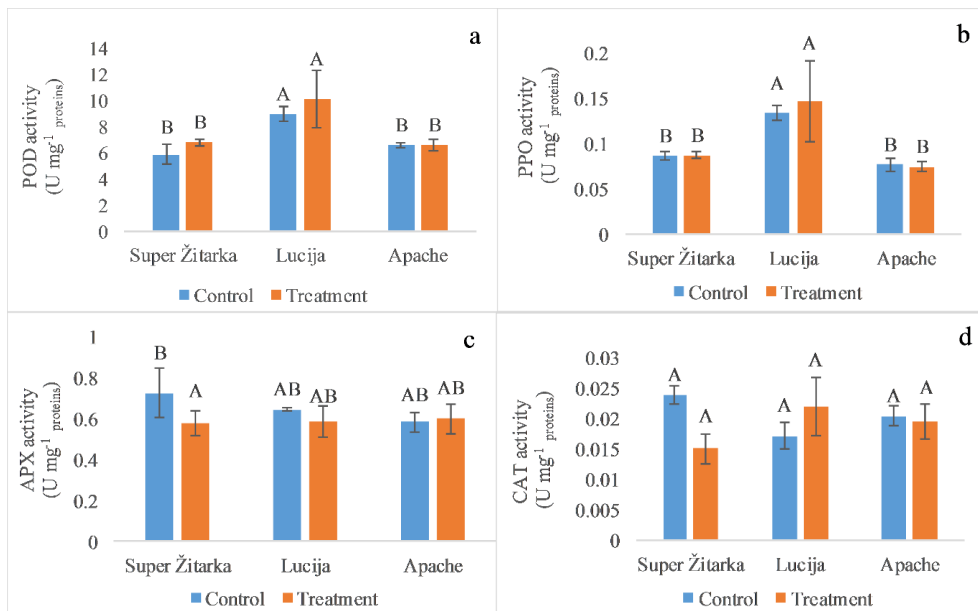

Fig. 1. Activity of POD (a), PPO (b) APX (c) and CAT (d) in ears of wheat genotypes ('Super Žitarka', 'Apache' and 'Lucija') infected with *Fusarium* spp. Values are means of five replicates ±SE. Different capital letters indicate significantly different values ($P < 0.05$) within each genotype and among different genotype under the same treatment

Comparing the H₂O₂ level among different wheat genotypes 'Super Žitarka' and 'Apache' showed significantly higher level of H₂O₂ than 'Lucija' in both control and infected plants (Fig. 2a). Differences in H₂O₂ concentration among tested genotypes could be a result of genetic variability (Cheeseman, 2007). Furthermore, higher H₂O₂ level (Fig. 2a) and decline in POD and PPO activity (Figs. 1a, 1b) in 'Super Žitarka' and 'Apache' under infection conditions, lead us on conclusion that both of genotypes might employ some other defence mechanism in a response to *Fusarium* attack. Considering MDA content, a product of lipid peroxidation, within each wheat genotypes revealed that under *Fusarium* stress in genotype 'Lucija' MDA content remarkably decreased compared to control plants (Fig. 2b) which could be related with induced POD and PPO activity (Figs. 1a, 1b)

and significantly reduced H_2O_2 concentration (Fig. 2a). Low MDA content together with decreased H_2O_2 concentration in stressed plants of 'Lucija' imply that in this genotype ROS scavenging enzymes have an important role in providing the membrane integrity (Racchi, 2013). Numerous studies in wheat cultivars showed the positive correlation between tolerance to environmental stress and ROS detoxifying enzymes (Caverzan et al., 2016 b; Rao et al., 2013; Talaat and Shawky, 2014). It is believed that proteins have an important role in defence process under pathogen attack (Tariq et al., 2016).

Genotype 'Lucija' showed significantly lower total soluble protein level under control and stress conditions contrarily to 'Super Žitarka' and 'Apache' (Fig. 2c), indicating that perhaps 'Super Žitarka' and 'Apache' perhaps activate some other defence mechanism against *Fusarium* stress. According to some authors, the expression of the proteins under FHB is determined by genotypic variations (Tariq et al., 2016; Vishwanath, 2011). In FHB-resistant wheat genotypes were noticed nine types of various proteins involved in FHB resistance (Zhang et al., 2013).

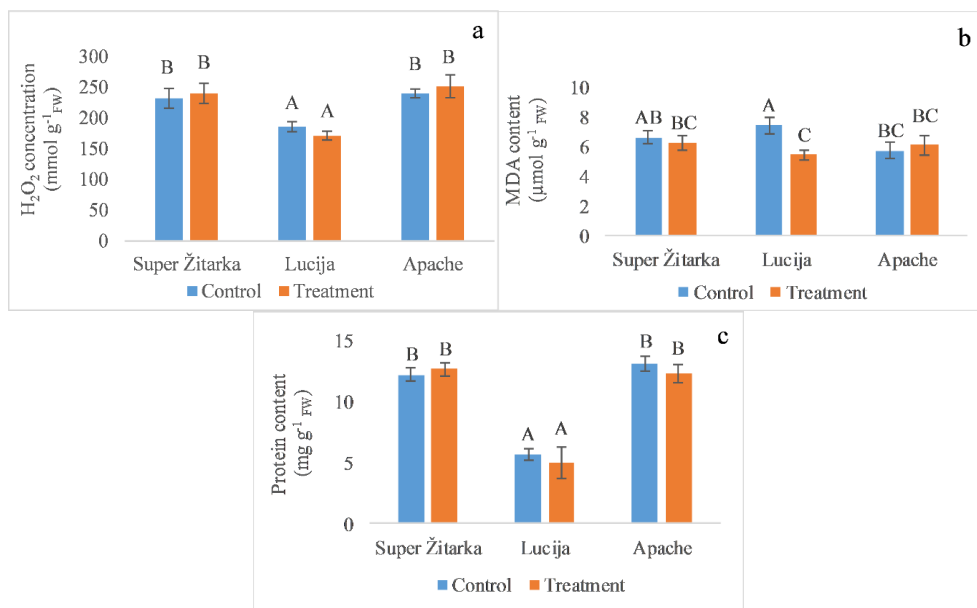

Fig. 2. H_2O_2 (a) and MDA content (b) and protein concentration (c) in ears of wheat genotypes ('Super Žitarka', 'Apache' and 'Lucija') infected with *Fusarium* spp. Values are means of five replicates \pm SE. Different capital letters indicate significantly different values ($P < 0.05$) within each genotype and among different genotypes under the same treatment

Conclusions

In conclusion, in genotype 'Lucija' increased POD and PPO activity accompanied with reduced concentration of H₂O₂ could explain why *Fusarium* spp. did not cause the degradation of cell membranes. Moreover, remarkable POD and PPO activities in 'Lucija' suggest that this wheat genotype showed more effective antioxidative response to *Fusarium* spp. than 'Super Žitarka' or 'Apache'. The differences in antioxidative response and protein concentration may be the result of their genetic properties.

Acknowledgments: This work has been supported in part by Croatian Science Foundation within the project HRZZ-UIP-2014-9188.

References

- Aebi, H. (1984): Catalase in vitro, *Meth. Enzymol.* 105, 121-126.
- Alcazar, D. M., Egea, C., Espin, A., Candela, M. E. (1995): Peroxidase isoenzymes in defense response of *Capsicum annuum* to *Phytophthora capsici*, *Physiol. Plant Pathol.* 94, 736-742.
- Altinok, H. H., Dikilitas, M. (2014): Antioxidant response to biotic and abiotic inducers for the resistance against fusarium wilt disease in eggplant (*Solanum melongena* L.), *Acta Bot. Croat.* 73 (1), 79-92.
- Boeckx, T., Winters, A. L., Webb, K. J., Kingston-Smith, A. H. (2015): Polyphenol oxidase in leaves; is there any significance to the chloroplastic localization?, *J. Exp. Bot.* 1-9.
- Bradford, M.M. (1976): A rapid and sensitive method for the quantitation of microgram quantities of protein utilizing the principle of protein-dye binding, *Anal. Biochem.* 72, 248-254.
- Bushnell, W. R. et al. (2010): Effects of deoxynivalenol on content of chloroplast pigments in barley leaf tissues, *Phytopathol.* 100, 33-41.
- Caverzan, A., Casassola, A., Patussi Brammer, S.: Reactive oxygen species and antioxidative enzymes involved in plant tolerance to stress. In: Shanker, A. K., Shanker, C. (eds.), *Abiotic and biotic stress in plants-recent advances and future perspectives.* <http://dx.doi.org/10.5772/61368> (July, 2016).
- Caverzan, A., Casassola, A. A., Brammer P. S. (2016 b): Antioxidative responses of wheat plants under stress, *Genet. Mol. Biol.* 39 (1), 1-6.
- Cheeseman, J. M. (2007): Hydrogen peroxide and plant stress: a challenging relationship, *Plant Stress* 1 (1), 4-15.
- Dat, J. et al. (2000): Dual action of the active oxygen species during plant stress responses, *Cell Mol. Life Sci.* 57, 779-795.
- Diamond, M. et al. (2013): The *Fusarium* mycotoxin deoxynivalenol can inhibit plant apoptosis-like programmed cell death, *Plos One* 8 (7), 1-8.
- Fung, F., Clark, R. F. (2004): Health effects of mycotoxins: a toxicological overview, *J. Toxicol. Clin. Toxicol.* 42, 217-234.
- Khatun, S., Bandyopadhyay, P.K., Chatterjee, N.C. (2009): Phenols with their oxidizing enzymes in defense against black spot of rose (*Rosa centifolia*), *Asian J. Exp. Sci.* 23, 249-252.
- Madad khah, E. et al. (2012): Enzymatic activities in roots of melon genotypes infected with *Fusarium oxysporum* f. sp. melonis race 1, *Sci. Hortic.* 135, 171-176.

- Mahajan, S., Tuteja, N., (2005): Cold, salinity and drought stresses: An overview. *Arch. Biochem. Biophys.* 444, 139-158.
- Mayer, A. M. (2006): Polyphenol oxidases in plants and fungi: going places? A review, *Phytochemistry* 67, 2318-2331.
- Miller, G. et al. (2009): Reactive oxygen species homeostasis and signalling during drought and salinity stresses, *Plant Cell Environ.* 33, 453-467.
- Nakano, Y., Asada, K. (1981): Hydrogen peroxide is scavenged by ascorbate - specific peroxidase in spinach chloroplasts, *Plant Cell Physiol.* 22, 867-880.
- Racchi, M.L. (2013): Antioxidative defenses in plants with attention to *Prunus* and *Citrus* spp., *Antioxidants* 2, 340-369.
- Rao, A. et al. (2013): Potential antioxidative activities improve salt tolerance in ten varieties of wheat (*Triticum aestivum* L.), *Am. J. Plant Sci.* 4, 69-76.
- Raymond, J., Rakariyatham, N., Azanza, J. (1993): Purification and some properties of polyphenol oxidase from sunflower seeds, *Phytochemistry* 34 (4), 927-931.
- Shahbazi, H. et al. (2010): Biochemical evaluation of resistance responses of potato to different isolates of *Alternaria solani*, *Phytopathology* 100, 454-459.
- Siegel, B. Z., Galston, W. (1967): The isoperoxidases of *Pisum sativum*, *Plant Physiol.* 42, 221-226
- Sorahinobar, M. et al. (2015): Differential antioxidative responses of susceptible and resistant wheat cultivars against Fusarium head blight, *Intl. J. Farm. & Alli. Sci.* 4 (3), 239-243.
- Sorahinobar, M. et al. (2016) Lack of association between *Fusarium graminearum* resistance in spike and crude extract tolerance in seedling of wheat, *Eur. J. Plant Pathol.* 144, 525-538.
- Shifrin, V. I., Anderson, P. (1999): Trichothecene mycotoxins trigger a ribotoxic stress response that activates c-Jun N-terminal kinase and p38 mitogen-activated protein kinase and induces apoptosis, *J. Biol. Chem.* 274, 13985-13992.
- Talaat, B., Shawky, T. (2014): Modulation of the ROS scavenging system in salt-stressed wheat plants inoculated with arbuscular mycorrhizal fungi, *J. Plant Nutr. Soil Sci.* 177, 199-207.
- Tariq, R. M. S. M., et al.: Dynamics of total proteins during stress alleviation in tomato infected with cucumber mosaic virus, *Peer J. Preprints*, CC BY 4.0 Open Access, <https://doi.org/10.7287/peerj.preprints.2105v1>. (June, 2016)
- Velikova, V. et al. (2000): Oxidative stress and some antioxidant systems in acid rain-treated bean plants: protective role of exogenous polyamines, *Plant Sci.* 151, 59-66.
- Verma, S., Dubey, R.S. (2003): Leads toxicity induces lipid peroxidation and alters the activities of antioxidant enzymes in growing rice plants, *Plant Sci.* 164, 645-655.
- Vishwanath, K. et al. (2011): Identification of tomato (*Lycopersicon esculentum*) varieties through total soluble seed proteins, *Res. J. Agr. Sci.* 2 (1), 8-12.
- Walter, S., Nicholson, P., Doohan, F. M. (2010): Action and reaction of host and pathogen during Fusarium head blight disease, *New Phytol.* 185, 54-66.
- Wang, Y., Yang, L., Xu, H., Li, Q., Ma, Z., Chu, C. (2005): Differential proteomic analysis of proteins in wheat spikes induced by *Fusarium graminearum*, *Proteomics* 5, 4496-4503.
- Zadoks, J.C., Chang, T.T., Konzac, F.C. 1974: A decimal code for the growth stages of cereals, *Weed Res.* 14, 415-421.
- Zhang, X., Fu, J., Hiromasa, Y., Pan, H., Bai, G. (2013): Differentially expressed proteins associated with Fusarium head blight resistance in wheat, *Plos One* 8 (12), 1-10.

Centri za ponovnu uporabu u funkciji zaštite okoliša

Tomislav Domanovac^{1*}, Marija Vuković Domanovac²

¹IPZ Uniprojekt TERRA, Voćarska cesta 68, 10000 Zagreb

²Sveučilište u Zagrebu, Fakultet kemijskog inženjerstva i tehnologije,

Marulićev trg 19, 10000 Zagreb, Hrvatska

*Dopisni autor: tomislav@ipz-uniprojekt.hr

Sažetak

Opterećenje okoliša sve većim količinama i različitim vrstama odbačenog otpada predstavlja problem koji već uzrokuje ozbiljne poremećaje u svim sastavnicama okoliša. Obrada otpada radi smanjenja njegove količine ili štetnog utjecaja na okoliš također proizvodi emisije u okoliš i značajne troškove za krajnjeg korisnika usluga. Iz navedenih problema dolazi se do zaključka da je potrebno promišljati gospodarenje tvarima i proizvodima na način da se na minimum smanji mogućnost nastajanja otpada te maksimalno iskoristi funkcionalnost predmeta koji bi odbacivanjem postali otpad. Temelji održivog razvoja postavljeni su, između ostalih i zakonima koji se odnose na zaštitu okoliša i održivo gospodarenje otpadom. Načelo predostrožnosti u zaštiti okoliša prilikom korištenja okoliša, između ostalog, podrazumijeva i izbjegavanje stvaranja otpada u najvećoj mogućoj mjeri. U skladu s navedenim, održivo gospodarenje otpadom primjenjuje red prvenstva, tj. hijerarhiju u primjeni propisa i provedbi politike gospodarenja otpadom, a povrh svega se to odnosi na sprječavanje nastanka otpada i pripremu za ponovnu uporabu. Središte sustava ponovne uporabe čini mreža centara za ponovnu uporabu (CPU) koji se sastoje od dijela za prihvata, popravke ili čišćenje te izložbenog, odnosno prodajnog prostora. U ovom radu se daje procjena potencijala, učinka na smanjenje količine otpada te mogućnosti održivog funkcioniranja sustava ponovne uporabe.

Ključne riječi: otpad, centar za ponovnu uporabu, zaštita okoliša

Uvod

Aktivnosti vezane za izbjegavanje otpada i ponovnu uporabu predmeta i materijala prije nego li postanu otpad, hijerarhija gospodarenja otpadom u Republici Hrvatskoj je postavila na vrh prioritetnih aktivnosti (Zakon o održivom gospodarenju otpadom, NN 94/2013). Centri za ponovnu uporabu (CPU) predstavljaju pravni subjekt čija je aktivnost sakupljanje, obnova i ponovna distribucija proizvoda koji bi u suprotnom postali otpad. Kako to praksa u EU zemljama pokazuje (CERREC (2012)), aktivnosti CPU-a usmjerene su i na aktivnosti pripreme za ponovnu uporabu u slučaju kada se radi o otpadu, a prodajom proizvoda novom vlasniku ukida se i status otpada. Za razliku od sličnih pojava oblika opisanih djelatnosti, poput sajmišta, humanitarnih akcija i sl., CPU su svojom djelatnošću ovlaštene za navedene aktivnosti budući da posluju kao tvrtke socijalnog karaktera te otvaraju nova radna mjesta i mogućnosti usavršavanja radnih vještina i znanja.

Vezano uz navedene aktivnosti važno je poznavati značenje pojmova iz ovog područja. Otpad je svaka tvar ili predmet koji posjednik odbacuje, namjerava ili mora odbaciti. Ponovna uporaba je svaki postupak kojim se omogućava ponovno korištenje proizvoda ili dijelova proizvoda koji svome izvornom vlasniku više nisu potrebni, kako ne bi postali otpad, a koriste se u istu svrhu za koju su izvorno načinjeni. Priprema za ponovnu uporabu obuhvaća postupke oporabe kojima se proizvodi, ili dijelovi proizvoda koji su odbačeni kao otpad, provjerom, čišćenjem ili popravkom pripremaju za ponovnu uporabu bez prethodne obrade u svojstvu otpada. Centar za ponovnu uporabu je poslovni subjekt upisan u Očevidnik centara za ponovnu uporabu, koji materijale, predmete i druga dobra s ciljem ponovne uporabe prikuplja, priprema i distribuira prije nego steknu status otpada, a ukoliko su zadovoljeni zakonski uvjeti, otpadne predmete i materijale pripremaju za ponovnu uporabu te na taj način stvaraju preduvjete za ukidanje statusa otpada. Mreža za ponovnu uporabu je veći broj poslovnih subjekata koji zajednički djeluju u cjelokupnom procesnom lancu ponovne uporabe, dijeleći zadatke sukladno svojim pojedinačnim specijalizacijama. Ukoliko se mreža upisuje u očevidnik CPU tada je ista odgovorna za djelovanje svih svojih članica. Postupci pripreme za ponovnu uporabu su postupci provjere, čišćenja i popravaka kojim se predmeti ili njihovi dijelovi, koji su već stekli status otpada, pripremaju kako bi se mogli ponovno uporabiti, bez drugih postupaka obrade u svojstvu otpada. Postupci gospodarenja otpadom su: sakupljanje otpada, interventno sakupljanje otpada, priprema za ponovnu uporabu, priprema prije oporabe i zbrinjavanja, postupci oporabe i zbrinjavanja, trgovanje otpadom, posredovanje u gospodarenju otpadom, prijevoz otpada, energetska oporaba određenog otpada, sakupljanje otpada u reciklažno dvorište (RD) i privremeno skladištenje vlastitog proizvodnog otpada. Ukidanje statusa otpada je administrativni postupak kojim se određenom otpadnom predmetu ili materijalu daje status predmeta ponovne uporabe, odnosno materijala za ponovnu uporabu, čime prestaje biti otpad u smislu potrebe za provođenjem postupaka obrade u svojstvu otpada. Predmet, odnosno materijal, mora pritom udovoljavati kriterijima utvrđenim u skladu sa sljedećim uvjetima: a) materijal ili predmet uobičajeno se koriste za određene namjene; b) za takav materijal ili predmet postoji tržište i potražnja; c) materijal ili predmet ispunjavaju tehničke zahtjeve za određene namjene i zadovoljavaju postojeće propise i tehničke norme koje važe za takve materijale i proizvode; d) uporaba materijala ili predmeta neće dovesti do ukupnih štetnih učinaka na okoliš ili zdravlje ljudi. Predmeti ili proizvodi se putem CPU mogu skupljati izravno od korisnika, u prostorima CPU ili putem akcija sakupljanja bez posebnih dozvola. Također, navedeni predmeti ili proizvodi mogu se skupljati i od vrata do vrata, putem specijaliziranih spremnika ili RD-a uz upis u Očevidnik centara za ponovnu uporabu. Svi predmeti koji su postali otpad, mogu se prikupljati uz ishođenje dozvole za gospodarenje otpadom.

Tehnički opis i tehnologija rada

Građevina CPU i potrebna oprema

Blizina RD objektima CPU predstavlja značajnu prednost jer se međusobno koordiniranim djelovanjem mogu određeni potencijalno iskoristivi predmeti s RD preusmjeriti na CPU. Minimalni uvjeti za razvoj svih sadržaja CPU ostvaren je na oko 530 m² zatvorenog ili natkrivenog prostora gdje se provodi prihvata, popravak i prodaja predmeta. Shematski prikaz osnovnih prostora CPU dan je na slici 1.

Zaštita okoliša / Environmental Protection

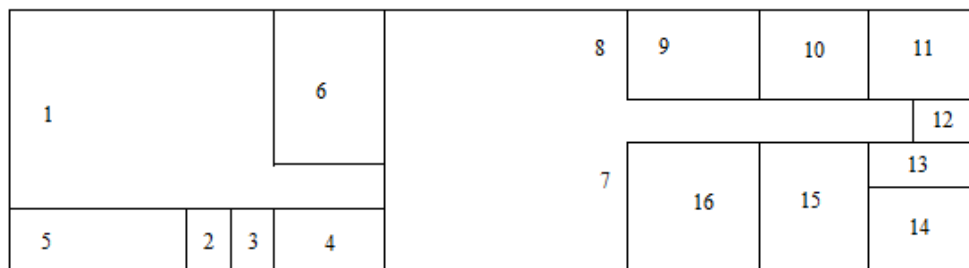

Legenda: 1. Prodajno/izložbeni prostor, 2. i 3. Sanitarni čvor (M, Ž), 4. Garderoba, 5. Ured, 6. Skladište gotovih proizvoda, 7. Prethodna provjera, 8. Prihvatni prostor, 9. Ulazno skladište, 10. Elektro radionica, 11. Praonica i čistionica, 12. Spremište materijalnih sredstava, 13. Peglanje i šivanje, 14. i 15. Stolarska radionica (površinska zaštita i obrada materijala), 16. Montaža

Slika 1. Shematski prikaz osnovnih prostora CPU

Fig. 1. Schematic representation of the basic premises of RC

Također, prostor CPU uključuje i parkiralište za korisnike i djelatnike CPU-a te prometno-manipulativnu površinu za prihvata i isporuku predmeta. Svi prostori su izgrađeni i opremljeni u skladu s važećim standardima zaštite okoliša i ljudskog zdravlja, odnosno u skladu s propisima sigurnosti na radu i zaštite od požara. Ovisno o trenutnim potrebama i kapacitetima, moguće je fleksibilno koristiti navedene radioničke prostore budući da se predviđaju široka vrata za što lakšu komunikaciju između unutarnjih prostora stolarije i montaže prilikom prijenosa predmeta, kao i komunikacija stolarije i montaže s vanjskim prostorom. U prostorima je osigurano prikladno grijanje, hlađenje i prirodno provjetranje (dodatno otprašivanje u prostorima stolarije i montaže). Objekt CPU može se sastojati i od fotonaponske elektrane smještene na krovnoj površini CPU. Predviđena je fotonaponska elektrana snage 20 kWp. Vozilo, mobilna oprema, služi za skupljanje ili prijevoz predmeta ili otpada prikazano je slikom 2.



Slika 2. Mobilna oprema - vozilo na električni pogon

Fig. 2. Mobile equipment - electric vehicle

CPU je opremljen sljedećom opremom: 1. Oprema za vaganje, 2. Oprema za rukovanje i skladištenje robe (npr. viličari, kolica i sl.), 3. Oprema za čišćenje, popravak i izlaganje predmeta (kemijska sredstva za kućanstva, alati, radni stolovi, police, regali i sl.), 4. Oprema za administrativne poslove (katalogizaciju predmeta, vođenje skladišta, ispunjavanje potrebne dokumentacije i dr.), 5. Oprema za informativno-edukacijske svrhe (panoi i sl.), 6. Oprema za zaštitu okoliša i zaštitu na radu, 7. Mobilna oprema (vozilo za skupljanje ili prijevoz predmeta ili otpada), 8. Ostalo (protupožarna oprema, oprema zaštite na radu, oprema za održavanje instalacija CPU, reklamno-informativni panoi i dr.).

Tehnologija rada CPU

Radno vrijeme CPU je prilagođeno korištenju od strane građana te je usklađeno s radom RD-a radi koordiniranog djelovanja prilikom preuzimanja predmeta ili otpada od građana. Korisnik CPU dovozi se do *ulazne zone* gdje može parkirati vozilo ili može vozilo dovesti do same prihvatne zone za istovar većih ili težih predmeta pri čemu djelatnici CPU pomažu donositelju prilikom istovara. Alternativno postoji mogućnost dolaska djelatnika CPU po pozivu korisnika usluga CPU radi predaje uglavnom većih, glomaznih predmeta. Tada se s korisnikom usluga CPU dogovara termin dolaska djelatnika CPU (ovlaštena osoba u CPU vodi, planira i određuje raspored obilaska područja radi prethodne provjere i preuzimanja predmeta, bez naknade za izlazak na teren) radi prethodne provjere predmeta te se u slučaju prihvatljivosti predmeta provodi administrativna procedura primitka predmeta.

Predmeti se predaju ovlaštenoj osobi CPU koja provodi *prethodnu provjeru* tehničko-higijenske ispravnosti predmeta. Ukoliko predmet zadovoljava uvjete za daljnje postupanje u CPU (voditelj CPU ima pravo ne primiti određene vrste dobara: radi zaštite sigurnosti radnika u CPU, predugog vremena skladištenja određenih vrsta predmeta ili uočavanja kršenja pravila CPU vezano za prihvata – npr. broj predanih predmeta ili broj dolazaka u CPU), tada se provodi *administrativna procedura primitka predmeta* od strane korisnika CPU, tj. ispisuje se donatorska potvrda koja se potpisuje od strane donositelja i primatelja predmeta. *Prijedlozi potvrde o donaciji, obrasca za sistematizaciju primitka, imenika za katalogizaciju te Izjave korisnika - kupca* objavljeni su u dokumentu Fonda za zaštitu okoliša i energetska učinkovitost (FZOEU) vezanim za provedbu ponovne uporabe (ESPER (2016): Smjernice za ponovnu uporabu u RH, FZOEU).

Ukoliko se prethodnom provjerom ustanovi da je *predmet neiskoristiv za prodaju ili popravak*, tada se isti smješta u prihvatne spremnike za izdvojeno skupljeni otpad ili se isti *odnosi u RD* (alternativno, u slučaju dolaska djelatnika CPU na adresu korisnika CPU, neiskoristivi predmet se ne preuzima, već se korisniku CPU sugerira predaja otpada na RD-u). Naime, idealna lokacija CPU je u neposrednoj blizini RD gdje se, u koordinaciji s ovlaštenim osobljem CPU i RD, provode procedure prepoznavanja i preusmjerenja predmeta za ponovnu u CPU i obrnuto. Na taj način se izbjegava dvostruko ili neadekvatno bilježenje predmeta, odnosno otpada prilikom ulaska predmeta ili otpada u postupke reciklaže ili ponovne uporabe. Ukoliko je doneseni predmet u potpunosti ispravan, može ga se, nakon *administrativnog zapisa*, smjestiti u skladište gotovih proizvoda ili izravno u izložbeno-prodajni prostor.

Izložbeno-prodajni prostor (slika 3.) zamišljen je poput uređenog trgovačkog prostora opremljenog i dekoriranog u skladu s pravilima estetskog uređenja interijera s dovoljno prostora za kretanje posjetitelja, uz stvoreni ugodni ambijent (osvježenje prostora osvježivačima, glazbena kulisa i dr.).

Zaštita okoliša / Environmental Protection

Uz svaki proizvod izvešana je maloprodajna cijena, a naplata se provodi na fiskalnoj blagajni smještenoj na ulazno-izlaznoj zoni (<http://www.bistra.si/otvoritev-centra-ponovne-uporabe-naptuju/>; (08.09.2016.)). Alternativno se kao dio izložbenog prostora može koristiti i *virtualni prostor* putem internetske stranice ili društvenih mreža. Na istima se može omogućiti informiranje o ponudi, mogućnost rezervacije, upita ili eventualno internetske prodaje (<https://web.facebook.com/centerponovneuporabevelenje/>; (08.09.2016.)).



Slika 3. Prodajno-izložbeni prostor CPU Velenje, Slovenija: izložbeni-prodajni salon (lijevo) i virtualni izložbeni prostor (desno)

Fig. 3. The sales-showroom RC Velenje, Slovenia: showroom (left) and a virtual showroom (right)

U slučaju da su uočeni manji nedostaci, može ga se smjestiti u ulazno skladište ili ga se u *radnoj zoni* privodi svojoj svrsi i omogućiti daljnja prodaja. Ovisno o kategoriji i tipu primljenih predmeta, odnosno vrsti potrebnih popravaka ili drugih radnji, predmeti se ručno ili pomoću kolica ili ručnog viličara odnose u jednu od radionica (slika 4.) (<http://www.dominstil.si/articles/fotozgodbe/3103/nove-zgodbe-za-rabljene-predmete/> (08.09.2016.); <https://www.gorenjskiglas.si> (08.09.2016.); <http://www.rtv slo.si/okolje/novice/z-obnavljanjem-predmetov-zmanjsujejo-odpadke-in-nudijo-zaposlitev/279193> (08.09.2016.)). U *elektro radionici* se ispituju određene električne ili elektronske komponente te, ovisno o slučaju iste se nadomještaju ispravnim dijelovima iz priručnog spremišta komponenti (zamjena neispravnog kabla, elektroničkih komponenti i dr). U dijelu *stolarske radionice* predmetima se uklanjaju stari ili se nanose novi premazi (boje, lakovi i sl.). Ovisno o vrsti predmeta i potrebama privođenja svrsi istih, koriste se sredstva za površinsku zaštitu koja su prihvatljiva za okoliš i ne ugrožavaju ljudsko zdravlje niti sigurnost radnika prilikom njihovog korištenja. U drugom dijelu stolarske radionice obavlja se ručna i strojna obrada materijala (rezanje, blanjanje, struganje, lijepljenje). Očekuje se da će se većinu primljenih predmeta morati na nekakav način očistiti ili oprati prikladnim sredstvima (ukloniti prašinu, raznovrsnu prljavštinu, dezinficirati i sl.). Za navedene aktivnosti namijenjena je *praonica* i *čistionica*. Sredstva koja se koriste u praonici su sredstva koja se koriste i u kućanstvima.

Prostor *montaže* je predviđen za obavljanje konačnih radnji ili popravaka predmeta prije mogućnosti njihovog smještaja u prodajno izložbeni prostor ili skladište gotovih proizvoda.



Slika 4. Radionice
Fig. 4. Workshops

Količine ponovno uporabljenih predmeta ili proizvoda te gospodarenje otpadom na CPU

Prilikom obavljanja aktivnosti na CPU nastaju i određene vrste otpada. Neke vrste otpada prepoznaju se prilikom prethodne provjere prilikom dolaska donositelja. Iskustva iz zemalja u kojima su primijećeni uspješni rezultati koncepta ponovne uporabe ("reuse") pokazuju da oko 33 % svega što se donese na RD ima potencijal za ponovnu uporabu (RREUSE (2014)), od 17 % (namještaj) (WRAP (2011a)) do 50 % (odjeća – nije predviđeno u ovom CPU) (WRAP (2011b)) na CPU donesenih predmeta ili proizvoda je ponovno korišteno, te oko 25 % električnih i elektroničkih (EE) predmeta ima potencijal za ponovnu uporabu (RREUSE (2015)). Ostatak neprodanih ili nedoniranih proizvoda, odnosno predmeta, iskorištava se za popravke ili je poslan na reciklažu ili uporabu. Na temelju pretpostavljenih količina otpada od 1.000 t/god, koje se prikupljaju putem nekog prosječnog reciklažnog dvorišta, procjenjuje se da godišnje oko 145 tona otpadnog namještaja, oko 30 t EE otpada i oko 15 t ostalih predmeta ili proizvoda ima potencijal za ponovnu uporabu, tj. ukupno oko 190 t/god. Ako se pretpostavi da se oko 17 % namještaja, odnosno oko 25 % EE predmeta iskoristi, onda se procjenjuje količina otpada za recikliranje ili zbrinjavanje u iznosu od oko 121 t otpadnog namještaja (pretežno od drveta), oko 11 t ostalog otpada i oko 22 t EE otpada. Kada se navedenim procijenjenim količinama doda i otpad koji je nastao popravkom ili obnovom iskorištenih predmeta, tada se ukupna količina otpada s CPU procjenjuje na oko 157 t/god. Dakle, pretpostavlja se da bi putem CPU oko 3,6 % predmeta, tj. oko 36 t/god od ukupnih količina otpada skupljenog putem RD-a, bilo ponovno uporabljeno.

Zaštita okoliša / Environmental Protection

Sve *posebne vrste otpada* koje preostaju nakon popravaka ili obnove predmeta u CPU, predaju se ovlaštenom skupljaču. Svi *iskoristivi otpadni materijali* koji nastane nakon obavljanja opisanih radnji odvojeno se skuplja i predaje ovlaštenom skupljaču radi reciklaže ili uporabe. *Miješani komunalni otpad*, odnosno drugi *proizvodni opasni ili neopasni otpad* predaje se ovlaštenom skupljaču na obradu. Vrijeme predaje otpada ovlaštenom skupljaču, odnosno premještaj otpada na odgovarajuće mjestu u RD-u, treba svesti na minimum, odnosno otpad se odmah odnosi s lokacije CPU radi onemogućavanja akumuliranja veće količine otpada i smanjenja raspoloživog prostora za osnovnu djelatnost CPU.

Radna snaga na CPU

Pretpostavljen je rad na CPU u dvije smjene, pet dana u tjednu te subotom u prvoj smjeni. U drugoj smjeni u CPU je za korisnike otvoren prodajno-izložbeni prostor. Oprema i objekti trebaju biti čuvani 24 sata (video nadzor ili zajednička čuvarska služba kada je CPU smješten uz RD). Za normalno poslovanje CPU potrebno je 5 zaposlenika: jedan voditelj-prodavač i ujedno administrator, te po jedan stolar, strojar-montažer, elektrotehničar i KV radnik. Daljnje zapošljavanje se vrši etapno i ovisi o obujmu potrebnog rada kojeg treba realizirati unutar CPU.

Interni i vanjski transport na CPU

Unutar CPU obavlja se interni transport između zatvorenih prostora objekta, odnosno postoji kontakt s vanjskim prostorom (nadstrešnica i otvoreni prostor između CPU i RD). Navedeni transport se odnosi na prijevoz pomoću ručnih kolica ili viličara, odnosno ručni prijenos predmeta. Vanjski transport koji se odnosi na aktivnosti CPU odnosi se na prijevoz iskoristivih predmeta ili proizvoda od korisnika s njihove lokacije (adrese), i to pomoću namjenskog vozila CPU – kamiona, npr. na električni pogon.

Mjere zaštite okoliša na CPU

Mjere zaštite okoliša i ostale mjere za siguran rad, iznose se u nastavku:

- na ulazu provoditi kontrolu predmeta koje donositelj želi donirati u CPU,
- izdvojene količine otpada nastalog unutar CPU ili prilikom faze zaprimanja od donositelja (ako donositelj sam ne premjesti otpad u RD) treba držati u odgovarajućim uvjetima koji onemogućavaju ulaz oborina u prostor držanja otpada ili eventualni nekontrolirani izlaz tekućina iz prostora ili spremnika za skladištenje otpada,
- zaštitu podzemnih i površinskih voda osigurati izgradnjom i održavanjem vodonepropusne podloge s barijerama za sprečavanje nekontroliranog površinskog otjecanja na dijelu lokacije na kojem se manipulira s donesenim predmetima, otpadom ili se otpad skladišti, kao i pomoću sustava nepropusne interne kanalizacije spojene na separator ulja i masti i taložnika krutih čestica prije ispuštanja u sustav javne odvodnje,
- zaštitu od buke osiguravati pravilnim korištenjem niskobučne opreme, prema mogućnostima u zatvorenom dijelu objekta CPU,
- zaštitu od eventualnog prekomjernog stvaranja prašine osiguravati izgradnjom i održavanjem ventilacijskog sustava u dijelu prostora CPU (stolarija i montaža),
- koristiti po mogućnostima sredstva i proizvode koji su neškodljivi za okoliš i ljudsko zdravlje.

Utrošak materijala, vode i energije

Procjena utroška materijala je otežana jer najvećim dijelom ovisi o količini i kvaliteti predmeta i proizvoda u CPU. Međutim, na temelju procjena potrebnih vrsta radova, količina raznih vrsta premaza, sredstava za čišćenje, alata i setova pomoćnih potrošnih radnih sredstava, u raznim vrstama i količinama pakiranja, procjenjuje se na godišnjoj razini na oko 350 L raznih tekućih materijalnih sredstava i 60 kg raznih čvrstih predmeta (čavli, vijci.). Navedeni materijali i sredstva se čuvaju u prikladnom skladištu te se nadopunjuju periodički, odnosno po potrebi. Na temelju procijenjenog broja potrebnih profila zaposlenika u CPU, procjenjuje se godišnji utrošak vode oko 150 L za sanitarne potrebe, odnosno oko 80 L tehnološke vode. Ukupna procjena za potrebnom vodom iznosi oko 230 m³/god, što ujedno predstavlja i količinu otpadne vode. Instalirana snaga elektro potrošača CPU iznosi oko 96 kW, a procijenjeni godišnji utrošak električne energije procjenjuje se na oko 60 MWh.

Procjena ulaganja u objekt i opremu CPU te procjena troškova rada

Investicija

U tablicama 1. i 2. prikazana je procjena potrebnih ulaganja u objekt i opremu CPU bez PDV-a.

Tablica 1. Procjena ulaganja u objekt CPU

Table 1. Estimated investment of the RC – civil work

Objekt	Ukupni iznos, kn
Prometno-manipulativna površina	524.000
Montažni objekt sa infrastrukturnim priključcima	2.300.000
Prihvatni prostor s nadstrešnicom	310.000
Ventilacijski sustav	27.000
Fotonaponska elektrana, 20 kW	464.000
Ukupno objekt:	3.625.000

Tablica 2. Procjena ulaganja u opremu CPU

Table 2. Estimated investment of the RC – equipment

Oprema	Ukupni iznos, kn
Strojevi, alati, zaštitna oprema i sl.	108.000
Namještaj	160.000
Uredska oprema	75.000
Vozilo	300.000
Ukupno:	643.000

Zaštita okoliša / Environmental Protection

Procjenjuje se da je u objekt i opremu CPU-a potrebno utrošiti oko 4.268.000 kuna bez PDV-a. Mogući izvori financiranja su razni europski fondovi, FZOEU i dr.

Ukupni troškovi

U procjeni ukupnih troškova uračunati su svi troškovi za redovni rad CPU-a, tj. operativni troškovi, iznos amortizacije, bez cijene kapitala (kamate). Prilikom procjene troškova radne snage vodilo se računa o minimalnim mjesečnim neto primanjima, a prosječna neto plaća zaposlenika je oko 3.200 kuna mjesečno, odnosno oko 44 % niža od prosječne neto isplaćene plaće u RH u 2015. godini (Državni zavod za statistiku, NN 22/2016).

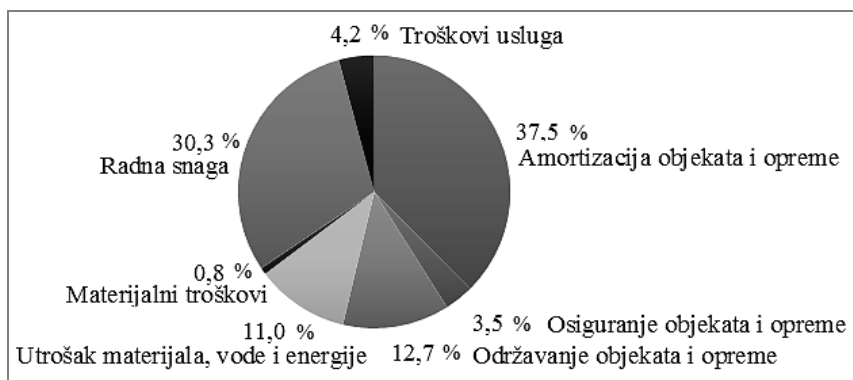

Slika 5. Procjena ukupnih troškova rada CPU-a

Fig. 5. Estimated total costs of the RC

Procjena strukture ukupnih troškova rada CPU-a (slika 5.) uključuje troškove amortizacije, osiguranja, održavanja, utroška materijala, energenata i vode, troškove radne snage, materijalne troškove i troškove usluga. Procijenjeni ukupni troškovi rada opisanog CPU-a iznose oko 710.000 kuna godišnje. Ukoliko se ukupni troškovi umanje za potencijalne prihode od prodaje izloženih predmeta u vrijednosti jedne prosječne bruto godišnje plaće zaposlenika CPU-a, te za proizvedenu električnu energiju iz fotonaponske elektrane, dakle sveukupno oko 93.660 kn/god prihoda, specifični ukupni troškovi rada CPU iznose visokih oko 17.230 kn/t obnovljenih ili popravljenih predmeta koji su ponovno vraćeni na tržište. U ovom slučaju pokrivanje troškova rada CPU-a prihodima iznosi oko 13,2 %, što znači da ovakav sustav može funkcionirati samo uz značajne subvencije.

Pokrivanje ukupnih troškova rada CPU-a moguće ostvariti na više načina, od povećanja ukupnih količina ili udjela potencijalno iskoristivog otpada koji se sada odlaže na reciklažnim dvorištima (npr. odbačeni predmeti s manje oštećenja, za odbačenim predmetima postoji veća potražnja na tržištu), pa do povećanja udjela prodanih, tj. iskorištenih obnovljenih ili popravljenih predmeta (npr. promidžbenim akcijama koje su usmjerene na smanjenju konzumerističke kulture, unikatnim kreacijama od obnovljenih predmeta, popravljenim ili obnovljenim predmetima izrađenih od kvalitetnih materijala, obnovljenih predmeta koji imaju određenu kulturno-povijesnu vrijednost).

Stoga, ako se pretpostavi povećanje potencijalno iskoristivih predmeta od $2,5\times$ (procijenjeni potencijal za ponovnu uporabu iznosio bi oko 2,58 % od ukupnih količina otpada predmetnog područja) te ukoliko se povećanjem iskorištenja prihod od prodaje obnovljenih predmeta poveća za oko $9\times$ u odnosu na pretpostavljena početna iskustva sa sličnih objekata, moguće je održivo funkcioniranje CPU-a, uz ukupni trenutni učinak na smanjenje količine otpada od oko 2,1 % od ukupnih količina otpada predmetnog područja.

Zaključci

Centri za ponovnu uporabu predstavljaju podsustav cjelovitog sustava gospodarenja otpadom koji izravno utječe na izbjegavanje i smanjenje nastanka otpada produljenjem korisnog vijeka određenog proizvoda ili predmeta. Realizaciju i rad CPU-a potrebno je u početku poduprijeti subvencijama (procijenjena pokrivenost troškova rada prihodima na CPU iznosi oko 13,2 %) budući da trenutno ne postoji dovoljna socijalno-karitativna i ekološka osviještenost u društvu.

Osim osobnih poticaja pojedinca na smanjenje potrošačkog mentaliteta, potrebno je političkim odlukama i ekonomskim poticajima promicati ovakve i slične kampanje koje podržavaju očuvanje kulturno-materijalne baštine, podupiru radnu kreativnost i produktivnost, smanjuju količinu otpada i pridonose očuvanju prirodnih resursa. Na ovaj način bi se učinak CPU-a na smanjenje ukupnih količina otpada povećao za oko $11\times$, uz održivost funkcioniranja CPU-a.

Učinke rezultata programa centara za ponovnu uporabu moguće je sagledati u sklopu dugoročnih, složenih odnosa unutar određenog društva, ali svakako pridonose održivom razvoju i zaštiti okoliša, a time i kvaliteti života, kao socijalno i ekološki senzibiliziranih pojedinaca, tako i onih socijalno potrebitih osoba.

Literatura

CERREC (2012): Summary Report – Re-use Framework, Conditions Central Europe Repair & Re-use Centres and Networks.

Državni zavod za statistiku, Narodne novine br. 22/2016.

ESPER (2016): Smjernice za ponovnu uporabu u Republici Hrvatskoj, FZOEU.

<http://www.bistra.si/otvoritev-centra-ponovne-uporabe-na-ptuju/>; (08.09.2016.).

<http://www.dominstil.si/articles/fotozgodbe/3103/nove-zgodbe-za-rabljene-predmete/>;

(08.09.2016.).

<http://www.rtvsllo.si/okolje/novice/z-obnavljanjem-predmetov-zmanjsujejo-odpadke-in-nudijo-zaposlitev/279193/>; (08.09.2016.).

<https://web.facebook.com/centerponovneuporabevenje/>; (08.09.2016.).

<https://www.gorenjskiglas.si/>; (08.09.2016.).

RREUSE (2014): Approved Re-use Centres and Networks – Principles, pp.1.

RREUSE (2015): Briefing on job creation potential in the re-use sector, pp.4.

WRAP (2011a): Benefits of Reuse, Case Study: Domestic Furniture, pp.3.

WRAP (2011b): Benefits of Reuse, Case Study: Clothing, pp.3.

Zakon o održivom gospodarenju otpadom, Narodne novine br. 94/2013.

Professional paper

The reuse centres in environmental protection

Tomislav Domanovac^{1*}, Marija Vuković Domanovac²

¹IPZ Uniprojekt TERRA, Voćarska cesta 68, 10000 Zagreb, Croatia

²University of Zagreb, Faculty of Chemical Engineering and Technology,
Marulićev trg 19, 10000 Zagreb, Croatia

*Corresponding author: tomislav@ipz-uniprojekt.hr

Summary

Increasing quantities of different types of discarded waste in the environment is a problem that has already caused serious disruption in all environmental components. The treatment of waste in order to reduce its quantity or environmental impact also produces environmental emissions and significant costs to the end user. Due to these problems, it can be concluded that it is necessary to rethink the management of substances and products so as to reduce to a minimum the waste generation, and maximize the functionality of objects that would by rejecting become waste.

The foundations of sustainable development are set, among others, by the laws relating to environmental protection and sustainable waste management. The precautionary principle in environmental protection when using the environment, among other things, means avoiding the generation of waste as far as possible. Accordingly, sustainable waste management applies order of priority, a hierarchy in the application of rules and implementation of waste management policy, and above all this applies to waste prevention and preparation for re-use.

The focus of the system is on a network of re-use centres (RC), which comprise part of the acquisition, repair or cleaning, exhibition or sales area. In this paper the potential of the system, the effect on the reduction of waste and the possibility of sustainable functioning of the system of re-use is assessed.

Keywords: waste, centre for reuse, environmental protection

Original research paper

The possibility of using treated compost leachate as hydroponic solution

Lidija Fras Zemljčič^{1*}, Marjana Simonič², Olivera Šaupperl¹, Rok Mihelič³

¹University of Maribor, Faculty of Mechanical Engineering, Smetanova 17, 2000 Maribor, Slovenia

²University of Maribor, Faculty of Chemistry and Chemical Engineering,
Smetanova 17, 2000 Maribor, Slovenia

³University of Ljubljana, Biotechnical Faculty, Jamnikarjeva 101, 1000 Ljubljana

*Corresponding author: lidija.fras@um.si

Summary

Compost leachate is byproduct of organic waste decomposition. During the process of degradation of organic waste, water is formed as compost leachate, which slowly flows through the compost, therefore become rich in dangerous substances, such as heavy metals. The cleaning approach of compost leachate presented in this paper is directed towards chelating pre-treatment procedures. Nontoxic and biodegradable biopolymer chitosan in the form of nanoparticles was used for this purpose at different chemical conditions. After physio-chemical separation (centrifugation) of the aqueous filtrate from the concentrated chitosan chelates, the supernatant was analyzed regarding pH, κ , turbidity, heavy metals, germination and the phosphorus content with the aim to estimate the cleaning efficiency of chitosan within the compost leachate. Due to the presence of a high amount of organic substances, the supernatant may be examined as a plant nutritional agent, applicable for soil-care, especially for sports facilities (football, golf courses, stadium), etc.

Thus, the compost leachate supernatant was also estimated toward to the requirements for plant nutritional substrate: i.e. to verify the usefulness of the germination tests by using seeds of garden cress (*Lepidium sativum* L.).

Keywords: compost leachate, chitosan nanoparticles, metals, fertilizer, germination test.

Introduction

The content of heavy metals and organic pollutants within compost leachate should be removed to such extent that the water can be discharged into the sewerage, or in natural waterways, or can be used as fertilizer. Biodegradable polymer chitosan adsorbs fats, oils, heavy metals, and similar toxic substances, therefore it can be added to the biological, or chemical part of wastewater cleaning, because it acts as a coagulant, flocculants, chelator, etc. (Strnad et al., 2007). Chitosan is a cationic polysaccharide (Savage and Tyrrel, 2005, Tyrrel et al., 2008, Bassi et al., 2000). It has favorable properties in terms of increasing the value of the total carbon within the compost leachate water, with the possibility to bind variety of inorganic and organic matters onto surface, especially in its coiled-like conformation that introduces higher specific area (Romero et al., 2013). In this work chitosan nanoparticles were used in order to eliminate metals from compost leachate.

Zaštita okoliša / Environmental Protection

Materials and Methods

Preliminary experiments by using modelling solutions of Zn ($\text{Zn}(\text{CH}_3\text{COO})_2$) and Cu ($\text{CuSO}_4 \times 5\text{H}_2\text{O}$) were first performed in order to determine the most efficient activity of chitosan nanoparticles by metal removal; i.e. to find out at which concentration and pH of chitosan nanoparticles dispersion the content of Cu in Zn metals is reduced to minimum. The experiment was then performed with the real compost leachate at conditions which were proved to be the most optimal in the case of modelling solutions. The details are given below.

Preparation of Modelling Solutions

The purpose of this experiment is to determine the optimal procedures of metal binding onto chitosan nanoparticles from modelling solutions. For this purpose following solutions were used: ($\text{Zn}(\text{CH}_3\text{COO})_2$, $\gamma = 1 \text{ g/L}$, and $\text{CuSO}_4 \times 5\text{H}_2\text{O}$, $\gamma = 1 \text{ g/L}$), and mixture of both in 1:1 volume ratio. Modelling solution represents a single and binary system of metals, so the use of solutions of the individual metals can provide information on the knowledge of chitosan affinity to specific metals and, consequently, the creation of optimal conditions for individual metal. This can serve as a support for the purification of the real compost water representing a multi-metal system. After treatment with chitosan nanoparticles, each modelling solutions were centrifuged, so the supernatants were analyzed in order to determine residual metal content. The initial and final concentrations of Zn and Cu ions was measured at pH = 4, 5 and 6.

Preparation of Treatment Solutions

Preparation of Chitosan Solution

2.5 g of chitosan powder (molecular weight 82.000, degree of deacetylation 77.4 %, Kitozyme, Belgium) was suspended into 200 mL of distilled water in 250 mL flask. Dissolution was achieved by the addition of a few mL of concentrated acetic acid (CH_3COOH). By heating the solution at temperature of $T = 40 \text{ }^\circ\text{C}$ under constant stirring ($t = 2 \text{ h}$), the dissolution of chitosan was speeded up. Then, the solution was stirred for a further 24 hours without heating until achieving total dissolving of chitosan. Next day, the pH was adjusted to 3.6 by using concentrated CH_3COOH ; distilled water was added in order to achieve final $w = 1 \%$ solution.

Preparation of Sodium Tripolyphosphate Solution

0.20 g of sodium tripolyphosphate (TPP) was dissolved in distilled water and was quantitatively transferred into 100 mL volumetric flask. Distilled water was then added to achieve final volume of 100 mL ($w = 0.2 \%$).

Preparation of Chitosan Nanoparticles

To prepare dispersion of chitosan nanoparticles ionic gelation procedure was used. A 100 mL of TPP solution ($w = 0.2 \%$) was slowly added to 100 mL of chitosan ($w = 1 \%$) until spontaneously forming dispersion of chitosan nanoparticles. They have been analyzed in terms of the size, polydispersity index (PDI) and the zeta potential (ZP) value. Mentioned methods are discussed in literature (Ristić et al., 2015).

Sorption of Zn and Cu ions in the Dispersion of Chitosan Nanoparticles

50 mL of chitosan nanoparticles dispersion was individually set to pH = 4, 5 and 6, respectively, by concentrated CH₃COOH or 1 M NaOH. Then, 1.5 mL of the solution of (Zn(CH₃COO)₂), $\gamma = 1$ g/L into first dispersion was added, into second 1.5 mL of the solution (CuSO₄x5H₂O) with $\gamma = 1$ g/L, and into the third 1.5 mL of the mixture of (Zn(CH₃COO)₂) and (CuSO₄x5H₂O) solution (1:1 volume ratio). After 1 hour of stirring of all chitosan nanoparticle dispersions, they were centrifuged (Centrifuge Centric 322A) for 20 min at 2000/min. Zn and Cu ions in supernatant were determined.

Compost leachate

Composting leachate was delivered by the firm, Kogal s.p. Composting Kogal, which annually in average processes 65.000 ton of biodegradable waste forming compost, and also 24 m³ of compost leachate per day.

Preparation of Solutions with the Compost Leachate

The compost leachate sample was analyzed by monitoring its chemical parameters. After leachate being treated with nanoparticles (prepared as described above) at pH = 6 (found as optimal at modelling solutions), it was centrifuged and afterwards the supernatant was determined regarding metal content. For the supernatant, pH, turbidity, κ and phosphorus content were analyzed. Potential use of the supernatant was also tested, so the tests of garden cress germination, supported by evaluation of phosphorus content were performed as well. Germination and initial growth of the roots were finally evaluated.

Analytical Methods

pH value was measured electrometrically using pH meter WTW pH 538 (SIST ISO 10523). Conductivity was determined electrometrically using Conductometer Iskra MA 5966 (SIST ISO 11625). Chemical Oxygen Demand was determined volumetrically following standard method (SIST ISO 6060) with digestion using termoreactor Lovibond ET 108 and Ammonium sulphate titration. Turbidity was determined using turbidimeter HACH 2100 (ISO 7027). Metal (Zn, Cu, Cd, Ni, Pb, Fe) content was determined with atomic absorption spectroscopy on Varian AA240FS (ISO 8288) after acid digestion using CEM MarsXpress 230/60 (SIST ISO 11466). Dry matter was determined gravimetrically in accordance with the SIST ISO 11465 standard. Garden cress seed germination test was done as plant test by ONORM S 2023 standard. Phosphorus was determined spectrophotometrically with Perkin Elmer Lambda 25 Spectrophotometer.

Germination test

Ten seeds of garden cress were placed onto filter paper in a petri dish and poured with 5 mL of the extract. For control, distilled water, instead of the compost leachate, was used. For the control and for each of combination three replicates were performed. Petri dishes were left at constant room temperature for 48 hours. After this time, number of germinated seeds was determined and the length of radicle was measured. The mean value was calculated together with the index of germination I_g (%) according to the equation 1:

$$I_g = \frac{N_{gs} \cdot l_s}{N_{gc} \cdot l_c} \quad (1)$$

Zaštita okoliša / Environmental Protection

Where: N_{gs} - average number of the germinated seeds of the sample, I_{ls} - average length of the radicle of the sample/mm, N_{gc} - average number of germinated seeds of the control, I_{lc} - average length of the radicle of the control/mm

Results and Discussion

Results showed that the particle size of prepared nanoparticles is in the range from 21 nm to 91 nm. At the same time the polydispersity index is low (0.355) which means that within dispersion nanoparticles of different sizes are presented; zeta potential value is 59.4 clearly showing the dispersion stability.

Modelling Solution

Model solution for Zn^{2+} and Cu^{2+} as well as their mixture were prepared and the influence of chemical conditions regarding the chelation efficiency was studied. It has been found that Zn^{2+} was totally removed below 0.1 mg/L by the optimal concentration 3 g/L of chitosan nanoparticles at pH = 6. With decreasing pH value, the decrease in Zn^{2+} concentration was observed: up to 80 % at pH = 4 and up to 86 % at pH = 5. Cu^{2+} was totally removed at all pH regardless of chosen chitosan dose. When mixture of both ions were analysed at pH = 6, similar results as with individual solutions were achieved. The optimal chemical conditions (pH=6) were transferred into real life conditions, i.e. for compost leachate treatment. It is known from the literature, that chitosan shows better chelating ability with increasing pH due to deprotonated NH_2 . This is in accordance with chitosan pK determined at 6.3 (Ristić et al., 2015). Consequently, best removal results with both metals were achieved at pH = 6.

Compost Leachate

In the composting process we are faced with excess of compost leachate produced as waste water. This water is highly polluted with organic substances and certain metals, so water should not be poured either in the environment, or into the nearby municipal sewage treatment plant. National Decree on the emission of substances and heat when discharging waste water into waters and the public sewage system (Decree, 2012) provides reduction of environmental pollution due to discharges and emissions of heat emitted in the discharge of municipal and industrial waste water as well as their mixtures. Table 1 shows the legal limited values of waste water discharge and analyzed values of a compost leachate sample. Most parameters are much higher than those required by the Decree. The compost leachate had lower pH as permitted to discharge into sewerage.

In the case of the COD measurements high value of the compost leachate is seen, amounted to 68 800 mg/L O_2 . The prescribed limit for waste water discharges into public sewerage is 120 mg/L; the measured value is 573 times greater. Deviations occur also in the case of metal content. Analytical values indicate that the content of Zn^{2+} in compost water is 20.0 mg/L, which means 10 times more of Zn^{2+} if compared to the prescribed limit value. Also, the value of Cu^{2+} is two times greater than the limit value. Significantly diverges also the parameter of turbidity with NTU of 55.1.

Parameter of turbidity is not prescribed in legislation of the waste water, but it is interesting parameter in the sense of drinking water quality that is prescribed by the legislation. The average turbidity of the drinking water in water supply systems usually ranges from 0.8 to 1.0 NTU.

Compost leachate is usually very cloudy, so certain dilution was made before performing measurements. Concentrations of the metals such as Pb^{2+} and Cd^{2+} were below the limited values.

Table 1. Legal limited values (Decree, 2012) and analytical values for the content of individual parameters

Parameter	Unit	Limited (permitted) values	Analytical value of fresh compost leachate
pH	/	6.5 – 9.5	5.1
COD	mg/L O ₂	120.0	68 800
Turbidity	NTU	/	55.1
Conductivity, κ	mS/cm	/	4.0
γZn^{2+}	mg/L	2.0	20
γCu^{2+}	mg/L	0.5	1.0
γPb^{2+}	mg/L	0.5	<0.1
γCd^{2+}	mg/L	0.025	< 0.1
γNi^{2+}	mg/L	0.5	1.3

Results of the Metal Content in the Supernatant

It is known that in the early stage of composting, the compost leachate is highly toxic, but later toxicity is reduced (EPA, 1994). The content of heavy metals is of a particular concern with the supernatant intended for fertilization or plant nutrition on agricultural land. Table 2 presents the content of metals in samples of supernatant of compost leachate before and after the treatment of chitosan nanoparticles. In accordance to results collected in Tab. 2 it can be seen that the values for the metals' content within supernatant of compost leachate (see Tab. 1) are still too high. Concentrations of the metals such as Pb^{2+} and Cd^{2+} remained below the limited values. Supernatant of chitosan treated compost leachate is alarmingly high in Ni^{2+} , which is the reason that also after chitosan treatment the compost leachate is not to be discharged neither in natural waters neither into public sewer. Ni^{2+} exceeds the limit value 2 times. Exception is seen with the content of Zn^{2+} , where sample did not exceed the maximum limit of 2.0 mg/L.

Table 2. The content parameters in supernatant

Parameter	Compost leachate	Compost leachate after chitosan treatment nanoparticles
pH	5.1	6.0
COD (mg/L O ₂)	68 800	51 600
Turbidity (NTU)	551	480
Conductivity (mS/cm)	4.0	3.9
Cu^{2+} (mg/L)	1.0	< 0.1
Zn^{2+} (mg/L)	20.0	0.3
Pb^{2+} (mg/L)	< 0.1	< 0.1
Cd^{2+} (mg/L)	< 0.1	< 0.1
Ni^{2+} (mg/L)	1.3	1.0

Zaštita okoliša / Environmental Protection

Results of the Nutrient Content in Supernatant

A point of interest is shown with the high content of important plant nutrient K^+ . The concentration was determined at 128.5 mg/L, and after treatment it decreased only for 2 %. Given the fact that the treated compost leachate cannot be discharged into sewerage, it might be used as hydroponic solution (plant nutrition) in agronomy. The content of phosphorus (P) in supernatant was measured as well. Prescribed limit value for entire P for directly or indirectly release into water is 1.0 to 2.0 mg/L. The content of P in the supernatant of the non-treated compost leachate is 62.2 mg/L, which is 31 times higher if compared to the national Regulation, whilst in the chitosan treated compost leachate supernatant 10 mg/L P content is only 5 times higher than limited value of 2 mg/L.

Germination Tests in the Supernatant of Compost Leachate

As a test plant a garden cress (*Lepidium sativum* L.) was used. Germination and initial growth of roots were evaluated in the supernatant, and compared with results of germination in distilled water. Germination test was performed by supernatant dilution of 10, and of 40 times. With the first dilution none of garden cress samples germinated due to high κ (above 3.0 mS/cm). By performing test κ slightly increased, which is a sign of organic compounds mineralization. By exceeding κ up to 3.0 mS/cm, then a concentration of a salt could negatively impact germination and covers the real influence of phytotoxic intermediate products on combustion. Also, with dilution of 40 x germination was not successful, since solution in which the seeds of garden cress took place, contained too high concentrations of a salt (seeds had a black-root tips). Only when, untreated and treated, compost leachate was 100 times diluted the garden cress germinated. Maturity by using germination test at dilution of 100 times is shown in Fig. 1.

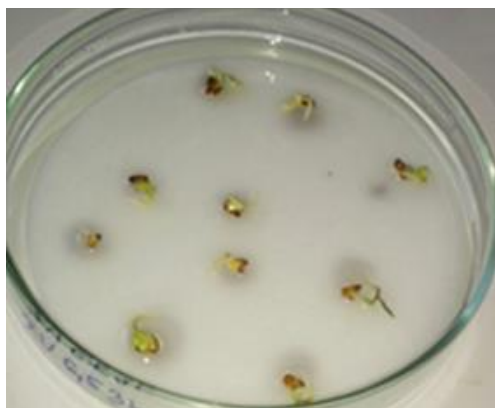

Fig. 1. Maturity by using germination test at dilution of 100 times

Results of germination tests have shown that the values of the germinating index ranging in-between 40 % and 60 % (10 times to 40 times dilution), respectively, compared to the control of deionized water. This was the base to rank treated samples according to the usability in agriculture as potential hydroponic solutions.

Any treatments that are above the limit of 50 % can be used as fertilizer in agriculture when applied into the soil, but if we want to grow plants directly in the hydroponic solution (water with soluble ions where plant roots are growing), the germination index must be near 100 % (no phyto-toxicity expressed). In our case, the obtained chitosan treated supernatant of compost leachate, even when 100-times diluted with deionized water, was still slightly phytotoxic and thus not suitable as a hydroponic solution. This dilution also substantially diluted plant nutrients (e.g. potassium) so also the nutritional value for plants would be too low.

Conclusions

Treatment of all modelling solutions by chitosan nanoparticle dispersions showed that total removal of Zn and Cu (100 % of reduction) was achieved at pH = 6. Thus, real compost leachate was treated at those optimal conditions. The treatment of compost leachate by chitosan nanoparticles effectively removes some heavy metals, such as Cu and Zn from compost leachate. The treatment however provides supernatant that can potentially be used as irrigation water in agriculture with some nutritional effect as potassium addition. Supernatant cannot be used as hydroponic solution i.e. direct plant nutrient solution even if 100-times diluted with pure water. With such high dilution also potential beneficial nutrients (like K and P) are too much diluted for having any beneficial effect on plants.

Acknowledgement: The research work was produced within the framework of the program P2-0118 Textile Chemistry, financially supported by Slovenian Research Agency.

References

- Bassi, R., Prasher, S.O., Simpson, B.K. (2000): Removal of Selected Metal Ions from Aqueous Solutions Using Chitosan Flakes, *Sep. Sci. Technol.* 35 (4), 547-560.
- Decree (2012): Decree on the emission of substances and heat when discharging waste water into waters and the public sewage system. (2012). Official Gazette of Republic of Slovenia 64, <http://www.uradni-list.si/1/content?id=109650#!/Uredba-o-emisijisnovi-in-toplote-pri-odvajanju-odpadnih-voda-v-vode-in-javno-kanalizacijo> (9. 20. 2017).
- EPA (1994): Composting Yard Trimmings and Municipal Solid Waste. <https://www.scribd.com/document/36214465/Composting-Yard-Trimmmings-Municipal-Wasteburnalt1> (9.2.2017.)
- Ristić, T., Lasič, S., Kosalec, I., Bračić, M., Fras Zemljič, L. (2015): The effect of chitosan nanoparticles onto Lactobacillus cells, *React. Funct. Polym.* 97, 56-62.
- Romero, C. et al. Ramos, P., Costa, C., Márquez, M.C. (2013): Raw and digested municipal waste compost leachate as potential fertilizer, comparison with a commercial fertilizer, *J. Cle. Prod.* 59, 73-78.
- Savage, A.J., Tyrrel, S.F. (2005): Compost leachate bioremediation using waste materials as biofiltration media, *Bioresour. Technol.*, 96, 557-564.
- Strnad, S., Šauperl, O., Fras, L., Jazbec, A. (2007): Hitozan – vsestransko uporaben biopolimer, www.tekstilec.si/wp./Hitozan-vsestransko-uporaben-biopolimer.pdf.
- Tyrrel, S.F., Seymour, I., Harris, J.A. (2008): Bioremediation of leachate from a green waste composting facility using waste-derived filter media, *Bioresour. Technol.* 99 (16), 7657-7664.

Susret mladih kemičara
Meeting of Young Chemists

Sadržaj vitamina C u malinama s područja općine Žepče

Tomislav Jozinović, Maja Stojanović*

*Katolički školski centar "Don Bosco" Žepče, Opća gimnazija, Stjepana Radića bb,
72230 Žepče, Bosna i Hercegovina*

**Dopisni autor: majastojanovic1807@gmail.com*

Sažetak

Općina Žepče je jedno od najjačih područja u Bosni i Hercegovini po ukupnoj količini proizvedene i otkupljene maline. Biološka vrijednost namirnica često se određuje preko sadržaja vitamina u namirnici. Vitamini su esencijalni mikronutrijenti u prehrani ljudi i njihov nedostatak dovodi do razvoja različitih bolesti kod ljudi. Vitamin C ima važne funkcije u ljudskom organizmu, među kojima se osobito ističe poticanje rada metabolizma, održavanje zdravlja krvnih žila, stimulacija rada imunološkog sustava itd. Maline osim vitamina sadrže i biološki aktivne komponente (fitokemikalije) koji iskazuju pozitivan učinak na zdravlje ljudi. Znanstvenici navode da interakcijom fitokemikalija s drugim fiziološkim antioksidansima poput vitamina C i E nastaje sinergistički učinak antioksidativnog djelovanja. Zbog male energetske vrijednosti i velike biološke važnosti, te ugodne arome i okusa, maline imaju široku primjenu u ljudskoj prehrani i posjeduju određena ljekovita svojstva.

Cilj ovog rada je određivanje kvantitativnog sadržaja vitamina C u različitim uzorcima pripremljenim od svježih i konzerviranih malina, proizvedenih na obiteljskim poljoprivrednim gazdinstvima s područja općine Žepče pomoću volumetrijske metode - jod titracije. U radu je korištena volumetrijska metoda - jod titracija za određivanje sadržaja vitamina C. Dobiveni podaci su ukazivali na značajne razlike u sadržaju vitamina C u različitim uzorcima malina.

Ključne riječi: malina, vitamin C, općina Žepče, jod titracija

Uvod

Općina Žepče smještena je u središnjem dijelu Bosne i Hercegovine. Prostire se na površinu od 282 km² i šesta je po veličini općina u Zeničko-dobojskoj županiji. Klima je umjereno kontinentalna s umjereno ostrim zimama i toplim ljetima što izuzetno doprinosi razvoju poljoprivrednih djelatnosti i kultura. Od ukupne površine općine, 70% čine ruralna područja s uglavnom zasađenim malinama i drugim poljoprivrednim kulturama. Sektor jagodičastog i bobičastog voća predstavlja izraziti potencijal za rast i razvoj općine Žepče, a osobito njezinih ruralni područja. U ovom sektoru najveći dio zauzima uzgoj maline. Malina je u općini Žepče postala vodeća voćna vrsta upravo zbog plodna tla na području općine, ali i jednostavne vodoopskrbe zbog blizine rijeke Bosne. Sorte malina koje su najviše zastupljene su Miker i Wilamette, a u zadnje vrijeme se podižu novi zasadi sorte Tulameen i jednogodišnje sorte Polka. Malina pripada skupini bobičastog voća koje je izrazito bogato polifenolnim spojevima koji imaju antioksidacijsku ulogu u organizmu. Antioksidansi štite tkiva od oksidacijskog stresa i na taj način smanjuju rizik od razvitka tumora i srčanih bolesti.

Maline imaju karakterističan kemijski sastav, imaju vrlo malu energetska vrijednost i izrazito su bogate vlaknima. Od mikronutrijenata sadrže brojne vitamine od kojih najveći udio otpada na vitamin C (26,2 mg na 100 maline). Od minerala osobito su bogate kalijem, kalcijem, folnom i pantotenskom kiselinom. Vitamin C (askorbinska kiselina, C - vitaminska kiselina) je jedan od najispitivanijih i najviše opisanih vitamina i prvi sintetski dobiveni vitamin. Prisutan je u svježem voću i unutar našega organizma obavlja nekoliko različitih funkcija. Najvažniji biološki značaj vitamina C je: poticanje rada metabolizma, održavanje zdravlja krvnih žila, održavanje zdravlja zubi, kostiju i hrskavičnog tkiva, stimulacija imuniteta tijela, apsorpcija i dostupnost željeza u tijelu, razgradnja kolesterola i slično. Vitamin C također iskazuje antioksidacijsko djelovanje i brojni znanstveni radovi ukazuju na povezanost vitamina C i polifenolnih spojeva u antioksidacijskoj sposobnosti malina. Nedovoljno unošenje vitamina C u organizam može izazvati različite poremećaje unutar samoga organizma. Bez štetnih posljedica, može se unositi čak 1000 mg vitamina C, a prema nekim znanstvenim radovima kod doza većih od 250 mg samo mali dio se zadržava u tijelu, a većina izlučuje mokraćom. S obzirom na ukazanu povezanost vitamina C i malina, sami cilj ovoga našega rada jest određivanje kvantitativnog sadržaja vitamina C u različitim uzorcima pripremljenim od svježih i konzerviranih malina s područja općine Žepče.

Malina i jagodičasto voće kao potencijal razvoja općine Žepče

Podsektor jagodičastog i bobičastog voća bilježi kontinuirani rast na području općine Žepče, gdje se trenutno (2016) nalazi 332,5 ha zasada maline, te se godišnje proizvede preko 1.000 t maline u obliku sirovine. Ovaj sektor predstavlja značajnu podršku za obiteljsko poljoprivredna gospodarstva na kojima je u većinom i temeljena poljoprivredna proizvodnja na području općine Žepče (registrirano 670 OPG-a). Pored maline značajno je spomenuti uzgoj kupine, borovnice i jagode na otvorenom. Ukupna površina pod jagodičastim voćem na području općine Žepče iznosi 376,6 ha, sa 2161 proizvođačem. Područje općine Žepče je uz regiju Srebrenicu-Bratunac, najjače područje u Bosni i Hercegovini po ukupnoj količini proizvedene i otkupljene maline. Uzgajivači jagodičastog i bobičastog voća su najvećim dijelom okupljeni u zadruge (PZ „Poljar“ i PZ „Žepački Rolend“) i udruženja (UP „Proizvođači maline kooperanti Željezno Polje-Žepče“; Udruženje invalidi poljoprivrednici „Patrioti“; Udruženje „Žitoplod“ Žepče; UP „EkoAgar“) koja djeluju na području općine Žepče. Vodeće sorte maline koje se uzgajaju su Willamete, Polka, Meeker i Tulameen. U 2016. godini na području općine Žepče je proizvedeno i otkupljeno 1373 t maline. Na području općine Žepče instalirani su skladišni i rashladni kapaciteti, trenutno postoje četiri hladnjače za skladištenje svježe maline. Zadruga i udruženja u suradnji sa značajnim otkupljivačima, većinu proizvedene maline prodaju kao svježu što implicira malu količinu prerade malina u proizvode dodane vrijednosti (sok, džem, vino i sl.).

Malina (lat. Rubus idaeus)

Malina je višegodišnja biljka iz skupine bobičastog voća. Grm ove biljke može narasti i do 250 cm u visinu. Listovi su složeni od 3 do 7 listića i perasto sastavljeni. Plodovi su zbirni, najčešće crvene boje i jako su ukusni za jesti, a beru se posve zreli. Sjemenke su svijetlosmeđe boje, mrežasto naborane, a najčešće ih raspršuju ptice.

Maline su rasprostranjene po Europi i sjevernoj Aziji. Rastu na rubovima šuma gdje je veća vlažnost zraka. Biljka ima ljekovita svojstva i koristi se za pravljenje različitih proizvoda. Rastu od sredine ljeta do sredine jeseni, a cvatu od svibnja do lipnja.

Susret mladih kemičara / Meeting of Young Chemists

Botanička klasifikacija maline (USDA, 2015.):

Carstvo: *Plantae*

Odjeljak: *Spermatophyta (sjemene)*

Pododjeljak: *Angiosperme (golosjemenjače)*

Divizija: *Magnoliophyta (cjetnice)*

Razred: *Magnoliopsida (dikotiledoni)*

Red: *Rosales*

Porodica: *Rosaceae (ruža)*

Potporodica: *Rosoideae*

Rod: *Rubus L.*

Vrsta: *Rubus idaeus L. (Američka crvena malina)*

Još od doba starih Grka, malina je bila poznata, te njezino ime potječe od imena planine Ida na Kreti. Postoji jedan grčki mit prema kojem je malina spasila život Zeusu u djetinjstvu. Tadašnji vrhovni bog Kron, Zeusov otac, htio ga je ubiti a njegova majka ga je sakrila iza grmlja maline. Prema tome mitu Zeus je postao vrhovni bog. Rimljani su proširili uzgoj malina po Europi, a već u srednjem vijeku se malina počinje koristiti u medicinske svrhe i kao bojilo. Do danas je poznato preko 195 vrsta malina, među kojima su najvažnije Europska malina (Europa i Azija), Crvena malina (Sjeverna Amerika i Azija), Crna i Ljubičasta malina koje su rasprostranjene na području Sjeverne Amerike.



Slika 1. Listovi i plod maline
Fig. 1. The leaves and fruit of raspberry

Kemijski sastav i nutritivna svojstva maline

Brojne znanstvene studije su pokazale da bobičasto voće zahvaljujući velikom sadržaju antioksidanasa, vitamina, minerala, vlakana i drugih značajnih fiziološki tvari povoljno utječe na očuvanje zdravlja. Kemijski sastav bobica ima veliki utjecaj na njihov izgled, boju, miris i okus. Ova vrsta voća ima sladak okus, voćni miris, te mekanu i sočnu konzistenciju. Kemijski sastav ploda je uvelike pod utjecajem okolišnih čimbenika, zrelosti i uvjetima skladištenja (Bobinaite i sur., 2012.). Kao i većina voća, malina sadrži najviše vode koje ima 85,75 %, zatim šećera 4,42g. Vrijedan je izvor prehrambenih vlakana kojih sadrži 6,5g /100g maline (USDA, 2015).

Tablica 1. Kemijski sastav u 100 g svježeg ploda malina (USDA, 2015)
Table 1. The chemical composition in 100 grams of fresh raspberry fruit (USDA, 2015)

Sastav	Jedinica	Vrijednost u 100g
Voda	g	85,75
Energija	kcal	52,00
Proteini	g	1,20
Ukupni lipidi	g	0,65
Ugljikohidrati	g	11,94
Vlakno	g	6,50
Šećeri	g	4,42

Maline su dobar izvor vitamina, pogotovo vitamina C (100g malina može osigurati 50% dnevnog unosa vitamina C) (Haffner i sur., 2002., Pantelidis i sur., 2007). Prosječan sastav vitamina svježeg ploda maline prikazan je u tablici 2.

Tablica 2. Sastav vitamina svježeg ploda maline (USDA, 2015)
Table 2. The vitamin content of fresh raspberry fruit (USDA,2015)

Vitamini	Jedinica	Vrijednost u 100g
Vitamin C	mg	26,20
Tiamin	mg	0,03
Riboflavin	mg	0,04
Niacin	mg	0,60
Vitamin B6	mg	0,06
Folat, DFE	µg	21,00
Vitamin B12	µg	0,00
Vitamin A, RAE	µg	2,00
Vitamin A, IU	IU	33,00
Vitamin E	mg	0,87
Vitamin D (D2+D3)	µg	0,00
Vitamin D	IU	0,00
Vitamin K	µg	7,80

Prema USDA podacima malina je najbogatija kalijem, zatim kalcijem, magnezijem i željezom (tablica 3).

Tablica 3. Mineralni sastav svježeg ploda maline
Table 3. The mineral composition of fresh raspberry fruit

Minerali	Jedinica	Vrijednost u 100g
Kalcij, Ca	mg	25,00
Željezo, Fe	mg	0,69
Magnezij, Mg	mg	22,00
Fosfor, P	mg	29,00
Kalij, K	mg	151,00
Natrij, Na	mg	1,00

Susret mladih kemičara / Meeting of Young Chemists

Bobičasto voće se konzumira zbog svoje atraktivne boje i posebnog okusa, a smatra se jednim od najbogatijih izvora antioksidanasa (Manganaris i sur., 2013.). Antioksidansi imaju važnu ulogu u zaštiti zdravlja. Znanstveni dokazi pokazuju da antioksidansi smanjuju rizik od bolesti poput tumora i srčanih bolesti (Parakash i sur., 2011), te ih je poželjno unositi hranom. Maline su odličan izvor antioksidanasa među kojima se osobito ističu polifenolni spojevi, koji se prema osnovnoj kemijskoj strukturi dijele na flavonoide i fenolne kiseline.

Polifenolni spojevi malina značajno doprinose antioksidacijskom kapacitetu što je u organizmu izraženo kao antiupalno, antialergijsko i antikancerogeno djelovanje (Jakobek i sur., 2008). Karakterističan sadržaj fenolnih spojeva, elagitanina i antocijana, razlikuje maline od ostalog bobičastog voća. Ustanovljeno je da je antioksidativna aktivnost maline za 50% veća od antioksidativne aktivnosti jagode, 10 puta veća od rajčice i tri puta veća od kivija (Beekwilder i sur., 2005.).

Sorte malina na području općine Žepče

U malinjacima na prostoru općine Žepče se uzgajaju četiri sorte malina: Meeker, Willamette, Tulameen i Polka. Sorta maline *Meeker* razvijena je još 1967 godine. Plodovi su srednje veličine, srednje crveni, čvrsti i s dobrim ukusom. Zri sredinom ljeta, plodovi se lako odvajaju i izrazito je pogodna za strojno branje pa se iz toga razloga najviše uzgaja u SAD-u gdje zauzima više od 60 % ukupne proizvodnje maline. Osjetljiva je na neke viruse koji se prenose polenom i srednje je otporna na truljenje korijena.



Slika 2. Malina, sorta Meeker
Fig. 2. The raspberry, Meeker variety

Sorta maline *Willamette* rađa krupne tamno crvene i ukusne plodove od sredine do kasnog ljeta. Stabljika je dvogodišnja i ova malina najbolje uspijeva na punom suncu s dosta vode i dobrim đubrenjem u vrijeme cvjetanja. Willamete su trnjaste maline dok ima i vrsta bez trnja. Bijeli cvjetovi pojavljuju se od travnja do lipnja, a plodovi su crveni, ponekad i žuti. Vezivanje u žicu je neophodno.



Slika 3. Malina, sorta Willamette
Fig. 3. The raspberry, Willamette variety

Sorta maline *Tulamen* je sorta razvijena 1989 godine. Plodovi su vrlo krupni i dugi, srednje crveni, sjajni i čvrsti. Počinje zrijeti kad i Meeker, ali ima dužu sezonu berbe, najduže vrijeme zrenja od svih ljetnih malina (oko 50 dana). Odlična je za tržište svježe maline zbog svog ukusa i veličine. Srednje otporna na truljenje korijena te otporna na mozaik viruse maline.



Slika 4. Malina, sorta Tulameen
Fig. 4. The raspberry, Tulameen variety

Sorta maline *Polka* je stalno rađajuća sorta malina. Poznata je i kao jesenja malina jer joj je vrijeme sazrijevanja produženo pa se berba odvija od lipnja pa sve do zimskih mjeseci. Plodovi ove sorte su srednje krupni, čvrsti i tamnocrvene boje. Pošto se beru na 2 do 3 dana, a pun rod se dostiže u drugoj godini, prinos po hektaru može biti i do 12 tona.



Slika 5. Malina, sorta Polka
Fig. 5. The raspberry, Polka variety

Susret mladih kemičara / Meeting of Young Chemists

Vitamini

Vitamini su biološki regulatori kemijskih reakcija mijene tvari u organizmu. Djeluju u malim količinama u sintezi enzima i tkiva, štite tijelo od zaraze i dr. Ljudski organizam u pravilu ne sintetizira sve vitamine pa ih moramo uzimati hranom. Vitamini su važni „sudionici“ brojnih metaboličkih reakcija, npr. vitamini B-kompleksa, vitamini C i D. Dugo vremena vladalo je mišljenje da višak vitamina, tj. *hipervitaminoze* ne štete organizmu, jer se višak oslobađa bez posljedica iz tijela. Danas, naprotiv, znamo da višak većine vitamina štodi različitim fiziološkim sustavima u tijelu te stoga treba izbjegavati pretjerano uzimanje vitamina bez prethodnog utvrđivanja vitaminskog statusa u tijelu.

Vitamin C

Vitamin C ili askorbinska kiselina ($C_6H_8O_6$) je vitamin topljiv u vodi, a prisutan je u svježem voću i povrću. On je jedan od najviše ispitivanih i najviše opisanih vitamina, te prvi sintetski dobiven vitamina (slika 6). Vitamin C je bezbojna kristalna tvar, molarne mase 176 g/mol i gustoće 1.694 g/cm³ i ima kisel okus. Dobro je topljiv u vodi i metanolu, a oko pet puta manje topljiv u etanolu. Većina životinja sintetizira vlastiti vitamin C, dok je čovjek tijekom evolucije izgubio tu mogućnost (negativna mutacija), te je ovisan o uzimanju tog vitamina u hrani odnosno vitamin C je za čovjeka esencijalni vitamin.

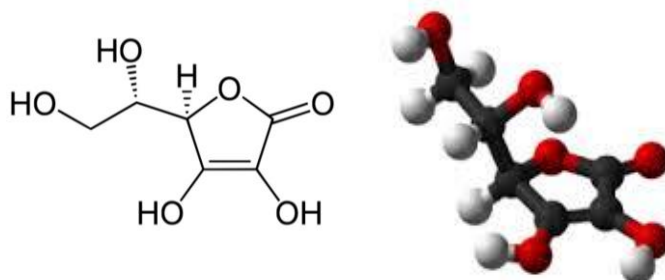

Slika 6. Strukturne formule vitamina C
Fig. 6. Structural formulae of vitamin C

Biološki je aktivna tvar, ali gubi biološku aktivnost već pri 60°C. Uništava se kuhanjem, oksidacijom i djelovanjem baza, ali je otporan na zamrzavanje. U prirodi se može naći samo L-oblik askorbinske kiseline koji je biološki aktivan. Askorbinska kiselina se relativno lako oksidira s kisikom iz zraka, a osobito u prisutnosti iona teških metala (željeza ili bakra). U odsutnosti kisika askorbinska kiselina može izdržati zagrijavanje i do 100 °C.

Biološka važnost vitamina C

Vitamin C je jedan od glavnih antioksidansa, a ujedno i najjači antioksidans među vitaminima topljivim u vodi. U živim organizmima djeluje kao antioksidans i štiti organizam od oksidativnog stresa. Kao kofaktor sudjeluje u najmanje šest enzimatskih reakcija, među kojima je sinteza kolagena, čija se disfunkcionalnost odražava simptomima karakterističnim za skorbut. Vrlo je važno znati da povećava otpornost organizma prema virusnim i bakterijskim infekcijama, uključujući i alergije te je učinkovit kod liječenja bolesti dišnih putova i još niz drugih bolesti.

Vitamin C funkcionira kao koenzim u brojnim reakcijama hidroksiliranja i amidiranja. Sa svojim dehidro-oblikom reverzibilni je oksido-redukcijski sustav, koji ima važnu ulogu u oksido-redukativnim procesima i u staničnom disanju. Ima veliku ulogu u stvaranju kolagena značajnog za razvoj i regeneraciju tkiva, krvnih žila, kostiju i zuba, a sudjeluje i kao reducens u brojnim biološkim procesima.

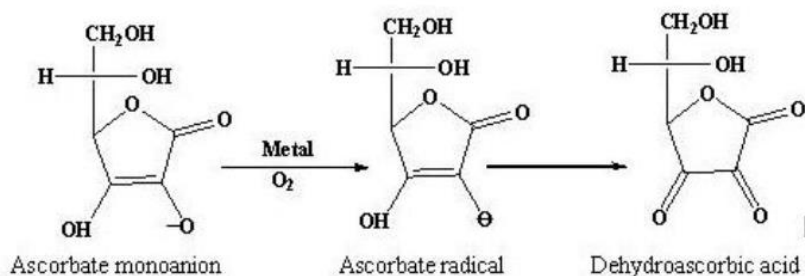

Slika 7. Reakcija oksidacije vitamina C u nepovoljnim uvjetima – prisutnost kisika iz zraka i metala
Fig. 7. The oxidation reaction of vitamin C under unfavorable conditions- the presence of atmospheric oxygen and metals

Dostupnost i preporučene doze vitamina C

Najbogatiji izvor vitamina C je raznoliko voće i povrće. To su prije svega agrumi (naranče, mandarine, limun), šipak, višnja, crni ribiz, lisnato povrće, kupus, krumpir, jabuke, paprike i dr. U mlijeku i životinskim tkivima (npr. jetra) nalazi se znatno manja količina vitamina C. Mnogi znanstvenici preporučuju upotrebu velikih doza vitamina C preventivno za zdraviji život. Nobelovac L. Pauling je preporučio da dnevni unos vitamina C mora biti čak 1-2 g na dan. Istraživanja u SAD-u pokazala su da 60% odraslih muškaraca i 53% odraslih žena ima manji unos vitamina C od procijenjenog prosječno potrebnog unosa. Preporučena dnevna doza (RDA) za vitamin C koja se primjenjuje u Republici Hrvatskoj (Tablica 2.) iznosi 60 mg u prosjeku (prema Pravilniku dodacima prehrani, NN 2008). Američke preporuke navode dozu od 75 mg za žene nepušačice i 90 mg za muškarce nepušače. RDA za pušače iznose 110 mg dnevno za žene i 125 mg dnevno za muškarce. Maksimalni dnevni dopušteni unos vitamina C prema hrvatskom Pravilniku iznosi 350 mg, dok je američki časopis *Food and Nutrition Board* donio odluku kako je maksimalni dnevni dopušteni unos 2000 mg.

Kvantitativno određivanje vitamina C pomoću volumetrije

Volumetrijske metode su analitičke metode zasnovane na mjerenju volumena dodanog reagensa. Određivanja se izvode na način da se otopini tvari koja se određuje dodaje standardna otopina reagensa (poznate koncentracije) sve dok određivana tvar potpuno ne reagira s reagensom. Opisan postupak se naziva titracija. Za provedbu titracije potrebno je, osim uzorka i standardne otopine, imati i indikator koji će pokazati točku završetka titracije, tj. koji će dati neku vidljivu promjenu u otopini, u trenutku kad je reakcija završena.

Susret mladih kemičara / Meeting of Young Chemists

Tablica 4. Preporučene dnevne doze unosa vitamina C za različite dobne i spolne skupine (USDA, 2015)

Table 4. Recommended Dietary Allowances of vitamin C for various age and gender groups

Životno razdoblje	Dob	Muškarci (mg/dan)	Žene (mg/dan)
Dojenčad	0-6 mjeseci	40	40
Dojenčad	7-12 mjeseci	50	50
Djeca	1-3 godina	15	15
Djeca	4-8 godina	25	25
Djeca	9-13 godina	45	45
Adolescenti	14-18 godina	75	65
Zrela dob	19 godina i više	90	75
Pušači	19 godina i više	125	110
Trudnoća	18 godina i manje	–	80
Trudnoća	19 godina i više	–	85
Laktacija	18 godina i manje	–	115
Laktacija	19 godina i više	–	120

Jod titracija

U literaturi su opisane različite metode određivanja udjela L-askorbinske kiseline, dehidroksiaskorbinske kiseline i njihovog ukupnog sadržaja (vitamina C), a zasnivaju se na reverzibilnoj sposobnosti sustava (Slika 8.).

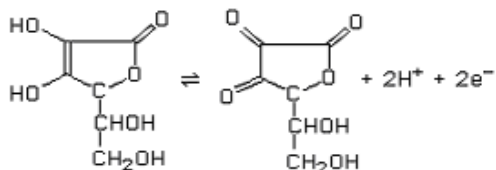

Slika 8. Prikaz pretvorbe L – askorbinska kiselina ↔ Dehidroksiaskorbinska kiselina

Fig. 8. The conversion of L-ascorbic acid into Dehydroascorbic acid

Jedna od volumetrijskih metoda određivanja vitamina C je jod titracija. Nepoznata količina vitamina C (askorbinske kiseline) može se odrediti pomoću standardne otopine joda. Kada askorbinska kiselina dođe u dodir s jodom, kemijskom reakcijom nastaje dehidroaskorbinska kiselinu i jodid (Slika 9.).

Otopina škroba (indikator) se dodaje u otopinu vitamina C za prikaz kada je kemijska reakcija završena. Dokle god postoji još vitamina C u otopini, jod će reagirati s njim i postati jodid. Kada sav vitamin C izreagira i postane dehidroaskorbinska kiselina, jod će reagirati s škrobom i stvoriti tamno plavu boju, signalizirajući da je reakcija završena.

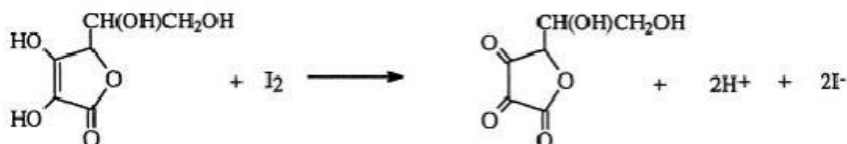

Slika 9. Reakcija askorbinske kiseline i joda kojom nastaje dehidroaskorbinska kiselina i jodid
Fig. 9. The ascorbic acid and iodine reaction resulted with dehydroascorbic acid and iodide

Materijali i metoda

Materijal

Za rad u školskom laboratoriju korišten je slijedeći materijal: plamenik, tronožac, bireta, kleme, stativ, Erlenmayerove tikvice 250 mL, staklene čaše 100 mL i 500mL, odmjerne tikvice 250mL, stakleni štapić, stakleni lijevak, filter papir, cjedilo, menzure 100mL i 500mL, tamne boce za čuvanje otopina, nož, štapni mikser sa pripadajućom visokom posudom za usitnjavanje malina, pladnjevi, tanjurići za vaganje, vaga, bijeli papir kao podloga ispod čaša, destilirana voda, 1% otopina škroba, standardna otopina askorbinske kiseline, otopina kalijevog jodida i jodata te uzorci svježih i konzerviranih maline s područja Žepča.

Priprema uzorka

U radu je ispitivan sadržaj vitamina C uzorcima malina sorte Meeker (Tablica 5.).

Tablica 5. Prikaz uzoraka malina korištenih u radu

Table 5. The raspberry samples used for the thesis

Naziv uzorka	Opis
Uzorak 1	Svježe maline
Uzorak 2	Maline čuvane u hladnjaku tijekom 2 dana
Uzorak 3	Maline čuvane u tamnom i mračnom prostoru tijekom 2 dana
Uzorak 4	Maline čuvane u zamrzivaču tijekom 2 mjeseca
Uzorak 5	Džem od malina

Potrebno je usitniti 100g uzorka malina sa 50mL destilirane vode štapnim mikserom u visokoj posudi. Dobivenu smjesu procijediti kroz filter papir i cjedilo u čašu. Filter papir isprati s nekoliko mL destilirane vode. Filter papir i krupne ostatke baciti, a otopinu prebaciti u menzuru te dopuniti do volumena od 100mL.

Susret mladih kemičara / Meeting of Young Chemists

Metoda rada u laboratoriju

Priprema otopina za jod titraciju

Otopina škroba: U čaši je potrebno zagrijati skoro do vrenja 50mL destilirane vode, ohladiti i otopiti 0,50 g škroba (p.a). Otopinu spremi u bocu.

Otopina jodida: U Erlenmayerovoj tikvici otopiti 5g kalijevog jodida (KI; p.a.) i 0.268g kalijevog jodata (KIO₃; p.a.) u 200mL destilirane vode. Dodati 30 mL 3M sumporne kiseline (H₂SO₄; p.a.). Preliti u menzuru od 500mL i dopuniti do konačnog volumena od 500mL. Preliti u bocu i označiti kao otopinu jodida.

Standardna otopina vitamina C: U čaši je potrebno otopiti 0.250g vitamina C u 100mL destilirane vode, zatim preli u odmjerenu tikvicu od 250mL i dopuniti do 250mL destiliranom vodom, da bi koncentracija bila 1mg/mL. Otopinu smo preli u tamnu bocu (jer je vitamin C osjetljiv na svjetlost) i označiti kao otopinu vitamina C.



Slika 10. Pripremljene otopine korištene u radu
Fig. 10. Prepared working solutions

Standardiziranje otopine za titraciju

Odmjeriti 25mL standardne otopine vitamina C u Erlenmayerovu tikvicu. Zatim dodati 10 kapljica otopine škroba. Biretu je potrebno prvo isprati s otopinom jodida, zatim ju napuniti tom istom otopinom do oznake 0 te titrirati otopinu. Titracija je završena kada pojava plavo – ljubičaste boje traje duže od 20 sekundi pri stalnom miješanju otopine (Slike 11. i 12.). Zabilježili smo volumen koji je bio potreban za titraciju te ponovili titraciju još dvaput.

Titiranje uzorka

Pipetom smo uzeli 25mL pripremljenog uzorka maline i stavili u Erlenmayerovu tikvicu, dodali 10 kapi otopine škroba i titrirali otopinom jodida do pojave ljubičaste boje. Utrošak otopine jodida pri titraciji smo zapisali. Za svaki uzorak postupak titracije je ponovljen tri puta.

Obrada podataka - računanje količine vitamina C iz uzorka

Količinu vitamina C izračunali smo prema jednadžbi :

$$V(\text{ otopine jodida za standardnu titraciju }) / 0,25\text{g vit C} = V(\text{ jodida za uzorak }) / X\text{g vit C} \\ X\text{g vit C} = V(\text{ jodida za uzorak }) \times 0,25\text{g vit C} / V(\text{ otopina jodida za standardnu titraciju })$$



Slika 11. Prikaz titracije standardne otopine vitamina C
Fig. 11. Titration of vitamin C standard solution



Slika 12. Prikaz završene titracije standardne otopine vitamina C
Fig. 12. The endpoint of titration of standard vitamin C solution

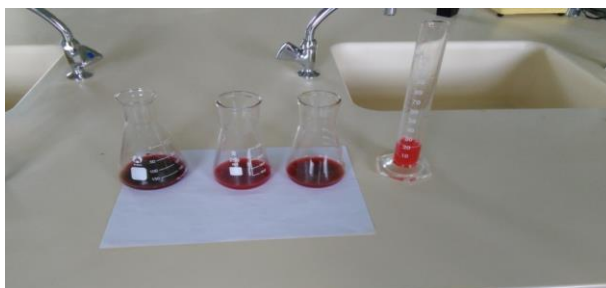

Slika 13. Prikaz titracije uzorka maline
Fig. 13. Titration of raspberry samples

Susret mladih kemičara / Meeting of Young Chemists

Tablica 6. Prikaz utrošenog volumena otopina jodida za titraciju uzoraka
Table 6. The titre volume of iodide solution used for samples titration

Uzorci	Utrošeni volumen jodida
Uzorak 1	1,8 mL
Uzorak 2	1,2 mL
Uzorak 3	1,3 mL
Uzorak 4	1,6 mL
Uzorak 5	0,5 mL

Rezultati i rasprava

Iz dobivenih rezultata vidljivo je da najveći sadržaj vitamina C imaju svježije maline. Sadržaj vitamina C najmanji je u uzorku 5. odnosno džemu od maline, što se može objasniti iz samog postupka dobivanja džema koji zahtjeva primjenu visokih temperatura kroz određeni vremenski period. S obzirom na termolabilnost i osjetljivost vitamina C, primjena visokih temperatura u postupku proizvodnje utječe na njegov gubitak u iznosu od 72 % od početnog sadržaja u svježim malinama. Uzorci 2. i 3. ne razlikuju se značajno u sadržaju vitamina C, jer ti uzorci nisu bili izloženi procesiranju i visokim temperaturama. Ovi uzorci predstavljaju maline čuvane u hladnjaku odnosno u tamnom i hladnom prostoru tijekom 2 dana što je utjecalo na gubitak vitamina C u iznosu od 33,2% odnosno 27,4 %.

Sadržaj vitamina C u 100 g uzorka

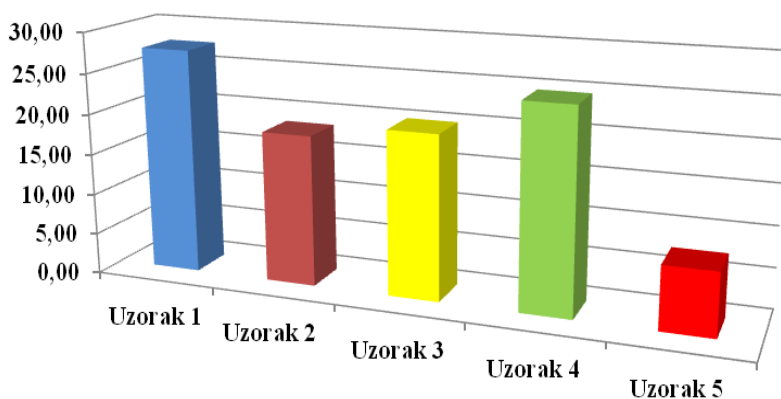

Graf 1. Prikaz sadržaja vitamina C u ispitivanim uzorcima malina
Chart 1. The vitamin C content in analyzed raspberries samples

Tablica 7. Prikaz sadržaja vitamina C u različitim uzorcima maline

Table 7. The vitamin C content in various raspberries samples

Oznaka uzoraka	Sadržaj vitamina C u 100g uzorka
Uzorak 1 - svježe maline	27,7 mg
Uzorak 2 - maline čuvane u hladnjaku 2 dana	18,5 mg
Uzorak 3 - maline čuvane na tamnom i hladnom prostoru 2 dana	20,1 mg
Uzorak 4 - smrznute maline (2 mjeseca)	24,7 mg
Uzorak 5 - džem od malina	7,7 mg

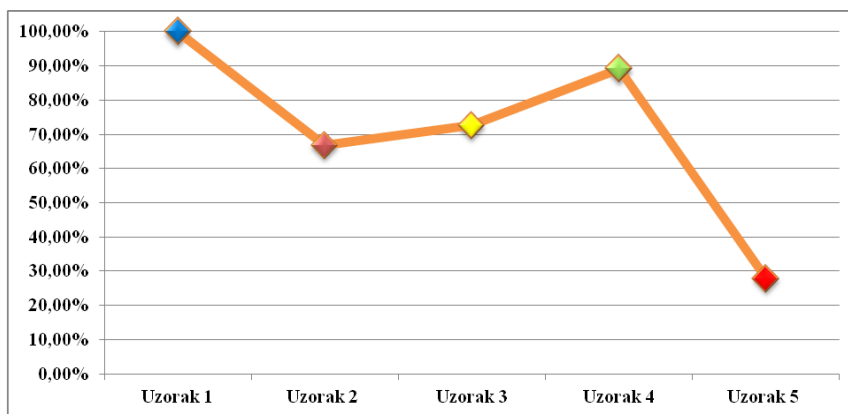

Graf 2. Prikaz smanjivanja sadržaja vitamina C tijekom skladištenja i konzerviranja malina
Chart 2. The reduction of vitamin C content during raspberries storage and preservation

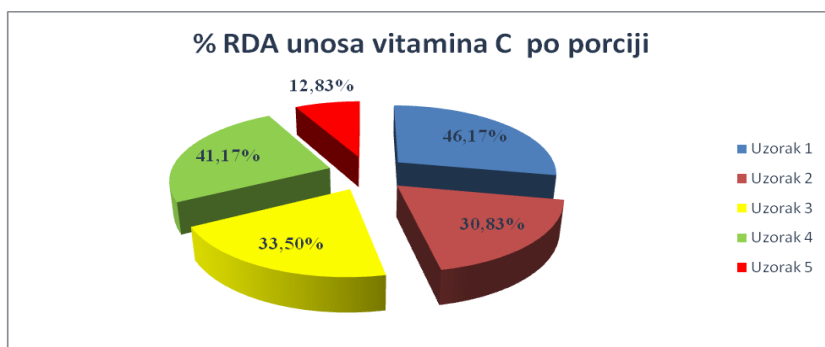

Graf 3. Prikaz zadovoljenja preporučene dnevnog unosa vitamina C konzumacijom 100 g ispitivanih uzoraka malina

Chart 3. The RDA adequacy review of vitamin C through the consumption of 100 g raspberry samples

Susret mladih kemičara / Meeting of Young Chemists

Manji gubitak količine vitamina C u uzorku čuvanom u tamnoj i hladnoj prostoriji u usporedbi s uzorkom čuvanim u hladnjaku može se objasniti osjetljivošću vitamina C na svjetlost. Međutim, iako uzorak 3. sadrži veću količinu vitamina C od uzorka 2., tijekom njegovog čuvanja došlo do je bržeg gubitka organoleptičkih svojstava i mikrobiološke ispravnosti, te on nije bio pogodan za konzumaciju. Uzorak 4. je predstavljao smrznute maline u periodu od 2 mjeseca u kojem je došlo do gubitka sadržaja vitamina C u iznosu od 10,8 %. Ovaj gubitak vitamina C predstavlja najmanje smanjenje sadržaja vitamina C u odnosu na ostale načine skladištenja i konzerviranja malina, što se može objasniti samom metodom smrzavanja koja je brza i najučinkovitija pri konzerviranju namirnica na dulji vremenski period. Metodom smrzavanja izdvaja se voda u obliku kristala, pri čemu se zaustavljaju svi kemijski, biokemijski i mikrobiološki procesi što čini namirnice pogodne za naknadnu konzumaciju.

Prema podacima u literaturi o kemijskom sastavu malina (Tablica 1), rezultati ovog rada pokazuju da svježije maline uzgojene na obiteljskom-poljoprivrednim gospodarstvima s područja općine Žepče sadrže veći udio vitamina C u usporedbi s prosjekom. Također konzumacijom 100 g svježih malina doseže se oko 50% preporučenog dnevnog unosa vitamina C za odrasle osobe. Brojna studijska istraživanja povezuju antioksidacijski kapacitet malina sa sadržajem vitamina C. Interakcijom flavonoida s drugim fiziološkim antioksidantima kao što su vitamin C i E, nastaje sinergistički učinak antioksidativnog djelovanja. Flavonoidi regeneriraju askorbinsku kiselinu, koja onda regenerira vitamin E (Cossins i sur., 1998). Potrebno je provesti daljnja istraživanja o antioksidacijskom kapacitetu malina s područja općine Žepče.

Zaključci

Prema izmjerenim podacima o sadržaju vitamina C u uzrocima svježih i konzerviranih malina s područja općine Žepče može se zaključiti:

- Svježije maline s područja općine Žepče izrazito su bogate vitaminom C u odnosu na prosječne podatke iz literature.
- Konzumacijom 100g svježih malina doseže se oko 50% preporučenog dnevnog unosa vitamina C za odrasle osobe.
- Najmanji gubitak vitamina C je u uzorku smrznutih malina i iznosi 10,8% u periodu od dva mjeseca.
- Čuvanje malina u hladnjaku ili tamnom i mračnom prostoru ne utječe znatno na razlike u gubitku vitamina C u ovim uzorcima. Usporedbom ovih uzorka postoji znatan utjecaj na narušavanje organoleptičkih i mikrobioloških svojstva malina u uzroku čuvanom na hladnom i mračnom prostoru.
- Džem od malina je sadržavao najmanju količinu vitamina C u odnosu na ostale uzorke, što se može objasniti procesom proizvodnje džema koji zahtjeva nepovoljne uvjete za očuvanje termostabilnog vitamina C.

Literatura

- Bobinaite, R., Viskelis, P. Venskutonis, P. R. (2012): Variation of total phenolics, anthocyanins, ellagic acid and radical scavenging capacity in various raspberry (*Rubus* spp.) cultivars, *Food Chem.* 132, 1495-1501.
- Haffner, K., Rosenfeld, H. J., Skerde, G., Wang, L. (2002): Quality of red raspberry *Rubus idaeus* L. cultivars after storage in controlled and normal atmospheres. *Postharvest Biol. Technol.*, 24, 279-289.
- Jakobek L., Šeruga, M., Novak, I., Medvidović-Kosanović, M., Lukačević, I. (2008): Antioksidacijska aktivnost polifenola iz borovnice i jagode. *Pomologia Croatica*, 14, 13-26.
- Kordić, M. Utjecaj načina hlađenja te sastava atmosfere na antioksidacijski kapacitet zapakiranih plodova malina tijekom skladištenja < <https://repositorij.pbf.unizg.hr>> Pristupljeno 12.7.2016.
- Manganaris, G. A., Goulas, V., Vicnete, A. R. and Terry, L. A. (2014): Berry antioxidants: small fruits providing large benefits. *J. Agric. Food Chem.* 94, 825-833.
- Pantelidis, G. E., Vasilakakis, M., Manganaris, G. A and Diamantidis, Gr. (2007): Antioxidant capacity, phenol, anthocyanin and ascorbic acid contents in raspberries, blackberries, red currants, goosberries and Cornelian cherries. *Food Chem.* 102, 777-783.
- Razvojna agencija Žepče (2016): Informacija o trenutnom stanju u sektoru jagodičastog voća u općini Žepče
- USDA (2015): United States Department of Agriculture – Natural Resources Conservation Service, < <https://fnic.nal.usda.gov/>> Pristupljeno 10.7.2016.

The vitamin C content in raspberries from the municipality of Žepče

Tomislav Jozinović, Maja Stojanović*

*Catholic school center "Don Bosco" Žepče, General gymnasium, Stjepana Radića bb,
72230 Žepče, Bosnia and Herzegovina*

**Corresponding author: majastojanovic1807@gmail.com*

Summary

Municipality of Zepce is one of the strongest areas in Bosnia and Herzegovina when it comes to the total amount of produced and repurchased raspberries. The biological value of foods is often determined by the vitamin content. Vitamins are essential micronutrients in human diet and lack of vitamins leads to development of various diseases in humans. Vitamin C has important functions in human body. The most important are metabolic activity stimulation, maintenance of healthy blood vessels and stimulation of the immune system. Apart from vitamins, raspberries also contain biologically active components (phytochemicals) that show a positive effect on human health. Scientists suggest that the interaction of phytochemicals with other physiological antioxidants as vitamins C and E produces a synergistic effect of antioxidant activity. Raspberries are extensively used in human diet because they have low energy value, great biological importance, pleasant aroma and taste, and various health benefits.

The aim of this study is to determine the quantity of the vitamin C content in various samples prepared from fresh and preserved raspberries, which are produced on family farms in the municipality of Zepce, by using volumetric method – iodine titration.

In this study the vitamin C content is determined by using the volumetric method – iodine titration. The results of this study show significant differences of the vitamin C content in various samples of raspberries.

Keywords: raspberry, vitamin C, municipality of Zepce, iodine titration

Tvrdoća vode u općini Žepče

Kristina Šimić, Slavica Jukić*

*Katolički školski centar "Don Bosco" Žepče Opća gimnazija, Stjepana Radića bb,
72230 Žepče, Bosna i Hercegovina*

**Dopisni autor: slavica.perkovic71@gmail.com*

Sažetak

Bitna značajka kvalitete vode je njena tvrdoća. Tvrdoća vode potječe od otopljenih soli kalcija i magnezija. Kalcij i magnezij nalaze se u prirodnim vodama u obliku hidrogenkarbonata, sulfata, klorida ili nitrata. Tvrdoća vode najčešće se izražava u mg/L kalcijevog karbonata (CaCO_3), ali i preko njemačkih, francuskih i engleskih stupnjeva tvrdoće. Ove soli su štetne u vodama jer reagiraju sa sapunima, stvarajući netopive spojeve, a uz to se i talože na ogrjevnim površinama kotlova i cijevi. Višestruke su štetne posljedice stvaranja vodenog kamenca, počevši od malih kućanstava pa do velikih industrijskih postrojenja. Zbog toga se tvrdoći vode i borbi protiv kamenca pridaje sve veća pozornost. Poznato je da su kalcij i magnezij esencijalni elementi, neophodni za normalno funkcioniranje ljudskog organizma, a unosimo ih putem hrane i pića. Od ukupno potrebne količine ovih metala, između 5 – 20 % dobiva se putem vode za piće. Unatoč svemu navedenom, u općini Žepče ne postoje službeni podaci o tvrdoći žepačkih voda, jer Pravilnik o zdravstvenoj ispravnosti vode za piće više ne propisuje određivanje ovih karakteristika. Stoga je u ovom istraživanju provedena analiza žepačkih voda u suradnji s Institutom za zdravlje i sigurnost hrane Zenica. Kompleksometrijskom metodom za pet uzoraka uzetih na različitim mjestima na području općine Žepče određeni su: alkalitet, sadržaj iona kalcija i magnezija, te ukupnu tvrdoću vode. Dobiveni podatci su ukazali na značajne razlike ovih parametara na ispitivanim uzorcima.

Ključne riječi: tvrdoća vode, vodeni kamenac, kalcij, magnezij, općina Žepče, kompleksometrijska metoda

Uvod

Voda je najvažniji čimbenik u nastajanju života. Čak je 80% zemljine površine prekriveno vodom, a naše tijelo je sadrži još više. Dakle, sav je život nastao i održava se u vodi. Čovjek bez vode može živjeti svega 72 sata, ali, nažalost, posljednji podaci pokazuju da je svega 1% pitke vode na Zemlji ispravno i potpuno neškodljivo za čovjeka. Posljednjih se godina obnovilo vjerovanje da voda posjeduje moći koje nadilaze ono što možemo zaključiti iz njene kemijske strukture. Ona, kako vjeruju mnogi istraživači, ima stanovitu moć memorije. Disciplina koje se bavi dokazivanjem ove tvrdnje zove se *digitalna biologija*, a njen je tvorac dr. Jacques Benveniste. Ako se ova teza pokaže točnom, mnoge važeće znanstvene teorije bi mogle doživjeti znatne revizije. Pod utjecajem Sunčeva zračenja površinska voda neprekidno se isparava u atmosferu, gdje se kondenzira i u obliku oborina vraća na Zemlju, prenoseći tako velike mase vode na kontinente, i to zovemo globalni hidrološki ciklus, pa u mnogome utječe na klimu. U troposferi voda čini 80% stakleničkih plinova i uzrokuje zadržavanje topline, te porast globalne temperature.

Susret mladih kemičara / Meeting of Young Chemists

Rasprostranjenost vode na Zemlji (volumni udjel)

morska voda	96,652 %
polarni led i ledenjaci	1,702 %
podzemna voda	1,631 %
površinska voda (jezera i rijeke)	0,013 %
voda u tlu	0,001 %
voda u atmosferi	0,001 %

Kemijski čista voda u prirodi ne postoji:

Najčišća kišnica sadrži u sebi otopljenje plinove i nečistoće iz atmosfere,
npr. CO₂, O₂, N₂, NH₃.

Iz atmosfere nad industrijskim mjestima i velikim gradovima kišnica apsorbira SO₂,
H₂S, H₂SO₄, čađu i prašinu.

U primorskim krajevima sadrži morsku sol i to do 15mg/l.

Za vrijeme nevremena i oluja može doći do stvaranja ozona i dušične kiseline,
koji se također otapaju u vodi.

Važnost vode u ljudskom organizmu

Za sve što tijelo čini, potrebna mu je voda. Voda izgrađuje, regulira, prenosi, čisti i pomaže hraniti svaki pojedini dio tijela. Kvaliteta vode koju pijete može radikalno utjecati na vaše zdravlje. Voda je osnovni sastojak svih tjelesnih tekućina, uključujući krv, limfu, slinu, izlučevine iz žlijezda i tekućinu leđne moždine. Voda čini 92% krvi i cerebrospinalne tekućine, 98% crijevnih i želučanih sokova, sokova žlijezde gušterače te sline.

Voda igra važnu ulogu u svim procesima našeg organizma:

- podmazuje organe i tkiva
- regulira temperaturu
- ispire otpadne tvari i toksine
- vlaži kožu
- hrani zglobove, kosti i mišiće
- prenosi nutrijente do vitalnih organa

Dovoljna količina vode u organizmu smanjuje zadržavanje otpadnih tvari i toksina u tijelu, poboljšava funkcije žlijezda i hormona, oslobađa jetru od viška masnoća i smanjuje glad. Čovjek može bez hrane živjeti mjesec dana, ali bez vode samo otprilike 72 h.

Anomalija vode

Većini se tvari sniženjem temperature volumen smanjuje. Međutim, snizujemo li temperaturu vode počevši od sobne temperature, volumen će joj se (kao i većini drugih tvari) smanjivati, ali samo do 4 °C, a zatim će joj se daljnjim snižavanjem temperature volumen povećavati. Budući da je takvo ponašanje vode neuobičajeno i neočekivano, tu pojavu zovemo *anomalija vode*. Anomalija vode je uzrok pojavi da led pliva na vodi, a isto tako i pojavi da staklena boca napunjena vodom u slučaju pothlađivanja ispod 0 °C pukne.

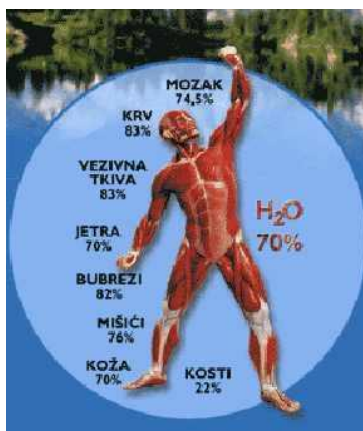

Slika 1. Udio vode u ljudskom organizmu
Fig. 1. Water content in the human body

Alkalitet vode

Alkalitet je mjera puferske sposobnosti vode, tj. sposobnosti vode da neutralizira dodanu kiselinu. Izražava se u ppm CaCO_3 . Kiseline dolaze u vodu kišnicom ili snijegom i rjeđe kroz tlo. Alkalitet nastaje kada voda otapa stijene koje sadrže kalcijev karbonat. Ukoliko jezero ili tekućica imaju nizak alkalitet (ispod 100 mg/l), veliki utok kiseline (npr. snažne i dugotrajne oborine) može privremeno potrošiti sav alkalitet te dovesti do pada pH vode. Nizak pH štetan je za većinu životinjskih organizama u vodi. Gorska jezera često imaju nizak alkalitet te su posebno osjetljiva u proljeće za vrijeme otapanja snijega, kada u vodu ulaze štetne tvari, a upravo je to vrijeme kad u vodi buja život. Alkalitet vode čine hidroksidi, karbonati i bikarbonati (hidrogen-karbonati) alkalnih i zemnoalkalnih metala, uglavnom natrija, kalcija i magnezija. Osnovne komponente koje doprinose alkalitetu vode su hidroksilni, karbonatni i bikarbonatni ioni:

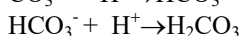
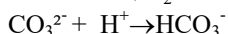
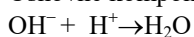

$$\text{ALKALITET} = [\text{OH}^-] + 2[\text{CO}_3^{2-}] + [\text{HCO}_3^-] - [\text{H}^+]$$

Površinske vode s visokom vrijednošću alkaliteta će neutralizirati kisele kiše i spriječiti promjene pH, koje bi mogle biti pogubne po vodene organizme. Alkalitet se izražava u jedinicama: mg CaCO_3 /L ili mg Ca/L ili $\mu\text{mol H}^+$ /L

Tvrdoća vode

Tvrdoća vode je mjerilo učinka vode za njeno reagiranje sa sapunom. Uzrokovana je prisutnošću topljivih soli kalcija i magnezija. Najveća je koncentracija kalcija, zbog prisutnosti u Zemljinoj kori kao ključnog počela u mineralima kalcitu, dolomitu... Kalcij i magnezij spadaju u esencijalne minerale i korisni su za ljudsko zdravlje. Tvrdoća vode ne utječe na zdravstvenu ispravnost vode. U svom prirodnom stanju u jezerima i podzemnim nalazištima, voda je u stanju ravnoteže. Međutim, tijekom prenošenja i korištenja dolazi do promjena u tlaku i/ili temperaturi koje uzrokuju prirodnu

Susret mladih kemičara / Meeting of Young Chemists

kemijsku reakciju: oslobađa se ugljikov dioksid i kako je kalcij u vodi povezan s ugljikovim dioksidom, kalcij se taloži u obliku kristala. Kemijskim metodama se određuje ukupna, prolazna, stalna, karbonatna tvrdoća, ali i kalcijeva i magnezijeva tvrdoća. Najčešće tražen podatak je za ukupnu tvrdoću koja se obično izražava u mg/L CaCO₃, ali i preko njemačkih, francuskih i engleskih stupnjeva tvrdoće. Kvaliteta vode prema ukupnoj tvrdoći:

< 4 °d	meka voda
4-8 °d	lagano tvrda voda
9-18 °d	umjereno tvrda voda
18-25 °d	tvrda voda
> 25 °d	vrlo tvrda voda

Prolazna (privremena) tvrdoća potječe od kalcija i hidrogenkarbonata i eliminira se kuhanjem:

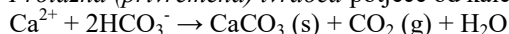

Stalna tvrdoća se odnosi na sulfate i kloride kalcija i magnezija.

Ukupna tvrdoća vode: stalna + privremena

Nastajanje vodenog kamenca

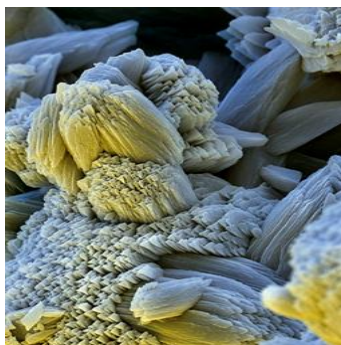

Slika 2. Kamenac snimljen elektronskim mikroskopom (vidno polje je 64x90 μm)

Fig. 2. Limescale recorded by an electronic microscope (field of view is 64x90 microns)

Nastanak vodenog kamenca na stjenkama vodovodnih sustava ovisi o mnogim procesima. Najbitnija su sljedeća tri: pH vrijednost vode, temperatura i tlak u vodi. Topljivost minerala-uzročnika kamenca upravo ovisi o tim parametrima. Topljivost kalcijevog karbonata se smanjuje s porastom pH vrijednosti i temperaturom vode, a raste sa smanjenjem tlaka u vodovodnom sustavu. Pri grijanju vode dolazi do poremećaja kemijske ravnoteže i izdvajanja taloga:

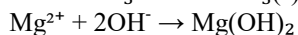
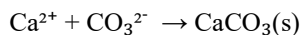

U sustavima grijanja, na mjestima snažne izmjene topline dolazi do jakog taloženja i stvaranja čvrstih naslaga na stjenkama kroz koje se izmjenjuje toplina (npr. cijevni električni grijači vode u strojevima za pranje rublja, cijevi parnih kotlova, bojleri). Taloženje kamenca nastaje složenim fizikalno-kemijskim procesom, kristalizacijom. Vodeni kamenac se uglavnom sastoji od kalcijevog i magnezijevog karbonata, ali taloženjem ti karbonati povlače za sobom i ostale soli, tako da se u sastavu kamenca mogu naći i natrijev klorid (NaCl), natrijev nitrat (NaNO₃), kalijev nitrat (KNO₃), kalijev sulfat (K₂SO₄). CaCO₃ ima tri različita polimorfna oblika i svaki pokazuje različita fizička, a donekle i kemijska svojstva: kalcit, aragonit i viterit. Kod vodenog kamenca se uglavnom pojavljuju kalcit i aragonit. Kalcit se stvara pri manjim temperaturama (ispod 30°C), lako se odstranjuje uz pomoć slabe kiseline. Aragonit se formira pri višim temperaturama (iznad 30 °C), teže ga je odstraniti jer ima rombsku kristalnu rešetku. Aragonit je posebno opasniji od kalcita jer formira tvrđe i gušće naslage od kalcita.

Posljedice nakupina vodenog kamenca

Posljedice uzrokovane nakupinama vodenog kamenca mogu biti višestruke, neke od njih su :

1. Povećana potrošnja energije, jer svega 3 mm kamenca na grijačima uzrokuje oko 25 % veći trošak energije.
2. Ometanje pravilnog toka vode uslijed smanjenja poprečnog presjeka
3. Veći troškovi održavanja vodovodnih instalacija i uređaja
4. Smanjena sigurnost pogona i smanjen vijek trajanja uređaja
5. Povećana upotreba sredstva za pranje i čišćenje
6. Potrebno je više vremena za čišćenje slavina, sudopera, umivaonika, kada, keramičkih pločica...
7. Smanjena kvaliteta vode
8. Stvaranje korozije
9. Štetnost za prirodu (npr. zbog veće potrošnje energije i povećanog korištenja sredstva za pranje)

Uklanjanje kamenca

Metode uklanjanja dijele se na kemijske i fizikalne metode.

Kemijske metode rade na principu "omekšavanja" vode. Omekšana voda se koristi u različitim proizvodnim procesima (npr. kod bojanja), ali nije pogodna za konzumiranje.

Ionska izmjena je postupak koji uključuje upotrebu ionskih izmjenjivača koji mogu vezati ione iz otopine, a otpuštati jednaku (ekvivalentnu) količinu vlastitih iona. Ionski izmjenjivači su uglavnom visokopolimerni spojevi (postoje i mineralni) koji imaju svojstvo da vežu ione iz otopine, a pri tome oslobađaju jednaku količinu istoimeno nabijenih iona. Ion ionske smole sadrži različite kopolimere čvrsto vezane u trodimenzionalanu strukturu na koju su pričvršćene ionske skupine. Ovisno o strukturi imamo kationske i anionske izmjenjivače. Upotrebljavaju se za prečišćavanje različitih otopina, lijekova, omekšavanje ili demineraliziranje vode i drugo. Fizikalne metode zasnivaju se na prirodnom fenomenu djelovanja magnetnog polja na taloženje kamenca. Magnetno polje može se inducirati strujom ili se dobiva iz "prirodnih" magneta. Ova je metoda sve prihvaćenija u svijetu budući da ne mijenja kemijski sastav vode. Radi na principu prirodnog permanentnog (stalnog) magneta. Snaga magneta gubi samo 0.1% svoje snage u 30 godina.

Susret mladih kemičara / Meeting of Young Chemists

Prolaskom vode kroz uređaj, mijenja se naboj čestica. Čestice tako promijenjenog naboja, počinju privlačiti kristale kalcija. Kristali kalcija vežu se s česticama i prolaze kroz instalaciju umjesto da se talože na stijenkama instalacija. Tretiranje tekuće vode obavlja se bez uporabe bilo kakvih kemijskih dodataka ili rezanja vodovodnih cijevi. Uporabom ovakvih uređaja produžuje se radni vijek kućanskih aparata, smanjuju se troškovi održavanja grijača u sustavu grijanja sanitarne vode, troši se značajno manje energije za iste toplinske učinke, održavanje čistoće sanitarija mnogo je lakše i brže uz manju potrošnju raznih čistila i deterdženata. Za uklanjanje kamenca u domaćinstvu koriste se: limunska kiselina, soda bikarbona, ocat, solna kiselina.

Materijali i metode

Metoda 1:

Određivanje alkaliteta vode, Ca^{2+} i Mg^{2+}

Pribor i posuđe: porculanske zdjelice, kapaljke, stakleni štapići, pipete, propipete, menzure

Kemikalije: metil oranž, HCl, 30% NaOH, indikator mureksid, komplekson III, pufer (NH_3-NH_4Cl), indikator erikrom-crno T

Uzorci vode

Svih pet uzoraka vode smo uzeli s područja općine Žepče. Jedan uzorak jest gradska voda dok smo preostala četiri uzeli iz okolnih sela i naselja.

Uzorak 1: Žepče (gradski vodovodni sustav)

Uzorak 2: Globarica (seoski izvor)

Uzorak 3: bunarska voda (Selište)

Uzorak 4: Vitlaci (seoski izvor)

Uzorak 5: D. Lug- Branković (seoski izvor)

Postupak

Odmjeri se 50 ml uzorka vode za analizu u porculansku zdjelicu i doda 2 kapi metil oranža. Titrira se 0,1 M HCl do promjene boje u oranž nijansu. Na osnovu utroška 0,1 M HCl računa se alkalitet, odnosno karbonatna tvrdoća na sljedeći način:

$Alkalitet = V(HCl) \times 2 \times 2,8 = \text{karbonatna tvrdoća } (^{\circ}dH)$

Ispitivanom uzorku dodamo u suvišku 1 ml 0,1 M HCl i zagrijavamo kako bi kuhanjem istjerali prisutni CO_2 . Uzorak vode za analizu ohladimo a zatim vršimo određivanje kalcija i magnezija u vodi na sljedeći način:

Određivanje Ca^{2+}

U ohlađenu zdjelicu s uzorkom vode dodamo 4 kapi 30% NaOH do pH 12. Zatim dodamo 0,2 – 0,4 g indikatora mureksida. Kad je prisutan Ca otopina će se obojiti u crveno. Titriramo sa kompleksonom III do promjene boje u ljubičastu.

Izračunavanje sadržaja Ca u ispitivanom uzorku vode na osnovu utrošenih kompleksona III

$Ca^{2+} = \text{utrošeni ml kompleksona III} \times 2 \times 8,016$

$CaO = \text{mg } Ca^{2+} \times 1,4$

Određivanje Mg²⁺

Ispitivanom uzorku vode dodajemo 10% HCl do kisele reakcije i prokuhamo kako bi time uništili boju koja potječe od mureksida. Zatim dodamo 2 ml pufera (NH₃-NH₄Cl) do pH=9 a nakon toga indikator eriochrom-crno T i titriramo s kompleksom III do promjene boje u plavu.

Izračunavanje sadržaja Mg u ispitivanom uzorku na osnovu utrošenih mL kompleksona III

$$m(\text{Mg}^{2+}) = \text{utrošeni ml kompleksona III} \times 2 \times 4,84$$

$$m(\text{MgO}) = \text{mg Mg}^{2+} \times 1,6$$

Na osnovu dobivenih rezultata vršimo proračun za ukupnu tvrdoću, stalnu tvrdoću i isparni ostatak na sljedeći način:

$$\text{UKUPNA TVRDOĆA} = (m(\text{MgO})/10 \times 1,4) + (m(\text{CaO})/10)$$

$$\text{STALNA TVRDOĆA} = \text{ukupna tvrdoća} - \text{karbonatna tvrdoća}$$

$$\text{ISPARNI OSTATAK} = [(m(\text{MgO})/10 \times 1,4) + m(\text{CaO})/10] \times 20$$

Metoda 2:

Određivanje zbroja iona Ca²⁺ i Mg²⁺

Reagensi:

1. 0,025 M EDTA
2. Amonijačni pufer (pH 10)
3. Eriokromcrno T: (suho razrjeđenje s NaCl 1:100 u tarioniku s tučkom)

Postupak

50,0 ml vode za analizu se odmjeri u erlenmayerovoj tikvici od 250 ml i doda se 5,0 ml amonijačnog pufera i 0,1 g eriochromcrnog T. Titrira se sa EDTA do promjene boje iz crvene u plavu.

$$\text{Ca}^{2+} + \text{Mg}^{2+} \text{ mmol/dm}^3 = (V \times M / 50) \times 1000 = V/2$$

Određivanje iona Ca²⁺

Reagensi:

1. mureksid
2. 2M NaOH
3. 0,025 M EDTA

Postupak

Odmjeri se 50,0ml od uzorka vode za analizu, doda se 3 ml 2M NaOH (pH=12) i mureksid. Titrira se sa EDTA do promjene boje u ljubičastu.

$$\text{Ca}^{2+} \text{ mmol/dm}^3 = (V_1 \times M / 50) \times 1000 = V_1 / 2$$

$$\text{mg/dm}^3 = \text{mmol/dm}^3 \times 40,08$$

Izračunavanje sadržaja Mg²⁺

$$\text{Mg}^{2+} \text{ mmol/dm}^3 = \text{mmol}(\text{Ca}^{2+} + \text{Mg}^{2+})/\text{dm}^3 - \text{mmol Ca}^{2+}/\text{dm}^3$$

Susret mladih kemičara / Meeting of Young Chemists

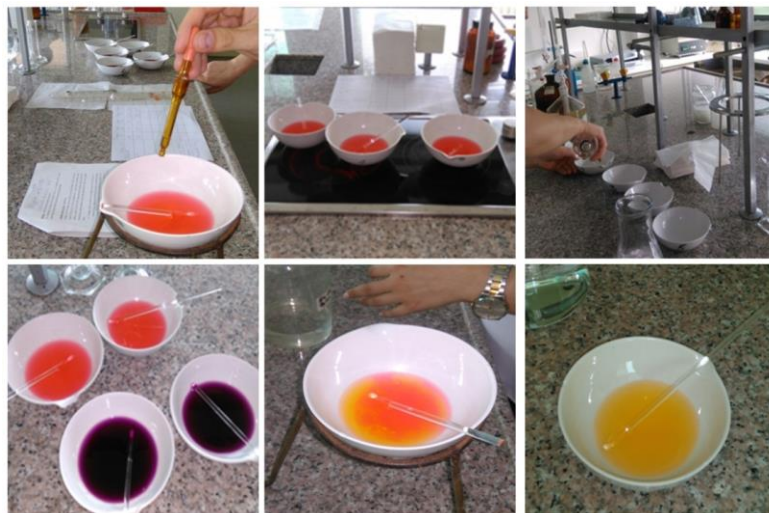

Slika 3. Analiza uzoraka
 Fig 3. Analysis of samples

Tablica 1. Rezultati istraživanja
 Table 1. Research results

REZULTATI	UZORAK 1	UZORAK 2	UZORAK 3	UZORAK 4	UZORAK 5
Karbonatna tvrdoća (°dH)	6,16	21,28	6,16	16,24	16,24
Ca ²⁺ (mg/dm ³)	25,65	107,41	24,05	9,619	37,52
CaO (mg/dm ³)	35,91	150,37	33,66	22,44	150,38
Mg ²⁺ (mg/dm ³)	13,55	30,98	12,58	65,82	7,74
MgO(mg/dm ³)	21,68	49,56	20,13	105,31	12,39
Ukupna tvrdoća (°dH)	6,62	22,41	6,18	16,98	16,77

(Istraživanje je izvršeno na Institutu za zdravlje i sigurnost hrane u Zenici.)

Rasprava i zaključci

Kvaliteta vode prema ukupnoj tvrdoći:

Uzorak 1 – lagano tvrda voda

Uzorak 2 – tvrda voda

Uzorak 3 – lagano tvrda voda

Uzorak 4 – umjereno tvrda voda

Uzorak 5 – umjereno tvrda voda

Uzorak 1 (gradska voda) je s otvorenog izvora u čijem sastavu ima i kišnice. Zbog toga je takva voda lagano tvrda voda (6,62 °d), s niskom karbonatnom tvrdoćom 6,16°d, te relativno malo iona kalcija i iona magnezija.

Uzorak 2 (Globarica) ima najveću ukupnu tvrdoću (22,41°d), visoku karbonatnu tvrdoću (21,28°d) te znatno veći sadržaj iona kalcija (107,41 mg/L) u odnosu na ione magnezija (30,98 mg/L), što upućuje na zaključak da je ova voda kalcijско-hidrogenkarbonatnog tipa.

Uzorak 3 (Selište) ima najmanju tvrdoću (6,18°d) i ova voda se ubraja u lagano tvrde vode. Ovaj uzorak dolazi iz izvora koji je bušotina na 100m u ravničarskim predjelima Žepča. Ima najniže vrijednosti iona kalcija (24,05 mg/L) i magnezija (12,58 mg/L).

Uzorak 4 (Vitlaci) je umjereno tvrda voda (16,98 °d), a znatno veći sadržaj iona magnezija (65,82 mg/L) u odnosu na ione kalcija (9,619 mg/L) upućuje kako voda prolazi kroz magnezitne stijene.

Uzorak 5 (Lug-Brankovići) je također, umjereno tvrda voda (16,77°d), ali za razliku od uzorka 4 ima znatno veći sadržaj iona kalcija (37,52 mg/L) u odnosu na ione magnezija (7,74 mg/L).

Analizom samo pet uzoraka uzetih na različitim lokacijama u općini Žepče utvrdili smo kako se parametri poput karbonatne tvrdoće, sadržaja iona kalcija i iona magnezija te ukupne tvrdoće vode znatno razlikuju. Zbog toga, iako to nije Pravilnikom o zdravstvenoj ispravnosti vode za piće propisano, potrošačima savjetujemo da ispitaju i ove parametre te tako budu detaljnije upoznati s kvalitetom vode koju troše.

Literatura

<http://cudaprirode.com/portal/csvijeta/5783-10-zanimljivih-injenica-o-vodi> (12.9.2016.)

<http://www.aqua.hr/a/tvrdoca-vode> (12.9.2016.)

<http://www.zivotinje.rs/enciklopedijaStrana.php?id=2680&alias=tvrdoca> (10.9.2016.)

<http://www.hydrolux.info/english/06%20problemi/tvrdavoda.html> (10.9.2016.)

http://repozitorij.fsb.hr/2397/1/11_09_2013_ZAVRSNI_Mihalinec.pdf (10.9.2016.)

<http://www.agromarketing.hr/PO-OTvrdojVodi.html> (1.9.2016.)

<http://promogradnja.hr/uklanjanje-tvrdoce-iz-vode-omeksavanje-vode/> (20.8.2016.)

<http://fish.mongabay.com/croatian/fish13.html> (20.8.2016.)

<http://www.akvarij.net/index.php/kemija-menuosnoveisavjeti-89/96-osnove-o-kemijskim-vrijednostima-vode> (15.8.2016)

Hardness of water in the municipality of Žepče

Kristina Šimić, Slavica Jukić*

*Catholic school center "Don Bosco" Žepče, General gymnasium, Stjepana Radića bb,
72230 Žepče, Bosnia and Herzegovina*

**Corresponding author: slavica.perkovic71@gmail.com*

Summary

Hardness is an important feature of water quality. Water hardness originates from dissolved salts of calcium and magnesium. Calcium and magnesium are found in natural waters in the form of bicarbonates, sulphates, chlorides or nitrates. Water hardness is measured in mg/L of calcium carbonate (CaCO_3), but also in German, French or English degrees of hardness. These salts are detrimental in waters because they react with soaps, creating insoluble compounds, and are also deposited on heated areas of boilers and pipes. There are multiple consequences of creating limescale, starting from small houses to big industrial plants. That is why more attention is increasingly given to the issue of water hardness and the fight against limescale. It is known that calcium and magnesium are essential elements, necessary for normal functioning of the human body, and we take them in by means of food and drink. From the total recommended intake of these metals, 5-20 % is obtained by drinking water. Despite all of the above, in the municipality of Žepče there are no official data on water hardness of waters in Žepče, because the Statute of Health Safety of Drinking Water does not prescribe the assessment of these characteristics any more. Therefore the analysis presented in this research was conducted with the help of the Health and Food Safety Institute of Zenica. Using the complexometric method on five water samples taken on various places in the area of Žepče municipality the following criteria were determined: alkalinity, ion content of calcium and magnesium, and total water hardness. The obtained results revealed significant fluctuations of these parameters in the analyzed samples.

Keywords: water hardness, limescale, calcium, magnesium, municipality of Žepče, complexometric method

Kazalo autora
Author Index

A

Alivojvodić, Sara, 335

B

Babić, Kristina, 98, 120
Bakula, Ivan, 335
Balta, Vedran, 225
Belščak-Cvitanović, Ana, 155, 170, 189, 198, 250
Benković, Maja, 155, 189, 198
Briški, Felicita, 262
Brkić, Danijel, 209
Brozinčević, Andrijana, 277
Bukvić, Valerija, 25
Bušić, Arijana, 170, 250

C

Cvetković, Želimira, 209

Č

Čoklica, Sunčica, 25

Ć

Ćosić, Jasenka, 163
Ćosić, Marija, 51

D

Dobričević, Nadica, 182
Domanovac, Tomislav, 342
Dragović-Uzelac, Verica, 239
Dundović, Marija, 326
Duplančić, Marina, 98, 120
Durgo, Ksenija, 170

Dž

Džalto, Stjepan, 109

Đ

Đikić, Domagoj, 225, 239

F

Fabek, Sanja, 182
Fraguna, Fabio, 109
Franjić, Antonija, 182
Fras Zemljič, Lidija, 311, 353
Fumić, Monika, 239

G

Gajdoš Kljusurić, Jasenka, 155, 189
Galić, Ante, 182
Glasovac, Zoran, 109
Gomzi, Zoran, 98
Gotovac, Branka, 74
Grgas, Dijana, 277

H

Halamić, Josip, 209
Hubalek, Ivan, 1

J

Jakelić, Marija, 155, 189
Jakobek, Lidija, 146
Jozinović, Tomislav, 360
Jukić, Ante, 1, 109
Jukić, Slavica, 377
Jurina, Tamara, 155, 189, 198
Jurinjak Tušek, Ana, 155, 189, 198

K

Kaćunić, Antonija, 51, 74
Kantoci, Darko, 25
Keppler, Julia, 250
Kezerle, Antonija, 295
Klenkar, Jelena, 36

Kazalo autora / Author Index

Komes, Draženka, 170, 198, 250
Krivak, Petra, 146
Krivičić, Denija, 262
Kučić, Dajana, 262
Kuzmanić, Nenad, 51

L

Landeka Dragičević, Tibela, 277
Landeka Jurčević, Irena, 225, 239
Leskovac, Mirela, 133
Levanić, Davor, 209
Lisičar, Marina, 170

M

Marček, Tihana, 335
Medvidović Kosanović, Martina, 19, 146
Meštrović, Ernest, 317
Mihaljević-Herman, Vesna, 163
Mihelič, Rok, 353
Milosavljević, Nikola, 120
Mitar, Anamarija, 62
Mrčela, Ante, 289
Mužina, Katarina, 133

N

Nuić, Ivona, 302

P

Palfi, Marina, 163
Paradžik, Ivona, 225
Paveli, Tanja, 25
Pavičić, Mirjana, 295
Pavlović, Hrvoje, 295
Pecikozić, Đurđevka, 326
Pedisić, Sandra, 239
Peršić, Ana, 120
Pišonić, Marina, 19
Pitinac, Nada, 326
Plietić, Stjepan, 182

Popijač, Vesna, 25, 163
Prlić Kardum, Jasna, 62
Prodan, Morena, 277
Puhač Bogadi, Nina, 163

R

Radojčić Redovniković, Ivana, 62
Ranilović, Jasmina, 25
Rogošić, Marko, 86
Rušić, Davor, 74

S

Sabljić, Lea, 225
Sander, Aleksandra, 62, 86
Simonić, Marjana, 311, 353
Steffen-Heins, Anja, 250
Stojanović, Maja, 360

Š

Šabarić, Jasenka, 209
Šabić, Monika, 317
Šauperl, Olivera, 353
Šic Žlabur, Jana, 182
Šimić, Kristina, 377
Širac, Tea, 277
Šorša, Ajka, 209
Španić, Valentina, 335
Šter, Anamarija, 19, 146

T

Theismann, Eva Maria, 250
Tomas, Srećko, 1
Tomašić, Vesna, 98, 120
Trgo, Marina, 302

U

Ugrina, Marin, 302
Uršulin-Trstenjak, Natalija, 209

V

Valinger, Davor, 155, 189, 198

Velić, Natalija, 295

Veljačić, Anamarija, 289

Veljačić, Luči, 289

Viljevac Vuletić, Marija, 335

Voća, Sandra, 182

Vojvodić, Aleksandra, 170, 250

Vujnović, Mirna, 133

Vukić, Petra, 317

Vukojević Medvidović, Nediljka, 302

Vuković Domanovac, Marija, 317, 342

Z

Zagajski Kučan, Kristina, 86

Zelić, Bruno, 326

Zorić, Zoran, 239

Sponzori, donatori i izlagači
Sponsors, donors and exhibitors

Sponzori, donatori i izlagači / Sponsors, donors and exhibitors

Zlatni sponzori / *Gold sponsors*



Srebrni sponzor / *Silver sponsor*



Sponzori i donatori / *Sponsors*



Izlagači / Exhibitors



Sponzori, donatori i izlagači / Sponsors, donors and exhibitors

ZLATNI SPONZOR / GOLDEN SPONSOR



* dokazano najbolja

Vaša vjernost je naša misija

Gradeći uspjeh na tradiciji, iskustvu i inovativnosti, pomičemo granice u naftnom i plinskom poslovanju te pružamo najvišu kvalitetu proizvoda i usluga. Hrvatska proizvodnja, europska kvaliteta, stroga kontrola, potpuna odgovornost.



ZLATNI SPONZOR / GOLDEN SPONSOR

**VEĆ
GENERACIJAMA
ZNANJE VRAĆAMO
ZAJEDNICI.**



TEVA

PLIVA

PLIVA, TO SU LJUDI POSVEĆENI ZDRAVLJU.

www.pliva.hr

Sponzori, donatori i izlagači / Sponsors, donors and exhibitors

SREBRNI SPONZOR / SILVER SPONSOR



IZLAGAČ / EXHIBITOR

The advertisement features various scientific instruments from KOBIS and Thermo Scientific. The KOBIS logo is on the left, and the Thermo Scientific logo is on the right. The central text provides contact information for KOBIS.

KOBIS

- Tekućinska kromatografija
- Plinska kromatografija
- Masena spektroskopija
- Elementarna analiza
- Molekulska spektroskopija
- Reologija
- Priprema uzorka
- pH/ISE metri, turbidimetri...

thermo scientific

- Ekstruderi
- Potrošni materijal
- Fotometrijski analizator
- Analiza izotopnog omjera
- Analiza površina
- Tehnička i edukacijska podrška stručnih i certificiranih inženjera

www.kobis.hr
Kontakt:
kobis@kobis.hr
01 6545 742

45 godina pouzdan partner u
obrazovanju, znanosti i struci

PTFOS

OBRAZOVANJE

PREDDIPLOMSKI SVEUČILIŠNI STUDIJ

Prehrambena tehnologija

DIPLOMSKI SVEUČILIŠNI STUDIJ

Prehrambeno inženjerstvo

Procesno inženjerstvo

Znanost o hrani i nutricionizam

POSLIJEDIPLOMSKI SVEUČILIŠNI STUDIJ

Prehrambeno inženjerstvo

POSLIJEDIPLOMSKI SPECIJALISTIČKI STUDIJ

Sigurnost i kvaliteta hrane

Tehnologije tradicionalnih mesnih proizvoda

Nutricionizam

CJELOŽIVOTNO OBRAZOVANJE

Program testiranja, treninga i edukacije za senzorsku analizu meda

Program edukacije proizvođača slavonske kobasice na OPG-ima

Program za stjecanje nedostajućih znanja, vještina i kompetencija

za upis na diplomске sveučilišne studije PTF Osijek

Program edukacije proizvođača sira na OPG-ima

Uspostava sustava sigurnosti hrane u ugostiteljskim objektima

i malim poduzećima

Edukacija proizvođača slavonskog kulena na OPG-ima

Industrijsko sušenje

Kvaliteta voća i povrća, skladištenje, priprema za prodaju i preradu

Senzorska analiza u prehrambenoj industriji

Zdravlje iz tanjura

Suvremeni tehnološki postupci proizvodnje voćnih destilata

LABORATRIJSKE ANALIZE
Analize sirovina, poluproizvoda i gotovih proizvoda prema važećim
pravinicima:
• analize: mlijeka, meda, mesa i mesnih preradevina, piva, vina, voća i
povrća, vode za piće, voćnih sokova, žitarica i proizvoda od žitarica,
krmiva, životinjskih analize
• mikrobiološke analize
• određivanje mikrokoksina
• analize otpadnih voda i dr.

Sveučilište Josipa Jurja Strossmayera
Prehrambena-tehnološki fakultet Osijek

ZNANSTVENI I STRUČNI RAD

Objedinjavanje i razvijanje znanstveno-istraživačkog i stručnog rada, suradnja s gospodarskim
okruženjem te gradskim, županijskim i državnim institucijama kroz:

- izradu analiza i ekspertiza
- izradu tehnološko-investicijskih projekata, programa i elaborata
- izrada stručnih prijedloga za rješavanje tehnoloških problema u postojećim tehnologijama
- konzalting
- razvoj novih proizvoda i procesa (tehnologija)
- optimiranje potrošnje energenata i drugih resursa
- kontrola namirnica i sirovina
- ispitivanje prehrane
- ostale poslove iz područja prehrambene, kemijske i bioprocne tehnologije.

www.ptfos.unios.hr

www.ptfos.unios.hr



IZDAVAČ | *Published by:*

Hrvatsko društvo kemijskih inženjera i tehnologa
Zagreb, 2017.