

Ružičkini dani : 13. međunarodni znanstveno-stručni skup Ružičkini dani "Danas znanost - sutra industrija" : zbornik radova

Ačkar, Đ.; Akrap, M.; Antonović, A.; Babić, J.; Bacci, E.; Barbir, D.; Bauman, I.; Beganović, J.; Benčina, L.; Benković, M.; ...

Edited book / Urednička knjiga

Publication status / Verzija rada: **Published version / Objavljena verzija rada (izdavačev PDF)**

Publication year / Godina izdavanja: **2011**

Permanent link / Trajna poveznica: <https://um.nsk.hr/um:nbn:hr:109:410518>

Rights / Prava: [Attribution-ShareAlike 4.0 International/Imenovanje-Dijeli pod istim uvjetima 4.0 međunarodna](#)

Download date / Datum preuzimanja: **2025-03-04**

REPOZITORIJ

PTFS

PREHRAMBENO-TEHNOLOŠKI FAKULTET OSIJEK

dabar
DIGITALNI AKADEMSKI ARHIVI I REPOZITORIJ

Repository / Repozitorij:

[Repository of the Faculty of Food Technology Osijek](#)



dabar
DIGITALNI AKADEMSKI ARHIVI I REPOZITORIJ



Croatian Society of Chemical Engineers
Faculty of Food Technology University of Josip Juraj Strossmayer in Osijek
European Federation of Food Science and Technology

International Scientific and Professional Conference

13th Ružička Days

"TODAY SCIENCE - TOMORROW INDUSTRY"



16th and 17th September 2010
Vukovar, Croatia

PROCEEDINGS



Hrvatsko društvo kemijskih inženjera i tehnologa
Prehrambeno-tehnološki fakultet Sveučilišta Josipa Jurja Strossmayera u Osijeku
European Federation of Food Science and Technology

Međunarodni znanstveno-stručni skup

XIII. Ružičkini dani

“DANAS ZNANOST – SUTRA INDUSTRIJA”

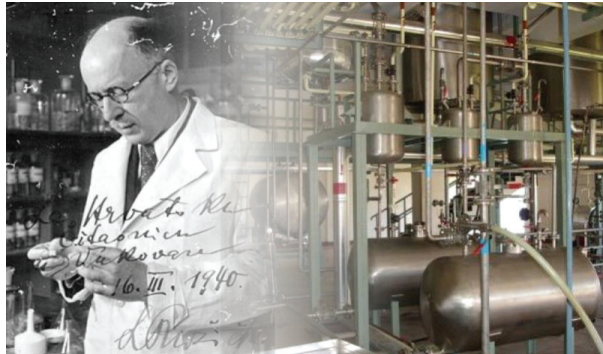

16. i 17. rujna 2010.
Vukovar, Hrvatska

ZBORNİK RADOVA

Osijek, 2011.

ZBORNİK RADOVA XIII. Ružičkini dani
DANAS ZNANOST - SUTRA INDUSTRIJA
PROCEEDINGS *13th Ružička days*
TODAY SCIENCE – TOMORROW INDUSTRY

Izdavači Prehrambeno-tehnološki fakultet Osijek
Hrvatsko društvo kemijskih inženjera i tehnologa (HDKI)
Published by *Faculty of Food Technology Osijek*
Croatian Society of Chemical Engineers

Glavni urednik Drago Šubarić
Chief Editor

Izvršna urednica Mirela Planinić
Executive Editor

Tehnička urednica Ivana Pavleković
Technical Editor

Tisak i uvez Grafika d.o.o.
Printed by

Naklada 200
Number of Copies

Osijek, 2011.

ISBN (PTF): 978-953-7005-26-9
ISBN (HDKI): 978-953-6894-43-7

CIP zapis dostupan u računalnom katalogu
Gradske i sveučilišne knjižnice Osijek pod brojem 130201016
*A CIP catalogue record for this publication is available from the
City and University Library Osijek under 130201016*

Scientific and Organizing Committee Drago Šubarić (chairman),
Srećko Tomas (vice-chairman),
Ante Jukić (vice-chairman),
Jurislav Babić, Mate Bilić, Ljubica Glavaš-Obrovac,
Vlado Guberac, Ivan Hubalek, Damir Ježek, Filip
Kljajić, Damir Magdić, Milena Mandić, Ivanka Miličić,
Ana Mrgan, Mira Nikolić, Ivana Pavleković, Mirela
Planinić, Milan Sak-Bosnar, Aleksandra Stjepanović,
Darko Vrbešić

Honorary Committee Ivan Butula, Petar Čobanković, Mirko Čavara, Radovan
Fuchs, Božo Galić, Marin Hraste, Zvonimir Janović,
Vlado Jerbić, Dragan Kovačević, Gordana Kralik,
Božidar Pankretić, Vlasta Piližota, Antun Pintarić, Đuro
Popijač, Jelenka Prelić, Mladen Proštenik, Željko Sabo,
Nenad Trinajstić

Under the Auspice of: Croatian Academy of Sciences and Arts
Department of Mathematical, Physical and Chemical
Sciences

Supported by: Ministry of Science, Education and Sports of the
Republic of Croatia

Ministry of Agriculture, Fisheries and Rural
Development of the Republic of Croatia

Ministry of Economy, Labour and Entrepreneurship of
the Republic of Croatia

Ministry of Regional Development, Forestry and Water
Management of the Republic of Croatia

Committee of the Economy of the Croatian Parliament

Croatian Academy of Engineering

University of Josip Juraj Strossmayer in Osijek

Vukovar-Srijem County

City of Vukovar

Plenarna predavanja
Plenary lectures

<i>J. Hribar, T. Požrl, R. Vidrih</i> Emerging technologies and their perspectives in food industry.....	1
<i>V. Piližota</i> Towards sustainable food production	15
<i>D. Kovačević</i> Komercijalizacija znanstvenih istraživanja u funkciji gospodarske konkurentnosti Hrvatske Commercialization of scientific research in the function of Croatia's competitiveness ..	26
<i>D. Ježek, S. Karlović, M. Brnčić, T. Bosiljkov, B. Tripalo</i> Obrada prehrambenih namirnica visokim tlakovima Food processing with high pressure.....	48
<i>A. Stjepanovic, H. Marit Østlie, S. Borghild Skeie</i> Novel food pathogen testing technologies: molecular biology methods.....	55
<i>G. Karminski-Zamola</i> Heterociklički kondenzirani kinoloni i kinolini kao potencijalni antitumorski agensi Heterocyclic condensed quinolones and quinolines as potential antitumor agents.....	69
Kemijska analiza i sinteza Chemical analysis and synthesis	
<i>V. Sokol, R. Tomaš, K. Šarić</i> Termodinamička svojstva RbBr i CsBr u smjesi 2-butanol (5 mas.%) + voda Thermodynamic properties of RbBr and CsBr in 2-butanol (5 mass.%) + water mixture	84
<i>R. Tomaš, V. Sokol, P. Bošković</i> Termodinamička svojstva CdCl ₂ u smjesi <i>tert.</i> butanol (5 mas. %) + voda Thermodynamic properties of CdCl ₂ in <i>tert.</i> butanol (5 mass. %) + water mixture.....	95
<i>M. Zekić, A. Radonić, I. Blažević, J. Mastelić, S. Bilić</i> Glucosinolate hydrolysis products from brassicaceae plants	107
Kemijsko i biokemijsko inženjerstvo Chemical and biochemical engineering	
<i>M. Akrap, D. Bralić, N. Kuzmanić</i> Kontinuirano mjerenje koncentracije dinatrijevog tetraborat dekahidrata tijekom procesa šaržne kristalizacije hlađenjem In-line bulk concentration measurement in batch cooling crystallization of borax decahydrate	115

<i>E. Bacci, D. Rušić, S. Svilović, R. Žanetić</i> Matematičko modeliranje kinetike heterogenih reakcijskih sustava <i>Modeliranje kinetike reakcijskih sustava koji imaju konverzijsku funkciju s infleksijom</i> Mathematical modelling of kinetics of heterogeneous reaction systems <i>Modelling of kinetics of reaction systems having a conversion function with inflexion</i>	126
<i>P. Dabić, P. Krolo, D. Barbir, M. Marguš</i> Priprava silika gela uz dodatak PVAL-a sol-gel metodom Preparation of silica gel with addition PVAL using sol-gel method	137
<i>M. Hrkovac, J. Prlić Kardum, A. Sander</i> Mogućnost dobivanja unimodalne raspodjele veličina kristala glicina The possibility of obtaining unimodal size distribution of glycine crystals	144
<i>V. Martinac, M. Labor, J. Jakić</i> Efficiency of the rinsing agent on the reduction of B ₂ O ₃ mass fraction in magnesium oxide from seawater	156
<i>I. Smoljko, S. Gudić, D. Jović</i> Anodno ponašanje aluminija u kloridnoj otopini Anodic behaviour of aluminium in Chloride solution	164
<i>N. Stipanelov Vrandečić, M. Jakić, I. Klarić, S. Muslim</i> Dinamička termogravimetrijska razgradnja mješavina PVC/PEO Dynamic thermogravimetric degradation of PVC/PEO blends	175
<i>L. Vrsalović, M. Kliškić, M. Tanfara</i> Investigation of corrosion behavior of AISI 316L steel in NaCl solution	187
<i>Prehrambena tehnologija i biotehnologija</i> <i>Food technology and biotechnology</i>	
<i>J. Babić, Đ. Ačkar, N. Drača, Lj. Jankuloski, M. Jankulovska, V. Brandić, D. Miličević</i> Kontrola kvalitete tijekom proizvodnje šećera iz šećerne repe i sirovog šećera iz šećerne trske Quality control during refining sugar from sugar beet and raw brown sugar from sugar cane	196
<i>J. Beganović, B. Kos, A. Leboš Pavunc, K. Habjanič, M. Ogorelec, J. Šušković</i> Influence of freeze-drying and microencapsulation on the functionality of probiotic strains in the intestinal tract	206
<i>M. Benković, I. Bauman</i> Characterization of flow properties of different flour types and mixtures used in bread making	219

<i>M. Brkljača, J. Giljanović</i> Determination of metals in olive oil by electrothermal atomic absorption spectrometry	230
<i>I. Budić-Leto, G. Zdunić, J. Gajdoš Kljusurić, I. Tomić-Potrebuješ, T. Lovrić</i> Effect of physicochemical variables on descriptive sensory attributes of the taste of <i>Prošek</i> wine	240
<i>F. Čačić, J. Lukinac, D. Magdić</i> Comparison of free and commercial software packages for engineering problem solving and education.....	247
<i>J. Frece, K. Markov, D. Čvek, D. Kovačević, I. Gobin, F. Delaš</i> <i>Lactobacillus plantarum</i> 1K from “SLAVONSKI KULEN” as natural probiotic starter culture	254
<i>J. Frece, K. Markov, D. Čvek, D. Kovačević, L. Duraković, F. Delaš</i> Autochthonous functional starter cultures and mycotoxins in “SLAVONSKI KULEN” ...	263
<i>M. Gugić, I. Jerković, Z. Marijanović, M. Šarolić</i> Biološka vrijednost i kvaliteta ulja masline sorte <i>Oblica</i> u odnosu na područje uzgoja Biological value and quality of olive oil made from the sort <i>Oblica</i> in relation to farming area	274
<i>K. Habschied, V. Krstanović, I. Šimunović, M. Tišma, V. Slačanac, N. Velić</i> Study on spent brewer's yeast hydrolysis by acid	290
<i>D. Horvat, Ž. Kurtanjek, G. Drezner, G. Šimić</i> Chemometric analysis of wheat cultivars.....	294
<i>L. Jakobek, M. Šeruga, P. Krivak</i> The influence of interactions among phenolic compounds from chokeberry on the antiradical activity of chokeberry	302
<i>V. Jocić, A. Škalić, K. Buntak</i> Technical criteria for the development of calibrations for moisture meters.....	311
<i>D. Kenjerić, M. L. Mandić, Lj. Primorac, F. Čačić</i> Flavonoids in Croatian Chestnut (<i>Castanea sativa</i>) honey	319
<i>M. Kopjar, J. Hribar, M. Simčić, E. Zlatič, V. Piližota</i> Influence of trehalose addition on selected aroma compounds in strawberry cream fillings	326
<i>D. Kovačević, K. Mastanjević, K. Suman</i> Cryoprotective effect of maltose on chicken myofibrillar proteins (CMP).....	336

<i>I. Ljubičić, A. Legac, A. Belščak-Cvitanović, D. Horžić, F. Dujmić, D. Komes</i> Bioactive potential of herbal infusions prepared from traditional medicinal plants	343
<i>T. Moslavac, A. Pozderović, A. Pichler, K. Volmut</i> Komparativna studija oksidacijske stabilnosti jestivih ulja sa Schaal oven testom i Rancimat metodom Comparative studies of oxidative stability of edible oils by Schaal oven test and the Rancimat method	353
<i>J. Mrvčić, O. Hrsto, D. Stanzer, S. Grba, V. Stehlik-Tomas</i> Proizvodnja i primjena bakterijskih egzopolisaharida u pekarstvu Production and application of bacterial exopolysaccharides in bread-making	361
<i>I. Mujić, M. Radojković, S. Vidović, Z. Zeković, Ž. Lepojević</i> Antioxidant properties of various solvent extracts of mulberry leaves	372
<i>N. Nedić Tiban, V. Piližota, I. Rendić</i> Shelf-life of fresh-cut pears processed after harvest and storage in controlled atmosphere	380
<i>A. Pozderović, T. Moslavac, A. Pichler, K. Paragović</i> Reološka svojstva modelnih otopina saharoze, pektina i celuloze kod niskih temperatura Rheological properties of sucrose model solutions with pectin and cellulose at low temperatures	389
<i>A. Pozderović, T. Moslavac, A. Pichler, K. Paragović</i> Utjecaj dodatka pektina na reološka svojstva kaše jabuke pri niskim temperaturama Influence of pectin addition on rheological properties of apple puree at low temperatures	398
<i>Lj. Primorac, I. Flanjak, M. Cvijetić, Z. Đapić</i> Electrical conductivity and ash content of selected honey types	406
<i>V. Slačanac, J. Hardi, V. Krstanović, Ž. Marketanović</i> Texture profile analysis of artisanal Croatian ewe's hard cheeses	412
<i>S. Škrabal, D. Šubarić, B. Miličević, D. Ačkar, J. Babić, R. Miličević</i> Utjecaj mlijeka u prahu i uvjeta čuvanja na stabilnost čokolada Influence of milk powder and storage conditions on stability of chocolates	418
<i>D. Valinger, J. Gajdoš Kljusurić, D. Kovačević, Ž. Kurtanjek</i> Application of NIR spectroscopy for monitoring quality of surimi	431

Kemija u poljoprivredi i šumarstvu
Chemistry in agriculture and forestry

A. Antonović, V. Jambreković, J. Ištvančić, N. Španić
Liquefied wood – potential application in wood industry..... 439

B. Svitlica, J. Čosić, J. Mesić
Utjecaj genotipa kukuruza na produkciju DON-a i fumonizina
Influence of maize genotypes on the production of DON-a and fumonisin..... 454

A. Špehar, M. Ostović, D. Milić, S. Kalambura
Effect of natural zeolite on total nitrogen concentration in pig slurry..... 463

Zaštita okoliša
Environmental protection

Z. Kuveždić, S. Radojević Lacković, M. Habuda-Stanić
Zbrinjavanje i obrada otpadnih voda grada Vinkovaca
Disposal and treatment of waste water in Vinkovci..... 466

S. Ozimec, M. Sikora, A. Opačak, T. Florijančić, Z. Puškadija, I. Bošković, D. Jelkić
Lišajevi – bioindikator kakvoće zraka u gradu Osijeku
Lichens – bioindicators of air quality in the city of Osijek..... 474

Ž. Romić, B. Kalajdžić, M. Habuda-Stanić, D. Pichler, M. Kuleš
Uspješnost uklanjanja arsena oksidacijskim postupcima pri preradi
podzemne vode u Vodovodu Osijek
The efficiency of arsenic removal using oxidation processes in the
well water treatment in Vodovod-Osijek..... 481

V. Rožac, L. Benčina
Voda donosi život
Water brings life..... 489

M. Šućur, R. Pinto
Environmental management in Croatia: challenges for small business..... 503

N. Vukojević Medvidović, S. Maletić, J. Perić, M. Trgo, M. Ugrina
Zinc removal from aqueous solutions by precipitation and
coagulation/flocculation..... 512

Authors index..... 521

Sponsors..... 524

Emerging technologies and their perspectives in food industry

UDC: 664.8.03 : 338.45

J. Hribar^{*}, T. Požrl, R. Vidrih

University of Ljubljana, Biotechnical faculty, Jamnikarjeva 101, 1000 Ljubljana, Slovenia

Summary

The food industry is currently interested in a variety of novel production and processing technologies that may result in economical and improved quality products. Some alternative technologies regarding fruit and vegetable storing and preservation are discussed. Preharvest approach to control ripening and harvest date is to apply either aminoethoxy vinyl glycin or a special formulation of 1-methyl cyclopropen (1-MCP). In order to more precisely control the storage life of fruits and vegetables, the post-harvest application of 1-MCP or dynamic atmosphere seems promising tool to control postharvest life of fruits. In fruit storing dynamic atmosphere may control some physiological diseases in a biological way thus preventing the application of phytochemicals. Enhancing microbial safety without compromising the nutritional and sensory characteristics of foods presents a big challenge in food industry. Due to the above-mentioned facts, there is an increasing interest in new non-thermal innovative technologies that rely on physical processes. The emerging technologies include ultrasound, high pressure processing (HPP), pulsed electric fields (PEF) and low-temperature plasmas (LTP). Combining two or more emerging technologies in a hurdle technology can potentially enhance the overall quality of minimally processed foods. Value-added food ingredients with positive biological properties have attracted great attention in recent years due to their potential applications in functional foods and nutraceuticals. While biological properties of some ingredients can be inactivated during conventional heat processing, some of the emerging non-thermal processing technologies, including HPP and PEF, offer a potential alternative to the existing heat preservation processes without compromising biological properties. The review also deals with aspects related to radiation processing of food, oscillating magnetic field, nano composite materials in food processing and biopolymers for food packaging. The fact that nowadays consumer is a key protagonist, food industry must be vigilant in their knowledge of consumer attitudes toward these processes in order to avoid unexpected failure of these products upon market introduction.

Keywords: high pressure processing, pulsed electric fields, low temperature plasma, oscillating magnetic fields, irradiation

*Janez.Hribar@bf.uni-lj.si

Introduction

Cooking, blanching and freezing are traditional food processing procedures familiar to consumers because they apply them in their own households. Food preservation by means of thermal treatments is a well known and old technique for reducing the microbial counts of food. Thermal treatments are adapted to fragile balance between overheating (diminish the foods sensory properties) and underheating which leads to unsafe food products. Heat treatment often imparts sensory properties of food resulting in cooked-like taste and aroma. On the other hand increased temperature affects negatively nutritional quality of food products. Nowadays consumer is a key protagonist in food chain. Consumers orientation is toward nutritious, fresh-like food products with high sensory quality and an extended shelf life. Due to the above mentioned facts, non-thermal processing alternatives have been proposed. Modern food technology deals with further development of traditional methods e.g. high-temperature short time heating or vacuum cooking, and on the other hand with procedures developed in other different industry branches that have been adapted to food processing e.g. micro-wave technology, high pressure-treatment, pulsed electric fields, low temperature plasma, oscillating magnetic field etc. The consumers response toward new technologies is rather sceptical mostly due to ionising radiation. Consumers usually consider the therm minimally processed as connected to the unsafe food. The new technologies not only enable food preservation, but they also focus on quality attributes.

Special attention is given to non-thermal 'cold' procedures that are supposed to inactivate undesirable microorganisms without damage to nutritional and sensory properties that usually result from thermal treatments. In the following, the principles of new physical and chemical procedures that are under development or already in use are described.

New technologies in fresh fruit: 1-aminocyclopropane (1-MCP) and dynamic atmosphere

Taking into consideration the post-harvest factors, most efforts have been dedicated to reducing the quantitative losses and maintenance of the appearance of fruit and vegetables. Ethylene is one of several plant-growth regulators that affect the growth and developmental processes, including ripening and senescence. The blocking of ethylene synthesis or perception with the aim of extending the shelf-life results in a lower production of aroma compounds (Fellman et al., 2000). According to Defilippi et al. (2005), the enzyme alcohol acyltransferase is under ethylene regulation and is involved in ester formation.

Of the ethylene inhibitors, 1-methylcyclopropene (1-MCP) is widely used on ornamental plants and edible horticultural products. It provides the potential to maintain fruit and vegetable quality after harvest. 1-MCP is believed to interact with ethylene receptors, and to thereby prevent ethylene-dependent

responses (Sisler and Serek, 1997). 1-MCP dramatically inhibits the ripening of apples, the extent of its inhibition being related to cultivar, storage type and length of storage (Fan and Mattheis, 1999; Defilippi et al., 2004). Inhibition by 1-MCP results in reductions in the internal ethylene concentrations, respiration and softening rate. Apples treated with 1-MCP are firmer, maintain a greener ground colour, and preserve better acidity, as compared to control fruit.

For the negative effects of 1-MCP, these are focused on flavour, which is usually poor in apples treated with 1-MCP. Numerous studies (Saftner et al., 2003; Fan and Mattheis, 1999; Fan et al., 2001) have indicated reduced production of aroma volatiles by the fruit in 1-MCP-treated apples, compared to untreated apples stored under similar conditions.

To overcome that shortage of 1-MCP, experiments with so called dynamic atmosphere proved that its implementation have similar effects on fruit physiology as 1-MCP with the addition that synthesis of aroma compounds are not so severely reduced as compared to 1-MCP. Dynamic atmosphere adjusts the O₂ concentration according to fruit physiological stage; from the beginning of storage O₂ concentration is kept at very low concentration (cca. 0.5 %) till anaerobic metabolism takes place. The most common sensor to detect the appearance of anaerobic metabolism is chlorophyll fluorescence detector. Gasser et al. (2008a, 2008b) showed that fluorescence is highly correlated in response to low-oxygen stress in apples. When detector recognizes an increased fluorescence due to anaerobic metabolism the O₂ concentration is adjusted to a higher level (1.2 %) for a certain period than it is lowered again to 0.5 % and maintained according to physiological stage of fruit. The dynamic atmosphere resulted in greater ester emission after storage compared with apples stored in static controlled atmosphere conditions (Mattheis et al., 1998). Beside better recuperation of aroma compounds, dynamic atmosphere also proved to reduce the appearance of physiological disorder scald. Usage of dynamic atmosphere is thus recommended for biologically produced apples since no chemicals are to be used during storage (DeLong et al., 2004). New application of 1-MCP includes a preharvest preparation under brand name ‘Harvista’ with the intention to control ripening in orchard. Another preharvest application regards Aminoethoxyvinylglycine HCl (AVG), a substance that similarly inhibits on-tree ripening of climacteric fruits.

High pressure processing (HPP)

As stated before, consumers are key protagonists in food chain, so consumer judge food quality based on its sensory and nutritional characteristics (texture, flavour, aroma, colour, energy value, vitamins and antioxidants). Some consumer’s attitudes and shelf life determine an individual’s preference for

specific food. Recently an increased sale of fresh and chilled food is reported (Hogan et al., 2005). An increasing demand in fresh cut products requires by the food industry to implement techniques to keep the food fresher for longer, longer shelf-life and assuring food safety. Food safety and shelf life is depends on microbial infestation and other phenomena such as different biochemical reactions, enzymatic reactions and structural changes that all influence consumers perception of food quality. The colour, flavour, texture, and the nutritional value of fresh-cut fruit and vegetable products are factors critical to consumer acceptance and the success of these products (Barrett et al., 2010). Conventional thermal processes are effective in preventing microbial spoilage but may often cause off-flavours, changes in colour and texture as well as destruction of vitamins.

HPP is considered to successfully inactivate all harmful microorganisms without having detrimental impact on food quality (Smelt, 1998).

The texture of fruit and vegetable depends on the structure of cell wall middle lamella which is undergoing changes during ripening as a consequence of enzymes that hydrolyse it. During processing, HPP disrupt tissue morphology, cell organelles and cell membranes.

Fresh-cut products are wounded tissues, and consequently more sensitive to deteriorative changes as compared to intact fruit and vegetables. The processes like peeling, coring, chopping, slicing, dicing or shredding cut through cells and release cell contents at the sites of wounding. For both fruit and vegetables, wounding and mechanical injury result in increased rates of respiration and production of ethylene (Agar et al., 1999; Escalona et al., 2003).

Perera et al. (2010) compared the sensory and chemical analyses of vacuum packed apple cubes (combined with pineapple juice) subjected to HPP treatment. During the 4 weeks storage in bag visible colour changes were not observed. Texture and ΔE after 5 h air exposure were significantly affected by the apple variety, HPP time and percentage of pineapple juice used. The combined treatment significantly reduced residual polyphenol oxidase (PPO) activity while pectin methyl esterase activity (PME) was not affected. Pineapple juice in combination with HPP could be used as a natural preservation system for minimally processed apples (Perera et al., 2010).

In carrots, textural changes were primarily caused by loss of turgidity induced by rapid compression and decompression (Araya et al., 2007). They observed higher textural losses at pressures above 300 MPa but noted the textural losses may be reduced by the activation of PME. The role of PME in preserving texture was also confirmed by Villarreal-Alba et al. (2004) who found positive correlation of PMA activity and texture of pepper. While most of the enzymes denature during HPP procedure, PMA remains tolerant at commonly used HPP pressures (Fachin et al., 2004). Colour of HPP processed foods is generally stable if temperature does not exceed 50 °C (Krebbes et al., 2003), but the temperatures above 50 °C are detrimental for chlorophyll (Van Loey et al., 1998).

Since anthocyanins are primary constituents of many fruits and vegetable species, their stability has a pronounced impact on overall colour of products. Enzymes like β -glucosidase, peroxidase and polyphenoloxidase are involved in degenerative reactions of anthocyanins. Treatment at 800 MPa is sufficient to inactivate all 3 enzymes and render colour stability (Gimenez et al., 2001; Garcia-Palazon et al., 2004; Suthanthangjai et al., 2005).

With regard to flavour, HPP has no or very little effect. The highest flavour stability was found when fruit was treated with higher pressures (Lambadarios and Zabetakis, 2002). Most of fruit products retain fresh-like flavour for an extended period at optimal storage conditions as compared to conventional thermal treatments. Storage temperature seems to play an important role to preserve the quality of HPP products. According to Baxter et al. (2005) orange juice produced by HPP was acceptable to consumers for up to 12 weeks at temperatures below 10 °C, but its flavour deteriorates rapidly if stored at 30 °C. In preliminary experiments with meat, HPP proved to extend the shelf life of meat. HPP treated meat was of similar quality as compared to untreated controls.

Pulsed electric fields (PEF)

Pulsed electric field (PEF) is a novel method to preserve food on the basis to inhibit microorganisms without causing significant changes of colour, flavour, taste and nutrients. A number of products like fruit and vegetable juices, soups as well as milk and yoghurt based products (Min et al., 2007). A high intensity electric field is generated between two electrodes and it passes through food. To attain non thermal treatment a very short pulse width of treatment time is applied. Mechanism by which PEF inhibits microorganisms basis on structural changes of cell membrane which lead to ion leakage, losses of metabolites and protein releases (Min et al., 2007). The electric potential causes the electroporation of membrane and consequent irreversible pore formation and destruction of the semi-permeable barrier of the cell membrane (Aronsson et al., 2005). Electric field intensity, greater than a critical trans-membrane potential of 1 V is required. As reported by Wan et al. (2009), yeast cells are more sensitive than bacterial cells and that Gram-negative cells are more sensitive than Gram-positive cells. Among environmental factors, lowering the conductivity of medium increases the degree of microbial inactivation (Wouters et al., 1999). With regard to mediums pH, its effect remains inconclusive. Geveke and Kozempel (2003) reported an increased inactivation of *Listeria spp.* with lower pH values, however Garcia et al. (2005) reported that sensitivity of microorganisms to PEF treatment is dependent on the target microflora. Certain food components like Ca^{2+} and Mg^{2+} (Hulsheger et al., 1981) or higher fat content in milk (Grahl and Markl, 1996) in the medium cause increased resistance to PEF treatment. On the other hand, synergistic interactions between PEF and increased non-lethal temperatures have been reported (Craven et al., 2008; Shamsi et al., 2008).

Application of moderate PEF may be useful to improve extractability of some bioactive compounds from different food matrices (Soliva-Fortuny et al., 2009). On the other hand the effect of PEF exhibited less change in the content of vitamins and fatty acids as compared to conventional heat treatment. Similar results are reported for sensory characteristics of food that was processed using PEF. In a study panellists evaluated sensory properties of orange juice that was unprocessed, thermally processed or PEF processed (Min et al., 2003). Although PEF processed orange juice was not found to be as good as freshly squeezed, it differed significantly from thermally processed in terms of flavour and overall acceptability.

Low-temperature plasmas (LTP)

Fluorescent or neon light is the most common artificially produced plasma. Plasma is matter that contains ionised gas with a net neutral charge and is often referred to as the fourth stage of matter (Wan et al., 2009). High temperature plasma of up to thousands degrees Celsius has been used in industrial processes including microelectronics and automotive industry. Low temperature plasmas were developed recently and were successfully applied for the sterilisation of the surfaces of bio-medical materials and devices (Rossi et al., 2006; Kogelschatz, 2007). Thermal, electric and magnetic fields as well as radio or microwave frequencies are applied to convert a neutral gas to plasma. Plasma products include electrons, ions, radicals and radiation of various wavelengths including that in UV range (Wan et al., 2009). The effectiveness of plasma to inactivate microorganisms depends on the equipment design, and operating conditions like gas type, flow rate and pressure. Electric fields are the most commonly used source to generate plasmas for technological applications.

Radiation processing of food

Application of ionizing energy in food industry is a well-known method aimed at improving the safety of various foods by reducing or eliminating food borne pathogens (O'Bryan et al., 2008) while maintaining nutritional and sensory properties of food. Recently, there has been an increasing recognition of the importance of irradiation in the food industry; currently, more than 50 countries have given approval for over 60 foodstuffs to be irradiated for local consumption and/or for export. The USA, South Africa, the Netherlands, Thailand, and France are the leaders in using the food irradiation technology (Stefanova et al., 2010). Forty different countries are using the food irradiation technology (Kume et al., 2009).

According to Stefanova et al. (2010) the food irradiation technology is primarily used to:

- extend the shelf-life of foods as a consequence of reduction in the spoilage microflora and the resistance of microorganisms (or reduction of microbial loading) as well
- reduce microorganisms and prevent food borne diseases by reduction of food-poisoning organisms
- delay ripening of certain fruits
- inhibit the sprouting of vegetables (as potatoes and onions)
- prevent insect infestation in grains and citrus fruits

Advantages of Food Irradiation

Among the potential advantages of food irradiation, authors (Farkas, 2006); O'Bryan et al., 2008; Stefanova et al., 2010) list following advantages:

1. Improved sanitation:
 - an effective means in controlling food borne spoilage microorganisms which can cause illness (and even deaths), outbreaks, and recalls. Inactivation of pathogenic microorganisms is the most essential advantage of irradiation technology for human health. This technique is successfully used to preserve meats, ready-to-eat meat products, seafood, fruits, vegetables, cereal grains, and legumes in raw and frozen state.
 - improvement of the hygienic quality of the foods; meats and seafood can be decontaminated of bacteria and parasites; cereal grains, legumes, fruits, and dried fish of insects; spices and vegetable seasonings of bacteria and insects.
2. Broad-spectrum quarantine treatment:
 - irradiation is the only quarantine treatment method used as a pest control measure for infected plants, especially in subtropical and tropical regions.
 - since chemical fumigation using ethylene di-bromide, methyl bromide, and ethyl oxide for the control of insects has been banned due to their negative impact on human health and the environment, irradiation treatment offers a good alternative in reducing post-harvest losses.
3. Conventional preservation techniques impair nutritional value and sensory quality of foods; insignificant losses of some vitamins and changes in colour, odour, and texture are reported for this novel technique.
4. Under prescribed conditions, radiation (gamma rays, X-rays, and e-beam) does not produce any 'radioactivity', what many people do not well realize.

5. Foods are treated after packaging in the fresh or frozen state; when treated in fresh state, the shelf life is extended due to the complete inactivation of microorganisms and pests.
6. The irradiation facilities are safe to workers, environment and the public around.

Disadvantages of Food Irradiation

They are related to the following issues:

1. In some food products irradiation can lead to chemical changes that can affect the food's sensory properties, resulting in the appearance of off-flavour (milk).
2. Radiation treatment of some fresh fruits and vegetable may cause softening as a result from damaging of the wall cells (avocados, pears, cantaloupes, and plums).
3. High-dose radiation of meat products can induce deterioration of food sensory properties (mainly producing unpleasant off-flavour and change in colour).
4. Some water and fat soluble vitamins are degraded as a result of radiation treatment.
5. Toxic radiolytic products, in particular unique radiolytic 2-alkylcyclobutanones may be formed as a result of radiation.
6. Radiation of high fat food results in formation of oxidation degradation products such as aldehydes, ketones, alcohols, etc.
7. It cannot eliminate food-borne viruses and prions.
8. High capital cost.
9. Strong public and industry resistance to “nuclear technology”.

Detection of Irradiated Food

Irradiated food must be labelled to indicate that the food or a particular ingredient has been irradiated. Reliable analytical detection methods are required in order to differentiate between irradiated and non-irradiated food products. As described by (Stefanova et al., 2010), a numerous methods based on physical, chemical, biological, and microbiological changes appearing in irradiated foods have been studied.

As a conclusion, food irradiation is still regarded with suspicion within many European countries while more support for the application of irradiation is found in USA. Food radiation is a promising tool to ensure safety and quality of food, thus successfully replacing the conventional preservation methods. It successfully reduces microbial load and use of fumigants as well as other

chemical preservatives. With the exception of some food, radiation does not alter sensory and chemical properties while maintaining good shelf-life.

Biopolymers for food packaging

Nowadays non-biodegradable petrochemical-based packaging materials represent a major source of waste. The production of synthetic plastics amounts to 200 million tons per year (Zhang et al., 2002). The greatest share represents plastic for packaging with 12 million tons. Consumers are becoming more and more concerned about environmental waste problems and hence interested in renewable resources to produce edible or biodegradable packaging material. Various renewable biopolymers based on polysaccharides, proteins and lipids with plant or animal origin are being explored with the purpose to replace non biodegradable packaging material. The main purpose of packaging material is to create physical barrier, establish proper storage conditions within package and render satisfactory shelf life. Mechanical properties, gas and vapour transmission are among the most important factors that maintains the quality during storage, handling and shelf life. After opening the non-degradable packaging material becomes an unnecessary waste and should be treated according to legislation. The advantage of bio-degradable films is that they degrade without causing environmental problems. Beside being biodegradable and renewable, they are also edible and serve as a carrier of some active substances like antioxidants, antifungals, colours and other additives (Rhim and Ng, 2007). Natural biopolymers represent good barrier for oxygen but relatively weak barrier for vapour due to their hydrophilic nature (Gontard et al., 1994).

Natural biopolymer-based films have been reviewed comprehensively by Rhim and Ng 2007, Sztuka and Kolodziejska 2008. High molecular weight polymers have sufficient cohesive strength to produce suitable film structure. Many natural biopolymers can be used to prepare the films among most widely used being polysaccharides, proteins, lipids and their composites.

Polysaccharide films include starch and cellulose derivatives, alginate, pectin, carrageenan and various gums. The main limitation of polysaccharide films is low elasticity. Protein films are made of proteins through condensation of amino acids. Since various combinations of amino acid repeat units are significant for different plant species, amino acid combination thus influence film properties. In general protein films exhibit good ability to form networks, plasticity and elasticity (Rhim and Ng, 2007). Casein, corn zein and gelatine are among the most important ingredients to produce film coatings. Among novel materials, wheat gluten, rice bran, cotton seed protein, collagen, fish myofibrillar protein, keratin and egg white have been extensively studied to produce protein films (Krochta and DeMulderJohnston, 1997; Hernandez-Munoz et al., 2003). Among lipid films, waxes of different origin like bees wax, carnauba wax, triglycerides, fatty acids, fatty alcohols, various resins and sucrose fatty acid esters are

commonly used. The main advantage of these films is high barrier properties, but high oxygen permeability. Another drawback concerns the sensory properties because some lipids oxidise easily and produce rancid like taste. In order to modify physical properties of bio-polymers, various additives are combined into polymer. Plasticizers are most widely used additives that increase flexibility and processability of bio-polymer (Sothornvit et al., 2002).

The use of nanocomposites is known to modify film properties of biopolymers. Minerals fillers like clay and silica are incorporated into film preparation in the range of 10 to 50 % to improve the performance. Polymer-clay nanocomposites have caught particular attention because they exhibited large-scale improvement as compared to pure polymers. Nanocomposites are thus composed of polymer (polysaccharide, protein or lipid) and clay nano-scale fillers (Lagaly, 1999). Biopolymers need to be modified to make them suitable packaging material. Bio nanocomposites thus have very strong future prospects. Much research work is still ahead to meet the requirements of food industry toward safe food.

Oscillating magnetic field

Magnetic field is defined as the region in which a magnetic material is able to magnetise particles. It can be static or oscillating according to magnetic intensity which may be constant with time or not (Palmieri et al., 1999). Magnetic field is described by field intensity, measured in ampere/meter and magnetic flux density defined as the number of lines of force per unit area and measured in tesla (T). Properties of the product being magnetised in particular the electrical resistance that has to be as high as possible determine the induced magnetic field intensity (Palmieri et al., 1999). Most foods exhibit electric resistance greater than 25 Ω /cm and may be treated by high magnetic oscillating fields. Some packed liquid foods like milk, dairy products, juices, etc. may be successfully treated with oscillating magnetic field with a frequency between 5 and 550 kHz for 25 μ s to 10 ms.

Exposure to a magnetic field may stimulate or inhibit the growth and reproduction of microorganisms. Very high intensity magnetic field of 5 to 50 T is required and frequency of 5 to 500 kHz generally reduces the number of microorganisms by at least 2-log cycles (Hoffman, 1985). The inactivation mechanism of microorganisms by means of magnetic field has not been fully explained; it is hypothesised that it alters the growth and reproduction of microorganisms by both genetic and biochemical pathways. As reported by Frankel and Liburdy (1995), high intensity magnetic fields can affect membrane fluidity and other properties of cells. Inconsistent results of other inactivation studies, however, make it impossible to clearly state the microbial inactivation efficiency of magnetic field or to make any predictions about its effects on microbial populations. Further studies are needed to establish the effect of magnetic field on enzymes and resistant bacteria.

The technique of oscillating magnetic fields is safe for the operators; high magnetic fields exist only in the coil and the nearest surroundings but they reach values absolutely harmless to the humans at the distance of 2 m.

Process is performed at atmospheric pressure and room temperature and results in a temperature increase not higher than 5 °C. Because of minimal increase of temperature, a good retention of nutritional and sensory properties is assured. Regarding packaging material, any material is suitable with the exception of packaging material containing metal.

Conclusions

New technologies applied in food industry are friendlier to the environment and may contribute to nutritional and sensory value of food. However, foods processed with emerging technologies have different sensory properties as compared to conventionally processed food. The negative impact of new technology may be a source of consumer concern. A typical example of such concern is the controversial application of genetic engineering or food irradiation. Although most of emerging technologies are different in their concepts and definitions, they may share the same novelty to consumers and all may be considered non-conventional technologies. Various factors are likely to influence consumer reactions to novel products. Consumer risk perceptions associated with any potential food hazard are driven by psychological constructs which are very different to the technical estimates provided by experts. It is important to address issues of consumer acceptance during product development rather than try to develop public relations campaigns to force consumer acceptance once novel products are brought to marketplace.

References

- Agar I.T., Massantini R., Hess-Pierce B., Kader A.A. (1999): Postharvest CO₂ and ethylene production and quality maintenance of fresh-cut kiwifruit slices, *Journal of Food Science* 64 (3), 433-440.
- Araya X.I.T., Hendrickx M., Verlinden B.E., Van Buggenhout S., Smale N.J., Stewart C., Mawson A.J. (2007): Understanding texture changes of high pressure processed fresh carrots: A microstructural and biochemical approach, *Journal of Food Engineering* 80 (3), 873-884.
- Aronsson K., Ronner U., Borch E. (2005): Inactivation of *Escherichia coli*, *Listeria innocua* and *Saccharomyces cerevisiae* in relation to membrane permeabilization and subsequent leakage of intracellular compounds due to pulsed electric field processing, *International Journal of Food Microbiology* 99 (1), 19-32.
- Barrett D.M., Beaulieu J.C., Shewfelt R. (2010): Color, Flavor, Texture, and Nutritional Quality of Fresh-Cut Fruits and Vegetables: Desirable Levels, Instrumental and Sensory Measurement, and the Effects of Processing, *Critical Reviews in Food Science and Nutrition* 50 (5), 369-389.

- Baxter I.A., Easton K., Schneebeli K., Whitfield F.B. (2005): High pressure processing of Australian navel orange juices: Sensory analysis and volatile flavor profiling, *Innovative Food Science and Emerging Technologies* 6 (4), 372-387.
- Craven H.M., Swiergon P., Ng S., Midgely J., Versteeg C., Coventry M.J., Wan J. (2008): Evaluation of pulsed electric field and minimal heat treatments for inactivation of pseudomonads and enhancement of milk shelf-life, *Innovative Food Science and Emerging Technologies* 9 (2), 211-216.
- Defilippi B.G., Dandekar A.M., Kader A.A. (2004): Impact of suppression of ethylene action or biosynthesis on flavor metabolites in apple (*Malus domestica* Borkh) fruits, *Journal of Agricultural and Food Chemistry* 52 (18), 5694-5701.
- Defilippi B.G., Dandekar A.M., Kader A.A. (2005): Relationship of ethylene biosynthesis to volatile production, related enzymes, and precursor availability in apple peel and flesh tissues, *Journal of Agricultural and Food Chemistry* 53 (8), 3133-3141.
- DeLong J.M., Prange R.K., Leyte J.C., Harrison P.A. (2004): A new technology that determines low-oxygen thresholds in controlled-atmosphere-stored apples, *Horttechnology* 14 (2), 262-266.
- Escalona V.H., Aguayo E., Artes F. (2003): Quality and physiological changes of fresh-cut kohlrabi, *Hortscience* 38 (6), 1148-1152.
- Fachin D., Smout C., Verlent I., Nguyen B.L., Van Loey A.M., Hendrickx M.E. (2004): Inactivation kinetics of purified tomato polygalacturonase by thermal and high-pressure processing, *Journal of Agricultural and Food Chemistry* 52 (9), 2697-2703.
- Fan X.T., Mattheis J.P. (1999): Impact of 1-methylcyclopropene and methyl jasmonate on apple volatile production, *Journal of Agricultural and Food Chemistry* 47 (7), 2847-2853.
- Farkas J. (2006). Irradiation for better foods, *Trends in Food Science and Technology* 17 (4), 148-152.
- Fellman J.K., Miller T.W., Mattinson D.S., Mattheis J.P. (2000): Factors that influence biosynthesis of volatile flavor compounds in apple fruits, *Hortscience* 35 (6), 1026-1033.
- Frankel, R. B., Liburdy, R. P. (1995): Biological effects of static magnetic fields. In *Handbook of Biological Effects of Electromagnetic Fields*. Polk, C. and Postow, E. (Ed). 2nd Ed. CRC Press. Boca Raton, FL
- Garcia-Palazon A., Suthanthangjai W., Kajda P., Zabetakis L. (2004): The effects of high hydrostatic pressure on beta-glucosidase, peroxidase and polyphenoloxidase in red raspberry (*Rubus idaeus*) and strawberry (*Fragaria x ananassa*), *Food Chemistry* 88 (1), 7-10.
- Garcia D., Gomez N., Manas P., Condon S., Raso J., Pagan R. (2005): Occurrence of sublethal injury after pulsed electric fields depending on the micro-organism, the treatment medium pH and the intensity of the treatment investigated, *Journal of Applied Microbiology* 99 (1), 94-104.
- Gasser F., Eppler T., Naunheim W., Gabioud S., Hohn E. (2008a): Control of the critical oxygen level during dynamic CA storage of apples, *Agrarforschung* 15 (2), 98-103.
- Gasser F., Eppler T., Naunheim W., Gabioud S., Höhn E. (2008b): Control of the critical oxygen level during dynamic CA storage of apples by monitoring respiration as well as chlorophyll fluorescence, *Acta Horticulturae* 796, 69-76.
- Geveke D.J., Kozempel M.F. (2003): Pulsed electric field effects on bacteria and yeast cells, *Journal of Food Processing and Preservation* 27 (1), 65-72.

- Jimenez J., Kajda P., Margomenou L., Piggott J.R., Zabetakis I. (2001): A study on the colour and sensory attributes of high-hydrostatic-pressure jams as compared with traditional jams, *Journal of the Science of Food and Agriculture* 81 (13), 1228-1234.
- Gontard N., Duchez C., Cuq J.L., Guilbert S. (1994): Edible composite films of wheat gluten and lipids - water-vapor permeability and other physical-properties, *International Journal of Food Science and Technology* 29 (1), 39-50.
- Grahl T., Markl H. (1996): Killing of microorganisms by pulsed electric fields, *Applied Microbiology and Biotechnology* 45 (1-2), 148-157.
- Hernandez-Munoz P., Kanavouras A., Ng P.K.W., Gavara R. (2003): Development and characterization of biodegradable films made from wheat gluten protein fractions, *Journal of Agricultural and Food Chemistry* 51 (26), 7647-7654.
- Hofmann, G.A. (1985): Deactivation of microorganisms by an oscillating magnetic field. U.S. Patent 4,524,079.
- Hogan E., Kelly A.L., Sun D.W. (2005): High pressure processing of foods: An Overview. Emerging technologies for food processing, D.W. Sun. London, UK, Elsevier, 3-32.
- Hulsheger H., Potel J., Niemann E.G. (1981): Killing of bacteria with electric pulses of high-field strength, *Radiation and Environmental Biophysics* 20 (1), 53-65.
- Kogelschatz U. (2007): Twenty years of Hakone symposia: From basic plasma chemistry to billion dollar markets, *Plasma Processes and Polymers* 4 (7-8), 678-681.
- Krebbes B., Matser A., Hoogerverf S., Moezelaar R., Tomassen M., Van den Berg R.W. (2003): Combined high-pressure and thermal treatments for processing of tomato puree: Evaluation of microbial inactivation and quality parameters, *Innovative Food Science and Emerging Technologies* 4 (4), 377-385.
- Krochta J.M., DeMulderJohnston C. (1997): Edible and biodegradable polymer films: Challenges and opportunities, *Food Technology* 51 (2), 61-74.
- Lagaly G. (1999): Introduction: from clay mineral-polymer interactions to clay mineral-polymer nanocomposites, *Applied Clay Science* 15 (1-2), 1-9.
- Lambadarios E., Zabetakis I. (2002): Does high hydrostatic pressure affect fruit esters? Lebensmittel-Wissenschaft Und-Technologie, *Food Science and Technology* 35 (4), 362-366.
- Mattheis J.P., Buchanan D.A., Fellman J.K. (1998): Volatile compounds emitted by 'Gala' apples following dynamic atmosphere storage, *Journal of the American Society for Horticultural Science* 123 (3), 426-432.
- Min S., Evrendilek G.A., Zhang H.Q. (2007): Pulsed electric fields: Processing system, microbial and enzyme inhibition, and shelf life extension of foods. *IEEE Transactions on Plasma Science* 35 (1), 59-73.
- Min S., Jin Z.T., Min S.K., Yeom H., Zhang Q.H. (2003): Commercial-scale pulsed electric field processing of orange juice, *Journal of Food Science* 68 (4), 1265-1271.
- O'Bryan C.A., Crandall P.G., Ricke S.C., Olson D.G. (2008): Impact of irradiation on the safety and quality of poultry and meat products: A review, *Critical Reviews in Food Science and Nutrition* 48 (5), 442-457.
- Palmieri L., Cacace D., Dall'Aglio G. (1999): Non-thermal methods of food preservation based on electromagnetic energy, *Food Technology and Biotechnology* 37 (2), 145-149.
- Perera N., Gamage T.V., Wakeling L., Gamlath G.G.S., Versteeg C. (2010): Colour and texture of apples high pressure processed in pineapple juice, *Innovative Food Science and Emerging Technologies* 11 (1), 39-46.

- Rhim J.W., Ng P.K.W. (2007): Natural biopolymer-based nanocomposite films for packaging applications, *Critical Reviews in Food Science and Nutrition* 47 (4), 411-433.
- Rossi F., Kylian O., Hasiwa M. (2006): Decontamination of surfaces by low pressure plasma discharges, *Plasma Processes and Polymers* 3 (6-7), 431-442.
- Shamsi K., Versteeg C., Sherkat F., Wan J. (2008): Alkaline phosphatase and microbial inactivation by pulsed electric field in bovine milk, *Innovative Food Science and Emerging Technologies* 9 (2), 217-223.
- Smelt J. (1998): Recent advances in the microbiology of high pressure processing, *Trends in Food Science and Technology* 9 (4), 152-158.
- Soliva-Fortuny R., Balasa A., Knorr D., Martín-Belloso O. (2009): Effects of pulsed electric fields on bioactive compounds in foods: a review, *Trends in Food Science and Technology* 20 (11-12), 544-556.
- Sothornvit R., Reid D.S., Krochta J.M. (2002): Plasticizer effect on the glass transition temperature of beta-lactoglobulin films, *Transactions of the Asae* 45 (5), 1479-1484.
- Stefanova R., Vasilev N.V., Spassov S.L. (2010): Irradiation of Food, Current Legislation Framework, and Detection of Irradiated Foods, *Food Analytical Methods* 3 (3), 225-252.
- Suthanthangjai W., Kajda P., Zabetakis L. (2005): The effect of high hydrostatic pressure on the anthocyanins of raspberry (*Rubus idaeus*), *Food Chemistry* 90 (1-2), 193-197.
- Sztuka K., Kolodziejaska I. (2008): Edible films and surface coatings made of natural polymers for food packaging. Part II. Modifications, *Polimery* 53 (10), 725-729.
- Van Loey A., Ooms V., Weemaes C., Van den Broeck I., Ludikhuyze L., Indrawati, Denys S., Hendrickx M. (1998): Thermal and pressure-temperature degradation of chlorophyll in broccoli (*Brassica oleracea L italica*) juice: A kinetic study, *Journal of Agricultural and Food Chemistry* 46 (12), 5289-5294.
- Villarreal-Alba E.G., Contreras-Esquivel J.C., Aguilar-Gonzalez C.N., Reyes-Vega M.L. (2004): Pectinesterase activity and the texture of Jalapeno pepper, *European Food Research and Technology* 218 (2), 164-166.
- Wan J., Coventry J., Swiergon P., Sanguansri P., Versteeg C. (2009): Advances in innovative processing technologies for microbial inactivation and enhancement of food safety - pulsed electric field and low-temperature plasma, *Trends in Food Science and Technology* 20 (9), 414-424.
- Wouters P.C., Dutreux N., Smelt J., Lelieveld H.L.M. (1999): Effects of pulsed electric fields on inactivation kinetics of *Listeria innocua*, *Applied and Environmental Microbiology* 65 (12), 5364-5371.
- Zhang L.N., Ruan D., Gao S.J. (2002): Dissolution and regeneration of cellulose in NaOH/thiourea aqueous solution, *Journal of Polymer Science Part B-Polymer Physics* 40 (14), 1521-1529.

Towards sustainable food production *In memory to academian Dragutin Fleš (1921. – 2005.)*

UDC: 338.439

V. Piližota *

*University of Josip Juraj Strossmayer in Osijek, Faculty of Food Technology Osijek,
Franje Kuhača 20, 31000 Osijek, Croatia*

Summary

Sustainable development could be defined as meeting 'the needs of the present generations without compromising the ability of future generations in meeting their needs' (Baldvin, 2009). There are several related principles of sustainable food production, but probably the most central, is not to use resources faster than they renew. As the food is one of the most important human needs there is a need to pay attention to food production from all aspects among which the most important are food safety or healthy products, high nutritious food (to meet all consumers' nutritious demands), permanent high standard food supply, reduction in energy consumption, minimizing resource inputs, using renewable energy and packaging materials, whenever possible, as well as high standards in working environment and continuous employees' education.

Keywords: sustainability, sustainable food production, sustainable food chain

Introduction

Sustainable food system is one that provides healthy food to meet current food needs while maintaining healthy eco-systems that can also provide food for generations to come with minimal negative impact to the environment (APHA - American Public Health Association). Sustainability became a high priority issue in all areas of interest and activities of the human kind, and growing awareness of environmental issues is affecting our lifestyles. Because food is part of the lives of millions of consumers each day, all players in food chain have a critical responsibility to create positive environmental change. Given the central role of food supply and the emotional relationship that modern mankind still has to its food, sustainability is seen as a value which has to be maintained throughout food supply chains. The food chain sector is responsible for a large environmental impact at present. It is currently heavily dependant on non-renewable energy resources (fossil fuels) and on the use of chemicals for efficient production. Sustainability seeks to reduce energy costs and to protect the environment. Seeking to reduce energy costs and to protect the environment, companies are exploring “green” manufacturing practices (eco-friendly products,

* vlasta.pilizota@ptfos.hr

eco-friendly packaging, organic and fair treatment of employees and suppliers), installing technologies (energy-efficient equipment) to help to reduce energy usage and costs and sustainable/renewable packaging (reusing and less material) applications, or engineering innovative processing methods (Nachay, 2008).

Choosing raw materials that are sourced or produced in ways that minimally affect the environment is a step that companies can take to become “green”. If consumers continue to purchase products that are promoted as eco-friendly or sustainable, the companies will continue to produce more of these products as well as invest in corporate sustainable/environmental practices (Nachay, 2008). The complexity of modern food systems, also, invokes a variety of ethical implications which emerge from contrasts between ideals, perceptions and the conditions of technical processes within food systems, and the concerns connected to this (Zollitsch et al., 2007).

In the changing environment in which Europe’s agri-food industries must prosper, in the 21st century, new knowledge-based food systems are required that are profitable at all levels, are environmentally sustainable, can cope with emerging climate changes and that, in the circumstances now arising, are energy efficient.

Sustainable development

There are many definitions of sustainable development. One is well known as the Brundtland “Mantra”: “Development that meets the needs of the present without compromising the ability of future generations to meet their own needs”, emphasized in the report '**Our Common Future**', by former Norwegian Prime Minister Gro Harlem Brundtland (former Chair of the World Commission on Environment and Development), and also known as the **Brundtland Report**, from the United Nations World Commission on Environment and Development (WCED) that was published in 1987, and laid the groundwork for the convening of the 1992 Earth Summit and the adoption of Agenda 21, the Rio Declaration and to the establishment of the Commission on Sustainable Development.

An oft-quoted definition of sustainable development is defined in the report as: "*development that meets the needs of the present without compromising the ability of future generations to meet their own needs.*" In addition, key contributions of *Our Common Future* to the concept of sustainable development include the recognition that the many crises facing the planet are *interlocking crises* that are elements of a single crisis of the whole and of the vital need for the active participation of all sectors of society in consultation and decisions relating to sustainable development (Brundtland, 1987).

Also, another definition: "*Sustainability is an economic state where the demands placed upon the environment by people and commerce can be met without reducing the capacity of the environment to provide for future generations*" is given by Paul Hawken, an environmentalist, entrepreneur, journalist, and

author (Hawken, 1993). Hawken, believes that "*we need a design for business that will ensure that the industrial world as it is presently constituted ceases and is replaced with human-centered enterprises that are sustainable producers.*" Avoiding stormy rhetoric, Hawken thoughtfully reviews ecological theories and disasters and insists that "ecology offers a way to examine all present economic and resource activities from a biological rather than a monetary point of view." Calling for a restorative economy, he proposes rational, achievable goals: stop "accelerating the rate that we draw down capacity"; refrain from "buying or degrading other people's environment"; and avoid displacing "other species by taking over their habitats." This noteworthy study should kindle debates within the business community."

Sustainable advancement and development in relation to a nation is the process of making living, that area of land and/or water more useful or profitable for mankind. The life sickness affects over 30 % of global socio-economic and sustainable development turnover by way of healthcare, food and energy, agriculture and forestry. This percentage impact will grow with biotechnological developments which are increasingly improving the efficiencies of production processes in all spheres of life. This therefore implies that biotechnology occupy a very strategic position in the socioeconomic advancement and sustainable development of the nation in particular and the world at large. Scientific advances through the years have relied on the development of new tools to improve socio-economy such as health care, agricultural production, and environmental protection (Okonko et al., 2006).

As applied to the food industry it may be said that..."*sustainable food system*" is one that provides healthy food to meet current food needs while maintaining healthy eco-systems that can also provide food for generations to come with minimal negative impact to the environment (Clark, 2010). Sustainable development is also a key phrase used by politicians, economists and environmentalists.

Food Industry

European food sector is the largest manufacturing sector in Europe which transforms 70 % of EU's agricultural raw materials and employs over 4 million people. Development of Europe's food sector will have major impact on job creation, well-being and welfare in Europe. Croatia is a part of that sector. Consumer demand for different food products has changed in important ways over the last thirty years. For example, in both developed and developing countries, increasing per capita incomes, demographic shifts, urbanisation, smaller family units, and other life style changes have increased the demand for processed and imported food and individual portions and packaging. Throughout the world these changes have had a profound impact on the production and consumption of food. Also, there have been significant structural changes in the

food production systems and processing industry. These changes have reflected a number of issues including mentioned consumer demands, concentration and competition in the international food market, farm policy and programmes, technological developments, and public and private attitudes towards, for example, food safety, nutritional labelling and environmental concerns (Consumers internat., 2007). As a result of these rapid changes and their effects, consumers and governments are becoming increasingly concerned about the way in which agri-food sector is organised. The recent BSE outbreaks in Europe and developments in the application of genetically modified organisms, increasing environmental concerns and the growing power of multinational companies have resulted in an emerging global debate about agricultural practices and food production. Consumer concerns about food safety and quality, animal welfare and the environment are leading some governments to outline new visions for future agri-food policies in recognition of the need for reforms, but there is still a long way to go. Industrial food production focuses on economic efficiency, reliability and consistency, and market demand. Current systems of manufacturing, preservation, storage, processing, packaging, transportation and distribution, and retail are not necessarily sustainable. There is careless use of natural resources and waste of food raw materials. Policy or markets may favour unsustainable patterns of production and there is an inequitable remuneration of actors in the system. Much remains to be done to optimise the efficient use of non-renewable energy resources, recycled raw materials and to ensure that the use of packaging contributes less to problems of recycling.

It is clear, from many studies, that many food chains are lacking in sustainability, in its three dimensions; environment, social and economical sustainability.

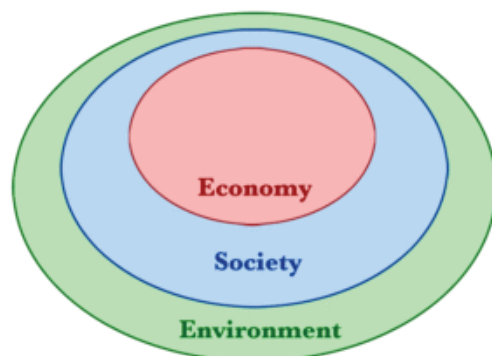

Fig. 1. A representation of sustainability showing how both economy and society are constrained by environmental limits (Ott, 2003)

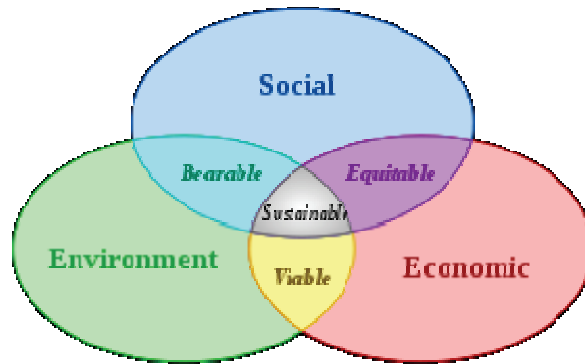

Fig. 2. Scheme of sustainable development: at the confluence of three constituent parts (Adams, 2006; UCN, 2006)

Environmental concern, social responsibility and economic viability are commonly identified as the three pillars of sustainability. With global inequalities becoming more pronounced, food costs climbing and global warming becoming a major political issue, food producers are simultaneously cast as perpetrator and potential healer. Meeting the needs of the present without comprising the future has to be taken into account by the food industry without undermining bottom line balance sheets, and the right balance between environmental, economic and social factors is needed (Coomber, 2008).

The Food Supply Chain

The food supply chain now accounts for 20 % of total global energy expenditure. It is highly dependent on fossil fuels and on average three times more energy is put into food than is actually produced. It also accounts for a quarter of all highway transport in the EU and has a water use average of 3.500 L/day per capita, while 1.5 billion people in the world still do not have access to safe drinking water. The Food Supply Chain (Fig. 3) is changing constantly, as technological innovations in farm production, food processing, storage and delivery systems evolve, and processors and retailers respond to consumer demands and expectations, and to economic, social and cultural circumstances (Downey, 2006). Although there are now global food chains there is no global body to consolidate the testing of all products. At the moment we have no harmonisation of labelling across countries and we have no validation process. Manufacturers now have the unenviable task of meeting the social demands with greater environmental and economic challenges. As investors

increasingly look to the methods behind manufacturing, assisted by new measuring techniques, developing the practices and technologies to create a sustainable and traceable food supply chain is becoming essential.

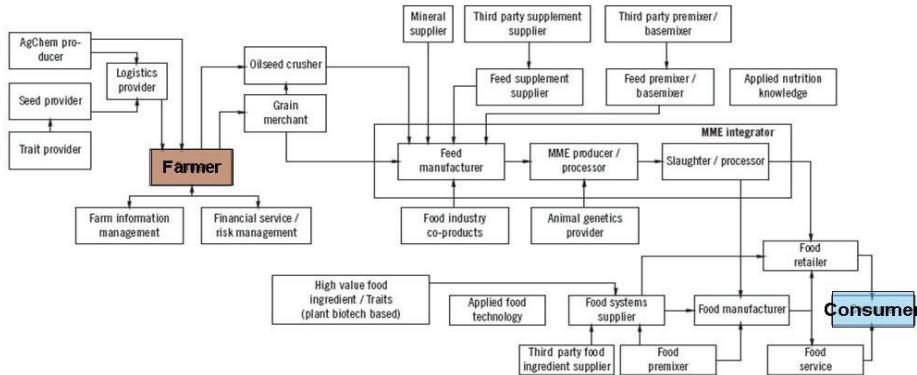

Fig. 3. Food (Chain) Network (Sciehefer, 2008)

For some, sustainability is still a luxury, but for others it is the difference between choosing a product or passing it over. The sooner manufacturers catch on to this and communicate habits with customers the more likely they are to win over the new breed of ethical consumer.

In the food industry, finding the right technology is just half of the battle. Although there are the technologies, they are not always taken up by the industry, there is a lot of confusion about sustainability because it means different things to different people. We can spend a lot of time developing new technologies that will help the symptoms but won't tackle the actual problem (Coomber, 2008).

Some of the main threats to general food production

The very notion of a sustainability transition, with its concern for humankind and the planet, reflects a process of globalization or interconnectedness, emerging forms of governance, and changing institutions and values. Most of these trends will work toward a sustainability transition, but not everywhere. Favorable shifts in investment, income, and job opportunities in some parts of the interconnected world are accompanied by the loss of jobs elsewhere, unpredictable withdrawals of capital, and a deepening divide in needed skills and innovation, all adding new sources of instability for the world's poor (Kates and Parris, 2003).

The biggest concern for general food production is a threat to agricultural land due to large-lot residential development, especially in developed and developing countries. The land area developed into ex-urban homes and rural land grew several times faster than the population growth rate. Urbanization is transforming domestic markets of developing countries into the main source of the global agri-food system. The finest farmer land and crop lands are disappearing faster than ever before. Europe will continue to lose considerable amounts of agricultural land in the coming decades, which is already happening in well developed regions. Besides, larger farmers no longer can find adequately skilled personnel for their production. In addition to the economic importance, the activities of the food industry are directly related to food security, which is still a major challenge in terms of human development pointing out to a dual responsibility of the industry. Social factors also influence trends in rural areas. One example is that the profits of a sale of arable land is often more than property owners can earn from their agri-production in that same year. Also, many children of farmers are choosing careers outside of agriculture, leaving no one to operate family farms (the number of people needed to produce food and maintain the land has decreased drastically) (Piližota, 2009 - UNIDO Analysis based on different sources, 2007/2008).

Sustainable agriculture

There is prediction that by 2050 the global population will grow to 9.2 billion people, and demand for agricultural products is expected to double. In the intervening years, the agri-food system will face increasing constraints and volatility driven by resource scarcity and climate change, raising the risk of production shortfalls.

“Global food production is a classic case of a system without coordination. No one intends their decisions to result in a system that is unsustainable. No one wants polluted estuaries or impoverished rural regions. Individuals make the best decisions possible, but they are doing so in a system that is critically fragmented. The pattern of falling commodity prices and production consistently driven beyond environmentally sustainable levels is repeated again and again, from corn, to coffee, to forest products, to fish” (Sustainable Food Lab website).

Sustainable farming requires a global commitment. If developed countries are serious about pursuing sustainable farming at home, they must also ensure that their trading partners can do the same, regardless of their ability to support it through public finances. It is thus essential to look into the scope for transferring resources from developed to developing countries for this purpose (Consumers international, 8 October 2007).

Many scientists, farmers, and businesses have debated how to make agriculture sustainable. Sustainable agriculture uses ecological principles to farm, hence the prefix agri- to farm and ecology- the science of the relationship between

organisms and their environment. It has been defined as "an integrated system of plant and animal production practices having a site-specific application that will satisfy human food and fiber needs, make the most efficient use of nonrenewable resources and on-farm resources and integrate, where appropriate, natural biological cycles and controls, sustainable, sustain the economic viability of farm operations, enhance the quality of life for farmers and society as a whole, over the long term (Wikipedia).

Sustainable agriculture should: a) optimize the use of resources to improve farm productivity and eliminate the use of unnecessary resources; b) support increased farm productivity, improving crop yields and nutritional quality to meet existing and future global business growth; c) preserve and maintain soil fertility, water and air quality and biodiversity within the agricultural activities; d) enable local farming communities to protect and improve their well-being and environments; e) integrate approved and credible science and technology, where applicable; and f) comply with governmental laws, regulations and industry standards (PepsiCo, 2009).

Environment

In developing new systems of crop production and livestock, central importance has to be the environmental component, including the implications of emerging climate change.

The daunting challenge involved in striking the optimum balance between the economic dictates of competitive farm production systems and the protection of Europe's rich heritage of natural and cultural resources, allied to the sustainability of rural regions, points to the concept of envisaging the environment as a *virtual economic entity*, within which a dynamic range of competing developmental, environmental, and social pressures have to be systematically accommodated, without the demands of one sector impacting unduly on others.

Waste utilization

Waste in the food chain is another major obstacle for increased sustainability. Over 200 million tonnes of food waste is produced in Europe each year. Recent European studies show that about 20 % of perfectly edible foods are lost as waste and the figures are much higher if non-edible waste is included. On a global dimension, waste is probably the major sustainability problem, as an important consideration for sustainability is the economical efficiency of the food chain. The socio-economic dimension of sustainability implies fairness in the transaction in the food chain and justice in the availability of affordable foods. It is feared by many that the present global economic crisis will aggravate the situation for the poorest in the world considerably, counteracting the improvements which have been made in the first part of the Millennium.

Agricultural research has pointed out a number of possibilities for more resource efficient primary production, but there is still globally a lack of political will to strongly promote more sustainable production methods.

The trend in the world today is to convert waste into useful products through the manipulation of microorganisms and to recycle waste product as much as possible and the role of microorganisms in waste utilization has been studied extensively by several authors. Some workers have thus explored ways of minimizing the environmental hazard posed by the gari industry effluent, not just by getting rid of it but by converting it to useful products. Waste utilization is another approach in waste management practice. Waste utilization is an ecologically safe and economically efficient method of waste management since; the waste is not treated spending money or disposed off in the landfill causing pollution. Therefore to manage food wastes, the general pathways of industrial-food waste generation should be reduced, recycled or reused and what is left must be treated and disposed of in an environmentally acceptable way. If a process is not environmentally friendly, it should be redesigned such that it becomes so and where a process cannot be redesigned, then it is necessary to reconsider whether it should be undertaken at all (Okonko et al., 2009).

Energy issues and Emerging Technologies

Energy issues are clearly of major import for Europe's agri-food industries and rural economies. Energy efficiency is of central importance in designing new farm production systems. Bio-energy generation could potentially make an important contribution to off-setting income losses in agriculture. However, early attention needs to be given to minimising the environmental impacts of intensive, mono-cultural energy-crops production.

Emerging technology is a general term used to denote significant technological developments that broach new territory in some significant way in their field. Emerging technologies are those technical innovations which represent progressive developments within a field for competitive advantage.

It's been a while that 'Pinch Technology' has been extensively employed all over the world to improve energy efficiency of various processes, as well as in food processing. One of the major application of Pinch Technology is for configuration of Energy Efficient Combined Heat and Power (CHP) cogeneration systems. Optimization of CHP systems is the area which offers maximum scope for energy cost savings in any industry, so that the overall energy consumption of the process is minimized.

Pinch Technology was introduced by Linnhoff and Vredevelde in 1979. It represents a set of thermodynamically based methods that guarantee minimum energy levels in design of heat exchanger networks, and use 'Pinch Analysis' to represent the application of the tools and algorithms of Pinch Technology for studying industrial processes. Food processing plants utilizing the information

obtained during the Pinch Analysis of the process can design energy efficient processing. This can help in creation of sustainable food supply chain.

Food for Life

Developing appropriate technologies and highlighting their safety is of paramount importance. A number of efforts are being made to build platforms which track the whole of the food supply chain. One of the most prevalent is the European Technology Platform Food for Life which aims to bring together key stakeholders to create a delivery strategy from farm to fork.

The ETP Food for Life published its Vision Document in June 2005 and its Strategic Research Agenda (SRA) in September 2007. Extensive consultations were held with all relevant stakeholders across Europe both in face-to-face meetings and through web-based consultations (ETP, 2005).

The European Technology Platform on Food for Life seeks to deliver innovative, novel and improved food products for, and to, national, regional and global markets in line with consumer needs and expectations through an effective integration of strategically-focussed, trans-national, concerted research in the nutritional-, food- and consumer sciences and food chain management. These products, together with recommended changes in dietary regimes and lifestyles, will have a positive impact on public health and overall quality of life ("adding life to years"). Such targeted activities will support a successful and competitive pan- European agro-food industry having global business leadership securely based on economic growth, technology transfer, sustainable food production and consumer confidence.

Conclusions

There are many challenges that need to be overcome to address the problems and develop and promote sustainable food production. Firstly, there is no generally agreed definition of sustainable food production - especially from a consumer perspective.

What is urgently needed is to define what sustainable food production means, and from that evolve a contemporary and coherent policy which can be used in all the regions in its own right but also when working with more specific topics. Also mapping perceptions of 'sustainable food production', linking this to cultural differences, and consumption patterns will be a priority in the future. Sustainability should bring together experts from all points in the supply chain to explore the opportunities afforded by sustainable produce industry practices. It is a way to add value, improve efficiencies and invest in the long-term for future generations. Sustainability does have a global dimension but the efforts for improvements must be made on the local scale, by each country, company and individual.

References

- Adams, W.M. (2006): The Future of Sustainability: Re-thinking Environment and Development in the Twenty-first Century. Report of the IUCN Renowned Thinkers Meeting, 29-31 January 2006. Retrieved on 16.02.2009.
- Baldvin, C.J. (2009): Sustainability in the Food Industry, IFT Press.
- Brundtland, G.H. (1987): Our Common Future (1987), Oxford: Oxford University Press.
- Clark, P. (2010): Moving Toward More Sustainable Food Processing, *Food Technology*, 2, 71-73.
- Consumers international, 8 October 2007.
- Coomber, N. (2008): Sustainable Food Production From Farm to Fork, foodprocessing-technology.com, 14 Nov 2008.
- Downey, L. (2006): EU Agri-Food Industries and Rural Economies by 2025 – Towards a Knowledge Bio-Economy Research and Knowledge-Transfer Systems, EU Commission, Brussels, November 2006.
- European Technology Platform on Food for Life (ETP) (2005).
- Hawken, P. (1993): The Ecology and Commerce: A Declaration of Sustainability, Harper Collins Publishers, New York.
- Kates, R.W., and Parris, T.M. (2003): Science and Technology for Sustainable Development Special Feature Long-term trends and a sustainability transition, The National Academy of Sciences, Proc Natl Acad Sci U S A. 2003 July 8; 100(14): 8062–8067. Published online 2003 June 26. doi: 10.1073/pnas.1231331100.
- Nachay, K. (2008): In search of sustainability, *Food Technology* 7, 38-49.
- Okonko, I.O., Adeola, O.T., Fajobi Enobong Aloysius, F.E., Oluseyi, A. (2009): Utilization of Food Wastes for Sustainable Development, *Electronic Journal of Environmental, Agricultural and Food Chemistry* 8 (4), 263-286.
- Ott, K. (2003): The Case for Strong Sustainability. In: Greifswald's Environmental Ethics, Ott, K. and Thapa, P. (ed.), Greifswald: Steinbecker Verlag Ulrich Rose. Retrieved on: 16.02.2009.
- PepsiCo- 1 – Jan 2009 - 2 – Jan 2009
- Piližota, V. (2008): Serving consumer demands Consumer needs for affordable food of good quality and diversity // *Delegate Manual, First European Food Congress: Food Production - Nutrition - Healthy Consumers* / Raspor, Peter (ur.). Ljubljana: Elsevier, 2008. (plenarno predavanje, mednarodna recenzija, sažetak, znanstveni).
- Schiefer, G. (2008): Food Chain Management ChallengeWorkgroup FCM, EU TP 2008. Sustainable Food Lab website
- Wikipedia, 2010
- Zollitsch, W., Winkler, C., Waiblinger, S., Haslberger, A. (2007): Sustainable food production and etics, Wageningen Academic Publishers.

Komercijalizacija znanstvenih istraživanja u funkciji gospodarske konkurentnosti Hrvatske

UDC: 339.137.2 : 167.7

D. Kovačević*

*Sveučilište Josipa Jurja Strossmayera u Osijeku, Prehrambeno-tehnološki fakultet
Osijek, Franje Kuhača 20, 31000 Osijek, Hrvatska*

Sažetak

Kao posljedica III. znanstveno-tehnološke revolucije uvjetovane razvitkom informacijsko-komunikacijske tehnologije, biotehnologije, automatizacije, kibernetizacije..., klasična ekonomija koja se temeljila na radu, zemlji i kapitalu postala je ekonomija znanja (engl.: knowledge economy) u kojoj ključnu ulogu ima intelektualni kapital, odnosno stvaralačka primjena znanja u proizvodnji. Komercijalizacija, odnosno pretvaranje znanja u novu ekonomsku vrijednost postala je mjera gospodarske konkurentnosti. U najrazvijenijim zemljama svijeta više od polovice BDP-a zasniva se na intelektualnom kapitalu, dok u najjačim svjetskim brandovima (Coca-Cola[®], GE, IBM[®], Microsoft[®], McDonald's[®]...) intelektualni kapital čini više od 75 % ukupne tržišne vrijednosti. EU se krajem 1990-tih godina suočila s tzv. „europskim paradoksom“ odnosno spoznajom da visoka znanost ne proizvodi automatski nove tehnologije i gospodarski rast, zbog čega EU zaostaje za napr. SAD i Japanom, dakle zemljama koje 2 – 3 puta više iz BDP-a izdvajaju za znanost te u odnosu na EU (64,32 %) imaju značajno veći udio industrije u ukupnom R&D-u (72,4 %, odnosno 78,53 %). Zaokret u politici EU koji je usmjeren na jačanje interakcije industrije i znanosti, komercijalizaciju znanja, veće ulaganje u znanost te postizanje cilja da EU postane „najkonkurentnije i najdinamičnije gospodarstvo znanja“, put je kojem treba težiti i Hrvatska. Aktualna gospodarska kriza i strukturalna kriza u Hrvatskoj, uz mjere gospodarske politike, zahtijevaju i promjene obrazovnog i znanstvenog sustava koji nije u potrebnoj mjeri u funkciji gospodarske konkurentnosti (napr. obrazovna struktura radne snage nije kompatibilna potrebama tržišta, razmjerno nizak udio studenata prirodnih i tehničkih znanosti itd.). Također, izvozni sektor, posebice prerađivačka industrija koja ima najveći udio u izvozu (91,4 %), treba postati osnovni potrošač inovacija i obrazovanja u koje ulaže država, što zahtjeva promjenu strukture znanstvenih programa i projekata. Bez potražnje izvoznog sektora za proizvodima "društva znanja" čitav projekt svest će se na stvaranje skupe i obrazovane radne snage za koju nema dugoročno održivih radnih mjesta u RH.

Ključne riječi: intelektualni kapital, inovacije, prerađivačka industrija, konkurentnost

* Dragan.Kovacevic@ptfos.hr

Uvod

Republika Hrvatska se nalazi na razvojnoj prekretnici. Nakon dva desetljeća obilježena ratnim stradanjima, tranzicijom i strukturnim poremećajima u gospodarstvu, Hrvatska se ulaskom u NATO i završavanjem pristupnih pregovora s EU te pod snažnim udarom globalne financijske krize, ponovno našla u situaciji preispitivanja gospodarskih politika i traženja novih razvojnih modela. Najkonzistentniji dokument u Hrvatskoj koji bi jednim dijelom trebao osigurati oporavak zemlje i izlazak iz gospodarske krize, a drugim, osigurati temelje za dugoročni gospodarski rast i razvoj je vladin Program gospodarskog oporavka iz travnja 2010. godine. Oko programa je postignut nacionalni stručni i politički konsenzus, a dobio je i potporu relevantnih međunarodnih financijskih institucija, Svjetske banke i MMF-a. Alternativa povlačenja odlučnih poteza koji su prezentirani u vladinom Programu gospodarskog oporavka je ili novi *stand by* aranžman s MMF-om sa svim posljedicama na ekonomski rast i standard građana ili potpuni slom javnih financija koji bi se prije svega manifestirao nemogućnošću servisiranja proračunskih obveza. Dio Programa koji se odnosi na obrazovanje i znanost mogao bi se kratko sažeti u 3 točke: racionalizacija i štednja, prilagodba sustava obrazovanja tržištu rada te jačanje suradnje znanosti i gospodarstva. Sve mjere za promjene u obrazovnom i znanstvenom sustavu kao doprinos oporavku gospodarstva i gospodarskoj konkurentnosti su neophodne i na tragu su strateških smjernica EU definiranih u dokumentima Europskog vijeća i Europske komisije: “Green paper on innovation” (EC, 1995), “First Action Plan for Innovation” (EC, 1996), Lisbon European Council (2000) i „Barcelona European Council“ (2002). Činjenica je da smo unatoč službenom opredjeljenju za razvoj gospodarstva utemeljen na znanju, odnosno opredjeljenju za „društvo znanja“ u značajnom raskoraku sa zemljama kojima želimo gospodarski konkurirati i to prije svega zbog neobjektivne ocjene stvarnih slabosti znanstvenog i obrazovnog sustava. Naime, vladin Program u segmentu obrazovanja i znanosti može pasti na dvije razine, jedna je politička i ona je vezana uz efikasnost provedbe zacrtanih mjera prije svega od strane Vlade, a druga razina je obrazovna i znanstvena infrastruktura (nastavnici, znanstvenici, fakulteti, instituti itd.), dakle svi oni na koje se promjene izravno odnose i koji bi u realizaciji Programa trebali proaktivno sudjelovati. Politička razina obuhvaća primarno žurnost donošenja svih potrebnih zakona i ostalih dokumenata kako bi se program operacionalizirao te isto tako osiguranje potrebnih sredstava, jer bez novca nema reformi. Druga razina je obrazovna i znanstvena infrastruktura, nastavnici i znanstvenici, ali i svi oni koji rade u sustavu obrazovanja i znanosti. Na toj razini, a svjesni smo toga već sada, imat ćemo snažan otpor i zbog nužnosti racionalizacije poslovanja, smanjenja broja zaposlenih, novih kriterija napredovanja do činjenice da će znanstvenici u buduću svoje projekte morati sve više evaluirati u proizvodnji, odnosno u realnom sektoru. Pokazalo se da broj doktora znanosti, odnosno općenito znanstvenika nije proporcionalan

gospodarskom rastu, odnosno ne govori o stvarnom potencijalu zemlje i obrazovnog sustava. Dva su ključna problema, prvi, obrazovna struktura radne snage u Hrvatskoj nije kompatibilna zahtjevima tržišta, odnosno ponudi i potražnji rada u smislu znanja, stručnosti i sposobnosti te troškova rada. Drugo, Hrvatska je deficitarna intelektualnim kapitalom, odnosno znanje nije u dovoljnoj mjeri u funkciji rješavanja konkretnih problema u proizvodnji, odnosno u funkciji gospodarske konkurentnosti zemlje. Naime, kao posljedica III. znanstveno-tehnološke revolucije uvjetovane razvitkom informacijsko-komunikacijske tehnologije, biotehnologije, automatizacije, kibernetizacije..., klasična ekonomija koja se temeljila na radu, zemlji i kapitalu postala je ekonomija znanja (engl.: knowledge economy) u kojoj ključnu ulogu ima intelektualni kapital, odnosno stvaralačka primjena ili sposobnost primjene znanja u proizvodnji. U svojoj knjizi „Budućnost kapitalizma“ L.C. Thurow je napisao: «...U globaliziranom svijetu kada sve ispadne iz jednadžbe konkurentnosti, znanje i sposobnost organizacije ostaju jedina komparativna prednost jedne države i jedne nacionalne ekonomije. Oni koji u globaliziranom svijetu budu ekonomski vladali morat će biti spremni obrazovati, organizirati i mobilizirati intelektualnu snagu.» (Thurow, 1997). Sposobnost stvaranja, širenja i iskorištavanja znanja i informacija postaje pokretač gospodarskog rasta, ali i općenito standarda i kvalitete života stanovništva. Proizvodni proces sve se više pretvara u znanstveni proces koji rezultira nizom revolucionarnih otkrića - novih industrijskih materijala, proizvodnih tehnologija i dizajna koji su omogućili ponudu proizvoda i usluga koji su prije nekoliko godina bili potpuno nepoznati (Sundać i sur., 2009). Kao rezultat toga dolazi i do promjene kvalifikacijske strukture zaposlenih: fizički radnici zamjenjuju se tzv. umnim radnicima koji lakše prihvaćaju tuđu tehnologiju i brže razvijaju vlastitu te su spremni na stalna poboljšanja. Inovacija, komercijalizirano znanje, odnosno znanje pretvoreno u ekonomsku vrijednost kroz tehnologije koje su konkurentne na tržištu, postaje mjerilo gospodarske konkurentnosti. Zahtjevi koji se postavljaju pred Hrvatsku kao zemlju koja se deklarirala kao „društvo znanja“ treba promatrati u 3 smjera, pri čemu se prva dva: produciranje konkurentne radne snage i stavljanje inovacija u funkciju izvoznog sektora, odnose na znanstveni i obrazovni sustav, dok se treći odnosi na neophodnost žurne provedbe strukturnih reformi u gospodarstvu.

Komparativna prednost i gospodarska konkurentnost

Kategorija konkurentnosti potisnula je dugo prisutnu teoriju **komparativnih prednosti**. Naime, prirodna bogatstva (sirovine), prirodne ljepote i lokacija gospodarskih aktivnosti u cijelosti su zamjenjene sposobnošću tvrtki i cjelokupnoga gospodarstva da ponudi proizvod ili uslugu čija se dodatna vrijednost temelji na efikasnosti većoj od domaće ili inozemne konkurencije: kroz bolju kvalitetu i nižu cijenu. Napr. u proizvodnji namještaja nije više najvažnije gdje raste

najkvalitetnije drvo i gdje ga ima u najvećim količinama već gdje je najatraktivniji dizajn i distribucijska logistika (Vedriš, 2005). Klasična teorija komparativne prednosti (19. i 20. stoljeće) prema kojoj je lociranje gospodarskih aktivnosti na određenom području bilo rezultat bogatstva prirodnim resursima i obilja jeftine radne snage – nema više uporište (Thurow, 1997). Danas su znanje i umijeće primjene znanja u praksi (**intelektualni kapital**) ključna komparativna prednost i postali su glavna odrednica lokacije gospodarskih aktivnosti krajem 20. i početkom 21. stoljeća. Industrije temeljene na ljudskoj intelektualnoj snazi nisu geografski vezane - mogu se locirati bilo gdje u svijetu. Napr. Silicijska dolina i Cesta 128 su locirane tamo gdje jesu, jednostavno zato što je tu koncentracija intelektualne snage. U doba industrija koje se temelje na ljudskoj intelektualnoj snazi omjeri između kapitala i rada prestaju biti smislene varijable, jer se među njima ruši svaka razlika. Znanje, sposobnost primjene znanja, ljudski kapital i sl. stvaraju se istim investicijskim sredstvima kojima se stvara i fizički kapital. Također, treba uzeti u obzir i činjenicu da je raspoloživost prirodnih resursa jednim dijelom ispala iz jednadžbe konkurentnosti, jer moderni proizvodi jednostavno troše manje prirodnih resursa. Danas, mostovi i automobili imaju ugrađeno manje tona čelika, a uređaji kao što su računala gotovo da i ne troše prirodne resurse. Pali su troškovi prijevoza i komunikacije. Japan je zanimljiv primjer, ima najjaču čeličnu industriju u svijetu, a da pri tome nema niti ugljena, niti željezne rude. To se nije moglo dogoditi u 19., niti u većem dijelu 20. stoljeća. Zaključno, dok se u prošlosti razvitak zemlje zasnivao na komparativnim prednostima, poput jeftine radne snage i prirodnih resursa, danas se osnovom za ekonomski razvitak smatraju napredni faktorski uvjeti zasnovani na znanju i razvijenoj infrastrukturi, visokoj tehnologiji te **inovacijama**.

Prema definiciji OECD-a, **konkurentnost** je mjera sposobnosti zemlje da u slobodnim i ravnopravnim tržišnim uvjetima proizvede robe i usluge koje prolaze test međunarodnog tržišta, uz istovremeno zadržavanje i dugoročno povećanje realnog dohotka stanovništva, odnosno boljeg životnog standarda za sve (Družić, 2001). Države koje su gradile i ostvarivale strategiju izvozne orijentacije ostvarile su puno bolje makroekonomske rezultate, osobito BDP per capita, od zemalja koje primjenjuju strategiju unutarnje orijentacije. Hrvatska je sa tržištem od 4,5 mil potrošača nužno orijentirana prema stranim tržištima, no postavlja se temeljno pitanje gospodarske konkurentnosti. Problem konkurentnosti je u osnovi problem niske produktivnosti koja se može povećati sniženjem troškova poslovanja kao i uvođenjem novih proizvoda i tehnologija. Na žalost, u Hrvatskoj je razina produktivnosti uglavnom bila rezultat pasivnog restrukturiranja – smanjenja radnih mjesta koje je s druge strane produciralo nove umirovljenike i stvaralo dodatni pritisak na gospodarstvo, a znatno manje, produktivnost je bila rezultat povećanja efikasnosti, investicija, inovacija i novih tehnologija. Taj model je potrošen, njegova posljedica su podinvestiranost industrije i neodrživ odnos zaposlenih i umirovljenika koji je danas u RH 1:1,28 (srpanj, 2010. godine) s napomenom da s prosječne 52 godine imamo jednu od najmlađih umirovljeničkih populacija u

Europi te da 190.000 umirovljenika od ukupno 1.184.485, odnosno 15,4 % su korisnici povlaštenih mirovina (bivši saborski zastupnici, borci NOB-a, JNA, HD vojske, HVO-a, hrvatski branitelji, bivši članovi HAZ-u i dr., odnosno ukupno 13 skupina) na koje financijski otpada $\frac{1}{4}$ ukupnih mirovina. Zato se postavlja pitanje: je li domaća proizvodnja u mogućnosti povećavati produktivnost, a time i konkurentnost na novim osnovama, odnosno inovacijama te ulaganjem u znanost i nove tehnologije. Iako je činjenica da su inovacije temelj gospodarske konkurentnosti, među domaćim stručnjacima ne postoji konsenzus kako poboljšati inovativnost gospodarstva. Razlog tome je da inovativnost nije rezultat samo snažnog razvojno-istraživačkog sektora već i sposobnosti gospodarstva da apsorbira inozemne tehnologije te da izvrši difuziju novih tehnologija u tradicionalne sektore (Nacionalno vijeće za konkurentnost, 2008). Konkurentnost gospodarstva, odnosno snažni R&D, komercijalizacija znanja kroz inovacije te uvođenje novih tehnologija u izravnoj je vezi s ljudskim kapitalom i konkurentnošću radne snage (obrazovna struktura, kompatibilnost (podudarnost) ponude i potražnje rada u smislu znanja, stručnosti i sposobnosti te troškovi rada), odnosno obrazovnog sustava zemlje (Bejaković, 2004 i 2005). Dokazano je da su stupanj obrazovanosti radne snage (mjeren godinama školovanja), kao i izdvajanja javnoga sektora za obrazovanje, visoko korelirani sa stopom rasta realnog dohotka po stanovniku. Također, utvrđeno je da stupanj obrazovanja djeluje na gospodarski rast ponajviše kroz tehnološke inovacije i brzinu prihvaćanja i širenja novih tehnologija. No, više je istraživanja pokazalo da je utjecaj istraživanja i razvoja te obrazovanja na niskoj razini razvijenosti slab, sve dok se ne dosegne određena razina razvijenosti. Dok u velikim zemljama veći rashodi za tu djelatnost te za istraživanje i razvoj mogu povećati stopu inovacija, u malim zemljama oni u prvom redu služe za olakšavanje transfera tehnologije iz inozemstva. Samo stručno znanje pri tome nije dovoljno: zaposleni danas moraju biti sposobni stvarati, analizirati i transformirati informacije, djelotvorno komunicirati te organizirati i koordinirati poslovne aktivnosti. Traže se razvijene komunikacijske sposobnosti, informatička znanja te sposobnosti i spremnost na daljnje učenje i usavršavanje. Može se s priličnom sigurnošću procijeniti da su obrazovni programi u tranzicijskim zemljama srednje i istočne Europe (pogotovo oni temeljeni na austro-njemačkom modelu) više usmjereni na memoriranje zadanog gradiva nego na samostalno analitičko i kritičko razmatranje i zaključivanje, te na inovativni pristup, što je sigurno otežavajući čimbenik u drugačijem pristupu obrazovanju i budućem radu. Danas se težište stavlja na analitičke sposobnosti – mogućnosti traženja i odabiranja informacija, razjašnjavanje problema, formuliranja pretpostavki, potvrđivanje i procjenu dokaza i iznalaženje rješenja. Proces globalizacije je naglasio važnost znanja i navedenih obilježja zaposlenih, koje postaju presudne odrednice ostvarivanja konkurentne sposobnosti u gospodarskoj i tržišnoj utakmici. Treba također imati u vidu da je pojam ljudskog kapitala širi od samog formalnog obrazovanja stanovništva i zaposlenih, jer bi trebao uključivati i sva znanja i vještine stečene neformalnim putem, pa čak, u

najširoj definiciji i investicije u zdravlje. Stoga, razina ljudskog kapitala ne mora biti jednaka prosječnoj razini formalnog obrazovanja. Prema više izvora OECD-a i Svjetske banke, u mnogim zemljama Južne Amerike velik je broj i visok udio pravnika, profesora književnosti i filozofije u ukupnom broju upisanih i diplomiranih studenata, dok je u skandinavskim zemljama mnogo osoba koje studiraju elektrotehniku, informatiku, management i sl. (Bejaković, 2004). Iako su obje skupine visokoobrazovanih društveno važne, za gospodarski razvoj ipak je ključna druga skupina. Naime, struktura upisanih i završenih učenika i studenata trebala bi što je moguće više odgovarati postojećoj te posebice budućoj željenoj strukturi nacionalnoga gospodarstva. Pojednostavljeno, ako pojedina zemlja ima napr. razvijenu proizvodnju telekomunikacijskih uređaja poput Finske s Nokiom, onda je poželjan upis i diplomiranje što većeg broja inženjera elektrotehnike i sličnih zanimanja. Ako je pak gospodarstvo neke zemlje većinom utemeljeno na razvoju turizma ili pružanju usluga, odnosno na očuvanju povijesno-kulturnog blaga, kao napr. u Grčkoj, tada težište treba biti na upisivanju i diplomiranju managera u turizmu, povjesničara umjetnosti, restauratora i sl.

Kako bi se sustavno pratila i procjenjivala konkurentnost gospodarstva, odnosno STI (znanje, inovacije i tehnologije) u EU i zemljama OECD-a koriste se sljedeći pokazatelji: istraživanje i razvoj (D&B) i investiranje u znanje, inovacijska politika, statistika znanosti i istraživanja, patentiranje sveučilišta i javnih istraživačkih centara, interakcija između znanosti i tehnologije (inovacije) i patentiranje po regijama i industrijama te S&T aktivnosti u biotehnologiji, nanotehnologiji i zaštiti okoliša.

Intelektualni kapital, inovacija i inovacijska politika - definicija i upotreba pojmova

Za razliku od tradicionalnih teorija poduzeća u kojima su dominantni resursi bili fizički kapital (zemlja, tvornice i oprema), fizički rad (manualnih radnika) i financijski kapital (novac), poslovanje suvremenih poduzeća većinom se zasniva na neopipljivoj imovini. Dodana vrijednost koju subjekti u poslovnom procesu danas stvaraju proizlazi prije svega iz znanja, sposobnosti i vještina ljudi koji su zaposleni u poduzeću ili sa njim surađuju kao poslovni partneri ili vanjski suradnici. Kapitalna imovina danas potrebna za kreiranje bogatstva nije više zemlja, ni fizički rad, nisu to ni strojevi, alati ili tvornice – umjesto njih to je intelektualna imovina, odnosno intelektualni kapital. Sposobni zaposlenici koji razvijaju nove ideje, stvaraju vrijednost i inoviraju poslovanje poduzeća postali su ključna imovina nove ekonomije (Kolaković, 2003).

Pojam **intelektualni kapital** u ekonomskom je smislu po prvi put upotrijebljen 1958. godine u financijskim analizama tržišne vrijednosti tada malih znanjem-intenzivnih poduzeća kao što je bio Hawlett-Packard čija se imovina sastojala uglavnom od intelektualnog kapitala, a njihova je visoka vrijednost na burzi nazivana intelektualnom premijom. U današnjem ga značenju po prvi put

primjenjuje John Kenneth Galbraith godine 1969. u svojem pismu ekonomistu Michaelu Kaleckom, dok šira upotreba i popularnost termina intelektualni kapital započinje tek nakon članka Thomasa A. Stewarta: “Brainpower - How Intellectual Capital is Becoming America’s Most Valuable Asset” objavljenog u časopisu Fortune 1991. godine te se ta godina smatra “rođenjem” koncepcije intelektualnog kapitala (Kolaković, 2003). Stewart kao “pionir intelektualnog kapitala u tome povijesnom članku, definira intelektualni kapital kao: “sumu svega što svi u kompaniji znaju, a što joj daje konkurentsku prednost na tržištu. To je intelektualni materijal - znanje, informacije, intelektualna imovina, iskustvo - koje može biti iskorišteno za stvaranje bogatstva”. U svojoj prvoj knjizi, bestselleru “Intellectual Capital: The New Wealth of Organizations” iz godine 1997. Stewart je redefinirao standarde i prioritete suvremenog poslovanja, dokazujući da najvažnija imovina koju poduzeća posjeduju danas nisu materijalna dobra, oprema, financijski kapital ili tržišni udio, već su to nedodirljivi resursi: patentni, znanje radnika, informacije o kupcima i prošla iskustva koja poduzeća imaju u svojoj institucionalnoj memoriji. U knjizi „The Wealth of Knowledge: Intellectual Capital and the Twenty-first Century Organization¹⁶” iz 2001. godine Stewart prikazuje kako današnja poduzeća primjenjujući Teoriju intelektualnog kapitala u svakodnevnim operacijama, drastično povećavaju poslovni uspjeh u tržištu. Na osnovi Stewartovih postavki i brojni su drugi autori iznijeli **definicije intelektualnog kapitala** u kojima jasno naglašavaju razliku između znanja i intelektualnog kapitala (Kolaković, 2003). Intelektualni kapital predstavlja znanje kao dinamičan ljudski proces, ali tek kada su znanje i inteligencija primijenjeni i transformirani u nešto vrijedno za poduzeće i potrošače njegovih proizvoda - znanje postaje vrijedna imovina, tj. intelektualni kapital poduzeća. Pod **eksplicitnim znanjem** podrazumijeva se ono znanje koje može biti kodificirano, zaštićeno patentom ili trgovinskom tajnom i koje ima oblik komercijaliziranih proizvoda ili je utjelovljeno u strojevima i procedurama kojima se poduzeća koriste u svojim proizvodnim sustavima. U poduzeću eksplicitno znanje predstavljaju transparentni oblici, npr.; nacrti, tehničke specifikacije ili standardizirane kreacije (dizajni). **Implicitno ili (tiho) znanje** oblikuje se iz industrijskog know-how-a i ono je nevidljiva imovina poduzeća. Nije jasno artikulirano, a nalazi se u međudodnosima zaposlenih na njihovom radnom mjestu i unutar njihove radne grupe. Ono se isto tako nalazi i u rutinama i kulturi koju je poduzeće razvilo, koji daju rješenja različitih problema koji se u tijeku poslovanja pojavljuju.

Inovacije nisu samo revolucionarna otkrića koja su korjenito promijenila svijet (parni stroj, izmjenična struja ili nuklearna energija), inovacije nastaju svakodnevno u proizvodnim i uslužnim djelatnostima kao pokušaj tehničko-tehnološkog poboljšanja i prilagodbe pojedinih radnih operacija, a što u završnici rezultira povećanjem asortimana proizvoda i razvitkom tvrtke kroz povećanu konkurentnost (napr.: nakon istraživanja tržišta i značajnog pada prihoda u 2001. godini McDonald’s pravi veliki zaokret prema „zdravoj prehrani“ i uvodi nove

artikle kao što su različite salate; napr. Nestle u proizvodnji Nescafe 1965. i 1967. godine uvodi granule i sušenje liofilizacijom što daje bolju topljivost kave i bolje očuvanje arome; napr. marketinška strategija IKEA-e u proizvodnji i distribuciji namještaja; napr. pakiranje pića u limenkama i ambalaži različitih volumena; napr. redizajn prtljažnika toyotinih automobila nakon proučavanja ponašanja potrošača na parkiralištima (Kotler, 2001). Svaka žena prilikom kuhanja zasigurno je u životu nesvjesno napravila brojne inovacije. Ključno je samo pitanje treba li izum nekome i može li se kao takav komercijalizirati i donijeti poduzetnički profit. Da bi bila komercijalno uspješna inovacija mora predstavljati novu vrijednost za kupca. U tom smislu samo tehnička inovacija koju Eurostat definira kao razvoj proizvoda i procesa i ograničeni udio organizacijskih inovacijskih aktivnosti kao što su marketing i trening u funkciji implementacije novih proizvoda, usluga i procesa - nije dovoljna te je ona često praćena novim poslovnim modelom. Ono što je pri tome bitno jest stvaranje novog tržišta bilo putem tehničke inovacije, poslovnog modela ili njihove kombinacije.

Inovator je osoba koja kroz znanje i najčešće iskustvo u određenom području prepoznaje potrebe tržišta i razvija ideju za novi proizvod ili uslugu. Cilj svakog inovatora ili izumitelja u komercijalnom ili poduzetničkom smislu je patentirati određeni proizvod, kako bi ostvario tržišni monopol. Inovacijska poduzeća su poduzeća koja su uvela nove ili poboljšane proizvode ili usluge na tržištu ili nove ili poboljšane procese.

Patent je pravo priznato za izum koji nudi novo rješenje nekog tehničkog problema, a obično se odnosi na određeni proizvod, postupak ili primjenu. Patent osigurava vlasniku isključivo pravo na izradu, korištenje, stavljanje u promet ili prodaju izuma zaštićenog patentom, tijekom određenog vremena. Patent predstavlja privatno vlasništvo čiju uporabu vlasnik može dopustiti drugim osobama na određeno vrijeme davanjem licencije ("iznajmiti") ili ga u potpunosti prenijeti ("prodati"). Patent se stječe priznanjem prava od strane ovlaštenog državnog tijela za dodjelu tog prava (u Republici Hrvatskoj Državni zavod za intelektualno vlasništvo - DZIV).

Inovacijska politika je središnja politika gospodarstva znanja, jer joj je cilj staviti znanje u funkciju gospodarskog rasta kroz inovaciju kao pokretača gospodarskog rasta. Integrativni karakter inovacijske politike proizlazi iz integrativnog karaktera inovacije kao vrlo kompleksne pojave koja integrira u sebi znanstvena istraživanja, tehnološku primjenu i komercijalnu eksploataciju. Produktivnost se ne mora automatski poboljšati ako zemlja ulaže u R&D i inovacije. Tehnologija i tehnološka promjena se ne pretaču automatski u produktivnost, a time ni u konkurentnost. Na primjer, difuzija IT ne podiže automatski produktivnost ako njena upotreba nije usmjerena na ključne nosioce poslovnog procesa, odnosno na one aspekte poslovnog procesa koji stvaraju vrijednost kupcu. Produktivnost može biti također i rezultat smanjenja zaposlenosti i ne mora biti nužno vezana za uvođenje novih tehnologija. Inovacija je više od R&D i obuhvaća široki niz aktivnosti u poduzeću u čijoj osnovi je inženjerski dizajn proizvoda ili procesa.

Znanstvena istraživanja igraju važnu ulogu, ali ona nisu osnovni izvor ekonomski i komercijalno relevantnih inovacija u svakodnevnom inovacijskom procesu. Daljnja poboljšanja inovacija mogu biti ekonomski važnija od originalnog izuma. S druge strane, inovativnost zemlje je određena kvalitetom interakcije između R&D, potražnje za inovacijama, apsorpcijskim kapacitetom i difuzijom znanja i inovacija putem tržišta i putem ne-tržišne suradnje. **Apsorpcijski kapacitet** je u osnovi sposobnost radne snage da brzo usvaja novu tehnologiju i adaptira je kako bi se poboljšala produktivnost poduzeća. Ova sposobnost ovisi o stupnju obrazovanosti radne snage, te o stupnju u kojem se radna snaga redovno stručno usavršava. **Potražnja za tehnologijom i inovacijama** je ključna odrednica inovativnosti, jer nedostatak potražnje znači da ne postoje ekonomski poticaji da se novo znanje primjenjuje u poslovnom procesu. Ukoliko poduzeće može povećati produktivnost smanjenjem zaposlenosti, izbjegavanjem konkurencije, odnosno traženjem zaštite domaćih proizvođača ono će u pravilu pribjeći ovim lakšim metodama održanja konkurentnosti i produktivnosti. S druge strane, pretjerana konkurencija može također destimulirati poduzeće na bilo kakvo inoviranje, posebice ako je tehnološki jaz u odnosu na konkurenciju prevelik. **Difuzija inovacija** je ključna za širenje produktivnosti. Slabe veze između malih i velikih poduzeća u ‘lancu vrijednosti’ usporavaju širenje novih tehnologija i poslovnih procesa čime se smanjuje inovativnost ukupne ekonomije. Konačno, **ulaganja u (R&D)** su važna ne samo da bi se uveli novi proizvodi i procesi već i da bi se uspješno adaptirali uvezeni proizvodi i tehnologije. Samo zemlje i poduzeća koje ulažu u vlastiti R&D mogu pratiti tehnološki razvoj i adaptirati ih u svom poslovnom procesu. Inovativnost jedne zemlje rezultat je interakcije između pojedinih komponenti koje su sve potrebne da bi zemlja imala razvijen inovacijski kapacitet. Zemlja koja povećava inovacijski kapacitet treba stvoriti povoljan okoliš kako bi došlo do interakcije pojedinih komponenti: makroekonomski okoliš povoljan za rast i stabilnost, snažnu konkurenciju, razvijene veze znanost – industrija, pristup rizičnom kapitalu, infrastrukturna podrška, itd. Inovacijska funkcija obrazovanja je poboljšanje apsorpcijske sposobnosti za inovacije, a ne samo obrazovanje za postojeće tehnologije.

Europski paradoks i inovacijska politika EU

Svjetsko se gospodarstvo danas nalazi u fazi dubokih strukturnih promjena na raskrižju između dosad dominantne masovne proizvodnje i novog proizvodnog modela zasnovanog na znanstveno-tehnološkim, informacijsko-komunikacijskim djelatnostima, infrastrukturi te uslugama. Kada je riječ o masovnoj proizvodnji, povratni učinak globalizacije daje konkurentsku prednost zemljama s jeftinijim faktorima proizvodnje (posebno rada) i otuda potječe uspon zemalja poput Kine i Indije na globalnoj ekonomskoj sceni. Europa se nalazi u fazi promjena i traženja novih gospodarskih prednosti na temelju traženja nove uloge države blagostanja i afirmacije uloge znanosti, tehnologije, informacijsko-

komunikacijske infrastrukture te usluga. Kao posljedica III. znanstveno-tehnološke revolucije uvjetovane razvitkom informacijsko-komunikacijske tehnologije, biotehnologije, automatizacije, kibernetizacije..., klasična ekonomija koja se temeljila na radu, zemlji i kapitalu postala je ekonomija znanja (engl.: knowledge economy) u kojoj ključnu ulogu ima intelektualni kapital, odnosno stvaralačka primjena znanja u proizvodnji. Komercijalizacija, odnosno pretvaranje znanja u novu ekonomsku vrijednost postala je mjera gospodarske konkurentnosti. U najrazvijenijim zemljama svijeta više od polovice BDP-a zasniva se na intelektualnom kapitalu (Tablica 1), dok u najjačim svjetskim brandovima (Coca-Cola®, GE, IBM®, Microsoft®, McDonald's®...) intelektualni kapital čini više od 75 % ukupne tržišne vrijednosti (Slika 1).

Tablica 1. Globalni raspored svjetskog bogatstva (Sundać i sur., 2004)

Table 1 World distribution of global wealth (Sundać et al., 2004)

R.b. (No.)	DRŽAVE (STATES)	Broj država (No. of states)	Udio u svjetskom kapitalu (Share in world capital)	Prirodni kapital (Natural capital)	Ljudski kapital (Human capital)	Proizvodni kapital (Production capital)
1.	Izvoznici sirovina (Exporters of raw materials)	63	4,6 %	44 %	36 %	20 %
2.	Manje razvijene zemlje (Less developed countries)	100	15,9 %	28 %	56 %	16 %
3.	Razvijene zemlje (Developed countries)	29	79,4 %	17 %	67 %	16 %

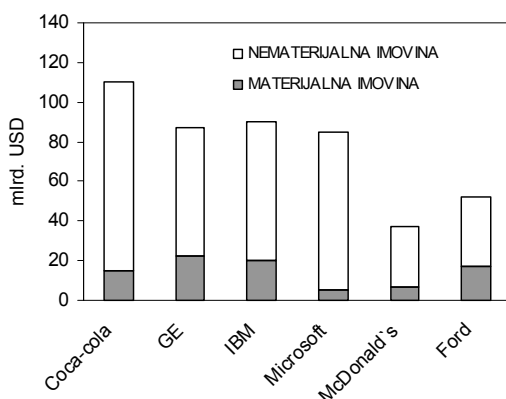

Slika 1. Udio materijalne i nematerijalne imovine u ukupnoj vrijednosti najjačih svjetskih brandova (Sundać i sur., 2009)

Fig. 1. Share of material and non-material assets in the total value of the world's top brands (Sundać et al., 2009)

EU se krajem 1990-tih godina suočila s tzv. „europskim paradoksom“ odnosno spoznajom da visoka znanost ne proizvodi automatski nove tehnologije i gospodarski rast, zbog čega EU zaostaje za napr. SAD i Japanom, dakle zemljama koje 2 – 3 puta više iz BDP-a izdvajaju za znanost te u odnosu na EU (64,32 %) imaju značajno veći udio industrije u ukupnom R&D-u (72,4 %, odnosno 78,53 %) (Slike 2 i 3).

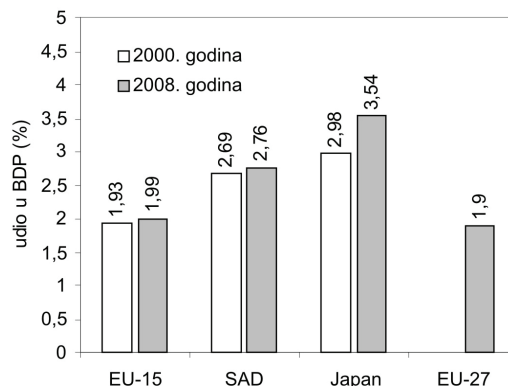

Slika 2. Udio proračunskih ulaganja pojedinih zemalja u R&D u 2000. i 2008. godini u BDP-u izražen u % (MZOŠ, 2010.; Eurostat, 2010)

Fig. 2. GDP share of R&D budgetary investments in individual countries in 2000 and 2008, expressed in % (MSES, 2010; Eurostat, 2010)

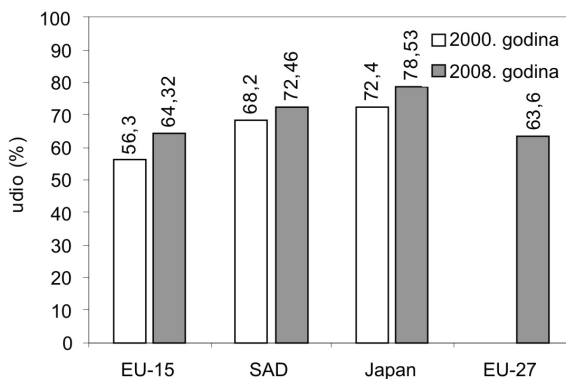

Slika 3. Udio industrije u financiranju R&D u pojedinim zemljama u 2000. i 2008. godini izražen u % (MZOŠ, 2010; Eurostat, 2010)

Fig. 3. Share of industry in R&D financing in individual countries in 2000 and 2008, expressed in % (MSES, 2010; Eurostat, 2010)

“**Green paper on innovation**” (EC, 1995) („Zeleni papir o inovaciji“) je identificirao „europski paradoks“ koji se sastoji u jakim istraživačkim, ali slabim inovacijskim i ekonomskim performansama. Definiranjem ovog problema koji je nazvan 'inovacijski deficit' ukazano je na širi pogled na inovaciju te na potrebu da politika podrži ukupan inovacijski proces, a ne samo R&D. Ovaj dokument naglašava: potrebu intenzivnije suradnje znanosti i gospodarstava (interakcija) te tržišnu eksploataciju istraživanja. Inovacijska politika polazi od načela da je R&D neophodan, ali nedovoljan uvjet razvoja tehnološke promjene, te linearni model inovacija na kojem se zasniva znanstvena politika i neoklasični model rasta, zamjenjuje interaktivnim modelom inovacija. Čak 19 zemalja OECD-a ima porezne olakšice za svoje R&D aktivnosti, dok 6 zemalja nudi i olakšice za obrazovanje zaposlenika. O gospodarstvu znanja možemo govoriti kada stopa ulaganja u znanje nadmašuje stope ulaganja u ostale vrste kapitala. U OECD zemljama investicije u znanje tijekom 1990-tih rastle su po godišnjoj stopi od 3,4 %, a bruto investicije u osnovna sredstva (fiksni kapital) po nižoj stopi od 2,2 % godišnje. Najbliže gospodarstvu znanja, jer najviše ulažu u znanje (između 5,2 i 6,5 % BDP-a), su Švedska, USA, Koreja i Finska.

Kao rezultat GPI Europska komisija je usvojila “**First Action Plan for Innovation**” (EC, 1996), (Prvi akcijski plan za inovaciju u Europi), koji je po prvi puta stvorio zajednički analitički i politički okvir za inovacijsku politiku u Europi unutar kojeg se inovacija poima kao rezultat kompleksne interakcije između pojedinaca, organizacija i faktora iz okruženja. Temeljem ovog plana, stvoren je 1999. godine „Trend Chat on Innovation in Europe“, praktični mehanizam za nosioce inovacijske politike i managere u Europi. Ovaj program organizira DG 'Innovation'. Program prikuplja, redovno ažurira i analizira informacije o inovacijskim politikama na nivou zemalja članica i EU s fokusom na financiranje inovacija, razvoj inovacijskog biznisa, zaštitu intelektualnog vlasništva i transfer tehnologije između istraživanja i industrije.

Europsko vijeće je usvojilo 2000. godine **Lisbon European Council (2000)** kao sredstvo transformacije EU u najkonkurentnije i najdinamičnije gospodarstvo znanja na svijetu do 2010. sposobno za samoodrživi ekonomski rast, bolju zaposlenost i socijalnu koheziju. Ovaj dokument određuje kao prioritet slijedeća područja: koordinacija inovacijskih politika, regulatorni okvir povoljan za inovaciju, poticanje stvaranja i rasta inovativnih poduzeća, poboljšanje komunikacije unutar inovacijskih sustava, i društvo otvoreno za inovaciju.

2002. godine europsko vijeće usvaja **Barcelona European Council, 2002** prema kojem će se ulaganja u EU u istraživanja udvostručiti na 3 % BDP EU, od čega 2/3 iz privatnog i 1/3 iz javnog sektora s posebnim naglaskom na područje ICT i biotehnologije. Mjereno izdvajanjima za istraživanja i razvoj, sjever se Europe i Velika Britanija zasad u toj preobrazbi pokazuju uspješnijima od ostalih zemalja.

2005. godine Europska komisija usvojila je novi akcijski plan: “**More research and innovation: investing for Growth and Employment - a Common**

Approach” (EC, 2005) u kojem je naglasak na veća ulaganja u istraživanje, na jačanje industrijske baze i snažniju interakciju znanosti i industrije.

Okvirni program (Šesti okvirni program - FP6 od 2002. do 2006. godine, Sedmi okvirni program - FP7 od 2007. do 2013. godine) je među glavnim instrumentima Europske komisije za postizanje lisabonskih ciljeva, kako bi Europska unija postala “najdinamičnija konkurentna svjetska ekonomija temeljena na znanju”. Štoviše, Okvirni program namjerava pretvoriti koncept Europskog istraživačkog prostora (ERA - European Research Area) u stvarnost (slobodno kretanje znanja i tehnologija), smanjujući fragmentaciju europskog istraživanja i poboljšavajući suradnju nacionalnih programa.

7. okvirni program (FP 7) 2007. – 2013. ima proračun od 50 milijardi EUR te je najveći civilni program za financiranje istraživanja i razvoja u svijetu. FP7 donosi 2 novine: a) Osnivanje europskog istraživačkog vijeća (ERC – European Research Council) i uvođenje programa IDEAS kojem je cilj financiranje temeljnih istraživanja vođenih interesima znanstvenika. Za istraživače poljoprivredno-prehrambenog područja najvažnije su sljedeće podcjeline: a) Collaborative research - Zajednička istraživanja (u sklopu specifičnog, b) programa “Cooperation” - “Suradnja; c) Research for SMEs - Istraživanja namijenjena malim i srednjim poduzećima (u sklopu specifičnog programa “Capacities” - “Kapaciteti”); d) Research Potential - Istraživački potencijal (RegPot - u sklopu specifičnog programa “Capacities” - “Kapaciteti”); e) Marie Curie Actions - Marie Curie stipendije (specifični program “People” – “Ljudi”); f) European Research Council - Europsko istraživačko vijeće (specifični program “Ideas” - “Ideje”). Sedmi okvirni program (FP7) je podijeljen na 4 specifična programa (ljudi, ideje, suradnja i kapaciteti) i 13 podcjelina (Kesner-Škreb, 2009). Suradnja: potpora međunarodnoj suradnji u istraživanjima, kojima je cilj jačanje konkurentnosti europske proizvodnje; Ideje: potpora pionirskim istraživanjima u obliku financiranja višedisciplinarnih istraživačkih projekata pojedinačnih timova; Ljudi: potpora daljnjem školovanju, mobilnosti i profesionalnom razvoju istraživača; Kapaciteti: potpora jačanju i optimalnom korištenju istraživačkih i inovacijskih kapaciteta diljem Europe. RH sudjeluje u 75 projekata (1.1.2007. – 15.10.2009.) u koje su uključeni istraživači iz 96 ustanova pri čemu je ukupnu vrijednost projekata = 339,2 mil. kuna. Hrvatska sudjeluje kao punopravna članica u programu (može biti koordinator projekta), za razliku od 6. okvirnog programa gdje je sudjelovala u ograničenom opsegu. Sudjelovanjem u programu, Republika Hrvatska trebala bi ostvariti slične ciljeve u svojim regionalnim okvirima, tj. poticati istraživanja za potrebe gospodarstva Hrvatske, podržati konkurentnost gospodarstva Hrvatske, postati regionalni lider u pojedinim sektorima gospodarstva te potaknuti znanstvenu i gospodarsku izvrsnost Hrvatske.

Tehnološka razina prerađivačke industrije u RH - pokazatelj inovativnosti i gospodarske konkurentnosti

Zaokret u politici EU koji je usmjeren na jačanje interakcije industrije i znanosti, komercijalizaciju znanja, veće ulaganje u znanost te postizanje cilja da EU postane „najkonkurentnije i najdinamičnije gospodarstvo znanja“, razvojni je put koji je kroz vladin Program gospodarskog oporavka iz travnja 2010. godine odabrala i Hrvatska. Hrvatska ima svoje gospodarske i socijalne specifičnosti, a uz aktualnu gospodarsku krizu najvažniji strukturni problemi koji su se sustavno nakupljali u zadnja 2 desetljeća kao posljedica rata, tranzicije, ali i loše ekonomske politike utemeljene početkom 1990-tih godina pod snažnim utjecajem neoliberalne doktrine i tzv. Washingtonskog konsenzusa kojim dominiraju 3 načela: privatizacija, deregulacija i liberalizacija (Domazet, 2009), jesu: a) deindustrijalizacija i b) omjer radno aktivnog stanovništva i zaposlenih te zaposlenih i umirovljenika (1,28:1) koji je pri samom dnu prosjeka EU zemalja. Kao što je prethodno definirano, problem konkurentnosti je u osnovi problem niske produktivnosti koja se može povećati: sniženjem troškova poslovanja te uvođenjem novih proizvoda i tehnologija. Na žalost, u Hrvatskoj je razina produktivnosti uglavnom bila rezultat pasivnog restrukturiranja – smanjenja radnih mjesta koje je s druge strane produciralo nove umirovljenike i stvaralo dodatni pritisak na gospodarstvo, a znatno manje produktivnost je bila rezultat povećanja efikasnosti, novih proizvoda i tehnologija, odnosno inovacija. Inovativnost zemlje određena je kroz kvalitetu interakcije između R&D, potražnje za inovacijama, apsorpcijskim kapacitetom i difuzijom znanja i inovacija putem tržišta i putem netržišne suradnje. Također, u ekonomskoj literaturi općenito se smatra da su visoke tehnologije, (prerađivačka industrija) pokretač gospodarskog rasta i produktivnosti i povezuju se s visokom razinom inovativnosti (Lovrinčević, 2009). Zato kada se uzme u obzir navedeno, povećanje gospodarske konkurentnosti Hrvatske treba tražiti prije svega kroz rješavanje strukturnog poremećaja – deindustrijalizacije. Treba jačati sve segmente inovativnosti zemlje, a posebice, promjenama u sustavu znanosti definiranim u Programu gospodarskog oporavka i većim ulaganjem u primijenjena istraživanja te pojačati kvalitetu interakcije između R&D i potražnje za inovacijama. U ukupnom BDP-u RH prerađivačka industrija od svih 15 sektora ima najveći udio od 17 %, dok je 83 % raspodijeljeno na ostale sektore (Slika 4) (Anić i sur., 2008).

U vanjskotrgovinskoj razmjeni RH, odnosno u izvozu, prerađivačka industrija zastupljena je s 91,4 %, a u uvozu s 85 % dok ostatak čine ostali sektori prema NKD. Međutim, za procjenu utjecaja inovativnosti na razvitak sektora prerađivačke industrije, od samog udjela u BDP-u i vanjskotrgovinskoj razmjeni važniji su podaci o udjelu prerađivačke industrije visoke tehnologije u ukupnom BDV-u (bruto dodanoj vrijednosti) zemlje, promjena vrijednosti bruto proizvodnje u hrvatskoj prerađivačkoj industriji u odnosu na ukupnu promjenu BDV-a te ponuda i potražnja

proizvoda prerađivačke industrije na hrvatskom tržištu. Udio prerađivačke industrije u BDV-u Hrvatske (191,928 mlrd. kuna) iznosi 20,6 % odnosno 50,683 mlrd. kuna pri tome u odnosu na druge dijelove zemlje najmanji BDV i BDV per capita ima Istočna Hrvatska (Mikulić, 2009). Ako se promatra struktura prerađivačke industrije sukladno klasifikaciji OECD-a (Slika 5) prerađivačka industrija visoke tehnologije (prema NKD: 353, 244, 30, 32 i 33) u odnosu na prerađivačku industriju srednje visoke tehnologije (prema NKD: 31, 34, 24 (osim 244), 35 i 29), prerađivačku industriju srednje niske tehnologije (prema NKD: 23, 25, 26, 27 i 28) i prerađivačku industriju niske tehnologije (prema NKD: 15, 16, 17, 18, 19, 20, 21, 22, 36 i 37) zastupljena je u ukupnom BDV-u sa 8,4 % što je značajno niži udio u odnosu na EU-15 gdje napr. Finska ima 25,3 %, Irska 22,6 % ili Mađarska 19,3 %.

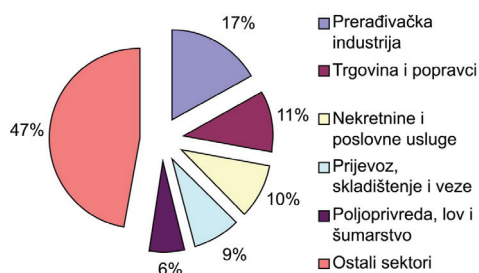

Slika 4. Udio pojedinih sektora prema NKD u ukupnom BDP-u Republike Hrvatske (Anić i sur., 2008)

Fig. 4. Share of individual sectors in Croatia's total GDP according to the National Classification of Activities (Anić et al., 2008)

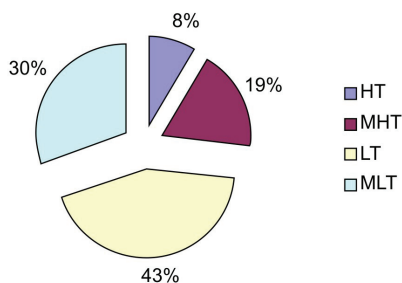

Slika 5. Udjeli u ukupnom BDV-u prerađivačke industrije: prerađivačka industrija visoke tehnologije (HT), prerađivačka industrija srednje visoke tehnologije (MHT), prerađivačka industrija srednje niske tehnologije (MLT) i prerađivačka industrija niske tehnologije (LT) (Mikulić, 2009)

Fig. 5. Shares of the processing industry in total GVA: high-tech processing industry (HT), middle high-tech processing industry (MHT), middle low-tech processing industry (MLT), and low-tech processing industry (LT) (Mikulić, 2009)

Zanimljiv je primjer Mađarske koja je iskoristila nazočnost multinacionalnih kompanija kao potencijalno važnih izvora tehnološkog napretka lokalnih tvrtki i kroz SMARTHUNGARY razvila opsežni sustav podrške i mehanizme koji uključuju aktivnosti istraživanja i razvoja što je i rezultiralo da je HT prerađivačka industrija prema udjelu u BDV-u Mađarske u samom europskom vrhu. Činjenica da ukupna gospodarska aktivnost u RH raste brže od proizvodnje u prerađivačkoj industriji govori o trendu deindustrijalizacije. Također, činjenica da najsporije raste output HT, a najbrže je rastao output MLT ukazuje na nepovoljna kretanja u promjeni industrijske strukture. Najsporija dinamika industrijskog rasta zabilježena je u Zagrebu i Istočnoj Hrvatskoj (Mikulić, 2009).

Ako u desetogodišnjem razdoblju 1997. – 2007. promatramo promjenu strukture BDV-a odjeljaka prerađivačke industrije u RH i EU-25 (Slika 6) može se zaključiti da je HT i MHT u EU-25 porasla najviše, odnosno za 2 %, MLT za 0,8 %, a LT se smanjila za -2,8 % dok je u RH najveći rast pokazala LT i MLT za 2,4 % dok je HT i MHT pala za -4,8 %. Najviše je pao udio proizvodnje kemikalija i kemijskih proizvoda za -4,1 % te proizvodnja prometnih sredstava za -1,2 % koji su u kategoriji HT, odnosno MHT, dok najveće povećanje pokazuju proizvodnja metala i proizvoda od metala +3,2 % i proizvodnja celuloze, papira i izdavaštvo za 4,3 % koji su u kategoriji MLT i LT (Lovrinčević, 2009). Navedeno upućuje na zaključak da hrvatska prerađivačka industrija tehnološki zaostaje te da se tehnološka struktura mijenja na nepovoljan način tako da raste udio proizvodnje proizvoda niže tehnološke osnove, a time i niže dodane vrijednosti. To ukazuje i na gubitak konkurentnosti i sposobnosti proizvodnje više tehnološke razine.

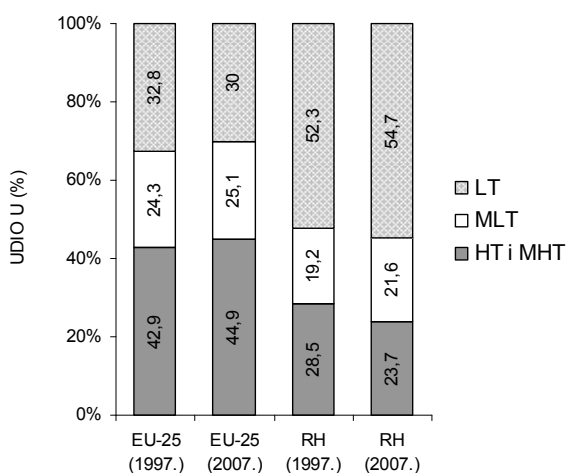

Slika 6. Promjena strukture odjeljaka prerađivačke industrije EU-27 i RH u BDV-u tijekom desetogodišnjeg razdoblja (1997. – 2007.) (Lovrinčević, 2009)

Fig. 6. Changes in the structure of processing industry segments in GVA in EU-27 and Croatia over ten years (1997-2007) (Lovrinčević, 2009)

Usporedimo li ponudu hrvatske prerađivačke industrije prema razini primjene tehnologije (Lovrinčević, 2009) deficit postoji kod svih skupina proizvoda, no najveći je upravo u skupini HT i MHT, dok ako usporedimo potražnju vidljivo je da je hrvatskom tržištu potrebno više proizvoda HT i MHT koje domaća prerađivačka industrija ne može ponuditi što zahtjeva povećanje uvoza. Podaci pokazuju da hrvatski potrošači traže proizvode više tehnološke razine u odnosu na domaću ponudu. Takav višak potražnje u odnosu na domaću ponudu složenijih proizvoda zadovoljava se iz uvoza, te je i deficit u međunarodnoj razmjeni najveći upravo u kategoriji proizvoda HT i MHT, dok domaću potražnju za proizvodima niske tehnološke razine u velikoj mjeri zadovoljava domaća ponuda.

Istraživanje i razvoj u funkciji gospodarske konkurentnosti Hrvatske

Ono što obilježava hrvatski R&D je prije svega nedovoljan udio R&D u ukupnom BDP-u zemlje, koji je u 2008. godini iznosio 0,9 % u odnosu na EU (1,9 %) ili SAD (2,76 %) i Japan (3,5 %) (Slika 7) te nedovoljna suradnja znanosti i gospodarstva koja se najbolje očituje u vrlo niskom udjelu industrije u R&D 44,44 % u odnosu na zemlje EU ili SAD i Japan (Slika 8). To je posebice važan podatak ako se govori o stvaranju novih tehnologija i inovativnosti čije je stvaranje uglavnom vezano za tvrtke, odnosno industriju, a ne uz vanjske organizacije, bile one znanstveno-tehnološki parkovi ili instituti za istraživanje i razvoj.

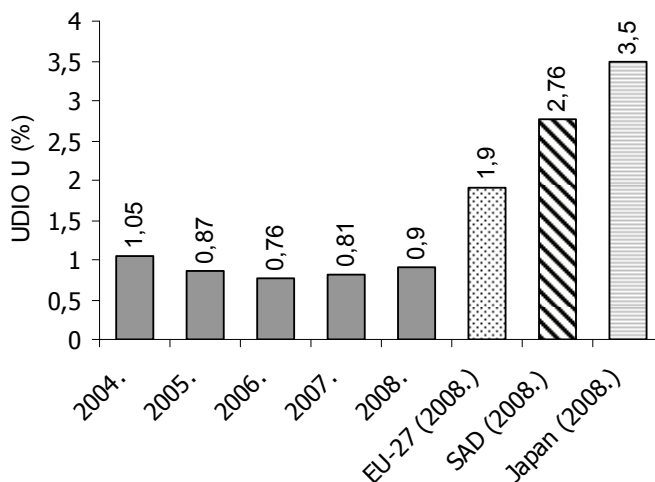

Slika 7. Usporedba udjela R&D u ukupnom BDP-u RH u razdoblju od 2004. do 2008. godine s EU-27, SAD i Japanom za 2008. godinu (MZOŠ, 2010.; Eurostat, 2010)

Fig. 7. R&D share in Croatia's total GDP in the 2004-2008 period in comparison with EU-27, USA and Japan in 2008 (MSES, 2010; Eurostat, 2010)

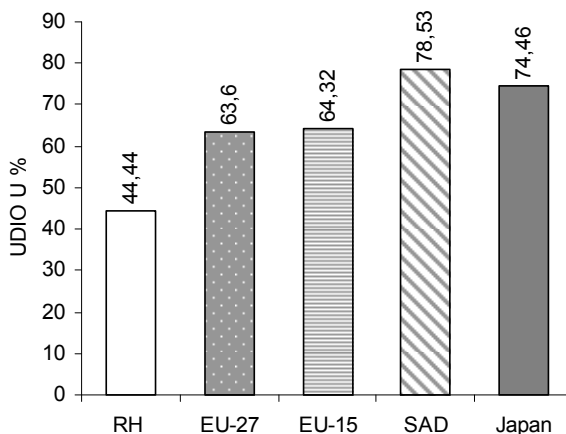

Slika 8. Usporedba udjela industrije u sufinanciranju R&D RH s EU-15, EU-27, SAD i Japanom u 2008. godini (MZOŠ, 2010.; Eurostat, 2010)

Fig. 8. Share of industry in R&D co-financing in Croatia in comparison with EU-15, EU-27, USA and Japan in 2008 (MSES, 2010; Eurostat, 2010)

Značajan problem u analizi i procjeni stanja je način vođenja podataka koji nije kompatibilan EU. Npr. u Hrvatskoj ne postoji centralizirana baza podataka projekata koje sufinancira država (ministarstva te trgovačka društva i agencije vlade), lokalna samouprava, udruge i dr. što je izvor preplaćivanja projekata, višestrukog financiranja istog projekta, nekvalitetne distribucije i dostupnosti rezultata istraživanja industriji i ostalim potencijalnim korisnicima itd. Značajan doprinos suradnji znanosti i gospodarstva i inovacijskoj politici općenito (uz programe unapređenja kvalitete znanosti i visokog obrazovanja te potpora Ministarstva gospodarstva za inovacije, inkubatore i klastere) odigrale su institucije za tehnološki transfer kao što su BICRO, Nacionalna zaklada za znanost, visoko školstvo i tehnološki razvoj RH i HIT preko kojih je do kraja 2009. ukupno odobreno putem programa RAZUM (181 mil. kuna), TEHCRO (56 mil. kuna), IRCRO (8 mil. kuna), KONCRO (1,5 mil. kuna) i HIT-ovog TEST (27 mil. kuna), Nacionalna zaklada za znanost, visoko školstvo i tehnološki razvoj RH (62 mil. kuna) ukupno 336 mil. kuna (MZOŠ, 2010). Kao što je prethodno definirano, inovacija je trajna osnova konkurentnosti, ali nije samo rezultat razvojno-istraživačkog procesa. Prema Eurostatovoj definiciji, tehnološka inovacija uključuje razvoj proizvoda i procesa i dio organizacijskih inovacijskih aktivnosti kao što su marketing i obrazovanje, koji su izravno vezani uz implementaciju novih proizvoda, usluga i procesa. Iz toga proizlazi da se proizvodnost ne mora automatski poboljšati ako zemlja ulaže u istraživanja i razvoj te u inovacije. Sposobnost radne snage da usvaja i prilagođava novu tehnologiju kako bi se povećala proizvodnost ovisi o stupnju obrazovanosti. Stoga se mjere za

poticanje inovativnosti ne smiju zaustaviti na aktivnostima istraživanja i razvoja, već moraju obuhvatiti sve četiri komponente inovativnosti i temeljiti se na sljedećim ciljevima: 1. Inovacijska politika mora biti pretežito tržišno orijentirana i usmjerena k poboljšanju inovativnosti poduzeća - koje je i izvor ponude i izvor potražnje za inovacijama i tehnologijom, te k poboljšanju istraživačko-razvojne i inovacijske infrastrukture. 2. Inovacijska politika mora biti usmjerena prema četirima komponentama inovacijske sposobnosti: apsorpcijskoj sposobnosti, potražnji, difuziji inovacija i aktivnostima R&D. 3. Inovacijska politika mora dovesti do rasta proizvodnosti. 4. Inovacijska politika mora povećati komponentu znanja u svim novim investicijama. Konkretnu razradu ciljeva kroz 55 mjera dalo je Nacionalno vijeće za konkurentnost u dokumentu „55 preporuka za povećanje konkurentnosti Hrvatske“ iz 2004. godine. Razvojno-istraživački proces RH zahtjeva izdvajanje značajnijih financijskih sredstava države. Također, jedini način da ulaganje u R&D doprinese ekonomskom napretku, konkurentnosti i općem boljitku, je da izvozni sektor treba biti osnovni potrošač inovacija i obrazovanja u koje ulaže država. Zbog ogromne zaduženosti koja će krajem 2010. u RH doseći visinu BDP-a, ključan je izvozni sektor, jer on jedini može zatvoriti minus platne bilance. Ukoliko se većina potražnje za ljudskim kapitalom i inovacijama stvori u neutrživom sektoru koji nije izložen međunarodnoj konkurenciji čitava investicija u društvo znanja može se knjižiti kao potrošnja koja će povećavati vanjski dug i biti dodatni teret izvoznom sektoru te će mu umanjiti konkurentnost (Lovrinčević, 2009). Bez potražnje izvoznog sektora za proizvodima društva znanja nema dugoročno održivih radnih mjesta u RH. Takva uloga razvojno-istraživačkog procesa nameće i potrebu snažnije suradnje gospodarstva i znanstvenih institucija, privlačenja ulaganje i stranog kapitala u R&D, ali i snažniju međunarodnu evaluaciju projekata i kvalitetniji monitoring i reviziju.

Umjesto zaključka

Kao posljedica III. znanstveno-tehnološke revolucije uvjetovane razvitkom informacijsko-komunikacijske tehnologije, biotehnologije, automatizacije, kibernetizacije..., klasična ekonomija koja se temeljila na radu, zemlji i kapitalu postala je ekonomija znanja (engl.: knowledge economy) u kojoj ključnu ulogu ima intelektualni kapital koji pretvoren u novu ekonomsku vrijednost (komercijalizacija) kroz tehnologije konkurentne na tržištu (inovacije) uz produktivnost postaje mjera gospodarske konkurentnosti. U najrazvijenijim zemljama svijeta više od polovice BDP-a zasniva se na intelektualnom kapitalu, dok u najjačim svjetskim brandovima (Coca-Cola[®], GE, IBM[®], Microsoft[®], McDonald's[®]...) intelektualni kapital čini više od 75 % ukupne tržišne vrijednosti. EU se krajem 1990-tih godina suočila s tzv. „europskim paradoksom“ odnosno spoznajom da visoka znanost ne proizvodi automatski nove tehnologije i gospodarski rast, zbog čega EU zaostaje za napr. SAD i Japanom, dakle zemljama

koje 2 – 3 puta više iz BDP-a izdvajaju za znanost te u odnosu na EU (64,32 %) imaju značajno veći udio industrije u ukupnom R&D-u (72,4 %, odnosno 78,53 %). Zaokret u politici EU koji je usmjeren na jačanje interakcije industrije i znanosti, inovacije, veće ulaganje u R&D te postizanje cilja da EU postane „najkonkurentnije i najdinamičnije gospodarstvo znanja“, razvojni je imperativ i za Hrvatsku. Jedan od najvećih strukturnih problema Hrvatske uz krajnje nepovoljan odnos radno-aktivnog stanovništva, zaposlenih i umirovljenika je deindustrializacija (ukupna gospodarska aktivnost u RH raste brže od proizvodnje u prerađivačkoj industriji) koja se manifestira kroz nizak udio prerađivačke industrije visoke tehnologije (HT) u BDV-u zemlje od 8,4 % koji, u odnosu na zemlje EU u kojima prerađivačka industrija HT kao indikator inovativnosti i tehnološkog razvoja kontinuirano raste, ima trend pada (u zadnjih 10 godina 4,8 %).

Aktualna gospodarska kriza i strukturna kriza u Hrvatskoj, uz dosljednu provedbu Programa gospodarskog oporavka, zahtijeva jačanje institucionalne logistike za transfer znanja, bolju evaluaciju, monitoring i reviziju projekata te značajnije izdvajanje sredstava za R&D pri čemu bi se trebalo voditi Barcelona European Council-om, (2002) prema kojem bi ulaganja u istraživanja trebala doseći 3 % BDP u odnosu na sadašnjih oko 1 %, od čega 2/3 iz privatnog i 1/3 iz javnog sektora s posebnim naglaskom na područje ICT i biotehnologije. Ulaganja u R&D su važna ne samo da bi se uvodili novi proizvodi i procesi već i da bi se uspješno adaptirali uvezeni proizvodi i tehnologije zbog čega je neophodno cijeli obrazovni sustav prilagođavati tržištu rada.

Prerađivačka industrija posebice HT i MHT usmjerena k izvozu kao indikator inovativnosti i konkurentnosti nacionalne ekonomije, treba postati osnovni potrošač inovacija i obrazovanja u koje ulaže država. S ekonomskog stajališta sredstva uložena u projekte koji nisu izloženi konkurenciji na inozemnom tržištu i orijentirani su prema nacionalnim institucijama, povećavaju ukupnu potrošnju i vrlo ograničeno doprinose ukupnoj konkurentnosti nacionalne ekonomije.

Literatura

- Anić, I.D., Rajh, E., Teodorović, I. (2008): Stanje i perspektive hrvatske prerađivačke industrije. U: Zbornik radova, 17. tradicionalnog savjetovanja hrvatskog društva ekonomista, Bačić, K., Jurčić, Lj., Jurišić, S., Mlinarević, M., Perić, J., Teodorović, I., Vojnić, D. (ur.), Opatija: Inženjerski biro, Hrvatska, str. 131–162.
- Bejaković P. (2004): Konkurentnost hrvatske radne snage u Hrvatskoj: stanje i problemi. U: Konkurentnost hrvatske radne snage, Bejaković, P. i Lowther, J. (ur.), Zagreb, Hrvatska: Institut za javne financije, str. 1-13.
- Bejaković, P. (2005): Kako se Hrvatska priprema za društvo utemeljeno na znanju?. U: Pridruživanje Hrvatske Europskoj uniji – ususret izazovima pregovora, Ott, K. (ur.), Institut za javne financije: Zaklada Friedrich Ebert, Zagreb, Hrvatska, str. 107-125.
- Dabić, M. (2006): Inovacije, inovatori i zaštita intelektualnog vlasništva, Okrugli stol Poticanje poduzetništva s naglaskom na inovacije, Slavonski Brod.

Državni zavod za statistiku.

Družić, G. (2001): Kriza hrvatskog gospodarstva i ekonomska politika, Zagreb Hrvatska, Goleđen marketing, str. 221.

European Commission, 1995, Green Paper on Innovation, EC, Luxembourg.

European Commission, 1996, Action Plan for Innovation in Europe, European Community.

Europska komisija. <http://cordis.europa.eu/en/home.html>

http://epp.eurostat.ec.europa.eu/portal/page/portal/science_technology_innovation/data/database

http://nui.epp.eurostat.ec.europa.eu/nui/show.do?dataset=gba_nabsfin07&lang=en

Kesner-Škreb, M. (2009): Sedmi okvirni program za istraživanje i razvoj – Pojmovnik. *Financijska teorija i praksa*, 33 (3), 375-376.

Kolaković, M. (2003): Teorija intelektualnog kapitala. *Ekonomski pregled*, 54 (11-12), 925-944.

Kotler, P. (2001): Upravljanje marketingom, Zagreb, Hrvatska: Mate d.o.o. Zagreb.

Lovrinčević, Ž (2009): Tehnološka složenost te struktura ponude i potražnje industrijskih proizvoda u Hrvatskoj, *Ekonomski pregled: mjesečnik Hrvatskog društva ekonomista Zagreb* 60 (11), 535-569.

Mikulić, D. (2009): Regionalni razvoj i tehnološka kkonvergencija prerađivačke industrije u Hrvatskoj. U: Zbornik radova, 17. tradicionalnog savjetovanja hrvatskog društva ekonomista, Bačić, K., Jurčić, Lj., Jurišić, S., Mlinarević, M., Perić, J., Teodorović, I., Vojnić, D. (ur.), Opatija: Inženjerski biro, Hrvatska, 131–162, 151–172.

Ministarstvo znanosti obrazovanja i športa.

Nacionalno vijeće za konkurentnost (2004): 55 preporuka za povećanje konkurentnosti Hrvatske“. Zagreb.

Nacionalno vijeće za konkurentnost (2008): Godišnje izvješće o konkurentnosti Hrvatske, Zagreb, Hrvatska.

Romer, P. (1990): “Endogenous Technological Change”, *Journal of Political Economy* 98, 71-102.

Središnji državni ured za razvojnu strategiju i koordinaciju fondova (2006): EU strateški okvir za razvoj 2006.–2013. Zagreb, Hrvatska.

Sundać, D, Fatur, I. (2004): Intelektualni kapital – čimbenik stvaranja konkurentskih prednosti i logističkih poduzeća, *Ekonomski pregled* 55 (1-2), 85-96.

Sundać, D., Švast, N. (2009): Intelektualni kapital - temeljni čimbenik konkurentnosti poduzeća, Ministarstvo gospodarstva, rada i poduzetništva, Zagreb, Hrvatska.

Thurrow, L.C. (1997): Budućnost Kapitalizma, Zagreb, Hrvatska: Mate d.o.o. Zagreb.

Vedriš, M. (2005): Konkurentnost nacionalne ekonomije – osnova izvoznih performansi zemlje, *Ekonomija/Economics*. 12 (1), 37–55.

Commercialization of scientific research in the function of Croatia's competitiveness

D. Kovačević

University of Josip Juraj Strossmayer in Osijek, Faculty of Food Technology Osijek, Franje Kuhača 20, 31000 Osijek, Croatia

Summary

As a consequence of the 3rd Scientific-Technical Revolution caused by the development of ICT, biotechnology, automatization, cybernetisation..., the classical economy that was based on labour, land and capital was transformed into the knowledge economy, where the main role is played by intellectual capital, i.e. by the creative application of knowledge in production. Commercialisation, that is, transformation of knowledge into a new economic value became a benchmark of economic competitiveness. More than half of GDP of the world's most developed countries is based on intellectual capital, whereas intellectual capital accounts for more than 75 % of the overall market value in the most powerful global brands (Coca-Cola[®], GE, IBM[®], Microsoft[®], McDonald's[®]...). At the end of the 1990-ies, the European Union was facing the so-called „European paradox“, that is, the conjecture that high science does not automatically produce new technologies and economic growth, due to which the EU lags behind countries such as the USA and Japan, which allocate 2-3 times more GDP funds to science in comparison with the EU (64.32 %), and where the share of industry in total R&D is significantly higher (72.4 % and 78.53 % respectively). A turning point in the EU policy, which focuses on strengthening interaction between industry and science, commercialising knowledge, increasing investments in science and achieving the objective of transforming the EU into „the most competitive and dynamic knowledge economy“ is a path that Croatia should aspire to. The current economic crisis and structural crisis in Croatia, in addition to economic policy measures, necessitate changes in the education and scientific system, which is not in the function of economic competitiveness to the required extend (e.g. the education structure of Croatia's labour force is not compatible with the requirements of the market, the share of students of natural and technical sciences is relatively low, etc.). In addition, the export sector, in particular the processing industry that has the highest share in exports (91.4 %) should become the main consumer of innovations and education where the state appears as an investor, and this calls for changes in the structure of scientific programmes and projects. Without the demand of the export sector for products of the „knowledge economy“ the entire project will boil down to creating expensive and well-educated labour force for which there would be no sustainable jobs in Croatia over the long term.

Keywords: intellectual capital, innovation, manufacturing, competitiveness

Obrada prehrambenih namirnica visokim tlakovima

UDC: 664.8.03 : 338.45

D. Ježek*, S. Karlović, M. Brnčić, T. Bosiljkov, B. Tripalo

Sveučilište u Zagrebu, Prehrambeno-biotehnološki fakultet, Pierottijeva 6, 10000 Zagreb, Hrvatska

Sažetak

Potreba za konstantnim razvojem i ispitivanjem novih tehnologija obrade hrane koje osiguravaju sigurnost proizvoda i produžuju trajnost, dovela je do ispitivanja mogućnosti primjene visokih tlakova. Tehnologija se pokazala kao vrlo efikasnom kod inaktiviranja bakterija, kvasaca, virusa, i plijesni te se ispituju mogućnosti zamjene ili nadopune klasičnih metodama pasterizacije i sterilizacije. Povišenje tlaka dovodi i do inaktivacije enzima koji kataliziraju kvarenje namirnica, što izravno produžuje trajnost obrađene namirnice. Za razliku od toplinske obrade, primjena visokih tlakova minimalno utječe na kemijska i organoleptička svojstva namirnice, pri čemu se zadržava njezina svježina i tekstura. Iako na tržištu već postoje proizvodi obrađeni visokim tlakom, najveći problem intenzivnije primjene takve metode obrade u prehrambenoj industriji je još uvijek nedovoljan broj znanstvenih istraživanja, čemu doprinosi i visoka cijena laboratorijskih i industrijskih uređaja. Kod proizvođača koji koriste tu tehnologiju vrlo brzo su se pokazale prednosti takve netoplinske obrade namirnica, poput uštede u energiji, radnoj snazi, vremenu i minimalnom utjecaju na okoliš.

Ključne riječi: visoki hidrostatski tlak, inaktivacija mikroorganizama, tekstura

Uvod

Svjetski trendovi u razvoju novih proizvoda sa sobom povlače i potrebu razvoja novih tehnologija za obradu hrane. Izbacivanje ili skraćivanje toplinske obrade namirnica, smanjenje količine aditiva, zadržavanje nutritivnih svojstava, produženje roka trajanja, zahtjevi za uštedom u energiji (vodena para, plin, struja i ostali energenti) kao i drugi faktori predstavljaju sve veći izazov za postojeće tehnologije u prehrambenoj industriji. Tako je došlo do razvoja novih tehnologija obrade hrane kao što su primjena visokog tlaka, ultrazvuka, mikrovalova, pulsnih električnih polja, magnetskih polja, hladne plazme, iradijacije, genetske modifikacije i dr. Navedene tehnologije danas uglavnom služe kao nadopuna postojećim, ali uz konstantna istraživanja i razvoj sve više se koriste i samostalno. Jedan od problema novih tehnologija je i problem prihvaćanja tako proizvedene hrane od strane potrošača. Iradijacija i genetska modifikacija su u svijetu trenutno vrlo nepopularne i neprihvaćene metode

* djezek@pbf.hr

proizvodnje i obrade hrane, dok se primjena visokog tlaka smatra danas najviše prihvaćenom novom metodom obrade (Cardello, 2000).

Novi proizvodi i proizvodi proizvedeni novih tehnologijama uzimaju sve veći udio na svjetskom tržištu. U EU svake godine potroši se 810 milijardi eura na hranu i napitke, s time da je u prošloj godini udio novih proizvoda u prodaji porastao na 88 milijardi eura (prodaja ekološke hrane raste te je trenutno na svega 7 milijardi eura). Kako se u istraživanja i razvoj ulaže 6,4 % od ukupnog prihoda prehrambenih tvrtki, nove tehnologije su prepoznate kao nužnost te uz intenzivan razvoj imaju perspektivnu budućnost.

Teorijski dio

Toplinska pasterizacija ili sterilizacija namirnica i ambalaže danas su najčešće korištene operacije u prehrambenoj industriji kojima se inaktiviraju enzimi te uništavaju bakterije i drugi neželjeni mikroorganizmi. Tim načinima obrade proizvodi se zdravstveno ispravna namirnica koja ima duži rok trajanja, ali dolazi i do nekih negativnih posljedica. Primjerice gube se nutritivni sastojci (vitamini, antioksidanti, denaturacija proteina i dr.), kvare se teksturna i senzorska svojstva namirnice te obično dolazi do potrebe za dodavanjem aditiva. Još jedan problem kod toplinske obrade je veliki utrošak energije, bilo za pogon uređaja, stvaranje topline ili za proizvodnju vodene pare nužne tijekom obrade. Kako bi se izbjeglo navedeno štetno djelovanje na hranu, proizvođači traže način proizvodnje koji bi namirnicu zadržao u prirodnom, svježem obliku, uz eliminaciju mikroorganizama. To je dovelo do razvoja obrade namirnica visokim tlakom. Iako počeci tehnologije i prvi pokušaji njene primjene na namirnice sežu dalje od 100 godina (prvi znanstveni rad na obradi mlijeka visokim tlakom objavio je Hite 1899. godine), intenzivniji razvoj počeo je tek osamdesetih godina prošlog stoljeća. Dotadašnju stagnaciju prekinula je pojava novih materijala koji su puno otporniji na visoke tlakove, nove elastične ambalaže kao i napredak tehnologije. Danas je obrada visokim tlakom jedna od najperspektivnijih tehnologija koja se uz ostalo sve više koristi i kao zamjena ili nadopuna toplinskoj pasterizaciji ili sterilizaciji namirnica i ambalaže. Još jedna potencijalna primjena je i kod obrade proizvoda koji se danas na tržište plasiraju neobrađeni, uz rizik od mikrobiološke neispravnosti i kratki rok trajanja (školjke, razni umaci, plodovi mora, itd.). Iz navedenih razloga obrada visokim tlakom prvenstveno se koristi za inaktivaciju mikroorganizama ili modifikaciju konzistencije namirnica, čime se dobivaju novi, poboljšani proizvodi.

Moderni uređaj za obradu namirnica visokim tlakom sastoji se od metalnog cilindra prikazanog na Slici 1, u kojeg ulazi prihvatna posuda, posude sa tlačnom tekućinom, opreme za upravljanje i nadzor nad postupkom i generatora visokog tlaka (kompresor, intenzifikatori pritiska). Namirnica koju želimo obraditi ubacuje se u prihvatnu posudu te zajedno s njom u cilindar. Cilindar se zatvara i

puni tlačnom tekućinom te se uz pomoć klipa ili konstantnim dodavanjem tekućine povećava tlak u cilindru.

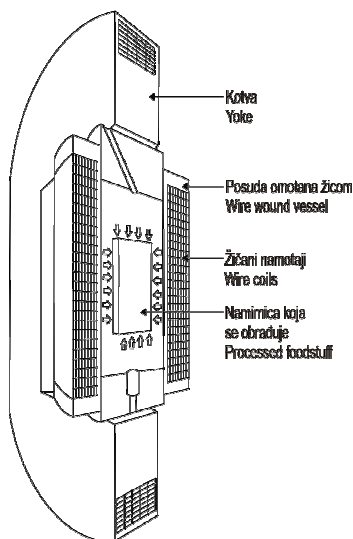

Slika 1. Metalni cilindar sa kotvom korišten za obradu namirnica visokim tlakom.

Fig. 1. Metal vessel with yoke used for treatment of foodstuff with high hydrostatic pressure

Danas se u industriji koriste tlakovi do 800 MPa, dok se u laboratorijskim uvjetima ispitivanja vrše sa tlakovima sve do 1200 MPa, pri čemu temperatura namirnica koja se obrađuje tijekom adijabatskog zagrijavanja minimalno raste (oko 3 °C za svakih 100 MPa). Povišene temperature mogu se izbjeći hlađenjem tlačne tekućine, te ne predstavljaju problem u proizvodnji. Izostanak visokih temperatura tako osigurava nepromijenjeni nutritivni i kemijski sastav obrađene namirnice (Doona, 2007). Za razliku od toplinske obrade gdje postoji gradijent topline po volumenu namirnice, te je temperatura vanjskih dijelova uvijek veća od temperature unutrašnjosti, tlak djeluje rapidno i izostatski, pri čemu je nepromijenjen unutar čitavog volumena. Pod uvjetom da namirnica ne sadrži veću količinu zraka, ne dolazi do njene deformacije (ili je ona minimalna i reverzibilna), te se zadržavaju sva teksturna i druga organoleptička svojstva. Zrak u mjehurićima unutar namirnica poput jagoda ili salata pod visokim tlakom prešao bi u tekuće stanje, čime bi se smanjio volumen mjehurića i omogućila značajnija deformacija proizvoda. U slučaju da se mora zadržati izvorni oblik, takve namirnice ne mogu se obrađivati, ali moguće je na temelju postojećih dobiti nove proizvode koji se ne mogu proizvesti danas uobičajenim metodama (npr. gelovi).

Zakoni i propisi zahtijevaju proizvodnju mikrobiološki ispravnih namirnica, uz ekonomski uvjet dobivanja što dužeg vremena skladištenja. Kao i kod toplinske obrade, za svaku namirnicu i soj mikroorganizama postoje optimalni tlakovi i

vremena obrade koji će ih inaktivirati. Uz veći broj intrinzičnih i ekstrinzičnih faktora, postoji i minimalna razina ispod koje povišeni tlak neće djelovati. Kod nekih spora i prona ta razina je vrlo visoka, te daljnje povišenje tlaka nije isplativo ili izvedivo. Rješenje je u postepenom povišenju tlaka, zadržavanju namirnice na nižim tlakovima (200 – 400 MPa), te nakon aktivacije spora, podizanju tlaka koji djeluje na namirnicu (600 MPa na više). Takav postupak se među ostalim pokazao uspješnim i kod uništavanja spora *C. botulinum*, koje su vrlo otporne na visoke tlakove i visoke temperature (kod toplinske obrade inaktiviraju se sterilizacijom hrane na 121 °C tijekom najmanje 5 minuta) (Doona, 2007). Češće korišteno rješenje je kombinacija sa povišenjem topline, te se uz umjereno visoke tlakove (oko 400 – 600 MPa) i temperature (60 °C) mogu inaktivirati i otporniji mikroorganizmi. Povišene temperature još uvijek nisu dovoljno visoke da bi utjecale na nutritivni sastav. Uz povišene temperature, koriste se i niske temperature, od -20 °C do 15 °C, koje su se u nekim slučajevima (*S.Aureus*) pokazale kao efikasnije. Gram pozitivne bakterije su zbog svoje jednostavnije strukture otpornije na povišenje tlaka, te se primjerice *Staphylococcus Aureus* uspješno inaktivira tek uz primjenu blagih temperatura. *Salmonela spp.* i ostale gram pozitivne bakterije inaktiviraju se već pri nižim tlakovima, što je prikazano na Slici 2. Pri tome se prilikom obrade koristi namirnica već pakirana u fleksibilnu ambalažu, te ne postoji mogućnost rekontaminacije.

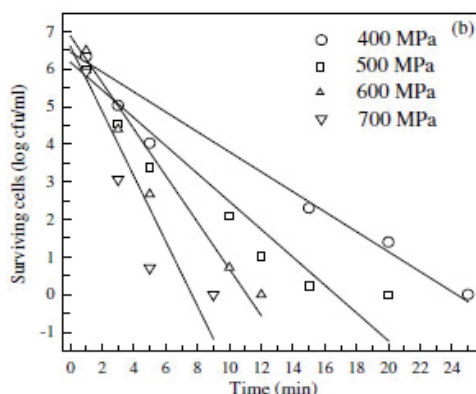

Slika 2. Inaktivacija *Listerie monocytogenes* tlakovima od 400 do 700 MPa (Dogan i Erkmen, 2004).

Fig. 2. Inactivation of *Listeria monocytogenes* with pressures from 400 to 700 MPa (Dogan and Erkmen, 2004)

Za razliku od bakterija, kvasci i plijesni su daleko manje otporni na obradu, što dovodi do njihovog brzog uništenja već pri nižim tlakovima. Kako su kvasci odgovorni za kvarenje namirnice, pri čemu su otporni na visoke koncentracije organskih konzervansa, tehnologija obrade visokim tlakom pokazala se vrlo efikasnom za produženje roka trajanja namirnice. Plijesni su također nepoželjne

zbog svoje potencijalne toksigeničnosti te je njihovo uklanjanje nužno radi zdravstvene ispravnosti namirnice (Brennan, 2006). Zbog inaktivacije enzima, plijesni i kvasaca, voće i povrće obrađeno tlakovima od 400 MPa u trajanju 3-4 minute ima znatno duži rok trajanja, od 6 mjeseci na više. Za razliku od toplinskih metoda obrade može se zaključiti da obrada visokim tlakom ne utječe na fenole, antocijanine, askorbinsku kiselinu i druge antioksidante, što je ispitivano do tlakova od 700 MPa (Patras i sur., 2009). Istraživanja na vitaminima pokazala su da su gubici minimalni (do 5 %), dok na minerale nema utjecaja.

Obrada utječe na nekovalentne veze (vodikove, ionske i hidrofobne), što dovodi do razmatanja proteinskih lanaca, nema utjecaja na kemijske i nutritivne tvari koje su povezane sa pozitivnim svojstvima namirnice poput okusa, mirisa i nutritivnog sastava (Ahmed i sur., 2010). Voćni sokovi zadržali su svoj izvorni svježi okus i miris, uz uništenje patogenih bakterija i prirodne flore, što se manifestira kroz produženi rok trajanja takvog proizvoda (Barbosa-Canovas, 2005).

Tekstura gotovog proizvoda mora biti u skladu sa zahtjevima potrošača, pri čemu namirnice sa teksturom koja odstupa od očekivane (smanjena tvrdoća, elastičnost, povećan rad potreban za žvakanje, adhezivnost i dr.) neće proći na tržištu. Zbog toga je vrlo važno da se nakon obrade proizvoda (posebice voća, povrća i mesa) maksimalno zadrži tekstura svježe namirnice. Obrada visokim tlakom mijenja fizikalno-kemijska svojstva matrice unutar voća i povrća i dovodi do promjene u permeabilnosti stanica, što može dovesti do njihovog pucanja, kolapsa parenhimskog tkiva i drugih neželjenih posljedica, kao što je prikazano na Slici 3. Ipak, uz optimalno podešene parametre takav način obrade ima minimalan utjecaj, za razliku od značajnih strukturalnih promjena nastalih tijekom toplinske obrade.

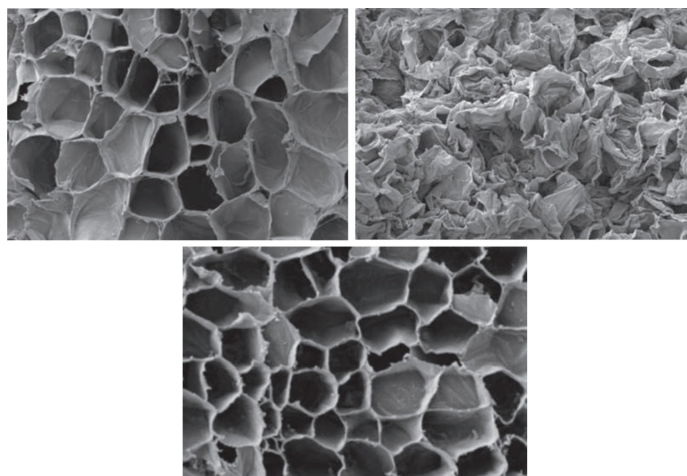

Slika 3. SEM mikrografi neobrađene mrkve, toplinski obrađene pri 105 °C, te obrađene pri 700 MPa uz povišenu temperaturu (Nguyen i sur., 2008).

Fig. 3. SEM micrographs of untreated carrot, treated with heat at 105 °C and treated with 700 MPa and increased temperature (Nguyen et al, 2008)

Uz osiguranje sigurnosti hrane i produženje roka trajanja, danas najveći izazov kod obrade namirnica visokim tlakom je razvoj ambalaže, koja mora zadovoljavati više kriterija. Osnovno svojstvo koje se gleda kod ambalaže prije primjene u visokotlačnoj obradi namirnica je njena elastičnost. Usljed djelovanja tlakova na površinu, dolazi do deformacije materijala te je nužno da podnaša deformacije do otprilike 15 % te se nakon toga vrati u prvobitni oblik bez gubitaka svojstava. Veličina deformacije ovisi o smanjenju volumena tekućine, tj. o primijenjenom tlaku. Zbog toga su staklo i drugi kruti materijali nepovoljni za ambalažiranje namirnica, no ipak se mogu upotrijebiti kombinacijom sa drugim elastičnim materijalima i uklanjanjem zraka. Ipak, danas najkorišteniji materijal je plastika, i to specifično elastični PVC i PE. Kod plastike najveći problem je delaminacija, tj. odvajanje slojeva, što kasnije može dovesti do kontaminacije namirnice u ambalaži u slučaju da je tako omogućen dostup zraku.

Kako je cijena postrojenja koje koriste nove tehnologije obrade namirnica obično vrlo visoka, velika prepreka uvođenju visokotlačne obrade u prehrambenu industriju je visoki inicijalni trošak zbog skupe opreme. Niža cijena konvencionalnih metoda vrlo brzo se anulira kroz manje troškove održavanja, a pogotovo zbog značajne uštede u energiji u odnosu na pasterizaciju i sterilizaciju. Ušteda je prisutna i zbog kraćeg vremena tretiranja te uklanjanja potrebe za vodenom parom, te investicija u visokotlačnu obradu namirnica vrlo brzo postaje isplativa. Tehnologija je ekološki čista, nema otpadnog materijala, te zbog kvalitetnog gotovog proizvoda danas postoji sve više velikih proizvođača prehrambenih proizvoda koji su napustili klasičnu pasterizaciju te uspješno tretiraju voće, mlijeko, školjke, meso i druge namirnice.

Literatura

- Ahmed, J., Ramaswamy, H.S., Kaspis, S., Boye, J.I. (2010) Novel Food Processing – Effects on Rheological and Functional Properties. CRC Press, New York, SAD.
- Brennan, J.G. (2006) Food Processing Handbook. Wiley-VCH, Weinheim, Njemačka.
- Barbosa-Canovas, G.V. (2005) Novel Food Processing Technologies. CRC Press, New York, SAD.
- Cardello, A.V. (2000) Consumer attitudes and expectations toward non-thermal and other novel food processing techniques. Presentation at the IFT Non-thermal Processing Division Workshop on Non-thermal Processing of Food. Portland, SAD.
- Dogan, C., Erkmen, O. (2004) High pressure inactivation kinetics of *Listeria Monocytogenes* inactivation in broth, milk, and peach and orange juices, *Journal of Food Engineering* 62(1), 47-52.
- Doona, C.J., Feeherry, F.E. (2007) High pressure processing of foods. Blackwell Publishing, SAD.
- Hite, B.H. (1899) The effect of pressure on the preservation of milk. West Virginia Agricultural Experimental Station Bulletin 58, str. 15–35.

- Nguyen, L. T., Rastogi, N. K., Balasubramaniam, V. M. (2007) Evaluation of instrumental quality of pressure - assisted thermally processed carrots, *Journal of Food Science* 72, 264–270.
- Patras, A., Brunton, N.P., Da Pieve, S., Butler, F. (2009) Impact of high pressure processing on total antioxidant activity, phenolic, ascorbic acid, anthocyanin content and colour of strawberry and blackberry purees, *Innovative Food Science and Emerging Technologies* 10, 308-313.

Food processing with high pressure

D. Ježek, S. Karlović, M. Brnčić, T. Bosiljkov, B. Tripalo

*University of Zagreb, Faculty of Food Technology and Biotechnology, Pierottijeva 6,
10000 Zagreb, Croatia*

Summary

Main purposes of new methods and technologies in the food industry are enhancement of process control and monitoring, standardization and establishment of new production norms, preparation of raw materials and production of final products. Implementation of the new technologies and methods such as magnetic fields, ultrasound, microwaves and high pressure already gradually started, and most of novel technologies are in some way applied in different industrial production processes. These technologies and methods lead to improvement in control of production processes and control of food safety, which are introduced in food and chemical industry and biotechnology, as well as in their control laboratories. Some of the fields in which mentioned technologies are used are food preservation, inhibition of microbial growth, pasteurization and sterilization of products, polymer production, etc. Among other things, they are also used for improvement of drying process, detection of foreign bodies in raw materials and final products, crystallization processes, nitrogen removal, colour stabilization, homogenization, cleaning, sieving, freezing, enzyme deactivation in microorganisms, extending shelf life of products, preparation and production of new products. This procedures and methods are implemented as standards in the quantitative and qualitative production, but also in control of foodstuff and final food products in industry and validated analytical laboratories. In this manner, procedures for preparation and using of new technologies are defined, which enhance process control, quality control and safety of final products.

Keywords: high hydrostatic pressure, inactivation of microorganisms, texture

Novel food pathogen testing technologies: molecular biology methods

UDC: 641 : 579.61

A. Stjepanovic*, H. Marit Østlie, S. Borghild Skeie

Norwegian University of Life Sciences, Department of Chemistry, Biotechnology and Food Science, As, Norway

Summary

Food borne pathogens and spoilage bacteria are influencing the safety and quality of foods and can cause serious adverse effects to human and animal health as well as to the food quality. Consequently, microbiological quality control in the food industry has become the priority of the food producers and it aims towards minimizing the risks connected to food pathogens and spoilage bacteria. Conventional methods, used solely until recently for food testing, have had many obstacles in the terms of the time needed for their application as well as their accuracy. They often involve utilization of suitable media for the pre-enrichment and enrichment, isolation of the pathogens on selective media and their confirmation by the employment of morphological, biochemical and/or serological testing. These methods require intensive work, longer time and, however, obtained results often can be false considering the presence of viable but not cultivable microorganisms. Development of biotechnology and bioinformatics has resulted in the development of novel testing technologies that enable tracking, more reliable and faster detection of food pathogens. Furthermore, molecular-biology methods, although still not applied routinely in everyday practice, are the promising alternative that can replace or be auditioned to current reference methods in this area.

Keywords: food borne pathogens, molecular biology methods, rapid tests, biosensors

Introduction

Illnesses caused by food poisoning are endangering public health worldwide and represent one of the major health problems (Wallace et al., 2000). The incidence of foodborne illness is highly increased with intensified trade globalization, increased transport and significant changes in food consuming habits (Käferstein et al., 1997). Nowadays there is over 200 different diseases occurring as a consequence of consumption of the microbiologically unsafe foods and their symptoms varying from mild gastroenteritis to the life threatening syndromes that endanger the life of the consumers with the possibility of chronic complications (Mead et al., 1999).

Detection of food spoilage and pathogenic bacteria in food represents a challenge due to the fact that these microorganisms are present often in low numbers in the food matrix and are outnumbered by indigenous bacteria.

* aleksandra.stjepanovic@umb.no

Conventional/classical microbiology methods employ the utilization of nonselective pre-enrichment media, selective enrichment media, and consecutive confirmation via morphological, biochemical and/or serological tests. Therefore, these methods are laborious, time consuming and are not always completely reliable (eg. in detection of some viable but not culturable - VBNC bacterial species). In the aim of overcoming of these obstacles a number of alternative, fast detection methods have been developed for identification and quantification of the food pathogens. This is of high importance for the food production industry since it requires faster methods for obtaining of the adequate information on possible presence of food borne pathogens for the purpose of production control and monitoring of hygienic practice in the facilities. These fast methods provide early detection and enumeration of microorganisms and can be divided into modified and automated conventional methods, bioluminescent, immunological and molecular methods (Fung, 2002; Scheu et al., 1998).

Essays based on nucleic acid detection

Molecular methods, currently applied for the detection of foodborne microorganisms are, in most cases, based on hybridization of nucleic acids or Polymerase Chain Reaction - PCR. These methods can detect specific parts of DNA or RNA molecules. DNA isolation and detection techniques are simpler in comparison to those dealing with RNA. However, there is a high possibility that DNA - based techniques can give positive results also when detecting dead and/or inactive bacterial cells. Therefore, the detection of dead and/or inactive foodborne pathogens or spoilage bacteria represents the main problem in direct application of the PCR techniques for food analysis, especially in the assays that don't involve pre-enrichment steps. On the other hand mRNA, although is less stable in comparison to DNA, offers a bigger potential for more specific detection of live cells of foodborne pathogens.

Depending on desired specificity of detection (genus, species or strains specificity) different parts of the genome can be used as a target sequences (Scheu et al., 1998).

Nucleic acid hybridization

Nucleic acid hybridization represents a relatively fast screening technique for detection of foodborne pathogens. This method can also be used for detection of target pathogens in the pre-enrichment medium. The principle of the reaction is based on the hybridization of the DNA or RNA molecules in the target organism with DNA probe that has the complementary sequence. DNA probes usually contain 15-30 nucleotides (de Boer and Beumer, 1999). Specificity of the hybridization assay is completely controlled by the nucleotide sequence of the probe. First step encompass cell lysis and purification in order to obtain free

nucleic acid that can hybridize with the probe. Product of the hybridization can be detected with various techniques. Direct hybridization employs radioactive and fluorescent probes for the hybridization of the nucleic acids in the sample. Indirect detection is done by enzyme reporters on solid media-membranes (nitrocellulose or nylon) and polymer particles. In this purpose the most often used formats are Southern blot and Dot blot in which the target nucleic acid is immobilized on the membrane, after the separation on electrophoresis gel (Southern blot) or directly from the solution (Dot blot) (Barbour and Tice, 1997). Today, there are several commercial systems for pathogen detection available on the market such is Gene-Track that utilizes pathogen-specific probes for annealing to the bacterial rRNA and colorimetric system for detection of the specific probe-rRNA hybrids (de Boer and Beumer, 1999). RNA molecules are often used as a target for hybridization due to the fact that they offer high sensitivity since there is a significant number of target sequence copies (>1000) in a single bacterial cell. Lack of this rRNA based method lies in its limited specificity. Closely related species (e.g. *Listeria monocytogenes* and *Listeria innocua*) share highly similar rRNA sequences and therefore their discrimination is not possible (de Boer and Beumer, 1999).

Amplification methods

Molecular methods, involving amplification step, are becoming more popular due to their higher sensitivity. The most applicable method is Polymerase Chain Reaction - PCR. During eighties and nineties in the last century, PCR has become widespread method for food pathogen detection (Chen, 2003). At the beginning, PCR assays were used only in the research laboratories, but in the last years many companies have developed commercial PCR systems for food pathogen detection such are those for *Listeria monocytogenes*, *E.coli* O157:H7 and *Salmonella* sp. (Scheu et al., 1998). These methods are more specific in comparison to the conventional, biochemical ones.

In the everyday practice we are often facing the fact that different food components, growth media and reagents used for the isolation of nucleic acids can have negative impact or even block the amplification reaction. These components are generally known as amplification inhibitors (Rossen et al., 1992). Known inhibitors are food constituents (organic and phenol components, glycogen, fat and calcium ions), environmental inhibitors (phenol components, heavy metals), bacterial cells constituents, non-target nucleic acids as well as inhibitory components originating from the laboratory environment. Therefore, it is necessary to perform sample preparation- pre-amplification- to conduct the characterization and removal of the inhibitory components. This represents an important step in sample preparation in order to ensure the preciseness of the reaction (Wilson, 1997). The purpose of the pre-amplification is the increasing of the concentration of target organism up to the acceptable level for given

method and to reduce or eliminate inhibitory substances. Pre-amplification procedures can be biochemical, immunological, physical or physiological (Rådström et al., 2003). The most often used amplification methods are PCR, RTi-PCR, MPCR and NASBA.

PCR is simple, adjustable, sensitive, specific and reproducible assay. Every PCR cycle has three phases (denaturation, elongation and termination) and there is, in average, around 30 of such cycles in one PCR reaction (Fig. 1). This assay employs the utilization of DNA polymerase, enzyme that amplifies specific fragments of the DNA molecule, short and sequence-specific oligonucleotide added to the reaction (Powledge, 2004). These nucleotides are named primers and contain the sequences complementary to the target sequences of the DNA molecule (Table 1). First and most often used enzyme is Taq DNA polymerase (isolated from the bacterial species *Thermus aquaticus*) but the Pfu DNA polymerase is also often used (isolated from *Pyrococcus furiosus*) due to its high reliability of copying of the DNA sequence. Although these two enzymes are different they possess some mutual features that make them applicable in the PCR reaction: they can generate new chains of DNA using the information in the template DNA sequence and primers, and are, which is of high importance, thermo stable (Valasek and Repa, 2005).

Table 1. DNA primers used for the detection of food pathogens in PCR reaction

Organism	Target sequence	PCR product	Reference
<i>Listeria monocytogenes</i>	listeriolysine O	520 bp	Mengaud et al., 1990
<i>Salmonella spp.</i>	1.8 kb HIND III	1179 bp	Tsen et al., 1994
<i>Campylobacter jejuni</i>	flagellar A gene	450 bp	Oyoyo et al., 1992
<i>E.coli O157:H7</i>	H7, O157, eaeA, etilA, vt1, vt2 gens	multiplex	Paton and Paton, 1998

Thermo stability is necessary due to the fact that at the beginning of every PCR cycle double DNA helix is denaturated to single strand form (“it is melted”) by the application of high temperature in the reaction tube (93-96 °C). Temperature at which half of the DNA molecules become single-stranded is named as melting temperature (T_m). Second phase of the PCR cycle is the primer annealing to the specific complementary sequences of the target single-stranded DNA molecule. Primers suppress the re-annealing of the single DNA strands and enable DNA polymerase to start the synthesis of a new strand. This is the primer annealing phase and it is performed at 65-75 °C. Third phase is the elongation phase (at approximately 72 °C) which involves binding of the nucleotides from the reaction mixture to the complementary ones of the target sequence. After that, primers are displaced resulting in creation of two copies of target DNA segment.

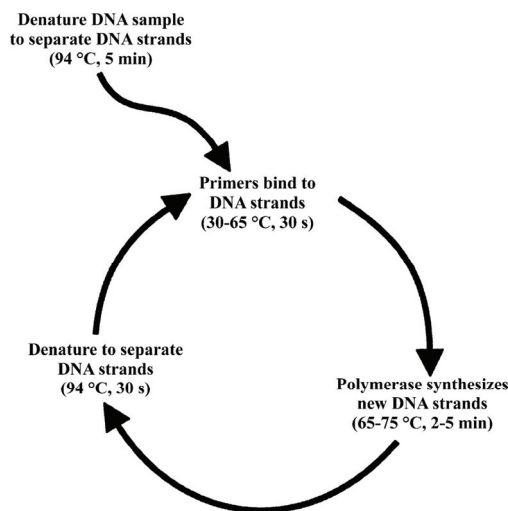

Fig. 1. The cycle of the PCR reaction (taken from Powledge, 2004)

PCR method enables the amplification of the genes specific for certain taxonomic bacterial group as well genes responsible for virulence of the pathogenic microorganisms (Bej et al., 1994). Rapid identification of the bacterial strains by PCR doesn't require pure cultures as this is the case with conventional microbiological methods (Rasmussen et al., 1994).

Lacks of the PCR method are related to impossibility of differentiation between DNA molecules originating from live or dead cells, impossibility of obtaining the quantitative information (Rodríguez-Lázaro and Hernández, 2006), as well as the time necessary for making the gels to confirm presence/absence of foodborne pathogens (Fung, 2002). Furthermore, all of the commercially available PCR assays still require sample pre-enrichment since this decreases the risk from false positive results - detection of dead microorganisms. Another significant component of these commercial assays is introduction of the internal positive controls that are indicating PCR lacks.

Multiplex PCR (MPCR) represents the method used for simultaneous identification of the several gene sequences belonging to the same pathogen or originating from the mixture of different microorganisms (Chamberlain et al., 1988). Main advantage of the multiplex PCR in comparison to the conventional one is its lower price. It is primarily related to decrease of the reagent utilization, such is Taq DNA polymerase. Another advantage of the MPCR in routine diagnostics in comparison to the systems, in which several pathogens are analyzed individually, is also in shorter time required for the sample preparation and obtaining of the results. Reaction mixture in these systems often has more than four primer pairs.

In order to ensure the system specificity it is necessary to design the primers longer than those used in conventional PCR and which are characterized by higher melting temperature (T_m). Magnesium concentration, beside its influence to the reaction specificity, is one of the most significant factors in PCR reaction which determines its efficiency (McPherson and Møller, 2000). Generally, in MPCR $MgCl_2$ concentration is higher than that used in conventional PCR reaction. MPCR usually detects 16S rRNA genes (Rosselló-Mora and Amann, 2001). This gene is sometimes insufficient for discrimination of closely related species (Normand et al., 1996; Torriani et al., 2001), and therefore other genes are also detected to ensure specificity of the MPCR reaction.

Real-time PCR (RTi- PCR) is another technique based on the PCR reaction. Essential advantage of the RTi- PCR lies in the fact that it precisely differentiates and measures specific DNA sequences in the sample although these are quantitative very small. At the same time system monitors the synthesis of new molecules during the PCR reaction in the real time by the employment of fluorescent technology (Heid et al., 1996, Lazcka et al., 2007). Therefore, data are collected in the course of the PCR reaction-not only at its end. To enable the monitoring of the PCR reaction in the real time, the fluorescent probes are used in the PCR reaction. There are several such probes currently available on the market and some of them are DNA binding dyes (EtBr or SYBR green I), sequence-specific fluorescent oligonucleotide probes (TaqMan probe), hybridization probes, etc. (Valasek and Repa, 2005).

Every of these probes have its own specific characteristics but their mode of action is quite simple. In principle, they change the fluorescence intensity during the DNA amplification process. SYBR Green I emits thousand times higher fluorescence when it is banded to double-stranded DNA in comparison when it is free in solution. Therefore the SYBR Green fluorescent signal will be higher if the target DNA sequence amount in the sample is also higher. Main advantages of the RTi-PCR is the fact that it is performed in a closed tube which significantly decreases cross-contamination risk, the analysis is fast and simple, quantification scope is extremely wide and the reliability of the results is significantly higher when compared to the conventional PCR reaction (Valasek and Repa, 2005, Lazcka et al., 2007).

The most significant achievement of the RTi- PCR technology is its ability of detection of the fluorescent signals and recording of the PCR reaction cycles. It is necessary to provide the excitation energy and detection of the emission wavelength. The excitation energy is provided trough special lamps, light diodes or by laser while detection is done trough different types of photo detectors. Furthermore, to enable PCR reaction it is also necessary to have a thermal cycler that achieves desired temperature by suitable airflow. This is another feature of the RTi-PCR which differentiates it from the conventional PCR where the temperature increase is achieved with thermo-blocks, so the process of heating and cooling also goes slower. For reasons of comparison the termination of 40 PCR cycles in RTi-PCR-a

lasts for about 30 minutes, while the same number of cycles in conventional PCR is performed in 1h and 45 minutes (Edwards et al., 2004). Naturally, Real-time instrumentation wouldn't be complete without suitable computer hardware as well as the software for collection and analysis of obtained data.

Results obtained in RTi-PCR are comprised out of amplification curves that can be used for quantification of the initial amounts of sample DNAs with high precision and wide range of concentrations (Schmittgen et al., 2000). Amplification curve typically represents three different phases. (Fig. 2). First, or initiation phase is done during the first PCR cycle where the emitted energy cannot be differentiated from the base line, followed by the exponential or log phase that follows the fluorescence increase and final, stationary phase in which the reagents are exhausted and there is no fluorescence detection (Rodríguez-Lázaro and Hernández, 2006).

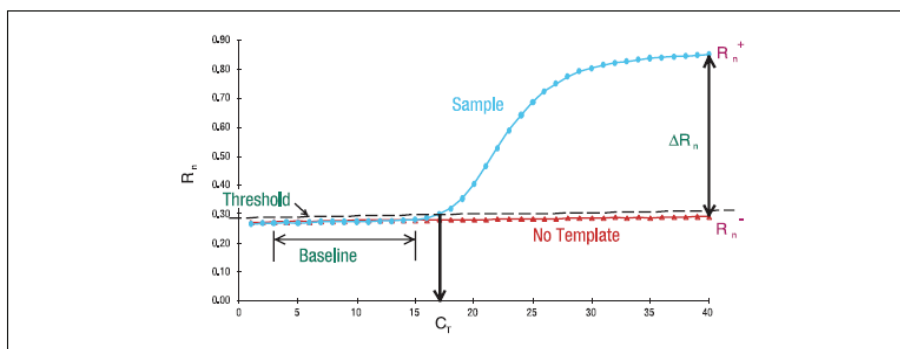

Fig. 2. Amplification curve for RTi-PCR (adapted from Higuchi et al., 1993)

Amplification of the nucleic acid sequences - NASBA (Nucleic Acid Sequence Based Amplification) is described for the first time in 1991 (Compton, 1991). It is used for the continual amplification of the nucleic acids under isothermal conditions. NASBA represents sensitive system based on transcriptive amplification adjusted for the detection of RNA molecules (Deiman et al., 2002). In such reaction, three different enzymes are used for the amplification of a single stranded RNA molecule (Rodríguez-Lázaro and Hernández, 2006). Reaction also involves two oligonucleotide primers that are complimentary to the target RNA region, deoxyribonucleotide tri-phosphates for the activity of AMV reverse transcriptase and ribonucleotide tri-phosphates for the activity of T7 RNA polymerase. Reaction is performed at 41 °C and lasts for 1-2h. At this temperature the genomic DNA stays double stranded and therefore cannot replace the amplification substrate. In the course of NSBA reaction 10-100 copies of target RNA sequence is generated in each of the cycles and after 4-5 cycles

approximately 1 million copies of the target sequence is created (Compton, 1991). The number of cycles in the NASBA reaction is significantly lower in comparison with conventional PCR methods where it is necessary to have approximately 20 cycles to obtain 1×10^9 molecules per reaction (Chan and Fox, 1999).

Considering the fact that NASBA, same as other molecular techniques, is an instrumental technique it can also give false positive results (Knowk and Higuchi, 1989). The most obvious cause of the occurrence of false-positive results is accidental sample or reagents contamination (cross-contamination) in the laboratory. This problem can be overcome by the implementation of internal controls of amplification- IAC (Internal Amplification Controls) (Hoorfar et al., 2004). IAC represent no target sequences of nucleic acids that are simultaneously amplified with target sequence (Cone et al., 1992). When the reaction is also supplemented with IAC it will always give control signal even if there is no target sequence present in the sample (Rodriguez- Lazzaro and Hernandez, 2006). If the signal is not registered the reaction failed.

NASBA technique represents the promising diagnostic tool for the detection of viable microorganisms because it is based on detection and amplification of RNA molecule. Since NASBA has the same speed and accuracy as PCR, and in addition has advantage of detection of live pathogens it represents promising laboratory method in food microbiology.

Molecule sub-typing methods

Sub-typing methods are used for strain (subtypes) differentiation of spoilage and pathogenic bacteria in food and very often are applied in the laboratory practice more often due to the fact that these methods are fast, precise, efficient and help in the process of monitoring of foodborne disease transmission. Generally, methods of bacterial sub typing can be divided into those based on phenotype and molecular-genetic, DNA based methods (Wiedmann, 2002).

Most often used DNA-based sub typing methods include plasmid profiling, Pulsed Field Gel Electrophoresis (PFGE), Ribotyping, Amplified Fragment Length Polymorphism (AFLP), Random Amplification of Polymorphic DNA (RAPD) as well as other methods such is e.g. Multi Locus Sequence Typization (MLST). These methods enable sensitive discrimination of the strains and higher standardization and reproducibility levels in comparison to the phenotype-based methods (serotyping, biotyping, multilocus enzyme electrophoresis) (de Boer and Beumer, 1999; van Belkum et al., 2001).

Pulsed Gel Field Electrophoresis - PFGE is characterizing the bacteria into subtypes giving suitable DNA sequences after the digestion of bacterial DNA by restriction enzymes. In the course of this procedure, bacterial DNA is isolated and cut by enzymes into DNA fragments. These enzymes cut DNA at the places where short, specific sequence is present. Restriction enzymes give 8-25 bands of the DNA molecule containing 40-600 kilo base pairs. (Weidmann, 2002).

Considering the fact that the fragments of DNA molecule of this size cannot be separated by standard electrophoresis techniques, a special electrophoresis technique is used. In the course of electrophoresis the direction of electric field is changed and the separation of DNA fragments is achieved. These are, later on, visualized by ethidiumbromide staining. Fragments are compared with the existing database for determination of similarity degree of examined with already analyzed strains. During the continual electrophoresis, DNA fragments of more than 30-50 kb migrate with the same speed, no matter of size and this is observed as one diffuse band on the gel. However, if the DNA fragments are “forced” to change the direction during the course of electrophoresis, fragments of different sizes will be separated. With every new re-orientation of the electric field, smaller DNA fragments will start to move in the new direction faster than those of higher molecular weight. Therefore, bigger DNA fragments will be retained at the beginning of the gel ensuring the separation of smaller DNA fragments.

PFGE sub typing exhibits high discrimination level in food pathogen detection and therefore it represents gold standard in laboratory diagnostics (Swaminathan and Feng, 1994).

Ribotyping is another DNA-based sub typing method in which bacterial DNA is firstly cut into the fragments with restriction enzymes. Differently from the restriction enzymes used in PFGE reaction, which cut DNA in bigger fragments, in the ribotyping reaction genomic DNA is cut into high number of smaller fragments (more than 300-500) 1-30 kb in size. Obtained fragments are separated according to their size by agarose gel electrophoresis. In the following, Southern blot step DNA probes are specifically bind to DNA fragments that contain genes coding rRNA synthesis. Therefore, target fragments are only those DNA fragments containing r RNA genes (Bruce, 1996).

Amplified Fragment Length Polymorphism - AFLP represents another genotyping technique based on selective amplification of restriction fragments of the DNA molecule (Vos et al., 1995). Technique involves three steps: cutting of the DNA and binding of oligonucleotide adapters, selective amplification of restriction fragments sets and electrophoresis of amplified fragments. Method enables simultaneous analysis of 50-100 restriction fragments on denaturing polyacrylamide gel.

Biosensors

Biosensors are devices that detect biological or chemical complexes and are based on antigen-antibody, enzyme-substrate or receptor-ligand principle. Most of the biosensors designed for food pathogen detection have been tested solely on the pure bacterial cultures (Lazcka et al., 2007). For these applications, pathogens are firstly isolated from the food matrix and then subjected to the analysis by biosensors. There were several attempts of isolating pathogens directly from the food matrix but this still represents a challenge. Furthermore, populations of the target microorganisms are extremely small in comparison to

those naturally occurring in foods. Therefore, different strategies for detection of such a small number of pathogens directly from the food are applied.

Surface Plasmon resonant sensor is the optical sensor that has the ability to detect the moment of biomolecule binding in the real time (few seconds or minutes) via detection of the differences in the intensity of the light reflected from the excited surface. When there is binding it conditions changes in the light refraction angle from the medium resulting in creation of the signal. Although this method is mostly used for the detection of live cells of *E. coli* O157:H7, *Salmonella* and *Listeria*, it has the application in the detection of small toxin molecules such as staphylococcal and botulinum toxins (Pimbley et al., 1998).

DNA biosensors are being applied after discovering of very interesting chemical and physical features of the DNA molecule. DNA biosensor is the diagnostic device that immobilizes single-stranded DNA at suitable matrix in the aim of detection of the hybridization signal after its exposure to complementary DNA molecule (Lu et al., 2000; Mandrell and Wachtel, 1999). Target microorganism can be detected by hybridization of the specific sequence at the surface of transducer (Davis et al., 2005). Although there are certain dilemmas on the origins of the conductivity of DNA molecule it has been concluded that DNA can serve as an elegant model for one-dimensional electron transport (Kavita et al., 2006). There is a high number of materials used for making the matrixes serving for DNA molecule binding such as graphite, gold, platinum, carbon electrode, etc. (Cha et al., 2003; Wang and Zhou, 2002). This type of detection has several advantages such as: easy DNA immobilization (physical or electrochemical), decreased response time, higher stability and sensitivity, easy transporting of the device, etc.

DNA microarrays and next generation sequencing

Development of DNA microarrays initiated a new phase in the field of pathogen detection. DNA Microarray application provides sensitive and accurate analysis of transcriptome and DNA sequence variations (Yoo et al., 2004). Depending on the concept of the method Microarray techniques can be divided in those targeting the rRNA or DNA expression (cDNA microarrays) and those targeting DNA sequence variation (oligonucleotide microarrays) (Tillib and Mirzabekov, 2001). Wilson et al. (2002) have developed Multi Pathogen Identification (MPID) microarray that can be used for the identification of eighteen different pathogens. The assay is based on oligonucleotide detection and it has very high specificity. DNA Microarray technology (DNA chip) is a promising tool for pathogen detection and can find its application in various areas, among which also food microbiology, detecting either expression of virulence genes or specific diverse individual sequences of the DNA molecule (Yoo et al., 2004; Mandal et al., 2011).

Another revolutionary discovery in bioinformatics is next generation sequencing - Pyrosequencing. This is a powerful new technology which enables generation of over one million DNA sequences per run, parallel analysis of multiple samples, detection of unknown pathogens in complex samples and is yet to widen its application in food pathogen detection (Adams et al., 2009).

Instead of conclusion

Advances in the field of immunology, molecular biology, automatization and bioinformatics continue with their positive effects for the development of fast, sensitive and reliable methods for detection of pathogenic and spoilage food microorganisms. Molecular-biology, DNA or RNA based methods, especially PCR, can gradually replace conventional ones. There are still many problems waiting to be solved such are sample preparation, elimination of the effects caused by the unspecific binding and cross-hybridization and achieving biggest sensitivity of the methods. However, the potential of molecular-biology techniques is almost revolutionary.

Furthermore, biosensors are representing a new era in foodborne pathogen detection. It is believed that by their further development and advances in modern biotechnology, microbial biosensors will have promising and light future.

References

- Adams, I.P., Glover, R.H., Monger, W.A., Mumford, R., Jackeviciene, E., Navalinskiene, M., Samuitiene, M., Boonham, N. (2009): Next-generation sequencing and metagenomic analysis: a universal diagnostic tool in plant virology, *Molecular Plant Pathology* 4, 537-545.
- Barbour, W.M., Tice, G. (1997): Genetic and immunologic techniques for detecting foodborne pathogens and toxins. In: Doyle, M.P., Beuchat, L.R., Montville, T.J. (Eds.), *FoodMicrobiology, Fundamentals and Frontiers*, ASM Press, Washington DC, pp. 710–727.
- Bej, A.K., Mahbubani, M.H., Boyce, M.J., Atlas, R.M. (1994): Detection of *Salmonella* spp. in oysters by PCR, *Appl. Environ. Microbiol.* 60, 368-373.
- Bruce, J. (1996): Automated system rapidly identifies and characterizes microorganisms in food, *Food technology* 50, 77-81.
- Cha, J., Han, J.I., Choi, Y., Yoon, D.S., Who, K., Lim, G. (2003): DNA hybridization electrochemical sensor using conducting polymer, *Biosensors and Bioelectronics* 18, 1241–1247, 2003.
- Chan, A.B., Fox, J.D. (1999): NASBA and other transcription-based amplification methods for research and diagnostic microbiology, *Rev. in Med. Microbiol.* 10, 185-196.
- Chen, J. (2003): Contemporary monitoring methods. In: R.H. Schmidt and G.E. Rodrick (Eds.), *Food safety handbook* (chapter 11). Hoboken, NJ: John Wiley and Sons, Inc.

- Chamberlain, J.S., Gibbs, R.A., Ranier, J.E., Nguyen, P.N., Caskey, C.T. (1988): Deletion screening of the Duchenne muscular dystrophy locus via multiplex DNA amplification, *Nucleic Acids Res.* 16, 11141–11156.
- Compton, J. (1991): Nucleic acid sequence-based amplification, *Nature* 350, 91-92.
- Cone, R.W., Hobson, A.C., Huang, M.L. (1992): Coamplified positive control detects inhibition of polymerase chain reactions, *J. Clin. Microbiol.* 30, 3185-3189.
- Davis, F., Nabok, A.V., Higson, S.P.J. (2005): Species differentiation by DNA-modified carbon electrodes using an ac impedimetric approach, *Biosensors and Bioelectronics* 20, 1531-1538.
- de Boer, Enne, Beumer, R.R. (1999): Methodology for detection and typing of foodborne microorganisms, *International Journal of Food Microbiology* 50, 119–130.
- Deiman, B., van Aarle, P., Sillekens, P. (2002): Characteristics and applications of nucleic acid sequence-based amplification (NASBA), *Mol. Biotechnol.* 20, 163-179.
- Edwards, K., Logan, J., Saunders, N. (2004): *Real-time PCR: an Essential Guide*. Norfolk, UK: Horizon Bioscience.
- Fung, D.Y.C. (2002): Predictions for rapid methods and automation in food microbiology, *J. AOAC Int.* 85, 1000-1002.
- Heid, C.A., Stevens, J., Livak, K.J. Williams, P.M., (1996): Real time quantitative PCR, *Genome Res.* 6, 986-994.
- Higuchi, R., Fockler, C., Dollinger, G., Watson, R. (1993): Kinetic PCR: Real time monitoring of DNA amplification reactions, *Biotechnology* 11, 1026–1030.
- Hoorfar, J., Malorny, B., Abdulmawjood, A., Cook, N., Wagner, M., Fach, P. (2004): Practical considerations in design of internal amplification control for diagnostic PCR assays, *J. Clin. Microbiol.* 42, 1863-1868.
- Kavita, A., Subhash C., Malhotra, B.D. (2006): Recent developments in bio-molecular electronics techniques for food pathogens, *Analytica Chimica Acta* 568, 259–274.
- Käferstein, F.K., Motarjemi, Y., Bettcher, D.W. (1997): Foodborne disease control: a transnational challenge, *Emerging Infect. Dis.* 3, 503-510.
- Knowk, S., Higuchi, R. (1989): Avoiding false positivies with PCR, *Nature* 339, 237-238.
- Lazcka, O., Del Campo, F. J., Muñoz, X. (2007): Pathogen detection: A perspective of traditional methods and biosensors – a review, *Biosensors and bioelectronics* 22, 1205-1217.
- Lu, H., Zhao, Y., Ma, J., Li, W., Lu, Z. (2000): Coll. Surf. A: Physicochem, *Eng. Aspects* 175, 147.
- Mandal, P.K., Biswas, A.K., Choi, K., Pal, U.K. (2011): Methods for rapid detection of foodborne pathogens: an overview, *American Journal of Food Technology* 6, 87-102.
- Mandrell, R., Wachtel, M.R. (1999): Novel detection techniques for human pathogens that contaminate poultry, *Current Opinion Biotech.* 10 (3), 273-278.
- McPherson, M.J., Møller, S.G. (2000): Reagents and instrumentation: PCR: BIOS Scientific Publishers Ltd, Oxford, pp. 23–60.
- Mengaud, J., Vicente, M.F., Chenevert, J., Pereira, J.M., Geoffroy, C., Gicquel-Sanzey, B., Baquero, F., Perez-Diaz, J.C., Cossart, P. (1988): Expression in *Echerichia coli* and sequence analysis of listeriolysin O determinant of *Listeria monocytogenes*, *Infection and Immunity* 56, 4, 766-772.

- Mead, P.S., Slutsker, L., Griffin, P.M., Tauxe, R.V. (1999): Food-related illness and death in the United States, *Emerging Infect. Dis.* 5, 607-625.
- Normand, P., Ponsonnet, C., Nesme, X., Neyra, M., Simonet, P. (1996): ITS analysis of prokaryotes: Molecular Microbial Ecology Manual: Kluwer Academic Publishers, Dordrecht, pp. 1–12.
- Oyofe, B.A., Thornton, S.A., Burr, D.H., Trust, T.J., Pavlovskis, O.R., Guerry, P. (1992): Specific detection of *Campylobacter jejuni* and *Campylobacter coli* by using polymerase chain reaction, *Journal of Clinical Microbiology* 30, 2613-2619.
- Paton, A.W. Paton, J.C. (1998): Detection and characterization of shiga toxinogenic *E. coli* by using multiplex PCR assays for stx1, stx2, eaeA, enterohemorrhagic *E. coli* hlyA, rfbO11 and rfbO157, *Journal of Clinical Microbiology* 36, 598-602.
- Pimbley, D.W., Patel, P.D. (1998): A review of analytical methods for the detection of bacterial toxins, *J. Appl. Microbiol. Symp. Suppl.* 84, 98S–109S.
- Powledge, T.M. (2004): The polymerase chain reaction, *Advan Physiol Educ* 28, 44-50.
- Rasmussen, H.N., Rasmussen, O.F., Andersen, J.K., Olsen, J.E. (1994): Specific detection of *Yersinia enterocolitica* by two step PCR using hot-start and DMSO, *Molecular and cellular probes* 8, 99-108.
- Rodríguez-Lázaro, D., Hernández, M. (2006): Molecular methodology in food microbiology diagnostics: trends and current challenges, IUFoST 2006 DOI: 10.1051/IUFoST:20060643. Article available at <http://iufost.edpsciences.org> or <http://dx.doi.org/10.1051/IUFoST:20060643>
- Rosselló-Mora, R., Amann, R. (2001): The species concept for prokaryotes, *FEMS Microbiol. Rev.* 25, 39–67.
- Rådström, P., Knutsson, R., Wolfs P., Dahlenborg Lofström, C. (2003): Pre-PCR processing of sampling. In: Sachse, K. and Frey, J. (Eds.) *Methods in Molecular Biology: PCR detection of microbial pathogens*. Humana Press, Totowa, USA, pp. 31-50.
- Rossen, L., Norskov, P., Holmstorm, K., Rasmussen, O.F. (1992): Inhibition of PCR by components of food samples, microbial diagnostic assays and DNA-extraction solutions, *Int. J. Food Microbiol.* 17, 37-45.
- Scheu, P.M., Berghof, K. Stahl, U. (1998): Detection of pathogenic and spoilage microorganisms in food with the polymerase chain reaction, *Food Microbiol.* 15, 13-31.
- Schmittgen, T.D., Zakrajsek, B.A., Mills, A.G., Gorn, V., Singer, M.J. Reed, M.W. (2000): Quantitative reverse transcription-polymerase chain reaction to study mRNA decay: comparison of endpoint and real-time methods, *Anal. Biochem.* 285, 194-204.
- Swaminathan, B., Feng, P. (1994): Rapid detection of food-borne pathogenic bacteria, *Annu. Rev. Microbiol.* 48, 401–426.
- Tillib, S.V., Mirzabekov, A.D. (2001): Advances in the analysis of DNA sequence variations using oligonucleotide microchip technology, *Curr. Opin. Biotechnol.* 12, 53-58.
- Torriani, S., Felis, G.E., Dellaglio, F. (2001): Differentiation of *Lactobacillus plantarum*, *L. pentosus*, and *L. paraplantarum* by recA gene sequence analysis and multiplex PCR assay with recA gene-derived primers, *Appl. Environ. Microbiol.* 67, 3450–3454.

Plenary lectures

- Tsen, H.Y., Liou, W., Lin, C.K. (1994): Possible use of polymerase chain reaction method for the specific Salmonella in beef, *Journal of fermentation and Bioengineering* 77, 137-143.
- Valasek, M.A., Repa, J. (2005): The power of real-time PCR, *Advan Physiol Educ* 29, 151-159.
- van Belkum, A., Struelens, M., de Visser, A., Verbrugh, H., Tibayrenc, M. (2001): Role of Genomic Typing in Taxonomy, Evolutionary Genetics, and Microbial Epidemiology, *Clinical Microbiology Reviews* 14 (3), 547-560.
- Vos, P., Hogers, R., Bleeker, M., Rijans, M., van de Lee, T., Hornes, M., Frijters, A., Pot, J., Peleman, J., Kuiper, M., Zabeau, M. (1995): AFLP: a new technique for DNA fingerprinting, *Nucleic Acid Res.* 23, 4407-4414.
- Wang, J., Zhou, F. (2002): Scanning Electrochemical Microscopic Imaging of Surface-Confined DNA Probes and Their Hybridization via Guanine Oxidation, *J. Electroanal. Chem.* 537, 95-102.
- Wallace, .D.J., Van Gilder, T., Shallow, S., Fiorentino, T., Segler, S.D., Smith, K.E., Shiferaw, B., Etzel, R., Garthright, W.E., Angulo, F.J. (2000): Incidence of Foodborne Illnesses Reported by the Foodborne Diseases Active Surveillance Network (FoodNet)-1997, *J. Food Prot.* 63, 807-809.
- Wilson, I.G. (1997): Inhibition and facilitation of nucleic acid amplification, *Appl. Environ. Microbiol.* 63, 3741-3751.
- Willson, W.J.C., Strout, T.Z., Desantis, J. L., Stilwell, A., Carrano, V., Andersen, G.L. (2002): Sequence-specific identification of 18 pathogenic microorganisms using microarray technology, *Mol. Cell Probe* 16, 11-127.
- Wiedmann, M. (2002): Molecular subtyping methods for *Listeria monocytogenes*, *J. AOAC Int.* 85, 524-531.
- Yoo, S.M., Keum, K. C., Yoo, S.Y., Choi, J.Y., Changa, K.H., Yoo, N.C., Yoo, W.M., Kim, J.M., Lee, D., Lee, S.Y. (2004): Development of DNA Microarray for Pathogen Detection, *Biotechnology and Bioprocess Engineering* 9, 93-99.

Heterociklički kondenzirani kinoloni i kinolini kao potencijalni antitumorski agensi

UDC: 547.831 : 616-006

G. Karminski-Zamola*

Zavod za organsku kemiju, Fakultet kemijskog inženjerstva i tehnologije Sveučilišta u Zagrebu, Marulićev trg 20, 10000 Zagreb

Summary

A lot of condensed benzothienoquinolones, benzothienonaphthyridones and thienothierylquinolones, as well as, benzimidazo[1,2-a]quinolines and their heterocyclic analogues diazacyclopenta[c]fluorenes were prepared in multistep synthesis. The pharmacophore groups were introduced in the main structure. Among the lot of prepared compounds the best antitumor activities „in vitro“ on a few human tumor cell lines showed the compounds as follows:

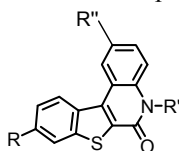

- 1 R = OCH₃; R' = (CH₂)₃N(CH₃)₂ R'' = H
2 R = COOCH₃; R' = (CH₂)₃N(CH₃)₂, R'' = H
3 R = CONHPh, R' = (CH₂)₃N(CH₃)₂, R'' = H
4 R = CONH(CH₂)₃N(CH₃)₂, R' = H, R'' = H
5 R = H; R' = H, R'' = iso-pr-amidin,
6 R = CH₃; R' = H, R'' = iso-pr-amidin,
7 R = COOCH₃; R' = H, R'' = iso-pr-amidin,
8 R = iso-pr-amidin; R' = H, R'' = COOCH₃,
9 R = iso-pr-amidin; R' = H, R'' = Br

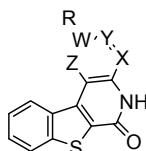

- 10 X=Y=Z= CH; R= H; W= NH⁺Cl⁻
11 X= N; Y=Z= CH; R= CN; W= C
12 X=Z= CH; Y= N; W= C;
13 X=Y= CH; Z= N; W= C;
14 X= N; Y=Z= CH; W= C;

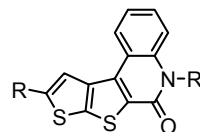

- 15 R= H; R' = (CH₂)₃N(CH₃)₂
16 R= COOCH₃; R' = (CH₂)₃N(CH₃)₂
17 R= CONH(CH₂)₃N(CH₃)₂, R' = H

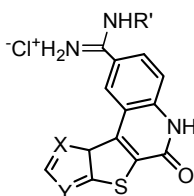

- 18 X=C, Y=S, R' = H
19 X=C, Y=S, R' = CH(CH₃)₂
20 X=S, Y=C, R' = H
21 X=S, Y=C, R' = CH(CH₃)₂

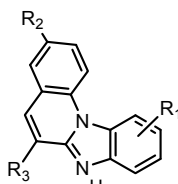

- 22 R₁=CH₂, R₂=H, R₃=H
23 R₁=CN, R₂=H, R₃=H

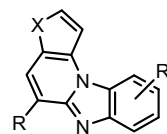

- 24 R=H, X=S, R' = N-CH₃
25 R=CN, X= N-CH₃ R'=H

The change of the terminal benzene nuclei of the acidic part of the molecule with thiophene in quinolones didn't significantly influenced on the antitumor activity, while the substitution of the quinolone nuclei with the naphthyridone nuclei increased antitumor activity. Quinolones and quinolines showed very similar and good antitumor activity. DNA binding reactions were detected by changes in fluorescence, UV and CD spectra.

*gzamola@fkit.hr

Uvod

Kondenzirani kinoloni i kondenzirani kinolini kao t.zv male aromatske i heteroaromske molekule poznate su po svojem biološkom djelovanju i intenzivno se proučavaju zadnjih nekoliko godina na biološko djelovanje i to naročito na antitumorsko djelovanje gdje je cilj njihova djelovanja prvenstveno DNA i/ili odgovarajući enzimi¹⁻²⁴.

Kao što se može vidjeti iz predloženih struktura, kinoloni i izokinoloni u svojoj strukturi sadrže laktamski prsten što odgovara i beta kinolonima:

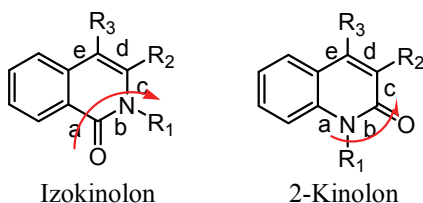

Prirodni 2-kinoloni, koji pokazuju biološku aktivnost nisu brojni a poznati su na pr²³:

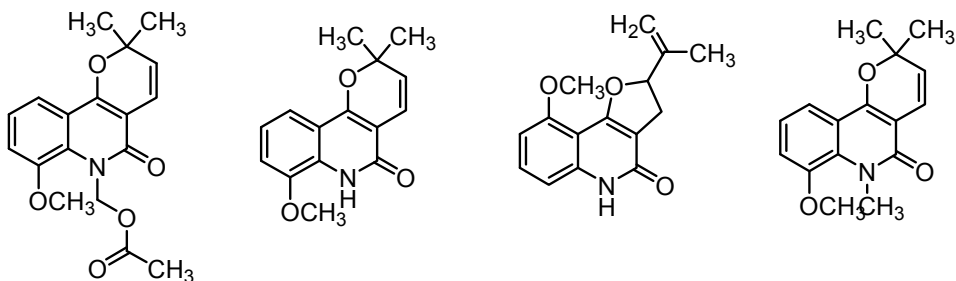

Zanthophylline, 8-Methoxyflindersine, 5-Methoxyalmene, 8-Methoxy-N
methyl-flindersine

U kinolinskom redu također ima niz spojeva, koji pokazuju izrazito biološko djelovanje a naročito antitumorsko. Samo da spomenem neke najnovije radove²²⁻²⁴. Iz predloženih kinolinskih struktura može se vidjeti da su biološki aktivni kinolini kondenzirani s aromatskim i heteroaromatskim jezgrama. Takve kinolinske strukture pokazuju najčešće antitumorsko djelovanje, ali služe i kao cijaninske boje.

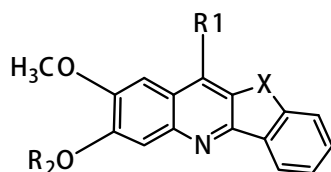

X=CH₂, CH₂CH₂, O, CO
R₁=H, CH₃, R₂=alkil, dialkilaminopropil

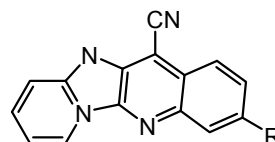

R=H, Cl, Br, OMe, Me

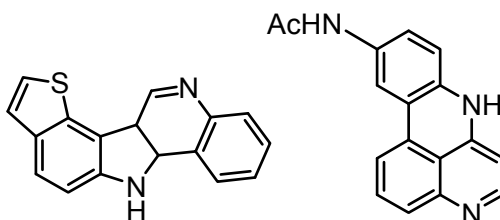

U prirodi su izolirani kinolini iz alkaloida, međutim nisu poznati kinolini sa više kondenziranih aromatskih ili heterocikličkih jezgara.

Vlastita istraživanja

Priprava heterocikličkih kondenziranih kinolona i biskinolona

Interes za proučavanjem fotokemijskih dehidrocklizacija i dehidrohalogeniranja u svrhu dobivanja odgovarajućih kondenziranih aromatskih i heteroaromatskih kinolona i bis kinolona, započeo je u našoj istraživačkoj grupi 1986 god i nastavio se čitav niz godina²⁵⁻³⁰.

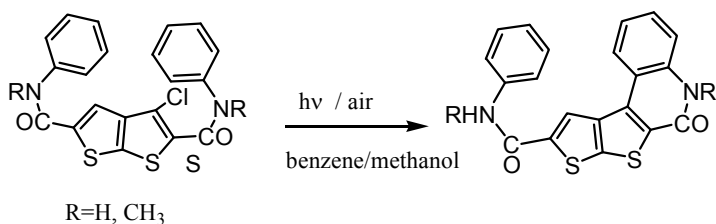
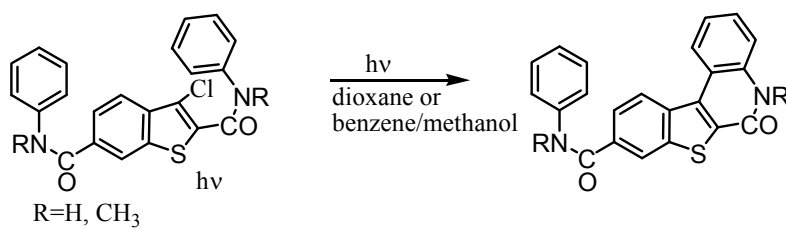
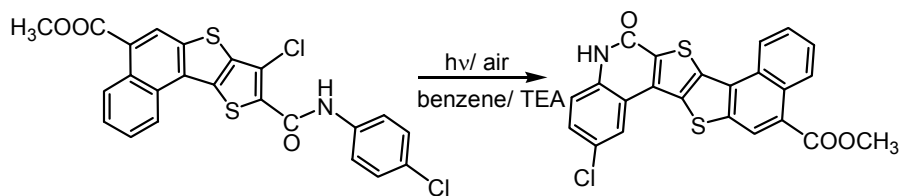
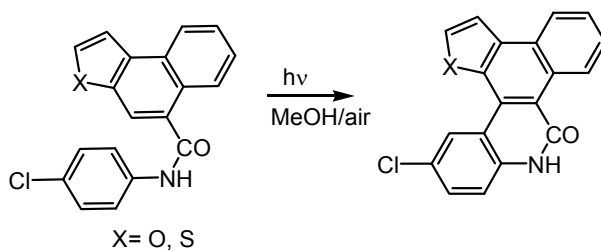
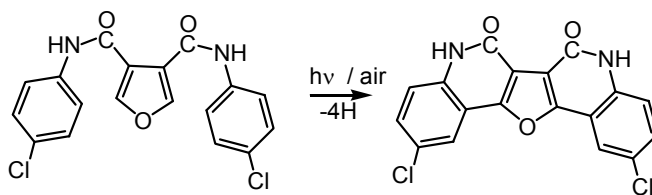

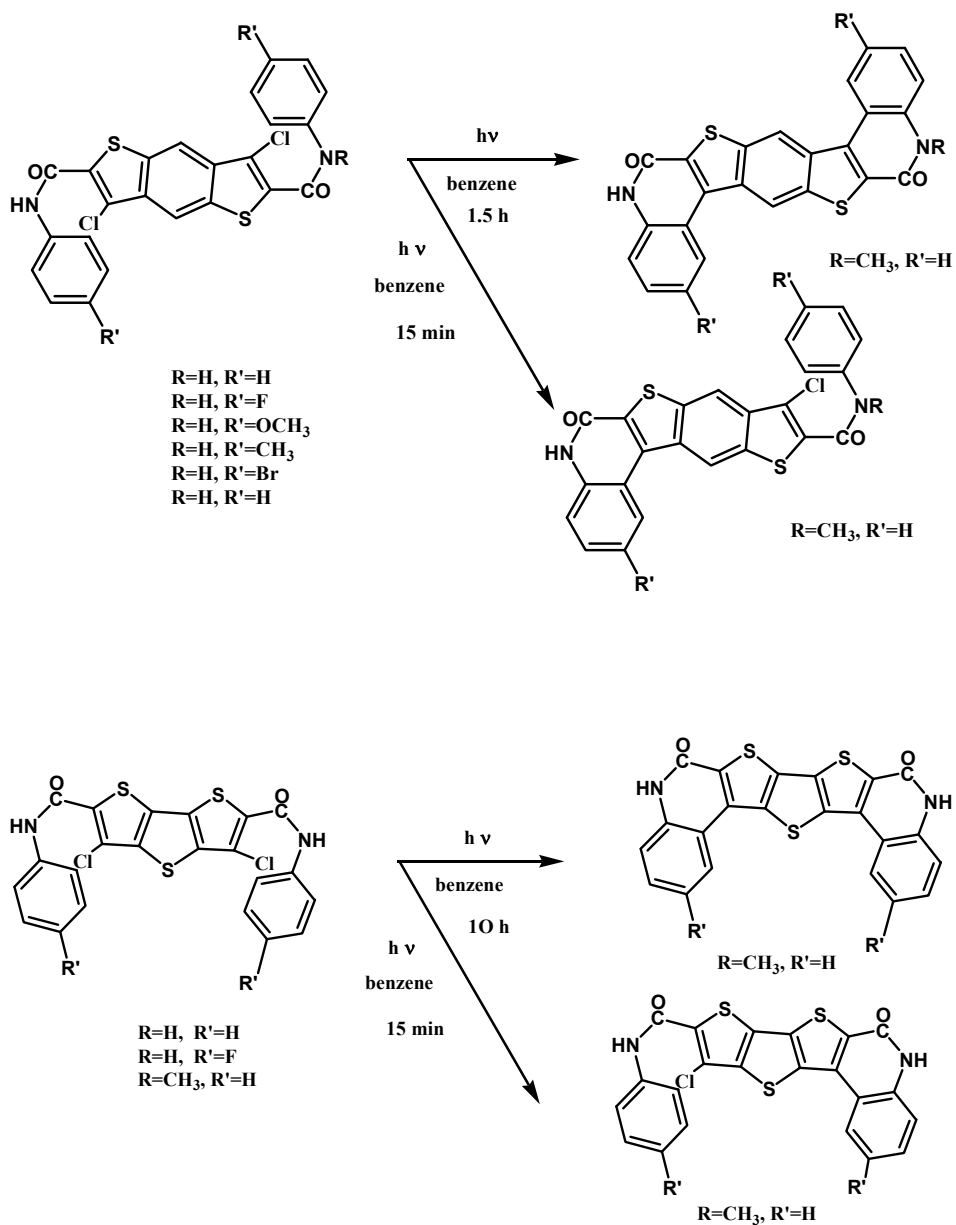

Slika 1.

Sinteza i antitumorsko djelovanje „in vitro“ heterocikličkih kondenziranih kinolona

Iskustva stečena na višestupnjevitoj sintezi, koja u zadnjoj fazi uključuje fotokemijsku ciklizaciju u odgovarajuće kondenzirane kinolone i bis-kinolone benzo-tiofenskog i tienotiofenskog reda, motivirala nas je da u odgovarajuće molekule, koje su mahom bile planarne strukture, uvedemo odgovarajuće farmakoforne supstituente, koji se na uvedenom dušikovom atomu farmakoforne grupe mogu protonirati i tako prevesti u odgovarajuću sol kao topiviji oblik pogodan za antitumorska ispitivanja. Tako je nastala serija dimetilaminopropil-supstiuiranih benzo-tiofen i tieno-tiofen kondenziranih kinolona slijedeće strukture.

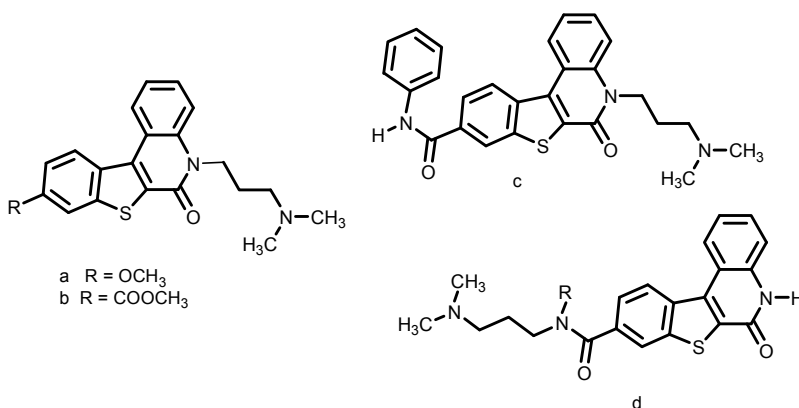

Slika 2.

Najbolje antitumorsko djelovanje pokazale su supstancije a, b i c. C je bio aktivan u koncentraciji od $> 0,01$ mikromolova na stanice melanoma „in vitro“ (Slika 2)³¹

Uvođenjem novih farmakofornih grupa kako cijano i/ili amidinskih i supstituiranih amidinskih grupa u prekursor-odgovarajuće amide, na različita mjesta u benzo-tiofen-kinolonskoj jezgri, dobili smo niz spojeva sa intenzivnim biološkim djelovanjem ali ne bitno različitim od prethodnih: primjeri spojeva sa najintenzivnijim djelovanjem su slijedeći:

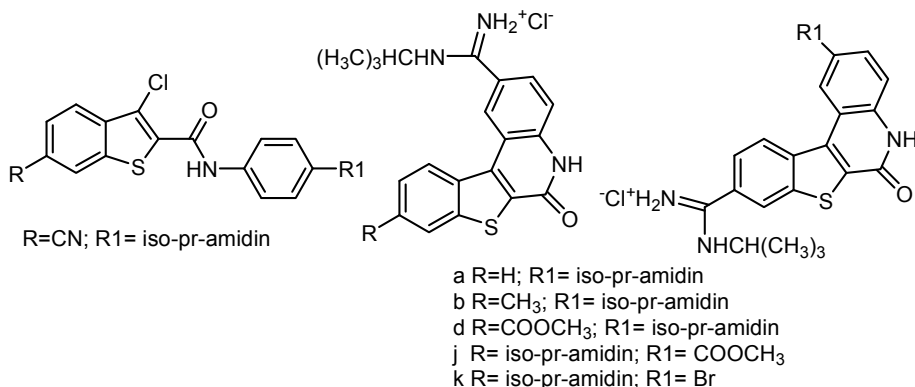

Slika 3.

Spojevi označeni pod d, j, k da li su dobre biološke rezultate na antitumorsko djelovanje i pretpostavlja se da djeluju kao otrovi na topoizomerazu te kao i interkalatori.³²

Slijedeću seriju predstavljao je niz priređenih tieno-tienilkarboksanilida kao prekursora za fotokemijsko dobivanje odgovarajućih tienotienil-kinolona. Benzenska jezgra zamijenjena je tiofenskom na kiselinskoj strani molekule a farmakofor je dimetilaminopropilni lanac supstituiran bilo na laktamskom dišikovom atomu, bilo na terminlnoj tiofenskoj jezgri³³

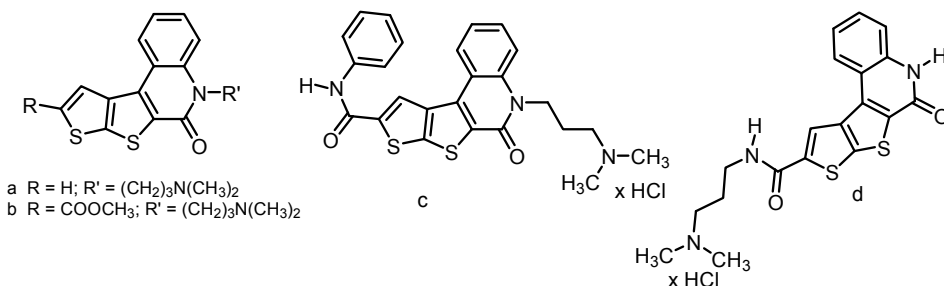

Slika 4.

Antitumorska aktivnost u odnosu na benzotiofensku jezgru nije se znatno promijenila osim kod spoja d, t.j. kod spoja sa dimetilamino-propilamidnom grupom u položaju 5, koji je pokazao znatnu aktivnost u koncentraciji od 0.1

mikromolova na stanice raka pankreasa., dok amidino-supstiuirani kinoloni nisu pokazali bolju aktivnost u odnosu na benzotiofenske analoge³⁴

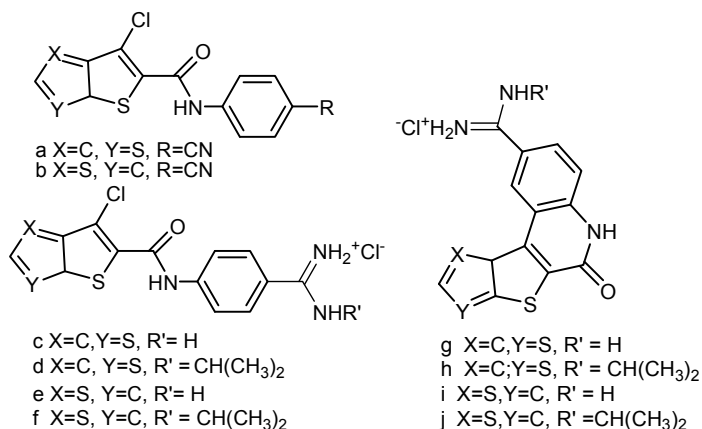

Slika 5.

Međutim su amidni prekursori tj. cijano supstituirani anilidi pokazali izrazitu aktivnost na stanice raka grla maternice i cerviksa³⁴

Kada je benzenska jezgra na aminskoj strani molekule zamijenjena s piridinskom jezgrom i uvedena nova imidazolinska grupa u piridinsku jezgru, antitumorska aktivnost je znatno porasla naročito u cikličkim spojevima c, d, i e.³⁵

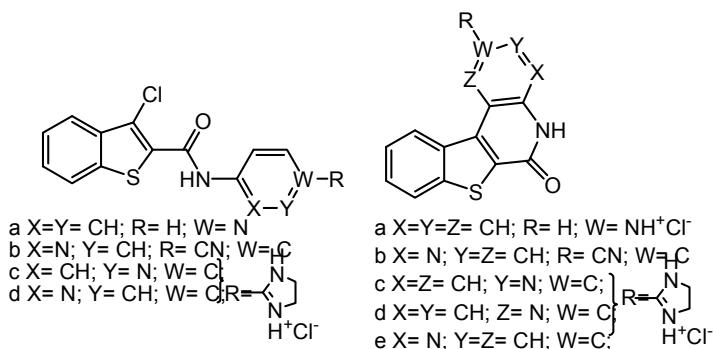

Slika 6.

Sinteza heterocikličkih kondenziranih kinolina i njihovo antitumorsko djelovanje

Osim kinolona i kondenzirani kinolini pokazuju vrlo intenzivno antitumorsko djelovanje.

Kinoloni koje smo mi priređivali predstavljaju izostere priređenih kinolona. Spadaju u grupu benzimidazo[1,2-a] kinolina i njihovih heterocikličkih analoga; diazacaklopenta[c]fluorena. To su uglavnom planarne molekule slijedeće strukture:

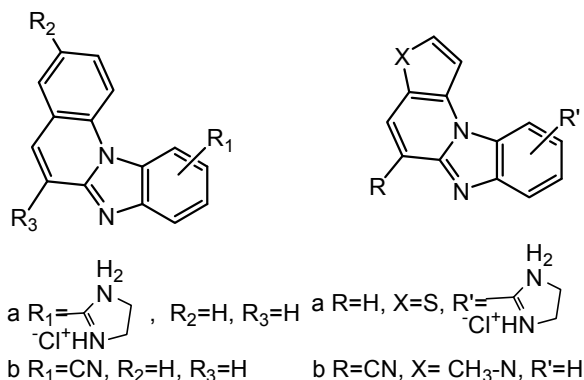

Slika 7.

Između niza priređenih amidina, supstituiranih amidina, spoj a može djelovati kao interkalator ali ujedno i inhibitor topoizomeraze II, dok cijano supstituirani spoj b pokazuje izrazitu selektivnost i učinkovitost na tumor stanica pankreasa. Kada se u položaj 6 benzimidazo[1,2-a] kinolina uvede cijano grupa, ($R_3 = \text{CN}$) pokazalo se da bitno ne utječe na antitumorsku aktivnost.

U diazacaklopenta[c]fluorenskom redu između niza priređenih amidina, imidazolin-supstituirani spoj pokazuje daleko najjaču antitumorsku aktivnost, ali ne i selektivnost.

Uvođenjem terminalne tiofenske jezgre u osnovnu strukturu nije se bitno promijenila antitumorska aktivnost međutim uvođenjem N-metil-pirolne jezgre te cijano grupe u položaj 5 osnovne strukture, antitumorska aktivnost je naročito izražena i to najviše na stanice raka pankreasa.

Iz navedenih studija može se zaključiti da su svi priređeni spojevi ove grupe antitumorski aktivni, a kombinacijom odgovarajućih supstituenata može se postići bolja antitumorska aktivnost „in vitro“.

Kao grupe koje su osim same jezgre, odgovorne za antitumorsku aktivnost su cijano i protonirana imidazolinska grupa, a kod ciklopenta[c]fluorena, aktivnost pridonosi n-metilirana pirolska jezgra. Biblioteka priređenih spojeva omogućit

će SAR (Structure Activity Relationship) analizu, koja će predvidjeti nove efikasnije strukture.³⁶⁻³⁹

Interakcija kondenziranih kinolona i kondenziranih kinolina s ct-DNA

Priredene molekule ispitane su na njihovo djelovanje na odsječak ct-DNA i kod većine spojeva zaključeno je da se ponašaju kao interkalatori; kao planarne strukture ugrađuju se između parova baza i sa svojim kationskim supstituentima vezuju dva lanca nukleotida i na taj način sprječavaju rasplitanje odnosno replikaciju DNA a s time i stvaranje novih stanica.

Nastajanje kompleksa spoj-DNA određuje se gašenjem fluorescentne emisije primijenjenih pojeva odnosno smanjenjem ekstinkcije u UV spektru što se može vidjeti iz priloženih krivulja. Također cirkularni dikroizam daje podatke o konformacijskim promjenama DNA uzrokovanih djelovanjem malih molekula.

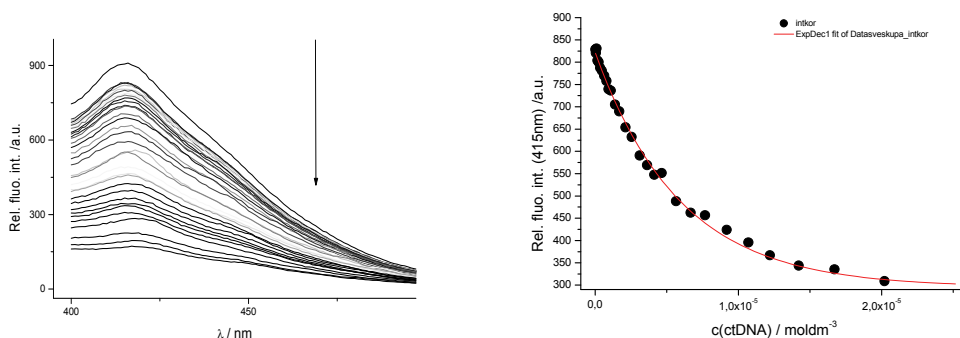

Slika 8. Promjene u fluorescentnom spektru kondenziranog kinolona 19³⁶ te ovisnost intenziteta fluorescencije istog spoja kod $\lambda = 415$ nm o koncentraciji ct-DNA

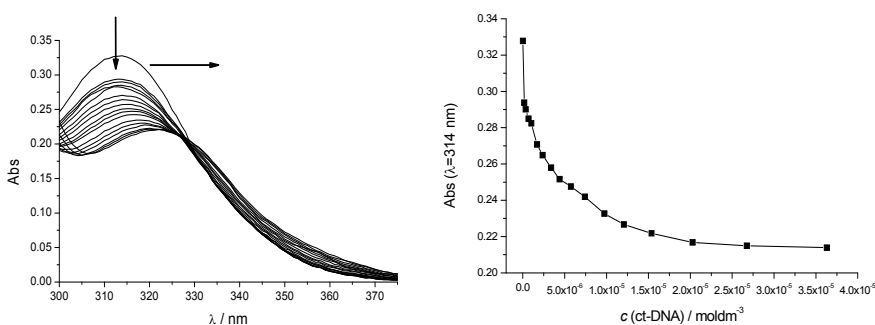

Slika 9. UV/vis titracija kondenziranog kinolina s ct-DNA i spektroskopske promjene kod $\lambda_{\max} = 314$ nm kao funkciju koncentracije ct-DNA

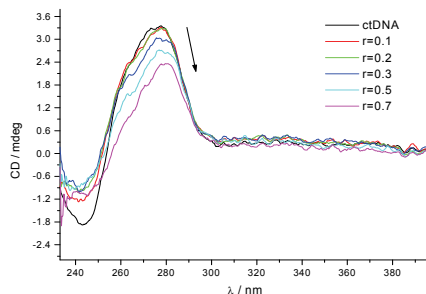

Slika 10. CD titracija ct-DNA sa kinolinom

Zaključak

Iz niza priređenih kondenziranih kinolona i kinolina može se zaključiti slijedeće:

- benzotienokinoloni pokazuju izrazitu antitumorsku aktivnost na ispitane stanice humanog karcinoma kada su u osnovnu jezgru uvedene farmakoforne grupe i to N-dimetilamino grupa amidio ili supstituirana amidino grupa u više različitih položaja.
- kada je terminalna benzenska jezgra zamijenjena tiofenskom i uvedeni gore navedeni farmakofori antitumorska aktivnost nije se bitno promijenila.
- kada je benzenska jezgra s aminske strane zamijenjena 2- ili 3-piridinskom i u piridinsku jezgru uveden imidazolinski supstituent, antitumorska aktivnost je znatno porasla. Dakle ta kombinacija jezgre i farmakofora se čini najuspješnijom kombinacijom.
- kod kondenziranih kinolina situacija je vrlo slična. Imidazolinski supstituent u benzimidazo[1,2-a]kinolinima pokazao je vrlo dobru antitumorsku aktivnost, dok kod diazaciklopenta-fluorena s terminalnom tiofenskom jezgrom u kombinaciji s imidazolinskim farmakoforom antitumorska aktivnost je bila znatna.
- kod 6-cijano supstituiranih fluorena, gdje je terminalna grupa bila N-metil-pirolna antitumorska aktivnost je porasla.

Literatura:

1. Diana, P., Martorana, A., Barraja, P., Montalbano, A., Dattolo, G., Cirrincione, G., Dall'Acqua, F., Salvador, A., Vedaldi, D., Basso, G., Viola, G. (2008): Isoindolo[2,1-*a*]quinoxaline derivatives, novel potent antitumor agents with dual inhibition of tubulin polymerization and topoisomerase I, *J. Med. Chem.* 51 (8), 2387-2399.
2. Wilson, L., Jordan, M.A. (1995): Microtubule dynamics: taking aim at a moving target, *Chem. Biol.* 2 (9), 569-573.
3. Magedov, I. V., Manpadi, M., Ogasawara, M. A., Dhawan A. S., Rogelj, S., Van Slambrouck, S., Steelant, W. F., Evdokimov, N. M., Uglinskii, P. Y., Elias, E. M., Knee, E. J., Tongwa, P., Antipin, M. Y., Kornienko, A. (2008): Structural Simplification of Bioactive Natural Products with Multicomponent Synthesis. 2. Antiproliferative and Antitubulin Activities of Pyrano[3,2-*c*]pyridones and Pyrano[3,2-*c*]quinolones, *J. Med. Chem.* 51 (8), 2561-2570.
4. Letafat, B., Emami, S., Mohammadhosseini, N., Faramarzi, M. A., Samadi, N., Shafiee, A., Foroumadi, A. (2007): Synthesis and antibacterial activity of new N-[2-(thiophen-3-yl)ethyl]piperazinyl quinolones, *Chem. Pharm. Bull.* 55 (6), 894-898.
5. Wang, S.W., Pan, S.L., Huang, Y.C., Guh, J.H., Chiang, P.C., Huang, D.Y., Kuo, S.C., Lee, K.H., Teng, C.M. (2008): CHM-1, a novel synthetic quinolone with potent and selective antimetabolic antitumor activity against human hepatocellular carcinoma *in vitro* and *in vivo*, *Mol. Cancer. Ther.* 7 (2), 350-360.
6. Hoang, H., LaBarbera, D.V., Mohammed, K.A., Ireland, C.M., Skibo, E.B. (2007): Synthesis and Biological Evaluation of Imidazoquinoxalinones, Imidazole Analogues of Pyrroloiminoquinone Marine Natural Products, *J. Med. Chem.* 50 (19), 4561-4571.
7. Chen, M.H., Fitzgerald, P., Singh, S.B., O'Neill, E.A., Schwartz, C.D., Thompson, C.M., O'Keefe, S.J., Zaller, D.M., Doherty, J.B. (2008): Synthesis and biological activity of quinolinone and dihydroquinolinone p38 MAP kinase inhibitors, *Bioorg. Med. Chem.Lett.* 18 (6), 2222-2226.
8. Srivastava, S.K., Jha, A., Agarwal, S.K., Mukherjee, R., Burman, A.C. (2007): Synthesis and Structure-Activity Relationships of Potent Antitumor Active Quinoline and Naphthyridine Derivatives, *Anticancer Agents Med. Chem.* 7 (6), 685-709.
9. Deady, L.W., Rogers, M.L., Zhuang, L., Baguley, B.C., Denny, W.A. (2005): Synthesis and cytotoxic activity of carboxamide derivatives of benzo[*b*][1,6]naphthyridin-(5*H*)ones, *Bioorg. Med. Chem.* 13 (4), 1341-1355.
10. Swaminathan, R., Natarajan, P.L., Levorsea, M., Thompson, J.E., O'Neill, E.A., O'Keefe, S.J., Vorab, K.A., Cvetovitch, R., Chung, J. Y., Carballo-Jane, E., Visco, D.M. (2006): p38 MAP kinase inhibitors. Part 5: Discovery of an orally bioavailable and highly efficacious compound based on the 7-amino-naphthyridone scaffold, *Bioorg. Med. Chem.Lett.* 16 (20), 5468-5471.
11. Bilodeau, M.T., Balitza, A.E., Hoffman, J.M., Manley, P.J., Barnett, S.F., Defeo-Jones, D., Haskell, K., Jones, R.E., Leander, K., Robinson, R.G., Smith, A.M., Huber, H.E., Hartman G.D. (2008): Allosteric inhibitors of Akt1 and Akt2: A naphthyridinone with efficacy in an A2780 tumor xenograft model, *Bioorg. Med. Chem. Lett.* 18 (11), 3178-3182.
12. Baraldi, P.G., Bovero, A., Fruttarolo, F., Preti, D., Tabrizi, M.A., Pavani, M.G., Romagnoli, R. (2004): DNA minor groove binders as potential antitumor and antimicrobial agents, *Med. Res. Rev.* 74 (4), 475-528.

13. Demirayak, S., Abu Mohsen, M., Cagri Karaburun, A. (2002): Synthesis and anticancer and anti-HIV testing of some pyrazino[1,2-*a*]benzimidazole derivatives, *Eur. J. Med. Chem.* 37 (3), 255-260.
14. Martínez, V., Burgos, V., Alvarez-Builla, J., Fernández, G., Domingo, A., Garcia-Nieto, R., Gago, F., Manzanares, I., Cuevas, C., Vaquero, J. J. (2004): Benzo[*f*]azino[2,1-*a*]phthalazinium Cations: Novel DNA Intercalating Chromophores with Antiproliferative Activity, *J. Med. Chem.* 47 (5), 1136-1148.
15. Jayasekera M.M., Onheiber K., Keith J., Venkatesan H., Stocking A.E.M., Tang L., Miller J., Gomez L., Rhead B., Delcamp T., Huang S., Wolin R., Bobkova E.V., Shaw K.J. (2005): Identification of novel inhibitors of bacterial translation elongation factors, *Agents Ch.* 49 (1), 131-136.
16. Ates-Alagöz, Z., Yildiz, S., Buyukbingöl, E. (2007): Antimicrobial Activities of Some Tetrahydronaphthalene-Benzimidazole Derivatives, *Chemother.* 53 (2), 110-113.
17. Göker, H., Özden, S., Yildiz, S., Boykin, D. W. (2005): Synthesis and potent antibacterial activity against MRSA of some novel 1,2-disubstituted-1*H*-benzimidazole-*N*-alkylated-5-carboxamidines, *Eur. J. Med. Chem.* 40 (10), 1062-1069.
18. Göker, H., Kus, C., Boykin, D.W., Yildiz, S., Altanlar, N. (2002): Synthesis of some new 2-substituted-phenyl-1*H*-benzimidazole-5-carbonitriles and their potent activity against *candida* species, *Bioorg. Med. Chem.* 10 (8), 2589-2596.
19. Morningstar, M.L., Roth, T., Farnsworth, D.W., Smith, M.K., Watson, K., Buckheit, R.W. Jr., Das, K., Zhang, W., Arnold, E., Julias, J.G., Hughes, S.H., Michejda, C.J. (2007): Synthesis, Biological Activity, and Crystal Structure of Potent Nonnucleoside Inhibitors of HIV-1 Reverse Transcriptase That Retain Activity against Mutant Forms of the Enzyme, *J. Med. Chem.* 50 (17), 4003-4015.
20. Brana, M.F., Castellano, J.M., Keilhauer, G., Machuca, A., Martín, Y., Redondo, C., Schlick, E., Walker, N. (1994): Benzimidazo [1,2-*c*] quinazolines: a new class of antitumor compounds, *Anti-Cancer Drug Des.* 9, 527-538.
21. Santana, L.L.B., Cardoso, L.A., Druzian, J.I., Souza, V.F., Costa, T.A.C., Nobrega, D.A., Hohlemwerger, S.V.A., Velozo, E.S. (2006): selectivity in the extraction of 2-quinolone alkaloids with supercritical CO₂, *Braz. Journal. Chem. Eng.* 23 (4), 525-530.
22. Malecki, N., Carato, P., Rigo, B., Goossens, J.F., Houssin, R., Bailly, C., Hénichar, J.P. (2004): Synthesis of condensed quinolines and quinazolines as DNA ligands, *Bioorg. Med. Chem.* 12 (3), 641-647.
23. Rahimizadeh, M., Pordel, M., Bakavoli, M., Eshghi, H. (2010): The synthesis of highly fluorescent heterocyclic compounds: Pyrido[22,12:2,3]imidazo[4,5-*b*]quinoline-12-yl cyanides, *Dyes and Pigments* 86 (3), 266-270.
24. Beauchard, A., Jaunet A., Murillo L., Baldeyrou B., Lansiaux A., Chérouvrier J-R., Domon L., Picot L., Bailly C., Besson T., Thiéry V. (2009): Synthesis and antitumoral activity of novel thiazolobenzotriazole, thiazoloindolo[3,2-*c*]quinoline and quinolinoquinoline derivatives, *Eur. J. Med. Chem.* 44 (10), 3858-3865.
25. Fišer-Jaki, L., Karminski-Zamola, G. (1986): Synthesis and Photochemical Behaviour of Substituted 3, 4-furandicarboxanilides, *Croat. Chem. Acta.* 59 (4), 891-984.
26. Karminski-Zamola, G., Bajić, M. (1989): Synthesis of benzofuro- and benzothienophenantridones by twofold photochemical dehydrocyclization reaction, *Synth. Comm.* 19 (7-8), 1325-1333.

27. Karminski-Zamola, G., Pavličić, D., Bajić, M., Blažević, N. (1991): The Synthesis of new Heteropolycyclic Quinolone by Twofold Photocyclization - Methoxycarbonylnaphtho [2", 1"-2', 3'-B]-thieno[4', 5'-2, 3]thieno[5, 4-C] quinolin-6(5H)- one, *Heterocycles*, 32 (12), 2323-2327.
28. Dogan, J., Karminski-Zamola, G., Boykin, D.W. (1995): Photosynthesis of some new heteropolycyclic quinolones, *Heterocycles*. 41 (8), 1659-1667.
29. Malešević, M., Karminski-Zamola, G., Bajić, M., Boykin, D.W. (1995): Photosynthesis of heteropolycyclic diquinolones twofold photodehydrohalogenation reaction of benzo[1, 2-b:4, 5-b']dithiophene- and dithieno[3, 2-b:2', 3'-d] thiophenedicarboxanilides, *Heterocycles* 41 (12), 2691-2699.
30. Dogan Koružnjak, J., Grdiša, M., Slade, N., Zamola, B., Pavelić, K., Karminski-Zamola, G. (2003): Novel Derivatives of Benzo[b]thieno[2,3-c]quinolones: Synthesis, Photochemical Synthesis, and Antitumor Evaluation, *J. Med. Chem.* 46 (21), 4516-4524.
31. Jarak, I., Kralj, M., Šuman, L., Pavlović, G., Dogan, J., Piantanida, I., Žinić, M., Pavelić, K., Karminski-Zamola, G. (2005): Novel Cyano- and *N*-Isopropylamidino-Substituted Derivatives of Benzo[b]thiophene-2-carboxanilides and Benzo[b]thieno[2,3-c]quinolones: Synthesis, Photochemical Synthesis, Crystal Structure Determination, and Antitumor Evaluation. 2, *J. Med. Chem.* 48 (7), 2346-2360.
32. Dogan Koružnjak, J., Slade, N., Zamola, B., Pavelić, K., Karminski-Zamola, G., (2002): Synthesis, photochemical synthesis and antitumor evaluation of novel derivatives of thieno (3', 2':4, 5)thieno(2, 3-c)quinolones, *Chem. and Pharm. Bull.* 50 (5), 656-660.
33. Jarak, I., Kralj, M., Piantanida, I., Šuman, L., Žinić, M., Pavelić, K., Karminski-Zamola, G. (2006): Novel cyano- and amidino-substituted derivatives of thieno[2,3-b]- and thieno[3,2-b]thiophene-2-carboxanilides and thieno[3',2':4,5]thieno- and thieno[2',3':4,5]thieno [2,3-c]quinolones: Synthesis, photochemical synthesis, DNA binding, and antitumor evaluation, *Bioorg. Med. Chem.* 14 (8), 2859-2868.
34. Ester, K., Hranjec, M., Piantanida, I., Čaleta, I., Jarak, I., Pavelić, K., Kralj, M., Karminski-Zamola, G. (2009): Novel Derivatives of Pyridylbenzo[b]thiophene-2-carboxamides and Benzo[b]thieno[2,3-c]naphthyridin-2-ones: Minor Structural Variations Provoke Major Differences of Antitumor Action Mechanisms, *J. Med. Chem.* 52 (8), 2482-2492.
35. Hranjec, M., Kralj, M., Piantanida, I., Sedić, M., Šuman, L., Pavelić, K., Karminski-Zamola, G. (2007): Novel Cyano- and Amidino-Substituted Derivatives of Styryl-2-Benzimidazoles and Benzimidazo[1,2-a]quinolines. Synthesis, Photochemical Synthesis, DNA Binding, and Antitumor Evaluation, Part 3, *J. Med. Chem.* 50 (23), 5696-5711.
36. Hranjec, M., Piantanida, I., Kralj, M., Šuman, L., Pavelić, K., Karminski-Zamola, G. (2008): Novel Amidino-Substituted Thienyl- and Furylvinylbenzimidazole: Derivatives and Their Photochemical Conversion into Corresponding Diazaacyclopenta[c]fluorenes. Synthesis, Interactions with DNA and RNA, and Antitumor Evaluation. 4, *J. Med. Chem.* 51 (16), 4899-4910.
37. Hranjec, M., Pavlović, G., Marjanović, M., Kralj, M., Karminski-Zamola, G. (2010): Benzimidazole derivatives related to 2,3-acrylonitriles, benzimidazo[1,2-a]quinolines and fluorenes: Synthesis, antitumor evaluation *in vitro* and crystal structure determination, *Eur. J. Med. Chem.* 45 (6), 2405-2417.

Heterocyclic condensed quinolones and quinolines as potential antitumor agents

G. Karminski-Zamola

Department of Organic Chemistry, Faculty of Chemical Engineering and Technology,
 University of Zagreb, Marulićev trg 20, 10000 Zagreb

Summary

A lot of condensed benzothienoquinolones, benzothienonaphthyridones and thienothienylquinolones, as well as benzimidazo[1,2-a]quinolines and their heterocyclic analogues diazacyclopenta[c]fluorenes were prepared in multistep synthesis: The pharmacophore groups were introduced in the main structure. Among the lot of prepared compounds the best antitumor activities „in vitro“ on a few human tumor cell lines showed the compounds as follows:

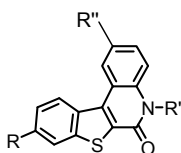

- 1 R = OCH₃; R' = (CH₂)₃N(CH₃)₂; R'' = H
 2 R = COOCH₃; R' = (CH₂)₃N(CH₃)₂; R'' = H
 3 R = CONHPh; R' = (CH₂)₃N(CH₃)₂; R'' = H
 4 R = CONH(CH₂)₃N(CH₃)₂; R' = H; R'' = H
 5 R = H; R' = H; R'' = iso-pr-amidin,
 6 R = CH₃; R' = H; R'' = iso-pr-amidin,
 7 R = COOCH₃; R' = H; R'' = iso-pr-amidin,
 8 R = iso-pr-amidin; R' = H; R'' = COOCH₃,
 9 R = iso-pr-amidin; R' = H; R'' = Br

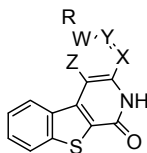

- 10 X=Y=Z= CH; R= H; W= NH⁺Cl⁻
 11 X= N; Y=Z= CH; R= CN; W= C
 12 X=Z= CH; Y=N; W=C;
 13 X=Y= CH; Z= N; W=C;
 14 X= N; Y=Z= CH; W=C;
 } R = H⁺Cl⁻

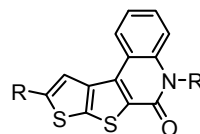

- 15 R = H; R' = (CH₂)₃N(CH₃)₂
 16 R = COOCH₃; R' = (CH₂)₃N(CH₃)₂
 17 R = CONH(CH₂)₃N(CH₃)₂; R' = H

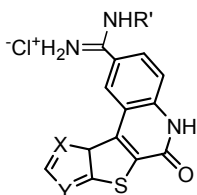

- 18 X=C, Y=S, R' = H
 19 X=C; Y=S, R' = CH(CH₃)₂
 20 X=S, Y=C, R' = H
 21 X=S, Y=C, R' = CH(CH₃)₂

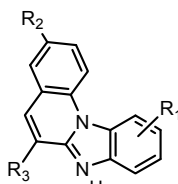

- 22 R₁=H, R₂=H, R₃=H
 23 R₁=CN, R₂=H, R₃=H

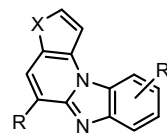

- 24 R=H, X=S, R' = N-CH₃
 25 R=CN, X= N-CH₃; R'=H

The change of the terminal benzene nuclei of the acidic part of the molecule with thiophene in quinolones didn't significantly influenced on the antitumor activity, while the substitution of the quinolone nuclei with the naphthyridone nuclei increased antitumor activity. Quinolones and quinolines showed very similar and good antitumor activity. DNA binding reactions were detected by changes in fluorescence, UV and CD spectra.

Termodinamička svojstva RbBr i CsBr u smjesi 2-butanola (5 mas.%) + voda

UDC: 549.4 : 544.3

V. Sokol*, R. Tomaš, K. Šarić

Sveučilište u Splitu, Kemijsko-tehnološki fakultet, Teslina 10/IV, 21000 Split, Hrvatska

Sažetak

Mjerena je vodljivost razrijeđenih otopina rubidijevog i cezijeveog bromida u smjesi 2-butanola i vode s 5 mas. % alkohola pri pet temperatura u području od 15 °C do 35 °C. U obradi je korišten model provodnosti utemeljen na jednadžbi Lee-Wheaton. Podešavanje triju parametara nije dalo ujednačene vrijednosti asocijacijskog razmaka R . Stoga je za fiksnu vrijednost tog parametra odabran Bjerrumov kritični razmak ($R = q$). Ponovljenom obradom dobivena su rješenja za graničnu molarnu provodnost (A_0) i konstantu asocijacije (K_A) pri svakoj temperaturi te su izvedene termodinamičke veličine za reakciju asocijacije (ΔG° , ΔH° i ΔS°) pri 25 °C. Dobivene termodinamičke veličine, skupa s Waldenovim produktom, uspoređene su s onima za RbBr i CsBr u 70, 80, 90 i 95 mas. %-tnom 2-butanolu iz literature. Termodinamičke veličine pokazuju da je asocijacijska reakcija spontana, endotermna i vodi ka povećanju nereda u sustavu; sve te osobine više su izražene u smjesama s većim sadržajem alkohola.

Ključne riječi: smjese 2-butanola i vode, RbBr, CsBr, ionska asocijacija, termodinamičke veličine

Uvod

Kao reakcijski medij posebno su zanimljiva miješana otapala (najčešće su to smjese vode i nekog organskog spoja), jer se njihova svojstva, kao što su relativna električna permitivnost (ϵ_r), viskoznost (η) i gustoća (ρ), znatno mijenjaju promjenom udjela sastojaka. U otapalima niske relativne električne permitivnosti dolazi do reakcije ionske asocijacije. Brojni su radovi gdje se u istom otapalu mjeri vodljivost niza elektrolita sa zajedničkim ionom te izvodi i uspoređuje konstanta reakcije asocijacije (K_A) i Waldenov produkt ($A_0\eta$).

U našim dosadašnjim istraživanjima (Tominić et al., 1998; Sokol et al., 2005, 2006, 2008a, 2008b) ispitan je utjecaj alkalijskih metala na transportna i ravnotežna svojstva njihovih bromida u smjesama 2-butanola i vode s masenim udjelom alkohola (w) 70, 80, 90 i 95 %. U ovom radu nastavljena su istraživanja rubidijevog i cezijeveog bromida u smjesi s niskim masenim udjelom alkohola, $w = 5$ %, u temperaturnom području od 15 °C do 35 °C. Sustav 2-butanol + voda je dvofazan između $w = 17,5$ % i $w = 64,8$ % pri 25°C

* vsokol@ktf-split.hr

(Ochi et al., 1996). U obradi podataka korišten je kemijski model provodnosti utemeljen na Lee-Wheatonovoj jednadžbi (LWPT). Izračunate su vrijednosti granične molarne provodnosti (Λ_0), konstanta reakcije asocijacije i Waldenov produkt ($\Lambda_0\eta$). Gibbsova energija (ΔG^0), entalpija (ΔH^0) i entropija (ΔS^0) reakcije asocijacije iona Rb^+ i Cs^+ s Br^- izvedene su iz temperaturne ovisnosti konstante asocijacije. Sve dobivene vrijednosti uspoređene su s onima za RbBr (Sokol et al., 2008 a) i CsBr (Sokol et al., 2008 b) u smjesama 2-butanola i vode s masenim udjelom alkohola 70, 80, 90 i 95 %.

Materijali i metode

Za pripremu radnih otopina korišteni su redestilirana voda (električna provodnost $\sim 10^{-6} \text{ S cm}^{-1}$), 2-butanol (Merck, p.a.), RbBr i CsBr (Merck, suprapur). 2-butanol je destilirana u Vigreuxovoj koloni. Prva i zadnja frakcija destilata su odbačene dok je srednja frakcija korištena za pripremu radnih otopina. RbBr i CsBr su sušeni na 105°C do konstantne mase. Čisto 5 %-tno miješano otapalo priprema se vaganjem 2-butanola i redestilirane vode. Matična otopina ima najveću koncentraciju elektrolita u miješanom otapalu i koristi se za pripremu radnih otopina manjih koncentracija.

Za mjerenje otpora radnih otopina korišten je LCR-metar Wayne-Kerr 6430 A koji je povezan s uranjajućom konduktometrijskom ćelijom Orion 018001. Točnost mjerenja je 0,02 %, napon se može mijenjati u rasponu od 0 do 2 V, a frekvencija od 20 Hz do 500 kHz. Otpori su mjereni pri frekvencijama od 500, 800, 1000 i 2000 Hz pri izlaznom naponu od 400 mV. Ćelija je termostatirana u kupelji Thermo Haake DC 10 – V 15/B koja održava temperaturu unutar $\pm 0,01 \text{ K}$. Za homogeniziranje radnih otopina korištena je uronjiva magnetska miješalica HMC Cyclone Power 7. Prije mjerenja otpora radnih otopina određena je konstanta ćelije baždarenjem s razrijeđenim otopinama KCl (Barthel et al., 1980). Srednja vrijednost konstante ćelije iznosi $C = 0,10402 \text{ cm}^{-1}$.

U staklenu čašu od 150 cm^3 odvažuje se 100 g čistog miješanog otapala i stavi magnetski štapić za miješanje. Čaša se hermetički zatvori teflonskim poklopcem koji ima tri otvora: za konduktometrijsku ćeliju, cjevčicu za dovod dušika radi uklanjanja CO_2 , te za dodavanje matične otopine injekcijskom špricom. Čaša se stavi u kupelj pri 15°C , temperira 30 minuta te izmjeri otpor čistog otapala pri četiri frekvencije. Radne otopine sve većih molaliteta dobivene su dodavanjem matične otopine u obrocima od 1 g. Masa dodane matične otopine dobijena je vaganjem injekcijske šprice prije i nakon injektiranja. Isto se ponovi na radnim temperaturama od 20, 25, 30 i 35°C . Ovisnost otpora o recipročnoj vrijednosti frekvencije ($1/f$) može se prikazati pravcem. Otpor radne otopine R_0 određuje se ekstrapolacijom pravca na beskonačno veliku frekvenciju ($1/f = 0$).

Molarna provodnost radnih otopina računa se prema izrazu:

$$A = (10^3/c)(C/R_0 - L_s), \quad (1)$$

gdje je L_s električna provodnost čistog otapala, a C konstanta ćelije. Koncentracija ($c / \text{mol dm}^{-3}$) određuje se iz molaliteta i gustoće prema izrazu:

$$c = m\rho/(1 + Mm), \quad (2)$$

gdje su m molalitet (mol (elektrolita) / kg (otapala)), ρ gustoća otopine, M molarna masa elektrolita ($M_{\text{RbBr}} = 0,16538 \text{ kg mol}^{-1}$, $M_{\text{CsBr}} = 0,21281 \text{ kg mol}^{-1}$). Gustoća matične otopine određena je piknometrom na 20 °C. Gradijent gustoće ($D / \text{kg}^2 \text{ dm}^{-3} \text{ mol}^{-1}$) je određen uz pretpostavku da gustoća otopine pokazuje linearnu ovisnost o molalitetu:

$$\rho = \rho_0 + Dm, \quad (3)$$

ρ_0 je gustoća čistog miješanog otapala. Pretpostavljeno je da isti gradijent gustoće vrijedi i pri ostalim temperaturama (Bešter-Rogač et al., 1999). Njegove su vrijednosti 0,126 za RbBr, odnosno 0,194 za CsBr.

Rezultati i rasprava

U Tablici 1 prikazana su svojstva miješanog otapala 2-butanol + voda s masenim udjelom alkohola izraženim u postocima $w = 5 \%$. Gustoća (ρ_0) određena je piknometrom, a koeficijent viskoznosti (η) Ostwaldovim viskozimetrom. Vrijednosti relativne električne permitivnosti (ϵ_r) preuzete su iz literature (Szejgis et al., 1997).

Tablica 1. Gustoća, viskoznost i relativna permitivnost 5 mas. %- tnog 2-butanola

Table 1. Density, viscosity and relative permittivity of 2-butanol (5 mass. %) + water mixture

	15 °C	20 °C	25 °C	30 °C	35 °C
$\rho / \text{g cm}^{-3}$	0,9920	0,9909	0,9898	0,9883	0,9860
$10^3 \eta / \text{Pa s}$	1,4123	1,2233	1,0624	0,9311	0,8417
ϵ_r	78,3	76,5	74,7	73,0	71,3

U Tablici 2 prikazane su molarne provodnosti ($A / \text{S cm}^2 \text{ mol}^{-1}$) otopina RbBr odnosno CsBr koncentracije c u 5 mas. % tnom 2-butanolu.

Tablica 2. Molarne provodnosti (Λ) otopina RbBr i CsBr različitih koncentracija (c) u 5 mas. % tnom 2-butanolu^a

Table 2. Molar conductivities (Λ) of RbBr and CsBr at various concentrations (c) in 2-butanol (5 mass. %) + water mixture^a

15 °C		20 °C		25 °C		30 °C		35 °C	
10 ⁴ c	Λ	10 ⁴ c	Λ	10 ⁴ c	Λ	10 ⁴ c	Λ	10 ⁴ c	Λ
RbBr									
84,259	91,142	102,93	100,5	101,48	111,61	99,066	124,38	99,185	136,16
71,832	91,478	96,844	100,72	95,782	112,01	93,242	124,69	93,180	136,54
65,182	91,774	90,818	100,99	89,867	112,21	87,435	124,93	87,345	137,40
58,187	92,007	84,266	101,33	83,949	112,48	81,473	124,93	81,397	137,60
51,219	92,344	77,979	101,63	77,764	112,82	75,291	125,33	75,102	138,00
44,729	92,573	71,623	101,94	71,515	113,08	69,049	125,86	68,916	138,79
37,711	92,733	65,185	102,33	65,146	113,38	62,453	126,23	62,706	138,78
31,025	92,973	58,675	102,82	58,223	114,31	55,927	126,95	56,078	139,13
23,898	93,697	51,774	103,15	51,626	114,69	49,646	127,34	49,312	139,66
15,547	94,381	44,740	103,62	44,653	115,13	42,765	127,86	42,563	140,40
8,1192	94,761	37,747	104,09	38,028	115,54	35,853	128,56	35,783	141,13
		30,586	104,65	31,148	115,86	28,776	129,15	28,919	142,17
		23,138	105,16	23,932	116,34	21,985	129,95	22,129	141,86
		15,768	105,85	16,032	118,13	14,753	130,85	14,837	143,18
		8,0631	106,71	7,8472	119,07	7,3577	132,06	7,4904	144,98
CsBr									
99,225	95,104	99,115	106,99	99,005	119,27	98,855	132,12	98,626	145,50
88,268	95,947	88,171	107,99	88,073	120,56	87,940	133,55	87,735	147,08
73,523	96,851	73,441	109,00	73,360	121,59	73,249	134,77	73,079	148,44
68,934	97,050	68,858	109,24	68,782	121,93	68,678	135,08	68,518	148,73
61,481	97,167	61,413	109,41	61,345	122,04	61,252	135,25	61,110	148,91
54,052	97,506	53,992	109,82	53,932	122,7	53,850	135,76	53,725	149,53
46,616	98,194	46,565	110,55	46,513	123,68	46,443	136,68	46,335	150,55
39,190	99,279	39,147	111,86	39,103	124,85	39,044	138,56	38,953	152,45
24,298	99,808	24,271	112,54	24,244	125,67	24,207	139,37	24,151	153,52
16,878	100,59	16,859	113,39	16,841	126,54	16,815	140,32	16,776	154,62
9,4198	102,32	9,4094	115,33	9,3989	128,82	9,3847	142,87	9,3629	157,41

^a Λ / S cm² mol⁻¹; c / mol dm⁻³

Molarna provodnost A opada porastom koncentracije otopljene soli, a raste porastom temperature. Eksperimentalni podaci obrađeni su sljedećim jednadžbama:

$$A_{c\alpha} = A_0 \left[1 + C_1 \beta \kappa + C_2 (\beta \kappa)^2 + C_3 (\beta \kappa)^3 \right] - \frac{\rho \kappa}{1 + \kappa R} \left[1 + C_4 \beta \kappa + C_5 (\beta \kappa)^2 + \frac{\kappa R}{12} \right] \quad (4)$$

$$K_A = (1 - \alpha) / (c \alpha^2 y_{\pm}^2) \quad (5)$$

$$y_{\pm}^2 = \exp[-2 \kappa q / (1 + \kappa R)] \quad (6)$$

$$\rho = \frac{F e}{3 \pi \eta} \quad (7)$$

$$q = \frac{e^2}{8 \pi \epsilon_0 \epsilon_r k T} \quad (8)$$

$$\kappa^2 = 16 \pi N_A q \alpha c \quad (9)$$

Konduktometrijska jednadžba Lee-Wheaton u verziji Pethybridgea i Tabe (1980) (LWPT) dana je izrazom (4). $A_{c\alpha}$ je molarna provodnost slobodnih iona, A_0 je molarna provodnost kod beskonačnog razrjeđenja ili granična molarna provodnost, koeficijenti $C_1 - C_5$ su složene funkcije od t i $\ln t$ ($t = \kappa R$), R je asocijacijski razmak, κ je Debyeov parametar, $\beta = 2q$, q je Bjerrumov kritični razmak. K_A je termodinamička konstanta ravnoteže za reakciju asocijacije:



gdje M^+ predstavlja katione Rb^+ odnosno Cs^+ , $c\alpha$ i $c(1-\alpha)$ su ravnotežne koncentracije frakcije slobodnih iona odnosno ionskih parova, α je stupanj disocijacije ($\alpha = A/A_{c\alpha}$) i predstavlja omjer izmjerene molarne provodnosti (A) i molarne provodnosti slobodnih iona, y_{\pm} je srednji koeficijent aktiviteta slobodnih iona. Parametri A_0 , K_A i R izvedeni su postupkom "poboljšavanja" pod kojim se misli na postupno približavanje "najboljim" vrijednostima parametara polazeći od njihovih grubih aproksimacija. To se izvodi matematičkim metodama kojima se ponavljaju određene sekvence računa (iteracija). U ovom radu korišten je postupak kojim se koristio Beronius (1974) gdje se A_0 i K_A prilagođavaju za svaku odabranu vrijednost parametra R . "Poboljšavanje" je gotovo kad se postigne minimalna standardna devijacija:

$$\sigma^2 = \Sigma (A_{\text{eksp}} - A_{\text{rač}})^2 / (n-3) \quad (11)$$

između eksperimentalnih i izračunatih provodnosti. Dobivene vrijednosti parametara Λ_0 i K_A imaju ujednačeni trend promjene s temperaturom. Vrijednosti parametra R nepredvidivo se mijenjaju s temperaturom što dovodi u pitanje i vrijednosti preostala dva parametra. Stoga je prema prijedlogu Justicea (1971) asocijacijski razmak izjednačen s Bjerrumovim kritičnim razmakom $R = q$ i obrada ponovljena. U Tablici 3 prikazane su vrijednosti granične molarne provodnosti (Λ_0), konstante asocijacije (K_A) i standardne devijacije eksperimentalnih Λ od modela LWPT (σ).

Tablica 3. Granična molarna provodnost (Λ_0), konstanta asocijacije (K_A) i standardna devijacija (σ) eksperimentalnih Λ od modela LWPT za otopine RbBr i CsBr u 5 %-tnom 2-butanolu

Table 3. Limiting molar conductivity (Λ_0), ion-association constant (K_A) and standard deviation (σ) of experimental Λ from the model LWPT for RbBr and CsBr solutions in 2-butanol (5 mass. %) + water mixture

$\theta / ^\circ\text{C}$	$\Lambda_0 / \text{S cm}^2 \text{mol}^{-1}$	K_A	$\sigma / \text{S cm}^2 \text{mol}^{-1}$	$R=q / \text{nm}$
RbBr				
15	96,88	0,98	0,04	0,370
20	109,07	2,60	0,07	0,373
25	121,41	2,86	0,24	0,375
30	134,95	2,94	0,08	0,378
35	148,17	2,68	0,17	0,380
CsBr				
15	104,15	4,41	0,32	0,370
20	117,50	4,67	0,35	0,373
25	131,33	4,75	0,38	0,375
30	145,71	4,87	0,49	0,378
35	160,54	4,92	0,51	0,380

Granična molarna provodnost Λ_0 raste s porastom temperature što se može objasniti smanjenjem viskoznosti smjese otapala. Konstanta asocijacije također raste s porastom temperature. Razlog tomu je smanjenje relativne permitivnosti otapala. Pri konstantnoj temperaturi vrijednosti parametara Λ_0 i K_A za CsBr veće su od onih za RbBr. Provodnost i asocijacija trebale bi prema Stokesu i Bjerrumu rasti sa smanjenjem srednjeg ionskog promjera, a to znači da bi Λ_0 i K_A za RbBr trebale biti veće. Odnos parametara suprotan od očekivanog posljedica je dominantnog utjecaja solvatacije iona.

Vrijednosti Λ_0 , K_A i Waldenov produkt $\Lambda_0\eta$ za RbBr i CsBr usporedene su s onima u 70, 80, 90 i 95 %-tnom 2-butanolu (Sokol et al., 2008a, 2008b). Na Slici 1 prikazane su vrijednosti granične molarne provodnosti za RbBr i CsBr u 5, 70, 80, 90 i 95 %-tnom 2-butanolu, kao i viskoznost čistog otapala pri 25 °C.

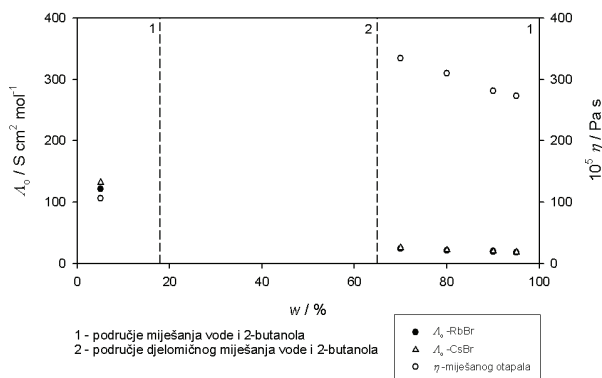

Slika 1. Granična molarna provodnost (Λ_0) za RbBr (●) i CsBr (Δ) u 5, 70, 80, 90 i 95 mas. %-tnom 2-butanolu pri 25 °C; viskoznost (η) (○) miješanog otapala pri 25 °C
Fig. 1. Molar conductivity (Λ_0) of RbBr (●) and CsBr (Δ) in 5, 70, 80, 90 and 95 mass. % 2-butanol at 25 °C; viscosity (η) (○) of 2-butanol + water mixtures

Viskoznost 5 %-tnog miješanog otapala niža je od viskoznosti smjesa s većim udjelom 2-butanola. Granična molarna provodnost elektrolita u 5 %-tnom 2-butanolu je veća od one u području 70-95 % 2-butanola. U području s većim udjelom alkohola viskoznost i granična molarna provodnost se smanjuju s povećanjem masenog udjela 2-butanola. Smanjenje granične molarne provodnosti uzrokovano je povećanom solvatacijom iona. Na Slici 2 prikazane su vrijednosti konstante asocijacije za RbBr i CsBr u 5, 70, 80, 90 i 95 %-tnom 2-butanolu pri 25 °C.

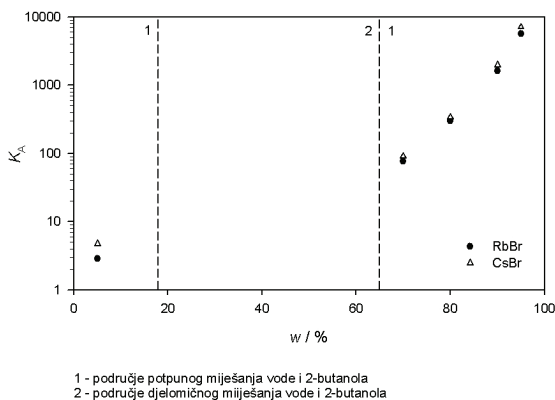

Slika 2. Konstanta asocijacije (K_A) za RbBr (●) i CsBr (Δ) u 5, 70, 80, 90 i 95 mas. %-tnom 2-butanolu pri 25 °C
Fig. 2. Ion-association constant (K_A) for RbBr (●) and CsBr (Δ) in 5, 70, 80, 90 and 95 mass. % 2-butanol at 25 °C

Konstanta asocijacije izrazito je veća u smjesama s većim udjelom alkoholne komponente, tako da je u 90 i 95 %-tnom 2-butanolu K_A više od tisuću puta veća od K_A u 5 %-tnom 2-butanolu. Ravnoteža je tada jako pomaknuta na stranu produkata, odnosno nastanku asociiranih ionskih parova. Glavni razlog tomu je smanjenje relativne permitivnosti otapala. Waldenov produkt $\Lambda_{0,7}$ rubidijevog i cezijeve bromida u 5, 70, 80, 90 i 95 %-tnom 2-butanolu prikazan je na Slici 3.

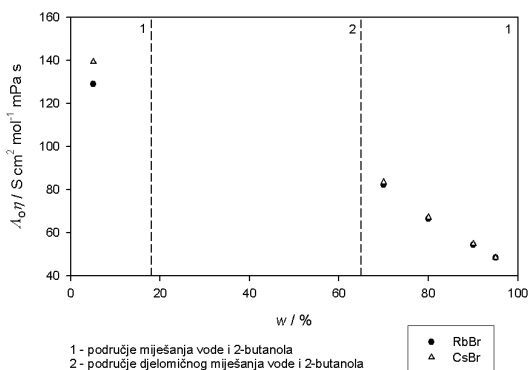

Slika 3. Waldenov produkt za RbBr (●) i CsBr (Δ) u 5, 70, 80, 90 i 95 mas. %-tnom 2-butanolu pri 25 °C

Fig. 3. Walden product for RbBr (●) and CsBr (Δ) in 2-butanol + water mixtures at 25 °C

Smanjenje Waldenovog produkta povećanjem udjela organskog otapala posljedica je porasta bazičnosti organskog otapala. Povećanjem bazičnosti otapala raste debljina solvacijskih ljuski oko kationa što uzrokuje manju gibljivost kationa, a time i Waldenov produkt. Usporedbom Waldenovog produkta za RbBr i CsBr odnos je suprotan od očekivanog prema rastućem ionskom polumjeru. Kristalografski polumjer Cs^+ (0,169 nm) iona je veći od Rb^+ (0,148 nm) (Barthel et al., 1998), iz čega proizlazi da bi njegova pokretljivost, odnosno Waldenov produkt, trebali biti manji. Stvarno stanje je upravo suprotno od navedenog, a to ukazuje na jaču solvataciju Rb^+ iona u odnosu na Cs^+ . Posljedica jače solvatacije je veći hidrodinamički polumjer iona koji uzrokuje njihovu slabiju pokretljivost, odnosno smanjenje Waldenovog produkta. Razlike među elektrolitima u tom produktu znatno su manje pri većem udjelu alkohola. Najvjerojatnije, tu počinje nedostajati vodenih molekula za primarnu solvataciju kationa i debljine njihovih solvacijskih omotača se ujednačuju.

Standardne termodinamičke veličine za reakciju asocijacije iona Rb^+ , odnosno, Cs^+ i Br^- računaju se iz vrijednosti termodinamičke konstante asocijacije K_A pri

pet temperatura (Tablica 3). Prirast entalpije (ΔH^0) određuje se iz nagiba pravca u dijagramu $\ln K_A - 1/T$ prema jednadžbi:

$$\ln K_A = - \Delta H^0 / (RT) + C \quad (12)$$

a prirast molarne Gibbsove energije (ΔG^0) i prirast entropije (ΔS^0) računaju se prema jednadžbama:

$$\Delta G^0 = - RT \ln K_A, \quad (13)$$

$$\Delta S^0 = (\Delta H^0 - \Delta G^0) / T \quad (14)$$

U Tablici 4 prikazane su vrijednosti standardnih termodinamičkih veličina dobivenih pri 25 °C.

Tablica 4. Termodinamičke veličine za reakciju ionske asocijacije RbBr i CsBr u 5 %-tnom 2-butanolu pri 25 °C

Table 4. Thermodynamic quantities of ion-association reaction for RbBr and CsBr in 2-butanol (5 mass. %) + water mixture at 25 °C

	$\Delta H^0 / \text{J mol}^{-1}$	$\Delta G^0 / \text{J mol}^{-1}$	$\Delta S^0 / \text{J K}^{-1} \text{mol}^{-1}$
RbBr	9114	-2596	39,3
CsBr	3870	-3860	25,9

Reakcija ionske asocijacije je endotermna i spontana. Endotermne reakcije mogu biti spontane ako im je entropijski član ($T\Delta S^0$) veći od ΔH^0 kao što je ovdje upravo slučaj. Na Slici 4 prikazane su ovisnosti ΔG^0 , ΔH^0 i $T\Delta S^0$ asocijacijske reakcije RbBr i CsBr u 5, 70, 80, 90 i 95 %-tnom 2-butanolu pri 25 °C.

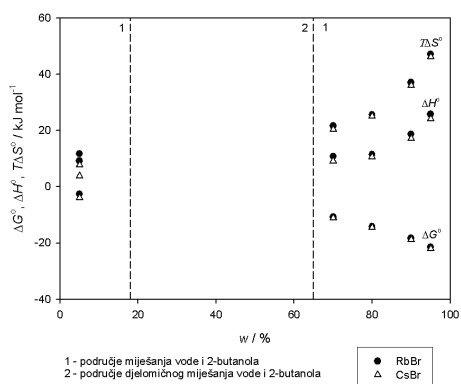

Slika 4. Veličine ΔG^0 , ΔH^0 i $T\Delta S^0$ asocijacijske reakcije za RbBr (●) i CsBr (Δ) u 5, 70, 80, 90 i 95 mas. %-tnom 2-butanolu pri 25 °C

Fig. 4. Values of ΔG^0 , ΔH^0 and $T\Delta S^0$ for the ion-pair formation of RbBr (●) and CsBr (Δ) in 5, 70, 80, 90 and 95 mass. % 2-butanol at 25 °C

Vrijednost standardnog prirasta Gibbsove energije je negativna za oba elektrolita i smanjuje se s povećanjem masenog udjela 2-butanola. Iz toga proizlazi da je reakcija asocijacije spontana, a ravnoteža pomaknuta više na desno kako raste udio 2-butanola u smjesi (niža relativna permitivnost).

ΔG° za RbBr je pozitivniji od CsBr u svim smjesama 2-butanola i vode. Položaj ΔG° krivulja ovisi o solvacijskim svojstvima elektrolita. Jača solvatacija znači slabiju sklonost ka nastanku ionskih parova, odnosno pozitivniji ΔG° .

Vrijednosti standardnih prirasta entalpije i entropije su pozitivne i rastu s porastom udjela alkohola u miješanom otapalu. Entropijski član $T\Delta S^\circ$ prevladava u odnosu na ΔH° , a to ukazuje na jake strukturne efekte gdje razgradnja solvacijskog omotača dominira nad izgradnjom strukture otapala i smanjenjem broja slobodnih iona zbog asocijacije.

Zaključak

Reakcija asocijacije je spontana, a prinos ionskih parova raste s porastom masenog udjela 2-butanola u smjesi. RbBr jače solvatira od CsBr u svim smjesama 2-butanola i vode. Jača solvatacija znači slabiju sklonost ka nastanku ionskih parova. Razlike Waldenovog produkta među elektrolitima znatno se smanjuju sa povećanjem masenog udjela 2-butanola u smjesi, iz čega se može zaključiti da se smanjuju i razlike u solvataciji iona. Veličine ΔH° i ΔS° su pozitivne i rastu s porastom udjela 2-butanola u miješanom otapalu. Asocijacija je endotermna reakcija i vodi ka povećanju nereda u sustavu. Entropijski član prevladava u odnosu na ΔH° , a to ukazuje na jake strukturne efekte koji su najvjerojatnije rezultat dvaju strukturno suprotnih procesa: razgradnje solvacijskog omotača i izgradnje mase otapala.

Literatura

- Barthel, J., Feuerlein, F., Neueder, R., Wachter, R. (1980): Calibration of conductance cells at various temperatures, *J. Solution Chem.* 9, 209-219.
- Barthel, J., Krienke, H., Kunz, W. (1998): Physical Chemistry of Electrolyte Solutions: Modern Aspects; New York,Steinkopff/Darmstadt, Springer, pp. 37.
- Beronius, P. (1974): Interpretation of kinetic data for reactions involving ions and ion-pairs using an extended conductance equation, *Acta. Chem. Scand. A*, 28, 77-82.
- Bešter-Rogač, M., Neueder, R., Barthel, J. (1999): Conductivity of sodium chloride in water + 1,4-dioxane mixtures at temperatures from 5 to 35°C. I. Dilute solutions, *J. Solution Chem.* 28, 1071-1086.
- Justice, J. C. (1971): An Interpretation for the Distance Parameter of the Fuoss-Onsager Conductance Equation in the Case of Ionic Association, *Electrochim. Acta*, 16, 701-712.
- Ochi, K., Saito, T., Kojima, K. (1996): Measurement and correlation of mutual solubilities in 2-butanol + water, *J. Chem. Eng. Data* 41, 361-364.
- Pethybridge, A.D., Taba, S.S. (1980): Precise conductometric studies on aqueous solutions of 2:2 electrolytes. Part 2.-Analysis of data for $MgSO_4$ in terms of new equations from Fuoss and from Lee and Wheaton, *J. Chem. Soc. Faraday Trans. I*, 76, 368-376.

- Sokol, V., Tominić, I., Tomaš, R., Višić, M. (2005): Thermodynamics of the association reaction of Li^+ and Br^- ions in 2-butanol+water mixtures from conductivity measurements, *Croat. Chem. Acta* 78, 43–47.
- Sokol, V., Tomaš, R., Višić, M., Tominić, I. (2006): Conductometric study of potassium bromide in 2-butanol + water mixtures, *J. Solution Chem.* 35, 1687–1698.
- Sokol, V., Tomaš, R., Tominić, I. (2008 a): Thermodynamics of the association reaction of RbBr in binary mixtures of 2-butanol and water from 288.15 to 308.15 K, *Acta Chimica Slovenica* 55, 308-314.
- Sokol, V., Tomaš, R., Tominić, I. (2008 b): Conductometric study of cesium bromide in 2-butanol + water mixtures, *Polish J. Chem.* 82 1585-1596.
- Szejgis, A., Bald, A., Gregorowicz, J., Kinart, C.M. (1997): Conductivity studies on LiBr, NaBr, KBr and CsBr solutions in binary mixtures of N,N-dimethylformamide with water at 298.15 K, *Phys. Chem. Liq.* 34, 189–199.
- Tominić, I., Sokol, V., Mekjavić, I. (1998): Thermodynamics of the association reaction of Na^+ and Br^- ions in (70, 80, 90 and 95 mass per cent) 2-butanol+water mixtures. *Croat. Chem. Acta* 71, 705–714.

Thermodynamic properties of RbBr and CsBr in 2-butanol (5 mass.%) + water mixture

V. Sokol, R. Tomaš, K. Šarić

University of Split, Faculty of Chemistry and Technology, Teslina 10/V, 21000 Split, Croatia

Summary

Molar conductivities of dilute solutions of rubidium and cesium bromide in binary mixture of 2-butanol and water with 5 mass. % alcohol content were measured in the temperature range from 15 °C to 35 °C. Data were processed using conductivity model based on the Lee-Wheaton equation. A three-parameter adjustment did not give uniform values for the association distance R . Therefore, the Bjerrum critical distance was chosen as a fixed value of that parameter ($R = q$). By repeated treatment, the limiting molar conductivity (A_0) and the ion-pair formation constant (K_A) were solved at each temperature, and the thermodynamic quantities of the association reaction (ΔG° , ΔH° and ΔS°) were derived at 25 °C. The obtained thermodynamic quantities, together with Walden product, were compared with the literature data for RbBr and CsBr in mixtures with 2-butanol mass fraction (w) 70, 80, 90 and 95 %. From thermodynamic quantities it is seen that the association reaction is spontaneous, endothermic and leads to an increased disorder in the system; all these features are more pronounced in mixtures with a higher alcohol content.

Keywords: 2-butanol + water mixtures, RbBr, CsBr, association to ion-pairs, thermodynamic quantities

Termodinamička svojstva CdCl₂ u smjesi terc. butanol (5 mas. %) + voda

UDC: 546.48-386 : 544.3

R. Tomaš*, V. Sokol, P. Bošković

*Sveučilište u Splitu, Kemijsko-tehnološki fakultet, Zavod za fizikalnu kemiju, Teslina 10/V,
21000 Split, Croatia*

Sažetak

Mjerena je elektromotivnost galvanskog članka bez prijenosa: Cd(Hg) (1, zas.) | CdCl₂(b), *t*-butanol (5 mas. %) + voda | AgCl(s) | Ag(s), uz povećanje molalитета (*b*) kontinuiranim dodavanjem koncentrirane otopine elektrolita u temperaturnom području (293.15 K – 313.15 K) u intervalu po 5 K. Izmjerene vrijednosti upotrijebljene su za dobivanje standardne molalne elektromotivnosti članka (E_b°) za pojedine temperature prema metodi koja uzima u obzir reakcije nastajanja klorokadmijevih kompleksa. Konstante stabilnosti tih kompleksa nisu mjerene već su dobivene interpoliranjem u literaturne podatke. Iz vrijednosti za E_b° izračunate su standardne termodinamičke veličine za reakciju članka i srednji stehiometrijski koeficijenti aktiviteta CdCl₂. Dobivene termodinamičke veličine uspoređene su s onima u sličnim sustavima.

Ključne riječi: kadmijev klorid, smjesa *t*-butanol + voda, potenciometrija, termodinamičke veličine

Uvod

Miješana otapala (*Z*) sastavljena od vode (*W*) i organskog otapala (*S*) značajan su reakcijski medij za odvijanje raznih kemijskih reakcija. Mijenjanjem odnosa sastojaka u smjesi mijenjaju se njene fizikalno-kemijske karakteristike što može utjecati na brzinu i mehanizam te na položaj ravnoteže takvih reakcija. Svojstva miješanih otapala mogu se upoznati posredno preko njihovog utjecaja na elektrokinetičko i termodinamičko ponašanje otopljenog elektrolita. Pregledom novije literature vidi se da značajnu ulogu u upoznavanju termodinamike elektrolita u miješanim otapalima ima potenciometrija reverzibilnih galvanskih članaka (Deyhimi et al., 2003; Rui-Fang et al., 2007; Hernández-Luis et al., 2009).

U našem laboratoriju termodinamička svojstva kadmijevog klorida (CdCl₂) proučavana su mjerenjem elektromotivnosti (*E*) (Simeon, 2004) kemijskog članka bez prijenosa:



* rtomas@ktf-split.hr

u vodenom mediju (Višić i Mekjavić, 1989) i u raznim miješanim otapalima Z s masenim udjelom (w_s) od 10, 30 i 50 % 2-propanola (Višić i Mekjavić, 1993), acetona (Višić i Mekjavić, 1996) i *t*-butanola (Tomaš et al., 2000), odnosno od 5, 10 i 15 % 2-butanona (Tomaš et al., 2004) i 2-butanola (Tomaš et al., 2005). Eksperimentalna metoda mjerenja E članka (1) u funkciji molaliteta (b) CdCl_2 ovdje je uključivala pripremu svake radne otopine pojedinačno vaganjem. Ovakav način izvedbe eksperimenta je vrlo težak te značajno smanjuje brzinu mjerenja. Dobiveni potenciometrijski podaci poslužili su za izračunavanje srednjih stehiometrijskih koeficijenata aktiviteta CdCl_2 i ostalih termodinamičkih veličina. Slično istraživanje obavljeno je u ovom radu primijenjujući metodu kontinuirane potenciometrije (Zhang et al., 1993), prema kojoj se znatno brže dolazi do pouzdanih rezultata. Metoda uključuje promjenu molaliteta kontinuiranim dodavanjem koncentrirane otopine elektrolita za vrijeme mjerenja elektromotivnosti članka pri određenoj stalnoj temperaturi. U cilju provjere metode prvo su redeterminirane termodinamičke veličine za CdCl_2 u vodi pri 298.15 K i uspoređene s literaturom. Zatim je ta sol istim načinom ispitana u smjesi $Z = t$ -butanol ($w = 5\%$) + voda. Kako za taj sustav ne postoje objavljeni podaci, dobiveni rezultati uspoređeni su s onima u sličnim sustavima. Potenciometrija članka (1) u 5 % *t*-butanolu obavljena je za 15 različitih molaliteta CdCl_2 pri svakoj od 5 temperatura iz područja od 293.15 K do 313.15 K.

Za izračunavanje standardne elektromotivnosti članka (E_b°) korištena je metoda koja uzima u obzir reakcije nastajanja klorokadmijevih kompleksa (Višić i Mekjavić, 1989). Ranija istraživanja u vodi (Višić et al., 1993) i u 10 % *t*-butanolu (Višić et al., 1999) pokazala su da u tim sustavima dolazi do nastajanja tri vrste kompleksa:



s pripadajućim konstantama ravnoteže iz kojih su vrijednosti za 5 % *t*-butanol interpolirane.

Materijali i metode

Kemikalije i otopine

Kemikalije upotrijebljene u ovom radu bile su *p.a.* kvalitete. Koncentrirana otopina elektrolita pripremljena je vaganjem $\text{CdCl}_2 \times \text{H}_2\text{O}$ (Kemika), redestilirane vode i destiliranog *t*-butanola (Riedl-de Häen), uzevši u obzir da sol sadrži jednu molekulu kristalne vode. Molalitet tako pripremljene otopine iznosio je $0.05050 \text{ mol kg}^{-1}$ s masenim udjelom soli od 1.006 %. Pored te otopine odvojeno je pripremljeno i miješano otapalo vaganjem vode (95 %) i *t*-butanola (5 %). Gustoća (d) tako pripremljenog otapala određena je pomoću

mjerača gustoće (Anton Paar DMA 4500 M) točnosti 0.05 kg m^{-3} . Unutar mjerača nalazi se termopar (Peltierov element) koji grije odnosno hladi uzorak u širokom temperaturnom području. Nakon postizanja termičke ravnoteže ($\pm 0.01 \text{ K}$) određene su gustoće pri svim radnim temperaturama (vidi Tablicu 2). Uređaj je prethodno kalibriran s redestiliranom vodom.

Elektrode i aparatura

Kao radne elektrode u članku (1) korištene su zasićena Cd(Hg) s $w = 11 \%$ Cd i AgCl | Ag. Priprema, čuvanje i odabir elektroda za mjerenje opisano je u literaturi (Višić i Mekjavić, 1989; Tomaš et al., 2004). Za mjerenje elektromotivnosti članka (1) pri $T = 293.15, 298.15, 303.15, 308.15$ i 313.15 K upotrebljen je voltmetar velikog ulaznog otpora (Keithley Electrometer 6514) rezolucije $\pm 0.00001 \text{ V}$. Isti uređaj je korišten za provjeru stabilnosti potencijala elektrode AgCl | Ag. Potenciometrijska ćelija bila je staklena posuda zapremine oko 300 mL . Zatvorena je silikonskim čepom koji ima tri otvora: jedan za elektrodu AgCl | Ag, drugi za cjevčicu kroz koju prolazi dušik i treći za injektiranje uzorka. Za termostatiranje ćelije (30 minuta) korišten je ultra-termostat (U10) koji temperaturu održava stalnom u granicama $\pm 0.02 \text{ K}$. Više detalja vezano za opis ćelije i pročišćavanje inertnog dušika opisano je ranije (Višić i Mekjavić, 1989). Dušik je ujedno služio i za miješanje otopine.

Provedba eksperimenta

U radu je korištena metoda kontinuirane potenciometrije. U ćeliju se najprije stavi poznata masa (m_Z) miješanog otapala Z, a zatim u i navrata ($i = 1 - 15$) injektira koncentrirana otopina CdCl₂ (Z) s pomoću "medicinske šprice". Šprica se važe analitičkom vagom (Scaltec, točnosti $\pm 0.0001 \text{ g}$) prije i nakon injektiranja; razlika tih odvaga predstavlja masu koncentrirane otopine dodanu i -tim injektiranjem (m_i) Nakon svakog dodatka otopina se miješa 10 minuta, a zatim mjeri elektromotivnost članka u razmacima od 5 minuta dok se njena vrijednost ne ustali. Molalitet elektrolita nakon i -tog dodatka računa se prema izrazu:

$$b_i = \frac{\sum_i m_i \times w / M}{m_Z + m_i \times (1 - w)} \quad (3)$$

gdje w predstavlja maseni udjel CdCl₂ u koncentriranoj otopini, a M njegovu molarnu masu.

Rezultati i rasprava

Standardna elektromotivnost članka

U Tablici 1 prikazane su izmjerene vrijednosti E članka (1) u 5 % t -butanolu pri raznim molalitetima CdCl_2 i pri svim radnim temperaturama.

Tablica 1. Elektromotivnost (E) članka (1) u 5 mas. % t -butanolu pri raznim temperaturama
Table 1. Electromotivity (E) of cell (1) in 5 mass. % t -butanol at different temperatures

$T = 293.15 \text{ K}$		$T = 298.15 \text{ K}$	
$10^3 b / \text{mol kg}^{-1}$	E / V	$10^3 b / \text{mol kg}^{-1}$	E / V
2.443	0.79256	2.736	0.79070
4.895	0.77171	5.189	0.77148
7.117	0.76107	7.417	0.76138
9.135	0.75415	9.423	0.75477
10.975	0.74920	11.260	0.74998
12.651	0.74538	12.941	0.74628
14.194	0.74230	14.479	0.74328
15.620	0.73975	15.903	0.74098
16.935	0.73773	17.213	0.73898
18.155	0.73595	18.424	0.73727
19.287	0.73445	19.548	0.73575
20.346	0.73311	20.611	0.73447
21.331	0.73194	21.584	0.73334
22.257	0.73089	22.507	0.73234
23.127	0.72995	23.368	0.73144
$T = 303.15 \text{ K}$		$T = 308.15 \text{ K}$	
$10^3 b / \text{mol kg}^{-1}$	E / V	$10^3 b / \text{mol kg}^{-1}$	E / V
2.713	0.79303	2.559	0.79655
5.228	0.77325	4.873	0.77654
7.499	0.76302	7.003	0.76616
9.551	0.75632	8.930	0.75931
11.413	0.75143	10.694	0.75428
13.122	0.74771	12.314	0.75053
14.674	0.74481	13.795	0.74758
16.096	0.74247	15.176	0.74521
17.434	0.74047	16.458	0.74305
18.661	0.73875	17.641	0.74130
19.802	0.73733	18.753	0.73972
20.863	0.73604	19.782	0.73848
21.852	0.73484	20.756	0.73747
22.780	0.73383	21.648	0.73645
23.646	0.73287	22.536	0.73544

Tablica 1. Nastavak
Table 1. Continued

$T = 313.15 \text{ K}$	
$10^3 b / \text{mol kg}^{-1}$	E / V
2.649	0.79706
5.059	0.77716
7.236	0.76661
9.205	0.75977
11.025	0.75472
12.672	0.75086
14.176	0.74783
15.579	0.74523
16.881	0.74304
18.088	0.74116
19.214	0.73957
20.257	0.73817
21.242	0.73693
22.150	0.73582
23.021	0.73483

Vrijednosti opadaju kontinuirano s porastom molalитета CdCl_2 . One su poslužile za računanje E_b° prema metodi koja uzima u obzir sve nastale komplekse (Višić i Mekjavić, 1989), a zasniva se na izrazu:

$$E' = E + \frac{RT}{2F} \ln[(b(\text{Cd}^{2+})/b^\circ)(b(\text{Cl}^-)/b^\circ)^2] - \frac{3RT}{F} \ln(10) A_b (I/b^\circ)^{1/2} / (1 + a_0 B_b (I/b^\circ)^{1/2}) - \frac{3RT}{2F} \ln[1 + M_Z \sum_x b(X)] = E_b^\circ - \frac{3RT}{2F} \ln(10) C I / b^\circ \quad (4)$$

koji je dobiven iz Nernstove jednadžbe za reakciju članka:



U jednadžbi (4) E označava elektromotivnost članka za pojedini molalitet CdCl_2 , $b(\text{Cd}^{2+})$ i $b(\text{Cl}^-)$ su ravnotežni molaliteti kadmijeveog i kloridnog iona, $b^\circ = 1 \text{ mol kg}^{-1}$, A_b i B_b su Debye-Hückelove konstante koje se pri određenoj temperaturi računaju iz eksperimentalno određene gustoće (d) i literaturnih podataka za relativnu permitivnost (ϵ_r) otapala (Åkerlöf, 1932), I označava ionsku jakost otopine, a_0 je parametar ionske veličine i iznosi $0,45 \times 10^{-9} \text{ m}$ (Višić et al., 1993), molarna masa ispitivanog otapala $M_Z = 18,73 \text{ g mol}^{-1}$, $\sum_x b(X)$ predstavlja ravnotežne molalitate svih ionskih vrsta, vrijednost C je empirijski parametar, dok ostale veličine imaju standardno značenje.

Vrijednost E_b° članka (1) može se dobiti ekstrapolacijom E' na nultu ionsku jakost ili metodom najmanjih kvadrata.

Za rješavanje jednadžbe (4) potrebno je odrediti koncentracije svih ionskih vrsta za pojedini molalitet CdCl_2 . Iterativni postupak (Višić i Mekjavić, 1989) započinje tako što se prvo računa početna ionska jakost otopine:

$$I = 3 b d \quad (6)$$

Potom se računaju vrijednosti koncentracijskih konstanti stabilnosti (K'_n) za reakcije (2) prema relaciji:

$$\ln K'_n - \Delta z_n^2 A_c (I/c^{\circ})^{1/2} / (1 + B_c a_0 (I/c^{\circ})^{1/2}) = \ln K_n^{\circ} + (\ln 10) \Delta C_n I / c^{\circ} \quad (7)$$

U jednadžbi (7) ΔC_n je empirijski parametar, $c^{\circ} = 1 \text{ mol dm}^{-3}$ i $\Delta z_n^2 = (2 - n)^2 - n - 4$, gdje z označava naboj pojedine ionske vrste. Vrijednosti ΔC_n i K_n° (termodinamička konstanta stabilnosti) određene su eksperimentalno u vodi (Višić et al., 1993) i 10 % *t*-butanolu (Višić et al., 1999). Iz tih su podataka interpolirane vrijednosti za 5 % *t*-butanol. One su prikazane u Tablici 2 zajedno s nekim svojstvima ispitivanog otapala. Razlog zbog čega ravnotežne konstante nisu posebno mjerene već interpolirane, jest dokazano linearna ovisnost njihovog logaritma o recipročnoj vrijednosti ε_r otapala.

Tablica 2. Parametri jednadžbe (7) u 5 mas. % *t*-butanolu pri raznim temperaturama
Table 2. Parameters of Eq. (7) in 5 mass. % *t*-butanol at different temperatures

T / K	293.15	298.15	303.15	308.15	313.15
K_1°	136	142	147	151	156
K_2°	612	668	733	798	863
K_3°	544	750	855	960	1065
ΔC_1	0.177	0.172	0.170	0.168	0.170
ΔC_2	0.387	0.380	0.368	0.351	0.360
ΔC_3	0.458	0.450	0.420	0.390	0.415
ε_r	76.06	74.26	72.50	70.74	69.02
$d / \text{kg m}^{-3}$	990.14	988.91	987.40	985.63	983.61

Iz vrijednosti konstanti K'_n računaju se ravnotežne koncentracije slobodnih kloridnih iona:

$$K'_3 [\text{Cl}^-]^4 + (K'_3 b d + K'_2) [\text{Cl}^-]^3 + K'_1 [\text{Cl}^-]^2 + (1 - K'_1 b d) [\text{Cl}^-] - 2 b d = 0 \quad (8)$$

slobodnih kadmijevih iona

$$bd = [\text{Cd}^{2+}] + K'_1[\text{Cd}^{2+}][\text{Cl}^-] + K'_2[\text{Cd}^{2+}][\text{Cl}^-]^2 + K'_3[\text{Cd}^{2+}][\text{Cl}^-]^3 \quad (9)$$

te klorokadmijevih kompleksa prema izrazu:

$$K'_n = ([\text{CdCl}_n^{(2-n)+}]/c^\circ) / \{([\text{Cd}^{2+}]/c^\circ)([\text{Cl}^-]/c^\circ)^n\} \quad (10)$$

Iz tako dobivenih početnih koncentracija računa se nova vrijednost ionske jakosti otopine:

$$I = 1/2 (4[\text{Cd}^{2+}] + [\text{Cl}^-] + [\text{CdCl}^+] + [\text{CdCl}_3^-]) \quad (11)$$

i nove, poboljšane vrijednosti K'_n prema izrazu (7). Iteracija se nastavlja dok se vrijednosti konstanti ne stabiliziraju.

Dakle, ravnotežne koncentracije svih ionskih vrsta (pretvorene u molalitet) su korištene u rješavanju jednadžbi (4) metodom najmanjih kvadrata. Rezultirajuća E_b° i njena standardna devijacija ($\sigma(E_b^\circ)$) dana je u Tablici 3, gdje se vidi da ona opada s porastom radne temperature. Standardne devijacije vrijednosti E_b° dobivene kontinuiranom potenciometrijom su u rangu onih za 5 % 2-butanon (Tomaš et al., 2004) i 2-butanol (Tomaš et al., 2005).

Tablica 3. Standardna elektromotivnost članka (1) u 5 mas. % *t*-butanolu pri raznim temperaturama

Table 3. Standard electromotivity of cell (1) in 5 mass. % *t*-butanol at different temperatures

T / K	$E_b^\circ \pm \sigma(E_b^\circ) / \text{V}$
293.15	0.56607 ± 0.00011
298.15	0.56467 ± 0.00016
303.15	0.56268 ± 0.00013
308.15	0.56025 ± 0.00017
313.15	0.55750 ± 0.00012

Usporedbom vrijednosti E_b° pri 298.15 K u ovom radu s onima u vodi (Višić i Mekjavić, 1993) i 10 % *t*-butanolu (Tomaš et al., 2000) uočava se slijedeći odnos: $E_b^\circ(\text{CdCl}_2 \text{ u vodi}) > E_b^\circ(\text{CdCl}_2 \text{ u } 5\% \text{ } t\text{-butanolu}) > E_b^\circ(\text{CdCl}_2 \text{ u } 10\% \text{ } t\text{-butanolu})$, što ukazuje na utjecaj relativne permitivnosti otapala. Naime, smanjenjem relativne permitivnosti otapala s povećanjem sadržaja organske komponente u smjesi rezultira smanjenjem vrijednosti E_b° . To je ustanovljeno i ranije u našim

istraživanjima u smjesama vode i organske komponente (Višić i Mekjavić, 1993 i 1996; Tomaš et al., 2000, 2004 i 2005).

Određivanje E_b° pri raznim temperaturama omogućava izračunavanje temperaturnog koeficijenta standardne elektromotivnosti članka (dE_b°/dT). Temperaturna ovisnost može se prikazati kao polinom drugog reda:

$$E_b^\circ(T) = a + bT + cT^2 \quad (12)$$

gdje su a , b i c konstante polinoma neovisne o temperaturi. Izračunate vrijednosti dane su u Tablici 4.

Tablica 4. Koeficijenti jednadžbe (12) u 5 mas. % *t*-butanolu

Table 4. Coefficients of Eq. (12) in 5 mass. % *t*-butanol

a / V	-0.131 ± 0.059
$10^4 b / V K^{-1}$	50.1 ± 3.9
$10^7 c / V K^{-2}$	-89.7 ± 6.5

Standardne termodinamičke veličine za reakciju članka (5)

Standardni prirast Gibbsove energije ($\Delta_r G^\circ$) računat je iz vrijednosti E_b° prema izrazu:

$$\Delta_r G^\circ = -zFE_b^\circ \quad (13)$$

Standardna prirast entropije ($\Delta_r S^\circ$) dobiven je iz dE_b°/dT :

$$\Delta_r S^\circ = zF(b + 2cT) \quad (14)$$

dok je standardni prirast entalpije ($\Delta_r H^\circ$) dobiven prema izrazu:

$$\Delta_r H^\circ = \Delta_r G^\circ + T \Delta_r S^\circ \quad (15)$$

Standardne termodinamičke veličine za reakciju članka (5) pri 298.15 K prikazane su u Tablici 5. Standardna devijacija vrijednosti $\Delta_r G^\circ$ računata je iz devijacije vrijednosti E_b° . Standardne devijacije vrijednosti $\Delta_r S^\circ$ i $\Delta_r H^\circ$ računata su na slijedeći način:

$$\sigma_{\Delta_r S^\circ} = \sqrt{(2F)^2 \times \sigma_b^2 + (4FT)^2 \times \sigma_c^2} \quad (16)$$

$$\sigma_{\Delta_r H^\circ} = \sqrt{\sigma_{\Delta_r G^\circ}^2 + (T^2 \times \sigma_{\Delta_r S^\circ}^2)} \quad (17)$$

Tablica 5. Standardne termodinamičke veličine za reakciju članka (5) u vodi i 5 mas. % *t*-butanolu pri 298.15 K

Table 5. Standard thermodynamic quantities for the cell reaction (5) in water and 5 mass. % *t*-butanol at 298.15 K

<i>w</i> / %	$\Delta_r G^\circ / \text{kJ mol}^{-1}$	$\Delta_r H^\circ / \text{kJ mol}^{-1}$	$\Delta_r S^\circ / \text{J K}^{-1} \text{mol}^{-1}$
0 ^a	-110.66 ± 0.02	-134 ± 28	-78 ± 93
5	-108.97 ± 0.03	-129 ± 32	-66 ± 106

^aPodaci prema literaturi (Višić i Mekjavić, 1993)

^aValues from literature (Višić and Mekjavić, 1993)

Sve vrijednosti pri 298.15 K su negativnog predznaka što znači da je reakcija spontana, egzotermna i praćena padom entropije. Slično je ustanovljeno i u 5 % 2-butanolu (Tomaš et al., 2005). Usporedbom vrijednosti $\Delta_r G^\circ$ iz ovog rada ($-108,97 \pm 0.03 \text{ kJ mol}^{-1}$) s literaturnom vrijednošću za vodu (Višić i Mekjavić, 1993) ($-110,66 \pm 0.02 \text{ kJ mol}^{-1}$; redeterminirana vrijednost iznosi $-110,83 \pm 0.02 \text{ kJ mol}^{-1}$) vidi se da je reakcija manjeg doseg u miješanom otapalu. Smanjenje doseg reakcije pri istoj temperaturi s porastom sadržaja organske komponente u smjesi, kao i s porastom temperature u istom otapalu (manja vrijednost E_b° pri višoj temperaturi) praćeno je smanjenjem relativne permitivnosti otapala. Smanjenjem relativne permitivnosti jačaju elektrostatske sile među ionima. Zbog toga je potrebno utrošiti više rada da se ioni u otopini drže razdvojeno i $\Delta_r G^\circ$ postaje pozitivniji. Tako u 10 % *t*-butanolu ta vrijednost iznosi $-107,26 \text{ kJ mol}^{-1}$ (Tomaš et al., 2000). Vrijednosti $\Delta_r H^\circ$ i $\Delta_r S^\circ$ su manje negativne u odnosu na one u vodenom mediju (Višić i Mekjavić, 1993).

Srednji stehiometrijski koeficijenti aktiviteta CdCl₂

Srednji stehiometrijski koeficijenti aktiviteta (γ_{\pm}) elektrolita CdCl₂ računati su prema Nernstovoj jednadžbi:

$$E = E_b^\circ - (RT/2F) \ln \{4[(b/b^\circ)\gamma_{\pm}]^3\} \quad (18)$$

za reakciju članka (5) pretpostavljajući da nema stvaranja klorokadmijevih kompleksa.

U Tablici 6. dane su vrijednosti γ_{\pm} za vodeni medij redeterminirane u ovom radu pri 298.15 K metodom kontinuirane potencijometrije i izvršena je usporedba s literaturom.

Tablica 6. Usporedba srednjih molalnih koeficijenta aktiviteta (γ_{\pm}) CdCl₂ u vodi pri 298.15 K prema raznim izvorima

Table 6. Comparison of mean molal activity coefficients (γ_{\pm}) of CdCl₂ in water at 298.15 K from different origins

$b(\text{CdCl}_2) / \text{mol kg}^{-1}$	0.005	0.007	0.010	0.015	0.020
γ_{\pm}^a	0.603	0.553	0.505	0.455	0.423
γ_{\pm}^b	0.623	0.543	0.494	–	0.401
γ_{\pm}^c	0.628	0.569	0.512	0.455	0.418

^aPodaci prema literaturi (Višić i Mekjavić, 1993)

^aData from literature (Višić i Mekjavić, 1993)

^bPodaci prema literaturi (Hefley i Amis, 1965)

^bData from literature (Hefley i Amis, 1965)

^cOvaj rad

^cPresent study

Iz Tablice 6 se vidi da se vrijednosti γ_{\pm} iz ovog rada dobro slažu s onima iz literature (Hefley i Amis, 1965; Višić i Mekjavić, 1993).

Konačno, korištenjem podataka za E i E_b° članka (vidi Tablice 1 i 3) izračunate su vrijednosti γ_{\pm} za 5 % *t*-butanol. Te su vrijednosti za odabrane molalitetu CdCl₂ pri raznim temperaturama prikazane u Tablici 7.

Tablica 7. Srednji molalni koeficijenti aktiviteta (γ_{\pm}) CdCl₂ u 5 mas. % *t*-butanolu pri različitim temperaturama

Table 7. Mean molal activity coefficients (γ_{\pm}) of CdCl₂ in 5 mass. % *t*-butanol at different temperatures

T / K	$b(\text{CdCl}_2) / \text{mol kg}^{-1}$						
	0.003	0.005	0.007	0.009	0.010	0.015	0.020
293.15	0.662	0.570	0.517	0.480	0.466	0.413	0.379
298.15	0.656	0.567	0.514	0.478	0.464	0.411	0.376
303.15	0.651	0.560	0.507	0.471	0.456	0.405	0.372
308.15	0.645	0.554	0.502	0.467	0.452	0.402	0.369
313.15	0.635	0.545	0.494	0.459	0.445	0.395	0.364

Analizom podataka u Tablici 7 vidi se da vrijednosti γ_{\pm} opadaju:

- s porastom molalitetu CdCl₂ pri određenoj temperaturi,
- s porastom temperature pri određenom molalitetu elektrolita.

Takvo ponašanje je u skladu s Debye-Hückelovom teorijom. Slično je ustanovljeno i u 5 % 2-butanonu (Tomaš et al., 2004) i 2-butanolu (Tomaš et al., 2005). Nadalje, vrijednosti γ_{\pm} opadaju sa smanjenjem relativne permitivnosti otapala: $\gamma_{\pm}(\text{voda}) > \gamma_{\pm}(5\% \text{ } t\text{-butanol}) > \gamma_{\pm}(10\% \text{ } t\text{-butanol})$.

Zaključak

Metodom kontinuirane potencijometrije skraćeno je vrijeme potrebno za provedbu eksperimenta, a dobiveni rezultati su pouzdani i usporedivi s literaturnim navodima. Standardna elektromotivnost članka u ispitivanom otapalu opada s porastom temperature. Vrijednost standardnog prirasta Gibbsove energije ukazuje na spontani karakter reakcije članka. Reakcija je egzotermna i pokazuje negativni prirast reakcijske entropije. Trend promjena srednjih stehiometrijskih koeficijenata aktiviteta CdCl_2 u skladu je s Debye-Hückelovom teorijom. Te vrijednosti opadaju s porastom molalитета i temperature i očekivano su niže nego one u vodenom mediju zbog jačeg kompleksiranja.

Literatura

- Åkerlöf, G. (1932): Dielectric constants of some organic solvent–water mixtures at various temperatures, *J. Am. Chem. Soc.* 54 (11), 4125-4139.
- Deyhimi, F., Salamat-Ahangari, R., Ghalami-Tchoobar, B. (2003): Determination of activity coefficients of NH_4Cl in methanol–water mixed solvents at 25°C by electromotive force measurements, *Phys. Chem. Liq.* 41 (6), 605-611.
- Hefley, J. D., Amis, E. S., (1965): Electromotive force studies of cadmium chloride in water, water–ethanol, and ethanol solutions, *J. Phys. Chem.* 69 (6), 2082-2089.
- Hernández-Luis, F., Galleguillos, R. H., Fernández-Mérida, L., González-Díaz, O. (2009): Activity coefficients of NaCl in aqueous mixtures with ϵ -increasing co-solvent: Formamide–water mixtures at 298.15 K, *Fluid Phase Equilib.* 275 (2), 116-126.
- Rui-Fang, C., Man-Cheng, H., Li-Hua, J., Shu-Ni, L., Yu-Cheng, J., Shu-Ping, X. (2007): Activity coefficients of rubidium chloride and cesium chloride in methanol–water mixtures and a comparative study of Pitzer and Pitzer-Simonson-Clegg models (298.15 K), *Fluid Phase Equilib.* 251 (2), 137-144.
- Simeon, V. (2004): Electromotivity to Replace Electromotive Force?, *Chem. Int.* 26 (6), 18.
- Tomaš, R., Višić, M., Mekjavić, I. (2000): Thermodynamics of cadmium chloride in *t*-butanol–water mixtures ($w_{t\text{-BuOH}} = 10\%$, 30% , and 50%) from electromotive force measurements, *Croat. Chem. Acta* 73 (2), 423-433.
- Tomaš, R., Tominić, I., Višić, M., Sokol, V. (2004): Thermodynamics of cadmium chloride in 2-butanone + water mixtures (5, 10, and 15 mass%) from electromotive force measurements, *J. Solution Chem.* 33 (11), 1397-1410.
- Tomaš, R., Tominić, I., Višić, M., Sokol, V. (2005): Thermodynamic study of cadmium chloride in aqueous mixtures of 2-butanol from potential difference measurements, *J. Solution Chem.* 34 (8), 981-992.
- Višić, M., Mekjavić, I. (1989): Thermodynamics of the cell: $\text{Cd(s)} + \text{Hg} | \text{CdCl}_2(\text{aq}, m) | \text{AgCl} | \text{Ag}$, *J. Chem. Thermodynamics* 21 (2), 139-145.
- Višić, M., Mekjavić, I. (1993): Thermodynamics of the cell: $\text{Cd(Hg)}_{\text{satd.}} | \text{CdCl}_2(m) | \text{AgCl} | \text{Ag}$ in (10, 30 and 50 Mass per Cent) 2-Propanol–Water Mixtures, *Croat. Chem. Acta* 66 (3-4), 479-488.

- Višić, M., Jadrić, A., Mekjavić, I. (1993): The stability constants of cadmium chloride complexes in 2-propanol–water mixtures (0, 10, 30 and 50 mass per cent) from electromotive force measurements, *Croat. Chem. Acta* 66 (3-4), 489-498.
- Višić, M., Mekjavić, I. (1996): Thermodynamics of the cell: Cd(Hg)(l,satd.)|CdCl₂(m)|AgCl|Ag in (10, 30 and 50 mass per cent) acetone–water mixtures, *Croat. Chem. Acta* 69 (1), 27-36.
- Višić, M., Tomaš, R., Mekjavić, I. (1999): Stability constants of chlorocadmium complexes in *t*-butanol + water mixtures ($w_{t\text{-BuOH}} = 10\%$, 30% , and 50%) from electromotive force measurements, *Croat. Chem. Acta* 72 (1), 55-70.
- Zhang, L., Lu, X., Wang, Y., Shi, J. (1993): Determination of activity coefficients using a flow emf method. 1. HCl in methanol–water mixtures at 25, 35 and 45 °C, *J. Solution Chem.* 22 (2), 137-150.

Thermodynamic properties of CdCl₂ in *tert.* butanol (5 mass. %) + water mixture

R. Tomaš, V. Sokol, P. Bošković

University of Split, Faculty of Chemistry and Technology, Teslina 10/V, 21000 Split, Croatia

Summary

The electromotivity of a galvanic cell without liquid junction:

$\text{Cd(Hg) (l, satd.)} | \text{CdCl}_2(b), t\text{-butanol (5 mass.\%)} + \text{water} | \text{AgCl(s)} | \text{Ag(s)}$,
molality (b) being increased by continuous addition of concentrated electrolyte solution, was measured in the temperature range (293.15 K – 313.15 K) at 5 K intervals. The measured values were processed in order to obtain the standard molal electromotivity (E_b°) of the cell for each temperature by means of a method that takes into account the chlorocadmium complex formation reactions; their equilibrium constants were not measured but obtained by interpolation into the literature data. The E_b° values were used to calculate the standard thermodynamic quantities for the cell reaction and the stoichiometric mean molal activity coefficients of CdCl₂. The thermodynamic values obtained have been compared with those in similar systems.

Keywords: cadmium chloride, *tert.* butanol + water mixture, potentiometry, thermodynamic quantities

Glucosinolate hydrolysis products from brassicaceae plants

UDC: 577.152.3 : 582.683.2

M. Zekić*, A. Radonić, I. Blažević, J. Mastelić, S. Bilić

University of Split, Faculty of Chemistry and Technology, Department of Organic Chemistry, Teslina 10/V, 21000 Split, Croatia

Summary

Three wild-growing Brassicaceae plants, *Aurinia leucadea*, *Cardaria draba* and *Capsella rubella*, were investigated to uncover glucosinolates using indirect method consisting of either non-enzymatic (thermal degradation) or enzymatic (with exogenous myrosinase) hydrolysis followed by GC-MS analysis of volatile hydrolysis products. The identification of volatile hydrolysis products isolated from *Aurinia leucadea* revealed the presence of three glucosinolates, namely gluconapin, glucobrassicinapin and glucoberteroin. Gluconapin and glucobrassicinapin were the main glucosinolates regardless of the hydrolysis method. *Capsella rubella* contained five glucosinolates, with sinigrin, 10-(methylthio)decyl glucosinolate and 9-(methylthio)nonyl glucosinolate identified only in sample obtained by thermal degradation, and glucoarabin and glucocamelinin identified only after exogenous myrosinase hydrolysis. Glucoerucin was the major glucosinolate obtained by non-enzymatic hydrolysis of *Cardaria draba*, while the sample obtained after enzymatic hydrolysis contained five glucosinolates: glucoraphanin (the most abundant compound), glucosinalbin, glucoerysolin, glucoerucin and gluconapin.

Keywords: glucosinolates, *Aurinia leucadea*, *Cardaria draba*, *Capsella rubella*, non-enzymatic and enzymatic hydrolysis

Introduction

The present paper represents the continuation of our research of glucosinolate degradation products and, indirectly, glucosinolates from Croatian wild-growing Brassicaceae plants (Mastelić et al., 2006; Blažević and Mastelić, 2008a, 2008b; Blažević et al., 2010a, 2010b). Glucosinolates are group of phytochemicals present exclusively in 16 botanical families of the order Capparales, and particularly abundant in Brassicaceae (Fahey et al., 2001). They are interesting as a source of volatile degradation products possessing various biological activities: fungicidal, bacterocidal, nematocidal, allelopathic and anticancer properties. These volatile compounds, primarily isothiocyanates and nitriles, can be obtained either enzymatically with myrosinase or non-enzymatically. Literature data about glucosinolate degradation products from three investigated Brassicaceae plants are rather limited.

* zekic@ktf-split.hr

Aurinia leucadea (Guss.) K. Koch (synonym *Alyssum leucadeum* Guss.) is an endemic flowering plant of Croatian Adriatic coast belonging to the genus *Aurinia*. As far as we know, there is no report on glucosinolate degradation products or glucosinolates of *A. leucadea*. In review article, Fahey et al. (2001) listed glucosinolates identified in the plants belonging to *Aurinia* genus: glucoalyssin, glucoiberin, glucoerucin, glucoberberoin, glucojiabutin, gluconapin and glucobrassicinapin. In our previous work (Blažević et al., 2010) three glucosinolates, namely glucoberberoin, glucobrassicinapin and glucoalyssin, were identified in *Aurinia sinuata* of Croatian origin.

Capsella rubella Reut. (synonym *Capsella rubescens* Pers.) is closely related and often replaced by mistake with *C. bursa-pastoris*. Same as *C. bursa-pastoris*, it is spread all over Europe. Likewise, Fahey et al. (2001) listed glucosinolates identified in two plant species belonging to genus *Capsella*, but, as far as we know, there is no report on glucosinolate degradation products or glucosinolates of *Capsella rubella* Reut.

Cardaria draba (L.) Desv. (synonym *Lepidium draba* L.) is invasive weed native to Europe and now disseminating throughout the world. The presence of different glucosinolates (glucoraphanin, glucoerysolin, glucoerucin, etc.) in *C. draba* has been reported in review article by Fahey et al. (2001). Recently, Afsharypuor and Jamali (2006) identified 3-butenyl isothiocyanate and sulforaphane as the main degradation products of the flowering aerial parts of Iranian *C. draba*.

The aim of this study was to identify the glucosinolate in three wild-growing Brassicaceae plants, *Aurinia leucadea*, *Cardaria draba* and *Capsella rubella*, using indirect method consisting of either non-enzymatic (thermal degradation) or enzymatic (with exogenous myrosinase) hydrolysis followed by GC-MS analysis of volatile degradation products.

Materials and methods

Reagents

All the solvents employed were purchased from Fluka Chemie, Buchs, Switzerland. Anhydrous sodium sulphate was obtained from Kemika, Zagreb, Croatia. Thioglucosidase (myrosinase; 361 U/g) from *Sinapis alba* seed was purchased from Sigma-Aldrich Chemie GmbH, Steinheim, Germany.

Plant Material

Plants were collected near Split (Dalmatia, Mediterranean region of Croatia) during flowering in spring 2010 from wild-growing populations. Aerial parts of the plants (flowers and leaves with green siliques) were used. The botanical identity of the plant material was confirmed by a local botanist and the voucher

specimens are deposited at Department of Organic Chemistry, Faculty of Chemistry and Technology, Split, Croatia.

Non-enzymatic hydrolysis

Plant material (200 g) was subjected to hydrodistillation in Clevenger type apparatus for 3 h using pentane : ether 1:1 (v/v) for trapping (Blažević and Mastelić, 2008a). After distillation, the pentane: ether extract was separated and dried over anhydrous sodium sulphate. The extract was concentrated by carefully evaporation of the solvent mixture to a small volume (*cca.* 3 ml), and 1 µl of this solution was used for GC-MS analyses.

Enzymatic hydrolysis

Plant material (400 ml) was chopped, put in boiled water and boiled for 5 minutes in order to inactivate plant enzymes and extract present glucosinolates. Water extract was left to cool to room temperature, exogenous myrosinase (10 mg) was added and allowed to hydrolyze for 24 h in order to liberate volatile aglucones. Water solution was extracted with dichloromethane (3 x 100 ml), dichloromethane extract was separated from the water layer by centrifugation at 3500 rpm. Dichloromethane extracts were joined, dried over anhydrous sodium sulphate, concentrated to 10 ml in a rotary evaporator and thereafter by careful fractional distillation to a final volume (*cca.* 1 ml), of which 1 µl was used for GC-MS analyses (Al-Gendy et al., 2010).

Gas chromatography-mass spectrometry (GC-MS)

Analyses were performed on an Agilent Technologies GC-MS system (GC model 7890 A with a mass selective detector model 5975 C) using HP-5 capillary column (5 % diphenyl- and 95 % dimethylpolysiloxane; 30 m × 0.25 mm i.d., film thickness 0.20 µm). GC operating conditions was programmed from 70 °C isothermal for 3.5 min, then to 200 °C at a rate of 3 °C/min and held isothermal for 20 min. Carrier gas was helium with flow rate 1ml/min, injector temperature 250 °C, volume injected 1µl, split ratio 1:50. MS conditions: ionization voltage 70 eV, ion source temperature 280 °C, mass range 35-350 mass units.

Identification and quantitative determination of components

Individual peaks were identified by comparing their retention indices (RI) and mass spectra (MS) with those from our homemade library (Blažević and Mastelić, 2008), as well as by computer matching against the Wiley 275 library spectra database and comparison of the mass spectra with the literature data (Adams, 1995; Vaughn and Berhow, 2005).

Results and Discussion

Glucosinolate breakdown products, depending on the substrate, pH value, availability of Fe^{2+} ions and presence and activity of epithiospecifier protein, include isothiocyanates, nitriles, epithionitriles, thiocyanates, oxazolidine-2-thiones and epithioalkanes (Fig. 1). The main degradation products are isothiocyanates at physiological pH, and nitriles that are formed at $\text{pH} < 4$ (Halkier, 1999).

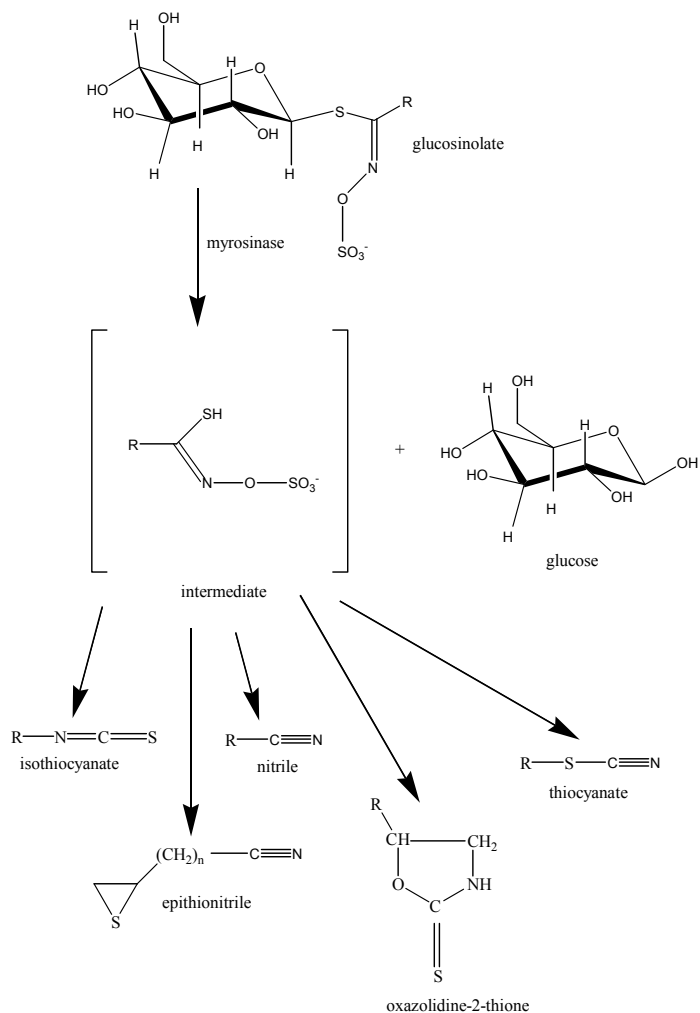

Fig. 1. General scheme of glucosinolate degradation

Isolation of glucosinolate degradation products was performed by two methods: hydrodistillation and dichloromethane extraction upon exogenous myrosinase

hydrolysis. During hydrodistillation, performed in Clevenger type apparatus, high temperature (100 °C) causes thermal degradation of glucosinolates and liberation of volatile degradation products (Bones and Rositer, 2006; Fahey et al., 2001). Hydrodistillation insures simultaneous glucosinolate degradation, isolation and concentration of liberated volatile compounds. Some volatile and water-soluble glucosinolate degradation products cannot be isolated by hydrodistillation or are thermolabile and subsequent degrade into other volatiles. Therefore, after hydrolysis of the plant material by exogenous myrosinase, liberated compounds were extracted with dichlormethane. Using different isolation methods, hydrodistillation and extraction upon myrosinase hydrolysis, allows conclusions about glucosinolates present in plant materials.

Aurinia leucadea

Table 1 lists glucosinolates tentatively identified in the plant material of *A. leucadea* from their degradation products. Main glucosinolate degradation products, regardless of the degradation mode, originate from gluconapin, glucobrassicinapin and glucuberteroin. On the contrary to the previous reported glucosinolates in *A. sinuata* (Blažević et. al., 2010a), glucoalyssin wasn't identified in *A. leucadea*. Quantitively important compounds identified in the sample obtained by hydrodistillation, i.e. non-enzymatically, were 3-butenyl isothiocyanate (27.9 %), 4-pentenyl isothiocyanate (20.7 %) and 4-pentenitrile (12.8 %), thus this sample has isothiocyanate character. On the other hand, the major compounds isolated by dichlormethane extraction upon enzymatic hydrolysis were 4,5-epithiopentanenitrile (39.6 %) and 5,6-epithioheksanenitrile (18.8 %), therefore this sample has nitrile character.

Table 1. Glucosinolate degradation products of *Aurinia leucadea* (Guss.) K. Koch

glucosinolate	glucosinolate degradation products and their peak areas (%)	
	enzymatic hydrolysis	non-enzymatic hydrolysis
gluconapin	3-butenyl ITC (7.3) 4-pentenitrile (2.8) 4,5-epithiopentanenitrile (39.6)	3-butenyl ITC (27.9) 4-pentenitrile (12.8) 4,5-epithiopentanenitrile (1.4)
glucobrassicinapin	5,6-epithiohexanenitrile (18.8) 4-pentenyl ITC (9.6) 5-hexenenitrile (4.2)	5,6-epithiohexanenitrile (0.9) 4-pentenyl ITC (20.7) 5-hexenenitrile (8.2)
glucuberteroin	5-(methylthio)pentyl ITC (1.3) 6-(methylthio)heksanenitrile (0.5)	5-(methylthio)pentyl ITC (1.7) 6-(methylthio)heksanenitrile (1.0)
<i>sec</i> -butyl GLS	<i>sec</i> -butyl ITC (0.5)	<i>sec</i> -butyl ITC (0.5)
glucoerucin	/	4-(methylthio)butyl ITC (0.6)
glucotropaeolin	/	benzyl ITC (0.6)

Abbreviations: GLS - glucosinolate; ITC – isothiocyanate / - not identified

Capsella rubella

Glucosinolate degradation products of both samples are given in Table 2. In the sample of volatile compounds obtained by extraction after enzymatic hydrolysis only two glucosinolate hydrolysis products were identified, 9-(methylsulfinyl)nonyl isothiocyanate (arabin; 22.7 %) and 10-(methylsulfinyl)decyl isothiocyanate (camelinin; 8.2 %), thus this sample has isothiocyanate character. These isothiocyanates originate from glucosinolates with trivial names glucoarabin and glucocamelinin. Vaughn and Berhow (2005) reported the same unusual glucosinolates in *Capsella bursa-pastoris*, species belonging to the same genus as *C. rubella*. Among the volatiles isolated from *C. rubella* by hydrodistillation, the most abundant was allyl isothiocyanate (21.3 %), degradation product of sinigrin. Other quantitatively important compounds originated from glucosinolate thermal degradation were 11-(methylthio)undecanenitrile (8.2 %) and 10-(methylthio)decanenitrile (8.0 %). So, this sample has mixed isothiocyanate-nitrile character. Thus, in addition to sinigrin two more glucosinolates, 9-(methylthio)nonyl glucosinolate and 10-(methylthio)decyl glucosinolate, were tentatively identified in this sample.

Table 2. Glucosinolate degradation products of *Capsella rubella* Reut

glucosinolate	glucosinolate degradation products and their peak areas (%)	
	enzymatic hydrolysis	non-enzymatic hydrolysis
sinigrin	/	allyl ITC (21.3)
glucoarabin	9-(methylsulfinyl)nonyl ITC (22.7)	/
glucocamelinin	10-(methylsulfinyl)decyl ITC (8.2)	/
9-(methylthio)nonyl GLS	/	9-(methylthio)nonyl ITC (2.8) 10-(methylthio)decanenitrile (8.0)
10-(methylthio)decyl GLS	/	10-(methylthio)decyl ITC (1.1) 11-(methylthio)undecanenitrile (8.2)

Abbreviations: GLS - glucosinolate; ITC – isothiocyanate / - not identified

Cardaria draba

Glucosinolate degradation products isolated from *Cardaria draba* by hydrodistillation and extraction upon enzymatic hydrolysis are shown in Table 3. The major glucosinolate degradation products originated from glucoerucin in the sample obtained by thermal degradation, while, according to the quantity of degradation products, glucoraphanin was the main glucosinolate in the sample obtained enzymatically. Glucoraphanin, *i.e.* its degradation products, was not identified in the sample obtained non-enzymatically. The probable cause is the thermolability of sulforaphane and its subsequent degradation into other volatiles (Yin et al., 1999). As quantitatively the most important compounds found in hydrodistillate were 4-(methylthio)butyl isothiocyanate (28.0 %), followed by 5-(methylthio)pentanenitrile (13.8 %), this sample has mixed

isothiocyanate-nitrile character. Major compound identified after myrosinase hydrolysis was 4-(methylsulfinyl)butyl isothiocyanate (69.2 %), known as sulforaphane, thus this sample has isothiocyanate character. Other volatile degradation products of glucosinolates were identified in much smaller amounts in both samples. 3-Butenyl isothiocyanate, identified as the main volatile compound in Iranian *C. draba* (Afsharypuor and Jamali, 2006), was identified in our *C. draba* too, but in small amount and only among volatiles obtained by enzymatic hydrolysis.

Table 3. Glucosinolate degradation products of *Cardaria draba* (L.) Desv.

glucosinolate	glucosinolate degradation products and their peak areas (%)	
	enzymatic hydrolysis	non-enzymatic hydrolysis
glucoerucin	5-(methylthio)pentanenitrile (0.7) 4-(methylthio)butyl ITC (2.3)	5-(methylthio)pentanenitrile (13.8) 4-(methylthio)butyl ITC (28.0)
glucoraphanin	5-(methylsulfinyl)pentanenitrile (4.5) 4-(methylsulfinyl)butyl ITC (69.2)	/
glucosinalbin	4-hydroxyphenylacetone nitrile (7.2)	/
glucoerysolin	4-(methylsulfonyl)butyl ITC (5.0)	/
glucoberteroin	/	6-(methylthio)heksanenitrile (0.1) 5-(methylthio)pentyl ITC (0.1)
gluconapin	3-butenyl ITC (2.0)	/
glucotropaeolin	/	benzyl ITC (0.1)
<i>sec</i> -butyl GLS	/	<i>sec</i> -butyl ITC (0.1)
<i>iso</i> -butyl GLS	<i>iso</i> -butyl ITC (0.2)	<i>iso</i> -butyl ITC (0.3)

Abbreviations: GLS - glucosinolate; ITC – isothiocyanate / - not identified

Conclusions

Different approaches to the glucosinolate degradation and isolation of liberated volatile products applied on different Brassicaceae plants, that is *Aurinia leucadea*, *Cardaria draba* and *Capsella rubella*, ensures better conclusion about glucosinolates present in these plants.

This work includes the identification of the glucosinolates in *Aurinia leucadea* (Guss.) K. Koch (synonym *Alyssum leucadeum* Guss.) and *Capsella rubella* Reut. (synonym *Capsella rubescens* Pers.), which, to our knowledge, have not been published previously. Also, as far as we know, this is the first report of the glucosinolates in *Cardaria draba* (L.) Desv. (synonym *Lepidium draba* L.) growing along Croatian Adriatic coast.

References

- Adams, R. P. (1995): Identification of Essential Oil Components by Gas Chromatography/Mass Spectroscopy, Carol Stream USA: Allured Publishing.
 Afsharypuor, S., Jamali, M. (2006): Volatile constituents of the flowering aerial parts, fruits and roots of *Cardaria draba* L., *J. Essent. Oil Res.* 18 (6), 674-675.

- Al-Gendy, A. A., El-gindi, O. D., Hafez, A. S., Ateya, A. M. (2010): Glucosinolates volatile constituents and biological activities of *Erysimum corinthium* Boiss. (Brassicaceae), *Food Chem.* 118 (3), 519-524.
- Blažević, I., Mastelić, J. (2008a): Free and bound volatiles of rocket (*Eruca sativa* Mill.), *Flav. Fragr. J.* 23 (4), 278-285.
- Blažević, I., Mastelić, J. (2008b): Free and bound volatiles of garlic mustard (*Alliaria petiolata*), *Croat. Chem. Acta* 81 (4), 607-613.
- Blažević, I., Radonić, A., Mastelić, J., Zekić, M., Skočibušić, M., Maravić, A. (2010a): Glucosinolates, glycosidically bound volatiles and antimicrobial activity of *Aurinia sinuata* (Brassicaceae), *Food chem.* 121 (4), 1020-1028.
- Blažević, I., Radonić, A., Mastelić, J., Zekić, M., Skočibušić, M., Maravić, A. (2010b): Hedge mustard (*Sisymbrium officinale*): chemical diversity of volatiles and their antimicrobial activity, *Chem. Biodivers.* 7 (8), 2023- 2034.
- Bones, A. M., Rossiter, J. T. (2006): The enzymic and chemically induced decomposition of glucosinolates, *Phytochemistry* 67 (11), 1053-1067.
- Fahey, J. W., Zalcmann, A. T., Talalay, P. (2001): The chemical diversity and distribution of glucosinolates and isothiocyanates among plants, *Phytochemistry* 56 (1), 5-51.
- Halkier, B. A. (1999): Glucosinolates. In: Naturally Occurring Glycosides, Ikan, R. (ed.), Chichester, England: John Wiley and Sons, 210-212.
- Mastelić, J., Blažević, I., Jerković, I. (2006): Free and bound sulphur containing and other volatile compounds from evergreen candytuft (*Iberis sempervirens* L.), *Croat. Chem. Acta* 79 (4), 591-597.
- Vaughn, S. F., Berhow, M. A. (2005): Glucosinolate hydrolysis products from various plant sources: pH effects, isolation and purification, *Ind. Crop. Prod.* 21 (2), 193-202.

Kontinuirano mjerenje koncentracije dinatrijevog tetraborat dekahidrata tijekom procesa šaržne kristalizacije hlađenjem

UDC: 661.652 : 66.065.5

M. Akrap, D. Bralić, N. Kuzmanic*

Sveučilište u Splitu, Kemijsko-tehnološki fakultet, Teslina 10/V, 21000 Split, Hrvatska

Sažetak

Podaci o koncentraciji matične otopine predstavljaju bitan parametar za kontrolu i procjenu mehanizma kristalizacijskog procesa. Cilj rada bio je razviti metodu pogodnu za kontinuirano mjerenje koncentracije kristalizirajuće soli tijekom procesa šaržne kristalizacije dinatrijevog tetraborat dekahidrata postupkom kontroliranog hlađenja. Iz navedenog razloga ispitana je mogućnost primjene potenciometrijske metode tj. natrijeve ion-selektivne elektrode. Kako ion-selektivna elektroda ne daje direktno vrijednost koncentracije otopine, njeno korištenje zahtjeva primjenu baždarnog postupka. Naime, tijekom šaržne kristalizacije hlađenjem temperatura matične otopine se kontinuirano mijenja što zahtijeva određene modifikacije baždarnog postupka. Te modifikacije svode se na definiranje funkcionalne ovisnosti elektrodnog potencijala o koncentraciji i temperaturi matične otopine. Utvrđeno je da se baždarenje elektrode mora izvršiti pri istim procesnim uvjetima pri kojima će se potom provoditi i kristalizacija hidratiziranog dinatrijevog tetraborata. Tu se prvenstveno misli na brzinu hlađenja i volumen matične otopine. U daljnjem dijelu rada potenciometrijska metoda primijenjena je za kontinuirano praćenje promjena koncentracije, odnosno prezasićenosti matične otopine tijekom kristalizacijskog procesa koji se provodio pri različitim uvjetima miješanja. Promjene navedenih veličina prikazane su u ovisnosti o načinu provedbe procesa te su detaljno analizirane. U cilju provjere točnosti potenciometrijske metode koncentracija matične otopine određivana je i volumetrijskom metodom. Utvrđeno je vrlo dobro slaganje primijenjenih metoda.

Ključne riječi: dinatrijev tetraborat dekahidrat, šaržna kristalizacija, ion-selektivna elektroda, apsolutna prezasićenost

Uvod

Kristalizacija dinatrijevog tetraborat dekahidrata (boraksa) započinje u prezasićenoj matičnoj otopini nukleacijom, a nastavlja se rastom nastalih nukleusa, odnosno kristala. Kao posljedica izdvajanja čvrste faze u matičnoj otopini se odvijaju znatne koncentracijske promjene. Te promjene moguće je izraziti pomoću apsolutne prezasićenosti, Δc , koja u biti predstavlja pokretačku silu procesa kristalizacije. Apsolutna prezasićenost se izražava kao razlika

*kuzmanic@ktf-split.hr

koncentracije soli u prezasićenoj matičnoj otopini, c , i koncentracije soli koja odgovara ravnotežnoj topljivosti pri istoj temperaturi, c^* (Mullin, 2001; Myerson, 2002). Utvrđeno je da način promjene prezasićenosti matične otopine tijekom procesa kristalizacije značajno utječe na karakteristike finalnog produkta (Jagadeshi et al., 1996; Srinivasakannan et al., 2002; Ulrich and Strege, 2002; Lewiner et al. 2002). Iz navedenog razloga brojni autori su sagledavali mogućnost primjene različitih analitičkih metoda koje bi omogućile pouzdano mjerenje koncentracije matične otopine u procesnom vremenu (Genceli et al., 2005; Wang et al., 2000).

U ovom radu ispitana je mogućnost kontinuiranog mjerenja koncentracije dinatrijevog tetraborat dekahidrata tijekom njegove kristalizacije uporabom potenciometrijske metode. Dobiveni podaci omogućili bi potpuniji uvid i kontrolu procesa nukleacije i rasta kristala s ciljem dobivanja produkta željenih karakteristika. Ispitivana metoda se temeljila na mjerenju razlike potencijala između polimerne natrijeve ion-selektivne elektrode i referentne elektrode. Primjenu natrijeve ion-selektivne elektrode pri određivanju koncentracije ove soli omogućila je činjenica da su kao produkti reakcije otapanja u otopini prisutni i natrijevi ioni. Otapanje ove soli može se prikazati na sljedeći način (www.chem.gmu.edu):

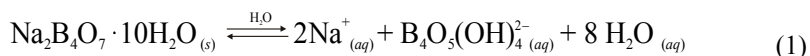

Potenciometrijska metoda omogućuje određivanje množinske koncentracije natrijevih iona, dok se koncentracija dinatrijevog tetraborat dekahidrata izračunava iz stehiometrijskog odnosa.

Poznato je da su ion-selektivne elektrode (*ISE*) osjetne naprave čiji potencijal ovisi o aktivitetu samo jedne molekulske vrste prisutne u otopini (Piljac, 1995; Skoog et al., 1999). Sadrže osjetljivu elektrokemijsku membranu koja odvaja ispitivanu otopinu od unutrašnje referentne otopine. Vrlo važno svojstvo tih membrana je formiranje razlike potencijala između dviju otopina. Kada se elektroda uroni u ispitivanu otopinu trenutno se uspostavi tok iona unutar membrane u smjeru otopine koja ima niži aktivitet iona. Prijenos iona rezultira razlikom potencijala. Ako se pretpostavi da je aktivitet iona u unutrašnjoj referentnoj otopini konstantan, ravnotežni potencijal ovisi o aktivitetu ispitivanog iona u otopini i definiran je Nernstovim izrazom:

$$E = E^0 + \frac{2.303RT}{zF} \log a \quad (2)$$

ISE su široko prihvaćene prvenstveno zbog svoje jednostavnosti, relativno su jeftine, a u odnosu na druge tehnike umnogome skraćuju vrijeme analize. Danas se te elektrode mogu koristiti u širokom koncentracijskom području od 10^{-1} do 10^{-6} mol dm^{-3} . Velika njihova prednost je u brzom odzivu i kod najmanje promjene koncentracije ispitivane otopine.

Materijali i metode

Kristalizacija dinatrijevog tetraborat dekahidrata, kao i baždarenje natrijeve ion-selektivne elektrode se provodilo u aparaturi prikazanoj na Slici 1. Osnovni dio aparature predstavlja kristalizator smješten u termostatskoj kupelji. S unutarnje strane stijenke kristalizatora nalazila su se četiri razbijala virova standardnih dimenzija ($B = D/10$) postavljena pod kutom od 90° u odnosu na stijenku. Razbijala virova u neposrednoj blizini dna posude bila su izvedena pod kutom od 45° , čime se nastojalo pospješiti cirkulaciju kapljevine u posudi tj. spriječiti stvaranje tzv. "mrtvih zona". Brzina vrtnje miješala, kao i kontinuirano praćenje utroška snage miješanja tijekom kristalizacije provodilo se miješalicom *Lightnin Labmaster*.

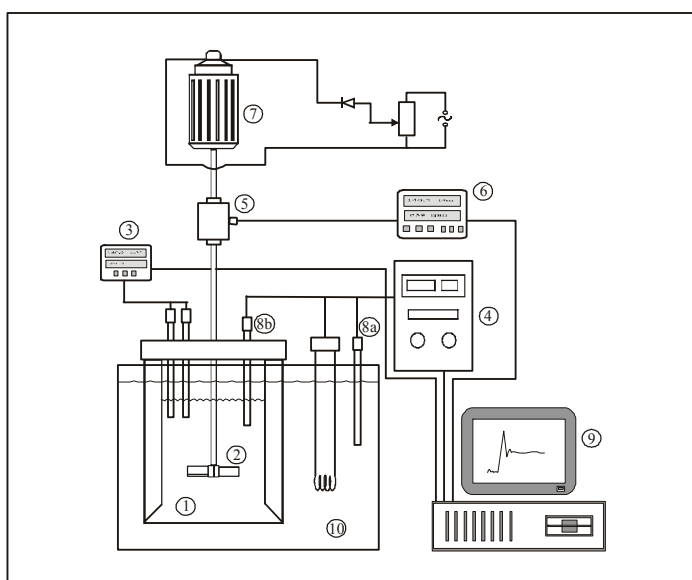

(1. Crystallizer, 2. Impeller, 3. System for concentration measurement,
4. Thermostat, 5. Torquemeter, 6. Torque sensor and velocity transducer,
7. Variable speed motor, 8.a.b Temperature probes, 9. Computer,
10. Thermostatic bath)

Slika 1. Aparatura za izvođenje eksperimenta
Fig. 1. Experimental set-up

Brzina hlađenja i kontinuirano mjerenje temperature u kristalizatoru regulirano je programibilnim termostatom tipa *Huber CC3* s točnošću od ± 0.01 °C. Sustav za mjerenje koncentracije sastojao se od polimerne natrijeve ion-selektivne elektrode u kombinaciji s referentnom elektrodom spojenih na milivoltmetar *Metrohm*. Kao referentna elektroda korištena je *Ag/AgCl* elektroda s otopinom kalijevog klorida koncentracije 3 mol dm^{-3} .

Rezultati i rasprava

Budući da ion-selektivna elektroda ne daje direktno vrijednost koncentracije otopine, već pokazuje potencijal ovisan o aktivitetu ispitivanog iona, njezina primjena zahtjeva izradu baždarnе krivulje. Općenito, ta krivulja predstavlja odnos potencijala ion-selektivne elektrode i aktiviteta određivanog iona pri konstantnoj temperaturi. Međutim, kako se tijekom šaržne kristalizacije *ISE* koristi u promjenjivim temperaturnim uvjetima, njeno baždarenje je potrebno izvršiti tako da se u odnos dovedu potencijal natrijeve ion-selektivne elektrode s koncentracijom i temperaturom otopine.

U prvom dijelu rada izvršeno je baždarenje natrijeve ion-selektivne elektrode pri brzini hlađenja i volumenu matične otopine istovjetnim onima pri kojima će se potom provoditi i kristalizacija boraksa. Volumen otopine mora biti isti kako bi brzina prijenosa topline unutar standardne otopine bila istovjetna onoj u matičnoj otopini tijekom kristalizacijskog procesa.

Standardne otopine za provedbu postupka baždarenje *ISE* pripremljene su otapanjem soli dinatrijevog tetraborata dekahidrata analitičke čistoće (p.a.) u ultračistoj vodi ($\kappa = 0.054 \mu\text{S cm}^{-1}$). Volumen pripremljenih otopina iznosio je 2 dm^3 , a koncentracije soli, kao i Na^+ iona u tim otopinama prikazane su u Tablici 1.

Tablica 1. Koncentracije standardnih otopina boraksa

Table 1. Concentration of standard solutions of borax decahydrate

Br. otopine (No. solution)	1	2	3	4	5	6	7
$c_{\text{sol}} \text{ (mol dm}^{-3}\text{)}$	0.050	0.080	0.100	0.120	0.150	0.180	0.187
$c_{\text{Na}^+} \text{ (mol dm}^{-3}\text{)}$	0.100	0.160	0.200	0.240	0.300	0.360	0.374

Brzina hlađenja pripremljenih otopina iznosila je $6 \text{ }^\circ\text{C h}^{-1}$, dok su se ispitivanja provodila u temperaturnom radnom području od 30 do $5 \text{ }^\circ\text{C}$. Otopine su miješane turbinskim miješalom brzinom vrtnje od 300 o. min^{-1} . Vrijednosti potencijala ion-selektivne elektrode i temperature matične otopine kontinuirano su zapisivane u računalnoj bazi podataka. Na Slici 2 prikazana je promjena potencijala ion-selektivne elektrode s temperaturom u otopinama poznatih koncentracija, pri linearnoj brzini hlađenja otopine od $6 \text{ }^\circ\text{C h}^{-1}$. Iz Slike 2 je uočljivo da se pri konstantnoj brzini hlađenja potencijal ion-selektivne elektrode linearno smanjuje sa sniženjem temperature u svim ispitivanim otopinama. Dobiveni pravci gotovo su paralelni s tim što elektrodni potencijal ima veću vrijednost u otopinama većih koncentracija. Pravci dobiveni za takve otopine ograničeni su na uže temperaturno područje. Naime, u koncentriranijim otopinama sniženjem temperature dolazi do pojave nukleacije, a time i do smanjenja početne koncentracije otopine. U tom slučaju koncentracija otopine

više nije poznata i ne može biti mjerodavna za postupak baždarenja. Korištenjem dijagrama $E - T$ prikazanih na Slici 2 izradene su baždarne krivulje $E - \log c$ za sve cjelobrojne vrijednosti temperatura u području od 5 do 30 °C. Na Slici 3 prikazani su samo primjeri nekih od dobivenih baždarnih krivulja.

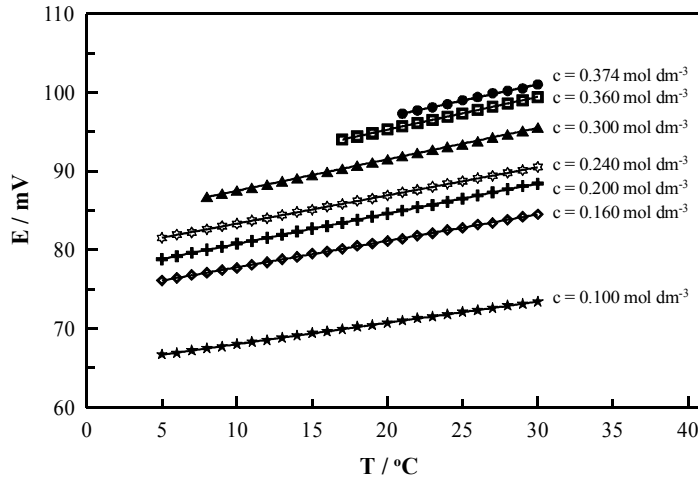

Slika 2. Promjena potencijala ion-selektivne elektrode s temperaturom u otopinama poznatih koncentracija Na^+ iona

Fig. 2. Change of ion-selective electrode potential with temperature in the solutions of known concentrations of Na^+ ions

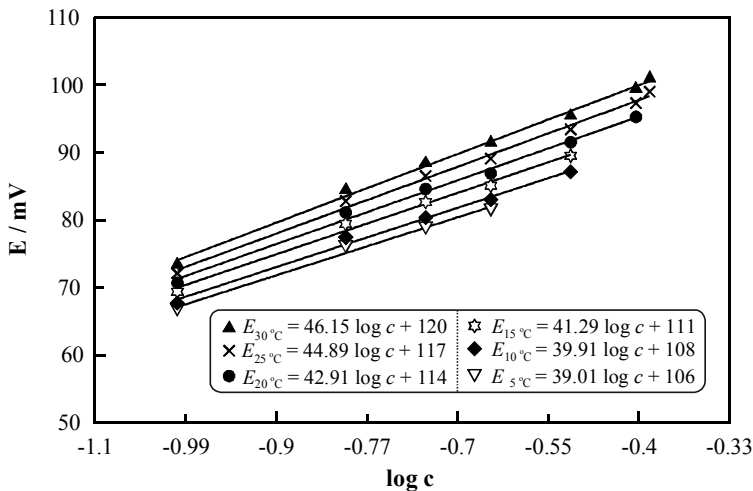

Slika 3. Primjeri baždarnih krivulja natrijeve ion-selektivne elektrode za različite temperature otopine

Fig. 3. Examples of calibration curves of ion-selective electrode for the different solution temperatures

Koeficijenti determinacije za dobivene pravce iznosili su od 0.980 do 0.999. Kako su dobivene baždarnne krivulje linearne, a što je u skladu s Nernstovom jednadžbom, može se zaključiti da se ispitivano područje koncentracija nalazi unutar mjernog područja primijenjene ion-selektivne elektrode.

Dobiveni baždarni pravci mogu poslužiti za određivanje koncentracije boraksa tijekom procesa šaržne kristalizacije hlađenjem. Međutim, kako se uslijed kontinuiranog hlađenja temperatura matične otopine neprestano mijenja, određivanje koncentracije zahtijeva učestalije promjene baždarnih krivulja. Iz navedenog razloga očitavanje se pojednostavljuje izradom tzv. baždarnne tablice čiji je dio prikazan u Tablici 2. Za temperature od 5 do 30 °C, a korištenjem linearnih funkcija kojima su opisani baždarni pravci, izračunate su vrijednosti potencijala za koncentracije Na^+ iona u području radnih koncentracija od 0.001 do 0.374 mol dm⁻³ (koncentracijski niz razlikovao se za 0.0005 mol dm⁻³).

Tablica 2. Primjer dijela baždarnne tablice za natrijevu ion-selektivnu elektrodu izrađenu pri brzini hlađenja otopine od 6 °C h⁻¹

Table 2. Part of calibration table for ion-selective electrode (cooling rate 6 °C h⁻¹)

$c (Na^+)$ mol dm ⁻³	$\log c$	$E_{30^\circ C}$ mV	$E_{29^\circ C}$ mV	$E_{28^\circ C}$ mV	$E_{27^\circ C}$ mV	$E_{26^\circ C}$ mV	$c (Na_2B_4O_7)$ mol dm ⁻³
0,3040	-0,517	96,2	95,8	95,5	95,1	94,7	0,1520
0,3035	-0,518	96,2	95,8	95,4	95,0	94,6	0,1518
0,3030	-0,519	96,2	95,8	95,4	95,0	94,6	0,1515
0,3025	-0,519	96,1	95,7	95,4	95,0	94,6	0,1513
0,3020	-0,520	96,1	95,7	95,3	95,0	94,5	0,1510
0,3015	-0,521	96,1	95,7	95,3	94,9	94,5	0,1508
0,3010	-0,521	96,0	95,6	95,3	94,9	94,5	0,1505
0,3005	-0,522	96,0	95,6	95,2	94,9	94,4	0,1503
0,3000	-0,523	96,0	95,6	95,2	94,8	94,4	0,1500
0,2995	-0,524	95,9	95,5	95,2	94,8	94,4	0,1498
0,2990	-0,524	95,9	95,5	95,1	94,8	94,3	0,1495

U daljnjem dijelu rada ispitivana potenciometrijska metoda primijenjena je za kontinuirano praćenje koncentracije, odnosno prezasićenosti matične otopine tijekom procesa šaržne kristalizacije dinatrijevog tetraborat dekahidrata kontroliranim hlađenjem iz otopina zasićenih pri 30 °C. Brzina hlađenja matične otopine tijekom procesa iznosila je 6 °C h⁻¹. Kristalizacija se provodila pri različitim intenzitetima miješanja ($N = 200, 300$ i 350 o. min⁻¹) uz uporabu turbinskog miješala s 4 ravne lopatice (SBT miješalo) koje je usmjeravalo tok kapljevine radialno prema stjenkama kristalizatora.

Na Slici 4 prikazan je odnos eksperimentalno određenih vrijednosti potencijala i temperature pri različitim brzinama vrtnje miješala.

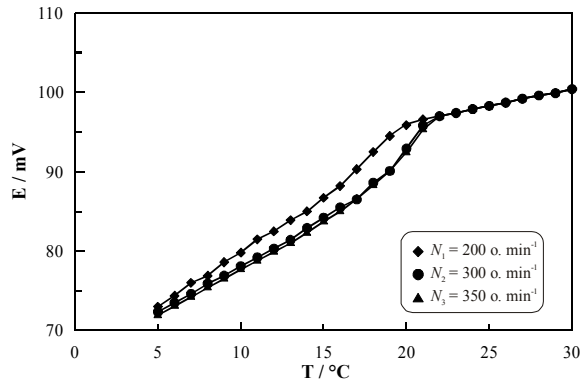

Slika 4. Promjene potencijala natrijeve ion selektivne elektrode tijekom šaržne kristalizacije dinatrijevog tetraborat dekahidrata pri različitim brzinama vrtnje miješala, $T_s = 30\text{ }^\circ\text{C}$

Fig. 4. Changes of potential of sodium ion-selective electrode during batch cooling crystallization of borax decahydrate at the different impeller speeds, $T_s = 30\text{ }^\circ\text{C}$

Na prikazanom grafu uočljivo je da se elektrodni potencijal u početnoj fazi procesa linearno smanjuje sniženjem temperature. Pojavom nukleacije, koja uzrokuje smanjenje koncentracije soli u otopini, slijedi nagli pad potencijala. Taj pad se nastavlja uslijed rasta nastalih nukleusa, odnosno kristala. Iz slike je primjetno da je pad potencijala izraženiji u sustavima s većim intenzitetom miješanja. Korištenjem eksperimentalnih podataka prikazanih na Slici 4 i baždarne tablice izrađeni su $c - T$ dijagrami za ispitivane uvjete kristalizacije (Slika 5). Na istoj slici prikazana je i topljivost dinatrijevog tetraborat dekahidrata u ispitivanom temperaturnom području, određena postupkom detaljno opisanim u literaturi (Akrap et al., 2008).

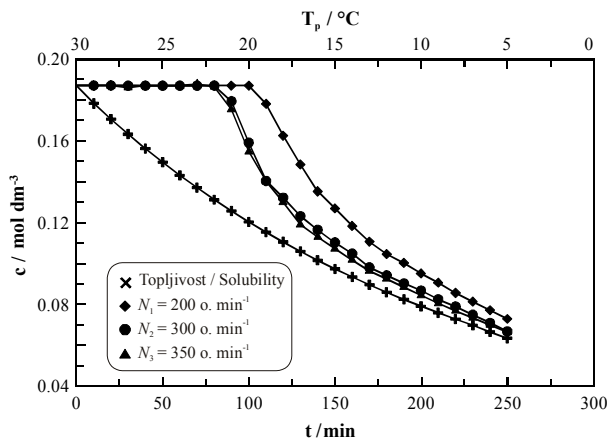

Slika 5. Promjene koncentracije matične otopine tijekom šarže kristalizacije provedene pri različiti brzinama vrtnje miješala

Fig. 5. Changes of concentration of mother liquor during batch cooling crystallization at the different impeller speeds

S obzirom da se koncentracijske promjene u procesu kristalizacije uobičajeno izražavaju kao promjene apsolutne prezasićenosti, iz razlike koncentracija otopine i ravnotežne topljivosti određena je promjena prezasićenosti pri svim ispitivanim brzinama miješanja matične otopine (Slika 6).

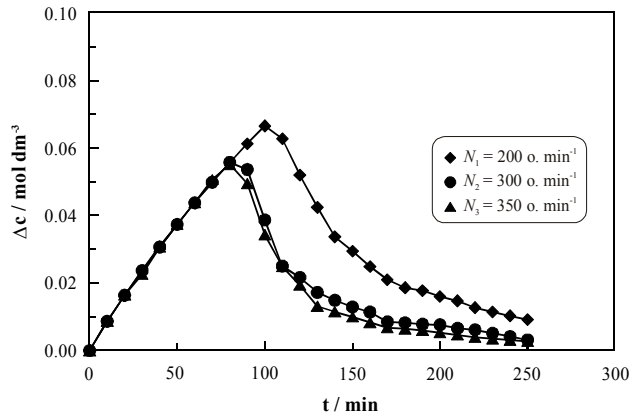

Slika 6. Promjene prezasićenosti matične otopine tijekom procesa šaržne kristalizacije boraksa pri različitim intenzitetima miješanja

Fig. 6. Changes of supersaturation of mater liquor of borax decahydrate during batch cooling crystallization at the different mixing intensity

Iz Slike 6 se uočava da je za sve ispitivane eksperimentalne uvjete trend krivulje $\Delta c - t$ istovjetan. S početkom kontinuiranog hlađenja vrijednost apsolutne prezasićenosti otopine linearno raste. U određenom procesnom vremenu krivulja postiže svoj maksimum, nakon kojeg slijedi pad vrijednosti apsolutne prezasićenosti. Bitan dio krivulje upravo je njezin vrh. On predstavlja maksimalno postignutu prezasićenost otopine, Δc_{\max} , odnosno uvijete pri kojima započinje proces nukleacije. Iz rezultata dobivenih u ovom radu uočava se da veća brzina vrtnje miješala uzrokuje pojavu nukleacije pri manjem iznosu apsolutne prezasićenosti. Također se uočava da je pri većim brzinama vrtnje iznos maksimalne prezasićenosti pri kojoj započinje nukleacija gotovo identičan, što navodi na zaključak da daljnje povećanje intenziteta miješanja ne bi utjecalo na sniženje ove veličine. Dio krivulje koji slijedi nakon maksimuma predstavlja smanjenje prezasićenosti uslijed rasta nastalih kristala i pojave sekundarne nukleacije. Rezultati ukazuju da se iznos apsolutne prezasićenosti tijekom procesa izraženije smanjuje s povećanjem brzine vrtnje miješala. Ovakav rezultat usko je povezan s otporima koji se pojavljuju pri rastu kristala, a koje uzrokuje difuzijski sloj. Povećanjem intenziteta miješanja smanjuje se debljina difuzijskog sloja, čime se omogućava brža ugradnja iona iz matične otopine u kristalnu rešetku rezultirajući većim prinosom kristala. Osim toga u sustavima s povećanim intenzitetom miješanja veća je i brzina sekundarne nukleacije što dodatno pridonosi smanjenju apsolutne prezasićenosti.

S ciljem provjere potenciometrijske metode tijekom kristalizacije vršena su učestalija uzorkovanja i analize matične otopine volumetrijskom metodom tj. kiselo-baznom titracijom s NaOH uz manitol kao indikator (Braman, 1968). Usporedba koncentracija dobivenih primijenjenim metodama prikazana je na Slici 7 iz koje se uočava veoma dobro slaganje analiziranih vrijednosti (odstupanje $\pm 1.5\%$).

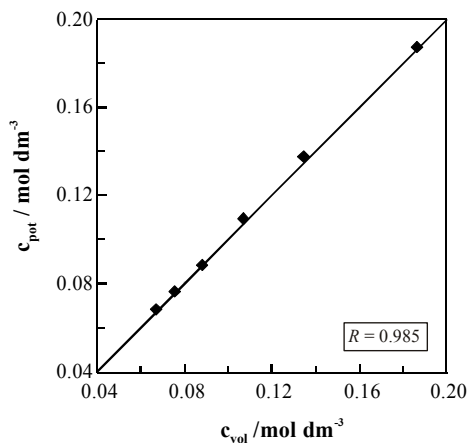

Slika 7. Usporedba koncentracija dinatrijevog tetraborat dekahidrata određenih potenciometrijskom i volumetrijskom metodom

Fig. 7. Comparison of disodium tetraborate decahydrate concentrations determined by the potentiometric and volumetric methods

Zaključak

Ispitivana potenciometrijska metoda koja se temeljila na uporabi ion-selektivne elektrode može se uspješno primijeniti za kontinuirano mjerenje koncentracije dinatrijevog tetraborat dekahidrata tijekom procesa šaržne kristalizacije hlađenjem. Pri tome je postupak baždarenja *ISE* potrebno modificirati u skladu s uvjetima provođenja kristalizacijskog postupka u kojem će metoda biti primijenjena. Tu se prvenstveno misli na brzinu hlađenja i volumen standardne otopine.

Osnovna prednost korištenja ion-selektivne elektrode tijekom procesa šaržne kristalizacije je njezina stalna uronjenost u matičnu otopinu. Na taj način se omogućuje kontinuirano praćenje promjene koncentracije matične otopine tijekom kristalizacije te uklanjanje eventualna mogućnost onečišćenja otopine uslijed njezinog uzorkovanja kojeg zahtijevaju volumetrijske analitičke metode. Ispitivana potenciometrijska metoda također omogućuje pouzdano praćenje tijekom kristalizacijskog procesa te detektiranje utjecaja procesnih parametara na promjenu prezasićenosti matične otopine kao pokretačke sile kristalizacijskog procesa.

Simboli

c	-	koncentracija otopine, (mol dm^{-3})
c^*	-	ravnotežna topljivost, (mol dm^{-3})
E	-	elektrodni potencijal, (mV)
E°	-	standardni elektrodni potencijal, (mV)
F	-	Faradayeva konstanta, (96487 C mol^{-1})
N	-	brzina vrtnje miješala, (o. min^{-1})
R	-	univerzalna plinska konstanta, ($8.314 \text{ J K}^{-1} \text{ mol}^{-1}$)
T_p	-	procesna temperatura, ($^\circ\text{C}$)
T_s	-	temperatura zasićenja otopine, ($^\circ\text{C}$)
z	-	broj elektrona
Δc	-	apsolutna prezasićenost matične otopine, (mol dm^{-3})
Δc_{\max}	-	maksimalno postignuta prezasićenost matične otopine, (mol dm^{-3})

Literatura

- Akrap, M., Kuzmanić, N., Prlić Kardum, J., Mitrović-Kessler, E. (2008): An experimental study of the effect of mixing on the crystallization of borax decahydrate. In: 11th International conference: Multiphase flow in industrial plants, AIDIC, Palermo, Italy, pp. 167-175.
- Braman, R. S. (1968): Boron determination. In encyclopedia of industrial chemical analysis, Vol. 7., Interscience Publisher, New York, USA, pp. 405.
- Genceli, G. E., Himawan, C., Witkamp, G. J. (2005): In-line determination of supersaturation and metastable zone width of $\text{MgSO}_4 \cdot 12\text{H}_2\text{O}$ with conductivity and refractive index measurement techniques, *J. Crystal Growth* 275, 1757-1762.
- Jagadeshi, D., Kubota, N., Yokota, M., Sato, A., Tavaré, N. S. (1996): Large and mono-sized product crystals from natural cooling mode batch crystallizer, *J Chem Eng Jpn* 29 (5), 865-873.
- Lewiner, F., Fevotte, G., Klein, J. P., Puel, F. (2002): An online strategy to increase the average crystal size during organic batch cooling crystallization, *Ind Eng Chem Res* 41 (5), 1321-1328.
- Mullin, J. W. (2001): Crystallization, 4th ed, Butterworth-Heinemann, Oxford, UK, pp. 86-403.
- Myerson, A. (2002): Handbook of industrial crystallization, Butterworth-Heinemann, Boston, USA, pp.1-218.
- URL: <http://www.chem.gmu.edu/results/borax.doc>. (28.01.2010).
- Urlich, J., Strege, C. (2002): Some aspects of the importance of metastable zone width and nucleation in industrial crystallizer, *J. Crystal Growth* 237-239, 2130-2135.
- Piljac, I. (1995): Elektroanalitičke metode, RMC, Zagreb, HR, str. 119-135.
- Skoog, D. A., West, D. M., Holler, F. J. (1999): Osnove analitičke kemije, Školska knjiga, Zagreb, HR, str. 381-401.

- Srinivasakannan, C., Vasantahakumar, R., Iyappan, K., Rao P. G. (2002): A study of crystallization of oxalic acid in batch cooling crystallizer, *Chem Biochem Eng Q* 16 (3), 125-129.
- Wang, S. L., Fu, Y. J., Zhang, X., Gao, Z. S. (2000): In-line bulk concentration measurement by method of conductivity in industrial KDP crystal growth from aqueous solutions, *Cryst. Res. Tech.* 35, 1027-1034.
- Yuksle, G. Y., Titiz, S., Buluctu, A. N. (1996): Solubility of sodium perborate tetrahydrate in water and sodium metaborate solutions, *J. Chem. Eng. Data* 41, 586-588.

In-line bulk concentration measurement in batch cooling crystallization of borax decahydrate

M. Akrap, D. Bralić, N. Kuzmanić

University of Split, Faculty of Chemistry and Technology, Teslina 10/V, 21000 Split, Croatia

Summary

Information of the bulk concentration is an important parameter to support process control and for the evaluation of crystallization experiments. The aim of this work was to develop appropriate method for in-line bulk concentration measurement over batch cooling crystallization of borax decahydrate. For that reason feasibility of using potentiometric method i.e. sodium ion selective electrode were investigated in details. Application of ion selective electrode requires a calibration curve which expresses the correlation between electrode potential and known concentration of bulk solution at the constant temperature. Since in batch cooling crystallization the bulk temperature changes continuously, for calibration of ion-selective electrode it is necessary to predetermine cross-correlation between the concentrations, electrode potential and temperature of the bulk solution. Therefore the calibration has to be carried out at the same process conditions as subsequent crystallization regarding to cooling rate and volume of bulk solution. In order to control potentiometric method the solution concentration was analyzed by a volumetric method as well. It was found very good agreement between these two methods. In this work crystallization was carried out at different mixing conditions. The changes of bulk concentration determined by potentiometric method as well as supersaturation changes over crystallization process are presented and analyzed.

Keywords: disodium tetraborate decahydrate, batch crystallization, ion-selective electrode, absolute supersaturation

Matematičko modeliranje kinetike heterogenih reakcijskih sustava *Modeliranje kinetike reakcijskih sustava koji imaju konverzijsku funkciju s infleksijom*

UDC: 519.87 : 66.097

E. Bacci, D. Rušić*, S. Svilović, R. Žanetić

Sveučilište u Splitu, Kemijsko-tehnološki fakultet, Teslina 10/V, 21000 Split, Hrvatska

Sažetak

Reakcijski sustavi fluid-krutina s konverzijskom funkcijom koja ima infleksiju spadaju u značajnu grupu heterogenih sustava. Do sada se kinetika modelirala jednom konverzijskom funkcijom iz koje se definira kinetička funkcija za ukupno vrijeme

procesa $(d\alpha / dt = k_0 \exp(-E / RT) \cdot f(\alpha))$, $g(\alpha) = k_0 \exp(-E / RT) \int_0^t f(\alpha) dt$. Analiza

konverzijske funkcije s infleksijom ukazuje na složeniji pristup kinetici ovog sustava. Ukazuje na potrebu temeljitijeg sagledavanja kinetike, tj. na postojanje više mehanizama koji se slijedno smjenjuju i kontroliraju ukupnu brzinu izučavanog procesa. Problem se rješava izvođenjem kinetičkih funkcija $d\alpha / dt = f(t)$ ili $d\alpha / dt = f(\alpha)$ iz implicitnih konverzijskih funkcija uz definiranje početnih uvjeta uz diferencijalne jednadžbe. Uvjeti prijelaza jednog procesa u drugi određuju se iz uočenih eksperimentalno utvrđenih karakterističnih točaka. Ovaj rad daje kinetički model temeljen na jedan i tri slijedna procesa u kojem su $f(\alpha)$ funkcije izvedene iz poznavanja mehanizama procesa. S obzirom da dolazi do promjene mehanizma mijenja se i energija aktivacije u toku odvijanja procesa. Rad predstavlja prilog sagledavanju mogućnosti kinetičkog opisa ovih sustava. Modeliranje je moguće izvesti i funkcijama empirijskog tipa. Razvijeni model se temelji na običnim diferencijalnim jednadžbama s početnim uvjetima. Ovaj rad je teorijskog karaktera te je preduvjet uspješnijem sagledavanju fenomena na krutoj fazi i projektiranju reaktora.

Ključne riječi: matematičko modeliranje, heterogeni reakcijski sustavi, konverzijska funkcija s infleksijom, kinetika

Uvod

Modeliranje procesa u kemijskom inženjerstvu temelji se najčešće na običnim ili parcijalnim diferencijalnim jednadžbama sa zadanim početnim ili rubnim uvjetima. Njihov oblik i uvjeti ovise o sustavu koji se istražuje.

Heterogeni reakcijski sustavi fluid-krutina u pravilu uključuju procese koji su rezultanta međudjelovanja između niza fenomena kao što su prijenos mase, prijenos topline, kemijske reakcije te mehanizma njenog odvijanja itd. Do sada

* rusic@ktf-split.hr

modeliranje se temeljilo na pretpostavci postojanja jednog mehanizma po kojem se proces odvija. U ovom radu predlaže se postupak modeliranja kinetike procesa temeljen na konverzijskim funkcijama $F(\alpha, t) = 0$ iz kojih se prepoznaje postojanje više mehanizama procesa koji se slijedno smjenjuju i preuzimaju kontrolu ukupne brzine procesa.

Rezultati i rasprava

Analiza konverzijskih i odgovarajućih kinetičkih funkcija

Kao što je u uvodu istaknuto zadatak modeliranja heterogenih sustava je pronaći matematičku funkciju, razvijenu iz poznavanja mehanizma procesa s kojom je moguće obuhvatiti zbivanja u ukupnom vremenu njegovog trajanja. Za ilustraciju na Slici 1 dat je primjer funkcije nukleacije i rasta koja u potpunosti opisuje sve hipotetičke eksperimentalne podatke.

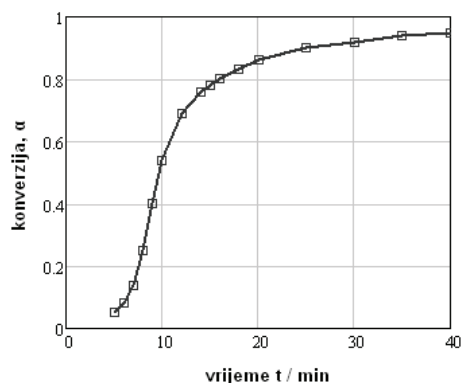

Slika 1. Opis eksperimentalnih podataka jednom mehanističkom funkcijom

Fig. 1. Description of the experimental data with mechanistic function
(conversion vs. time)

Provođenjem korelacijsko-regresijske analize dobivaju se parametri neophodni za izvođenje kinetičke funkcije što predstavlja uobičajeni kinetički opis heterogenog sustava.

Međutim, procesi u heterogenim sustavima mogu mijenjati mehanizam odvijanja što nužno uvjetuje promišljanje mogućnosti matematičkog opisa ovog problema. Prvi korak je eksperimentalno određivanje konverzijskih podataka, $\alpha - t$ iz kojih se grafičkim ili analitičkim deriviranjem određuju kinetički, $d\alpha/dt - t$ podaci. Slijedi korelacijsko-regresijska analiza kojom se procjenjuju parametri. Primjer ovog problema ilustriran je na Slici 2.

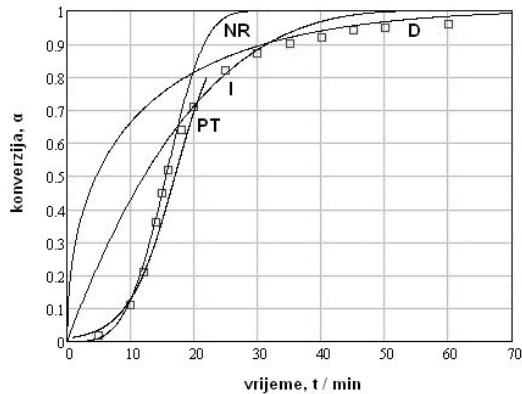

Slika 2. Testiranje različitih mehanističkih funkcija za opis ukupnog vremena trajanja procesa
Fig. 2. Testing several different mechanistic functions to describe total duration of the process

Vidljivo je da na hipotetičkim podacima nije moguće pronaći jednu mehanističku funkciju koja će u potpunosti opisati ukupno vrijeme trajanja procesa. Testirani su modeli nukleacije i rasta (*NR*), Prout-Tompkinsov model (*PT*), interakcije na granici faza (*I*) i difuzijski model (*D*). Provedena je regresijska analiza, međutim dobiveni parametri nisu bili ni približno zadovoljavajući da opišu eksperimentalne podatke. Tek nakon temeljitije analize parametara ustanovljeno je da prva dva mehanistička modela (*NR* i *PT*) istovremeno podjednako dobro opisuju početak procesa dok druga dva (*I* i *D*) slijedno njegov kraj. Očito, potrebno je pretpostaviti da se u određenim vremenima mijenjaju mehanizmi procesa u heterogenom sustavu, te da je potrebno uzeti u obzir promjenu mehanizma i razviti model iz više mehanističkih i/ili empirijskih funkcija. Postupak je opisan u tekstu koji slijedi.

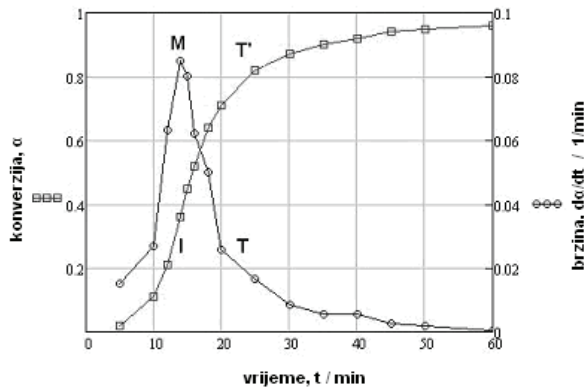

Slika 3. Konverzijske $\alpha - t$ podaci u usporedbi s dobivenom kinetičkim podacima
Fig. 3. Conversion data in comparison with the kinetic data

Kod $\alpha-t$ podataka, Slika 3, postoji točka infleksije I u kojoj se konkavni dio ($d\alpha/dt > 0$) smjenjuje konveksnim dijelom ($d\alpha/dt < 0$). U skladu s ovim uočava se postojanje akceleracijskog perioda do točke I i deceleracijskog perioda od infleksije do kraja procesa. Međutim, u ovom deceleracijskom periodu postoji točka T' od koje gradijenti konverzije značajno opadaju prema kraju procesa te se asimptotski približavaju konverziji s vrijednošću jedan. Ovo je uočljivije na kinetičkim $d\alpha/dt-t$ podacima koji pokazuju da brzina raste do točke M gdje ima najveću vrijednost. Međutim, ne mijenja se iznos brzine i vrijedi $\frac{d(d\alpha/dt)}{dt} = 0$. Do ove točke brzina raste, gradijenti su pozitivni ($\frac{d(d\alpha/dt)}{dt} > 0$) i pokazuju trend rasta. Od točke M brzina opada, njezini gradijenti su negativni ($\frac{d(d\alpha/dt)}{dt} < 0$) ali s trendom porasta do točke T . Slijedi daljnji pad brzine s negativnim gradijentima koji su se značajno promijenili. Brzina monotono pada tako da su njene promjene vrlo malene i asimptotski se približavaju brzini s vrijednošću nula.

Dakle, opisane karakteristične točke na konverzijskim i kinetičkim podacima postaju mogući kriteriji promjene mehanizma. Promjena prvog mehanizma detektira se točkom infleksije I na $\alpha-t$ podacima, ili točkom M na kinetičkim $d\alpha/dt-t$ podacima. Slijedeću promjenu mehanizma određuju točke T' i T na istim skupinama podataka. U tim točkama gradijent konverzije, $\frac{d\alpha}{dt}$ i gradijent brzine, $\frac{d(d\alpha/dt)}{dt}$ izrazito mijenjaju iznos. Za istaknuti je da ovi kriteriji ponekad

ne moraju biti uvaženi. Naime, ukoliko neka mehanistička funkcija pokazuje dobro slaganje s eksperimentalnim podacima moguće ju je koristiti sve dok je slaganje zadovoljavajuće bez obzira na model koji slijedi, a zadovoljava postavljeni kriterij (približava se točki infleksije). Takav slučaj prikazan je na Slici 5 te ukazuje na kompleksnost opisa heterogenog sustava.

U ovom radu biti će pokazano kako razviti model za slučaj da u heterogenom sustavu odvijajući proces počinje mehanizmom nukleacije i rasta po modelu Johnson-Mehl-Avrami (JMA funkcija). Kao alternativni model biti će testiran i Prout-Tomkinsov model. Od točke infleksije I (alternativno M) do točke T' (alternativno T) provjerava se mehanizam interakcije na granici faza nakon koje kontrolu preuzima unutarfaza difuzija. Ovdje je vidljivo da NR model prelazi točku M, Slika 5, ali točnije slijedi eksperimentalne podatke od modela interakcije na granici faza. Razlog je postojanje samo jednog parametra (k_r) za razliku od dvoparametarske JMA funkcije (n, k_{NR}). Predlaže se slijedeća shema slijednih procesa:

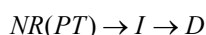

gdje je ukupno vrijeme:

$$t = \Delta t_{NR(PT)} + \Delta t_I + \Delta t_D$$

Prihvati li se ova shema slijede intervali vremena za odgovarajuće intervale konverzije:

$$\begin{array}{ll} 0 \leq t_{NR} \leq t_I & 0 \leq \alpha_{NR} \leq \alpha_I \\ t_{NR} \leq t_I \leq t_D & \alpha_{NR} \leq \alpha_I \leq \alpha_D \\ t_I \leq t_D \leq \infty & \alpha_I \leq \alpha_D \leq 1 \end{array}$$

Uvažavajući gornje sheme primjenjuje se klasični kinetički model za opis izotermne kinetike:

$$\frac{d\alpha}{dt} = k(T) \cdot f(\alpha) \quad (1)$$

Ukoliko se želi modelirati proces u kojem se smjenjuju mehanizmi nužno je uz gornju diferencijalnu jednadžbu zadati početne uvjete:

$$t_p \geq 0, \alpha_p \geq 0$$

Njenim integriranjem kao rješenje dobiva se:

$$g(\alpha) = \int \frac{d\alpha}{f(\alpha)} = k(T) \int dt \quad (2)$$

$$g(\alpha) + I = k(T)t \quad (3)$$

Neodređenim integriranjem uvodi se integracijska konstanta I , čiji će numerički iznos biti određen početnim uvjetima koji ujedno numerički određuju vrijeme i konverziju kad slijedeći mehanizam preuzima kontrolu nad ukupnom brzinom procesa.

Jednadžbe modela

Osnova za koncipiranje dijagrama toka, tj. simboličkog prikaza mogućih računalnih algoritama čine matematički elementi blokova formiranih po kriterijima matematičkog oblika (implicitne jednadžbe, diferencijalne jednadžbe, algebarske jednadžbe, eksplicitne jednadžbe) i testiranih mehanizama procesa (NR, PT, I i D). Ovakav pristup omogućava analizu problema i njegovu provjeru. Prezentirani rad je proširenje teorijskih promišljanja modeliranja izotermne kinetike i razvoja računalne podrške. Osnovni principi testirani su na modelnom sustavu hidratacije cementa (Dabić i sur., 2000).

Osnova za razvoj predloženog modela su implicitne funkcije prema relaciji (3):

$$[-\ln(1-\alpha)] + I_{NR} = k_{NR}t \quad (4a)$$

$$\ln(\alpha/(1-\alpha)) + I_{PT} = k_{PT}t \quad (4b)$$

$$1 - (1-\alpha)^{\frac{1}{3}} + I_I = k_I t \quad (4c)$$

$$(1 - (1-\alpha)^{\frac{1}{3}})^2 + I_D = k_D t \quad (4d)$$

Diferencijalne jednadžbe formiraju se deriviranjem gornjih implicitnih funkcija i dobivaju se brzine u funkciji vremena:

$$\frac{d\alpha}{dt} = nk_{NR}^n t^{n-1} e^{-(k_{NR}t)^2} \quad (5a)$$

Potrebno je napomenuti da za PT model nije moguće dobiti $d\alpha/dt = f(t)$

$$\frac{d\alpha}{dt} = 3k_I(1 - k_I t)^2 \quad (5b)$$

$$\frac{d\alpha}{dt} = \frac{3}{2}k_D \frac{(1 - (k_D t)^{\frac{1}{2}})^2}{(k_D t)^{\frac{1}{2}}} \quad (5c)$$

Analogno gornjem izvode se brzine u funkciji konverzije:

$$\frac{d\alpha}{dt} = nk_{NR}(1-\alpha)(-\ln(1-\alpha))^{\frac{1}{n}} \quad (5a)$$

$$\frac{d\alpha}{dt} = k_{PT}\alpha(\alpha-1) \quad (5b)$$

$$\frac{d\alpha}{dt} = 3k_I(1-\alpha)^{\frac{2}{3}} \quad (5c)$$

$$\frac{d\alpha}{dt} = \frac{3}{2}k_D \frac{(1-\alpha)^{\frac{2}{3}}}{1 - (1-\alpha)^{\frac{1}{3}}} \quad (5d)$$

U slijedećem bloku date su odgovarajuće integracijske konstante (algebarske jednadžbe vremena i konverzije prijelaza kontrolirajućih mehanizama):

$$I_{NR} = k_{nr}t_p - (-\ln(1-\alpha_p))^{\frac{1}{2}} \quad (6a)$$

$$I_{PT} = -k_{PT}t_p + \ln(1-\alpha_p) \quad (6b)$$

$$I_I = k_I t_p + (1-\alpha_p) \quad (6c)$$

$$I_D = k_D t_{pD} - (1 - (1-\alpha_p)^{\frac{1}{3}})^2 \quad (6d)$$

Eksplicitne konverzijske jednadžbe za kontrolirajuće mehanizme:

$$\alpha_{NR} = 1 - \exp(-k_{NR}t) \quad (7a)$$

$$\alpha_{PT} = 1 + \exp(-k_{PT}(t - t_p)^{-1}) \quad (7b)$$

$$\alpha_I = 1 - (-k(t - t_p) + (1 - \alpha_p)^{\frac{1}{3}})^3 \quad (7c)$$

$$\alpha_D = 1 - (1 - (k_D(t - t_p) + (1 - \alpha_p)^{\frac{1}{3}})^2)^{\frac{1}{2}})^3 \quad (7d)$$

U Tablici 1 i Slikama 4a, b, c i d prikazani su rezultati regresijske analize i grafički prikazi navedenih modela (NR/PT, I, D) na hipotetičkim eksperimentalnim podacima $\alpha - t$ pri temperaturama T1, T2, T3 i T4.

Tablica 1. Parametri primijenjeni u modelu

Table 1. The parameters used in the model

	Parametri				
	n	k_{NR}	k_{PT}	k_I	k_D
230	3.01	0.0193	0.0784	0.0127	0.0078
240	3.2	0.0299	0.1600	0.0157	0.0099
250	2.9	0.0580	0.2757	0.0171	0.0092
260	4.2	0.0990	0.5891	0.0190	0.0100

Tipični grafički prikaz brzine u funkciji vremena na temperaturi T3 dat na Slici 5. Isto tako predloženi model omogućava procjenu vremena prijelaza i odgovarajućih konverzija jednog mehanizma u drugi. Koristi se činjenica da su u trenutku prijelaza jednog mehanizma u drugi brzine numerički jednake $(da/dt)_{NR(PT)} = (da/dt)_I$ i $(da/dt)_I = (da/dt)_D$. Druga, u radu primijenjena, mogućnost je izjednačavanje konverzija $\alpha_{NR(PT)} = \alpha_I$ i $\alpha_I = \alpha_D$. Vrijeme i konverzija prijelaza kontrolirajućih mehanizama prikazani su u Tablici 2.

Tablica 2. Vrijeme i konverzija prijelaza kontrolirajućih mehanizama

Table 2. Times and conversions of transition of controlling mechanisms

Temp. T, °C	Vrijeme prijelaza, min			Konverzija prijelaza		
	t_{NR-I}	t_{PI-I}	t_{I-D}	α_{NR-I}	α_{PT-I}	α_{I-D}
230	39.3	36.7	60.3	0.36	0.35	0.736
240	32.8	29.3	41.8	0.613	0.519	0.782
250	24.18	20.05	27.9	0.729	0.721	0.749
260	9.9	9.9	20.2	0.629	0.631	0.891

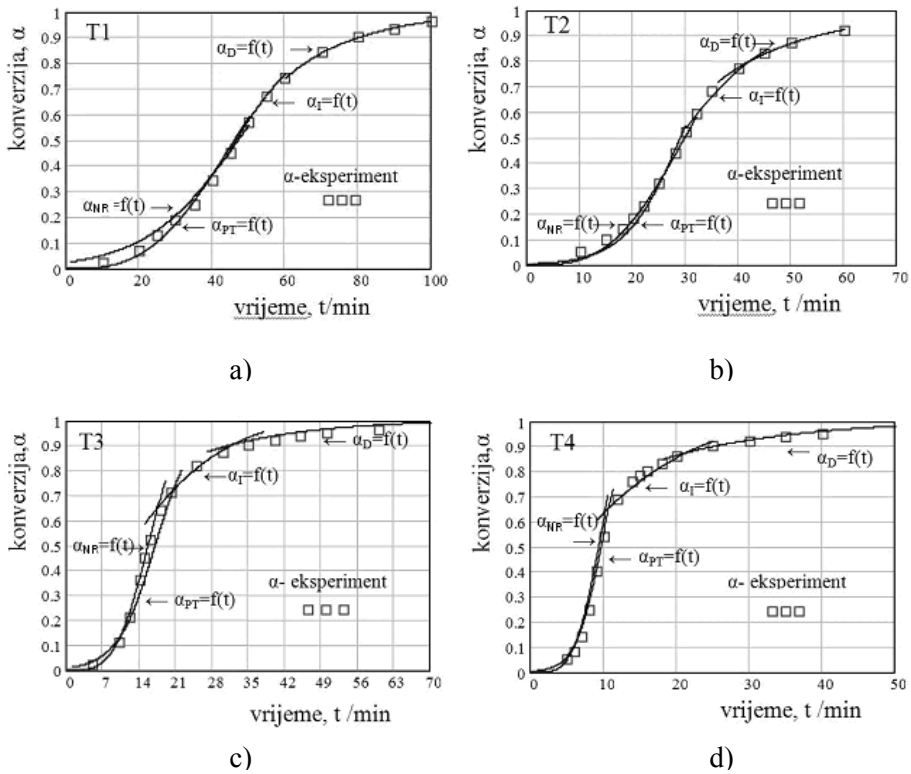

Slika 4a, b, c, d. Konverzijske funkcije u ovisnosti o vremenu
 Fig. 4a, b, c, d. Conversion vs. time diagrams

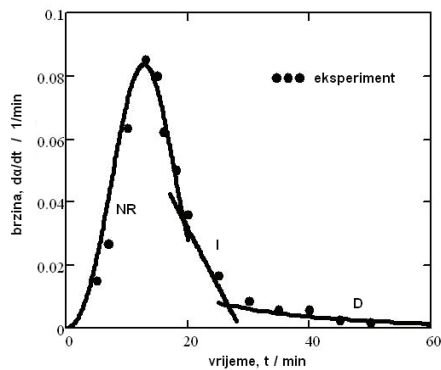

Slika 5. Brzina procesa u ovisnosti o vremenu
 Fig. 5. Speed of process vs. time

S obzirom da brzinu procesa određuju Arrheniusova funkcija $k(T)$ i konverzijska $f(\alpha)$ od interesa je ispitati i temperaturnu funkciju. Kako dolazi do promjene mehanizma mora doći i do promjene iznosa predeksponencijalnog faktora i energije aktivacije (Slika 6).

$$\ln(k_i) = \ln(k_{A0,i}) - E / RT \quad i=NR,PT, I, D \quad (10)$$

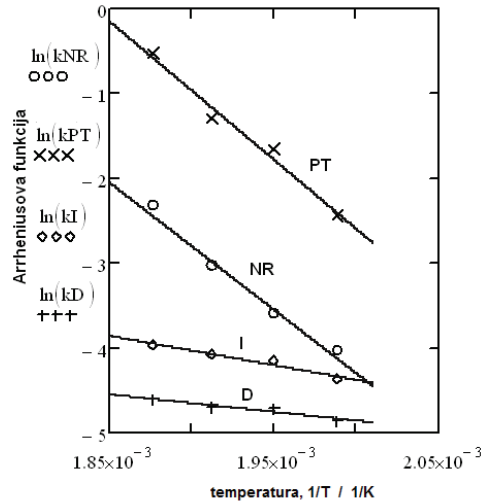

Slika 6. Parametri u ovisnosti o temperaturi
 Fig. 6. Parameters vs. temperature

Dakle, u toku odvijanja procesa energija aktivacije nije konstatna veličina već se mijenja s promjenom mehanizma. S obzirom da je ovo rad teorijskog karaktera s hipotetičkim podacima na kojima je testiran model s naglaskom na postojanje više mehanizama, funkcija $k(T)$ nije posebno obrađivana. Međutim, bez obzira na hipotetičke podatke ukoliko se energija aktivacije izrazi u $\text{kJmol}^{-1}\text{K}^{-1}$ vrijednosti su u Tablici 3. Vrijednosti predeksponencijalnog faktora mogu se odrediti iz grafa na Slici 6.

Tablica 3. Energija aktivacije
 Table 3. The activation energy

Energija aktivacije, $\text{kJ mol}^{-1} \text{K}^{-1}$			
$E_{NR} 10^4$	$E_{PT} 10^4$	$E_I 10^4$	$E_D 10^4$
1.50	1.63	0.346	0.206

Konverzijske funkcije s infleksijom pojavljuju se u organskim sustavima (termička razgradnja polivinil klorida (PVC), polietilen oksida (PVO), poli β -hidroksi butirata (PHB) itd.). Teorijskim kinetičkim istraživanjima bave se Vyazovkin, (2001),

Vyazovkin i sur. (2001), Vyazovkin i sur. (1997). Međutim, ne bave se mehanizmom već daju matematički postupak određivanja energije aktivacije i predeksponencijalnog faktora. Anorganske sustave (hidratacija cementnih sustava (cement-voda), hidratacija $CaSO_4 \times 0.5H_2O$), istražuju Dabić i sur. (2000), Brown i sur. (1985), Wang i sur. (2010), Krstulović i sur. (2000), Hand, R.J. (1994). Elektrokemijske sustave (proces i otapanja metala, nanošenje metala na metal u korozivnim procesima, itd.), izučavaju Bockris i sur. (1993), Bard (1994). Modeliranje kinetike svih ovih sustava moguće je primjenom predloženog modela uz uvjet prethodnih eksperimentalnih istraživanja mehanizama koji se smjenjuju i slijedno kontroliraju brzinu. Računalna podrška u ovom radu temelji se na matematičkom alatu MathCad v.14. Razvijeni program uključuje podprograme za unos i grafičku prezentaciju podataka, korelacijsko-regresivnu analizu, grafički prikaz analitičkih funkcija te potrebne podprograme za matematičke proračune jednadžbi modela.

Zaključak

Konverzijske funkcije s točkom infleksije vrlo često se pojavljuju u heterogenim anorganskim i organskim sustavima. U ovom radu predložen je model razvijen iz kinetičke funkcije $\frac{d\alpha}{dt} = f(T) \cdot f(\alpha)$ sa zadanim početnim uvjetima i implicitne konverzijske funkcije $F(\alpha, t) = 0$. Model pretpostavlja postojanje izmjene mehanizma procesa kod odgovarajuće konverzije i vremena što se procjenjuje iz eksperimentalnih podataka. Na temelju hipotetičkih eksperimentalnih podataka pokazano je kako se razvijaju konverzijske funkcije u vremenu kada nema promjene mehanizma procesa i kad brzinu procesa kontroliraju slijedno tri mehanizma. Također, pokazano je da se isti interval procesa može jednako dobro opisati s dvije različite funkcije (NR i PT). U ovom slučaju treba provesti eksperimentalna istraživanja i utvrditi mehanizam. Matematičkim modeliranjem moguće je predvidjeti vrijeme i konverziju prijelaza jednog mehanizma u drugi i provjeriti eksperimentalnim podacima. Također, predloženi su kriteriji te odstupanja od njih za određivanje ovih prijelaza. Kod izučavanog procesa zbog promjene mehanizma dolazi do promjene energije aktivacije i predeksponencijalnog faktora.

Literatura

- Bard, A. J. (1994): *Integrated Chemical Systems: A Chemical Approach to Nanotechnology*, New York, John Wiley and Sons, str. 184-225.
- Bockris, J.O.M. and Khan, S. U. M. (1993): *Surface Electrochemistry: A Molecular Level Approach*, New York: Plenum. Press, str. 213-392.
- Brown, P.W., Pommersheim, J., Frohnsdorff, G. (1985) A kinetic model for the hydration of tricalcium silicate, *Cem. Concr. Res.* 15, 35-41.
- Dabić, P., Krstulović, R., Rušić, D. (2000): A new approach in mathematical modelling of cement hydration development, *Cem. Concr. Res.* 30, 1017-1021.

- Hand, R.J. (1994): The kinetics of hydration of calcium sulphate hemihydrate: A critical comparison of the models in the literature, *Cem. Concr. Res.* 24, 885-895.
- Krstulović, R., Dabić, P.(2000): A conceptual model of the cement hydration process, *Cem. Concr. Res.* 30, 693-698.
- Vyazovkin, S., Wight, C. A.(1997): Kinetics in solids, *Annu. Rev. Phys. Chem.* 48, 125-149.
- Vyazovkin, S. (2001): Modification of the integral isoconversion method to account for variation in the activation energy, *Journal of Computational Chemistry*, 22, 178-183.
- Vyazovkin, S., Clawson, J. S., Wight, C. A. (2001): Thermal dissociation kinetics of solid and liquid ammonium nitrate, *Chem. Mater.* 13, 960-966.
- Wang, X. Y., Lee, H. S., Park, K. B., Kim, J. S. Golden J. S. (2010): A multi-phase kinetic model to simulate hydration of slag–cement blends, *Cem. Concr. Composites* 32, 468–477.

Mathematical modelling of kinetics of heterogeneous reaction systems *Modelling of kinetics of reaction systems having a conversion function with inflexion*

E. Bacci, D. Rušić, S. Svilović, R. Žanetić

University of Split, Faculty of Chemistry and Technology, Teslina 10/V, 21000 Split, Croatia

Summary

Fluid – solid reaction systems having a conversion function with inflexion form an important group of heterogeneous systems. So far their kinetics has been modelled by a conversion function that would define the kinetic function for the total process time

($d\alpha/dt = k_0 \exp(-E/RT) \cdot f(\alpha)$) yielding $g(\alpha) = k_0 \exp(-E/RT) \int_0^{\alpha} f(\alpha) dt$). The analysis of

the conversion function with inflexion indicates a more complex approach to the kinetics of such systems. It indicates a need for a deeper insight into the kinetics, i.e. existing of several mechanisms that follow one another in sequence and govern the overall rate of the process studied. The problem is solved by carrying out kinetic functions $d\alpha/dt = f(t)$ or $d\alpha/dt = f(\alpha)$ from conversion functions $\alpha = f(t)$ by defining the initial conditions for the differential equation. The conditions for transition from one process into another are determined from observed experimentally established characteristic points. This study introduces a kinetic model based on one and three processes in sequence in which $f(\alpha)$ functions have been derived from the knowledge of the process mechanisms. As mechanisms change, the activation energy changes during process development. This study is a contribution to the overview of possibilities of kinetic descriptions of such systems. Modelling can also be done with the empirical type functions. The model developed is based on standard differential equations with initial conditions. This study is of theoretical nature and is a prerequisite for better understanding of phenomena in the solid phase and better reactor design.

Keywords: mathematical modelling, heterogeneous reaction systems, conversion function with inflexion, kinetics

Priprava silika gela uz dodatak PVAL-a sol-gel metodom

UDC: 544.72 : 678.6.02

P. Dabić*, P. Krolo, D. Barbir, M. Marguš

Sveučilište u Splitu, Kemijsko-tehnološki fakultet, Teslina 10/V, 21000 Split, Hrvatska

Sažetak

U radu je provedeno dobivanje poroznog silika-gela sol-gel postupkom uz dodatak poli(vinil alkohola), (PVAL). Proces dobivanja silikatnog sola proveden je uz dodatak kiselog katalizatora i točno definirano vrijeme intenzivnog miješanja. Pripravljeno je 4 sola pri temperaturi od 60 °C, uz intenzivno miješanje i reakcijsko vrijeme od 90 minuta. Dobivenim silikatnim solovima, nakon 12 sati njegovanja pri sobnim uvjetima dodano je 3, 5, 10 i 15 mas. % PVAL-a te su solovi razdijeljeni u dvije serije. Prva serija uzoraka sušena je 24 sata pri 60 °C u vakuum sušioniku, dok je druga serija uzoraka njegovana 12 dana pri 60 °C u vakuum sušioniku uz konstantan podtlak od 30 kPa. Uzorci iz obje serije dodatno su sušeni pri 130 °C do konstantne mase zatim su žareni pri 700 °C. Silikatni gelovi iz obje serije sušenjem pri 130 °C raspali su se na nepravilne oblike, promjera do 5 mm. Silika-gel s manjim udjelom dodatka raspao se na sitnije komade. Silika-gel pripremljen uz dodatak PVAL-a nakon žarenja ostao je sa silikatnom mrežom bez organske komponente, a nastale pore trebale bi biti s dimenzijama i geometrijom koju su imale molekule PVAL-a.

Ključne riječi: sol-gel postupak, silika gel, poli(vinil alkohol)

Uvod

Istraživanjem sol-gel procesa razvijeno je dosta postupaka za dobivanje materijala naročitih svojstava, koji se klasičnim kemijskim postupcima nisu mogli proizvesti ili bi njihovo dobivanje bilo neisplativo. Kemija sol- gel postupaka sastoji se od reakcija hidrolize metalnih alkoksida za dobivanje sola te reakcija kondenzacije, kada dolazi do ugušćivanja sola i prelaska u stanje gela. Reakcije hidrolize i kondenzacije prikazane su jednadžbama (1-3) na primjeru tetraetilortosilikata, (TEOS):

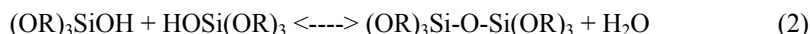
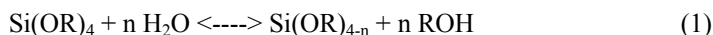

ili

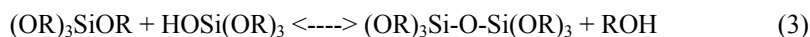

gdje je: OR alkoksidna skupina.

* dabic@ktf-split.hr

Izborom uvjeta provedbe dobivanja sola i kasnije njegovanja gela moguće je dobiti različite oblike proizvoda: tanki filmovi, prah definirane finoće, vlakna ili monolitni proizvod. Osnovni uvjeti koji se mogu mijenjati odnose se na izbor kiselog ili baznog katalizatora hidrolize, omjer metalnog alkoksida i alkohola, temperatura i vrijeme provedbe postupka, intenzitet miješanja, režim sušenja i kasnije žarenja proizvoda i drugo (Wright et al., 2003).

Postupak dobivanja silika gela sol-gel postupkom istraživalo je više autora (Buckley et al., 1994; Parashar et al, 1996; Korteuso et al. 2001) te su utvrdili najpovoljnije uvjete za provedbu postupka. Uvođenjem organske komponente u sintetizirani sol otvaraju se nove mogućnosti dizajniranja konačnog proizvoda. Prevođenjem takvog sola u gel te naknadnim sušenjem i žarenjem nastalog silika gela, organski dio izgori, a na mjestima organskih molekula ostat će pore točno definirane geometrije i veličine. Pored navedenih osnovnih uvjeta za provedbu procesa jako je bitan izbor organske komponente i njegovala kompatibilnost u sustavu alkoxid-PVAL-voda. U istraživanjima Tamake et al. 1998. kao pogodan organski dodatak u sustavu TEOS-a pokazao se PVAL te je sintetiziran hibridni polimer PVAL / silika gel. Dodatak PVAL-a u pripremljeni sol na bazi TEOS-a istraživali su Jie et al. 2004. s ciljem dobivanja biostakla s definiranim makroporama. U ovome radu istraživao je utjecaj koncentracije dodanog PVAL-a u pripremljeni sol te uvjeti njegovanja i termičke obrade nastalog gela.

Materijali i metode

Za pripremu silikatnog sola korišten je tetraetilortosilikat (TEOS), (Fluka, p.a.), etilni alkohol (EtOH), (Kemika, 96 % p.a.), klorovodična kiselina (Carlo Erba, 37 %, p.a.) i demineralizirana voda specifične provodnosti $0.054 \mu\text{Scm}^{-1}$, priređena obradom destilirane vode ionskim kolonama Millipore-Simplicity. U pripremljeni sol dodavana 5 % otopina poli(vinil alkohola) (PVAL), priređena otapanjem krutog PVAL-a (Karbon, Zagreb) u demineraliziranoj vodi uz intenzivno miješanje pri temperaturi od 60 °C. Sinteza silikatnog sola provedena je prema Buckley-u po predloženim uvjetima u okrugloj tikvici volumena 500 cm³ uz intenzivno miješanje pomoću magnetne miješalice Rotamix MMH (Tehnica, Slovenija). Radi jednolikog zagrijavanja i održavanja konstantne temperature procesa tikvica je umetnuta u kalotu Isopod G2/2L (Tyco Thermal Control Corp., SAD). Njegovanje sola provedeno je u vakuum sušioniku (Industrieofenbau, Njemačka), gdje je moguće održavati željeni podtlak i temperaturu. Podtlak od oko 30 kPa održavan je pomoću vakuum pumpe Air Cadet (Grayedge Pump and Industrial, SAD). Korišten je i obični sušionik ST-01/02 (Instrumentaria, Zagreb). Žarenje gela provedeno je u laboratorijskoj električnoj peći pri 700 i 750 °C.

Postupak pripreme reaktanata bitan je za pravilno izvođenje sinteze i odvijao se na sljedeći način. U graduirani cilindar nalije se 30 cm³ TEOS-a te se doda 31 cm³ etanola i prenese se u reakcijsku tikvicu. Uključi se magnetna mješalica i

uspostavi intenzivno miješanje, a grijanje se postiže regulacijom na kaloti. U cilindar se nalije 38 cm³ demineralizirane vode i doda 3-4 kapi konc. HCL-a te se prenese u reakcijsku tikvicu. Početna pH vrijednost u tikvici treba biti oko 3 i po potrebi se podese dodavanjem još kiseline. Temperatura se održavla na 60 °C, a kontrolira se termometrom uronjenim u reaktante.

Molarni omjer TEOS : etanol : H₂O u provedenim sintezama silikatnog sola bio je 1 : 4 : 16. Prema reakciji (4) vidi se da je za potpunu hidrolizu potrebno 4 mola vode po jednom molu TEOS-a. Višak vode primijenjen je da bi reakcijska ravnoteža preferirano išla u smjeru nastajanja produkata.

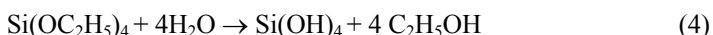

Provedeno je pri istim uvjetima pet sinteza solova, koji su pohranjeni u plastične spremnike i 12 sati su bili su pri sobnim uvjetima. Nakon 12 sati u četiri spremnika dodana je 5 % otopina PVAL-a tako da je udio krutog PVAL-a prema TEOS-u iznosio 3, 5, 10 i 15 mas. %, Tablica 1. U jedan sol nije dodavan PVAL.

Tablica 1. Volumen 5 %-nih otopina PVAL-a potreban da udjel krutog PVAL-a prema TEOS-u iznosi 3, 5, 10 i 15 mas. %

Table 1. Volume of 5 % PVAL solution needed that share of a solid PVAL against TEOS is 3, 5, 10 and 15 wt. %

Uzorak	mas. % PVAL	m(PVAL) 100% g	m(PVAL)5% g	V(PVAL)5% cm ³
1	3	0.823	16.46	16.14
2	5	1.315	27.43	26.89
3	10	2.743	54.86	53.78
4	15	4.115	82.29	80.86

Solovi su razdijeljeni u dvije serije, oznaka A i B. Uzorci serije A preneseni su u vakuum sušionik i 24 sata sušeni su uz podtlak pri temperaturi od 60 °C s ciljem ulanjanja tekuće faze (alkohol i voda), koja nastaje pri reakcijama kondenzacije (2) i (3). Iduća faza je sušenje nastalog gela u običnom sušioniku pri 130 °C u trajanju od 24 sata. Solovi serije B njegovani su u vakuum sušioniku 12 dana pri 60 °C i uz podtlak od 30 kPa, a nakon toga sušeni su pri 130 °C još 24 sata. Nastali gelovi iz obje serije žareni su u laboratorijskoj peći pri 700 °C, a nakon hlađenja i odvaga, žareni su 1 sat pri 750 °C.

Rezultati i rasprava

Određivanje optimalnih uvjeta provedbe sinteze pojedinih sol-gel presesa obično je dugotrajno i temelji se na provedbi niza eksperimenata, kojih je to više što je sustav složeniji i što je više parametra koji se mogu mijenjati. Sinteza sola uz

prekursor TEOS obično čini trofazni sustav TEOS-EtOH-voda (Slika 1), gdje je za provedbu uspješne hidrolize potrebno osigurati takav omjer komponenata da budu mješljive.



Slika 1. Fazni dijagram sustava TEOS – alkohol – voda
Fig.1. Phase diagram of system TEOS – alcohol – water

Prema Buckley-u taj odnos treba biti 1:4:16, znači dosta visok suvišak vode, a početni dodatak alkohola nužan je radi osiguranja međusobne mješljivosti reaktanata. Temperatura provedbe procesa je 60 °C što osigurava dovoljnu brzinu hidrolize. Nakon sinteze i njegovanja 12 sati pri sobnoj temperaturi nije došlo do geliranja solova niti ima vidljivih promjena uzoraka. Uzorci serije A nakon 24 sata u vakuum sušioniku pri 60 °C prešli su u gel, koji se raspao na nepravilna zrna s promjerom oko 5 mm, Slika 2.



Slika 2. Izgled silikatnog gela nakon sušenja u vakuum sušioniku, 24 sata pri 60 °C
Fig. 2. The appearance of silica gel after drying in a vacuum dryer, 24 hours at 60 °C

Također došlo je i do blagog obojenja uzoraka kojima je dodan PVAL, što se pojačalo sušenjem pri 130 °C te žarenjem. Uzorci serije B pretrpjeli su vizualno iste promjene kao i oni iz serija A. Razlike su primjetne nakon žarenja pri 700 °C i 750 °C, gdje su gubitci mase znatno razlikuju za uzorke serije B, Tablica 2.

Tablica 2. Gubitci mase žarenjem (g.ž.) uzoraka serije A i B pri 700 °C i nakon odvage pri 750 °C te ukupan gubitak žarenjem (Σ g.ž.)

Table 2. Weight loss on ignition of samples of series A and B at 700 °C and after weight at 750 °C and the total loss on ignition

Uzorak	Serija A			Serija B		
	g.ž. /% 700°C	g.ž. /% 750°C	Σ g.ž. /%	g.ž. /% 700°C	g.ž. /% 750°C	Σ g.ž. /%
0	17.21	0.01	17.22	10.23	0.00	10.23
1	18.99	0.07	19.06	12.80	0.03	12.81
2	22.24	0.17	22.41	13.56	0.42	13.98
3	23.48	1.86	25.34	19.64	0.67	20.31
4	27.16	1.39	28.55	24.73	0.86	25.59

Ovo upućuje da su uzorci serije B imali potpuniju kondenzaciju i oslobodili više tekuće faze (vode i alkohola) koja je otparila sušenjem. Obradom podataka iz Tablice 2 moguće je odrediti koliko se PVAL-a žarenjem ukloni iz pripremljenih silika gelova. Vrijednosti gubitaka žarenjem za uzorke silika gela uz dodatak PVAL-a umanje se za vrijednost gubitka mase uzorka bez dodatka i rezultat je postotak uklonjenog PVAL-a. Rezultati su prikazani na Slici 3, gdje se krivulje obje serije uzoraka mogu usporediti sa stvarno dodanim mas. % PVAL-a (crtkana krivulja). Uočava se da su vrijednosti uzoraka serije B bliže stvarnim vrijednostima. Ova činjenica upućuje da njegovanje sola pri nižim temperaturama kroz dulje vrijeme ima utjecaja na kvalitetu dobivenog gela, ali se cijena takvog proizvoda povećava.

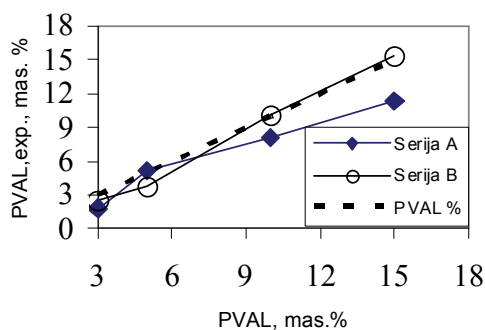

Slika 3. Prikaz gubitaka žarenjem (g.ž.) uzoraka serije A i B umanjenih za vrijednosti g. ž. kontrolnog uzorka (bez PVAL-a). Crtkana linija opisuje stvarno dodani mas. % PVAL-a
Fig. 3. Preview loss on ignition of samples of series A and B minus the loss on ignition value of control sample (without PVAL). Dashed line describes the actual added wt. % of PVAL

Provedena metoda primjenjiva je za pripremu poroznog silika-gela, ali za utvrđivanje optimalnih parametara procesa potrebno je izvršiti daljnja istraživanja u smislu potvrde dimenzija, oblika i zastupljenosti nastalih pora u silika gelu.

Zaključak

Provedba dobivanja sola iz smjese TEOS-a, vode i alkohola uspješna je uz intenzivno miješanje pri temperaturi 60 °C, kada su reakcije dovoljno brze, a alkohol umjereno hlapi iz sustava. Nakon 12 sati pri sobnim uvjetima solovi su viskozni i bezbojni, nije došlo do geliranja. Kontrolni sol je bez dodataka, a u ostale je dodano 3, 5, 10 i 15 mas.% PVAL-a. Geliranje solova nastupilo je nakon sušenja pri 60 °C u vakuum sušioniku nakon 24 sata. Dobiveni gelovi raspali su se na nepravilna zrna promjera oko 5 mm, a zrna su bila veća za uzorke s većim udjelom PVAL-a. Došlo je i do pojave boje kroz cijelu masu silika gela, a obojenje se intenziviralo sušenjem pri višim temperaturama i žarenjem. Iste vizualne promjene uočene su i kod uzoraka serije B. Žarenjem uzoraka došlo je do gubitka mase radi izgaranja organske komponente te su nastale pore čiji bi oblik i dimenzije trebale odgovarati onima koje su imale i organske molekule. Gubitak mase uzoraka gela serije B znatno je manji u odnosu na seriju A, radi potpunije kondenzacije pri nižim temperaturama. Provedena metoda primjenjiva je za pripremu poroznog silika-gela. Neophodna su daljnja istraživanja za temeljitu karakterizaciju dobivenog silika gela.

References

- Wright, J. D., Nico, A. J., Sommererdijk, M. (2003): Sol - gel Materials Chemistry and Applications, New York, USA: Academic press, 15 - 31.
- Buckley, A.M., Greenblay, M.J. (1994): Sol-gel preparation of silica gel, *J. Chem. Ed.* 71 (7), 599-602.
- Parashar, V.M., Raman, V., Bahl, O.P. (1996): Sol- gel preparation of silica gel monoliths. *J. of non cristal solids* 201, 150–152.
- Korteuso, P. (2001): Sol – Gel Derived Silica Gel Monoliths and Macroparticles as Carrier in Controled Drug Delivry in Tissue Administration, PhD Thesis, Helsinki, Finland: University of Helsinki, 10 - 22.
- Tamaki, R., Chujo, Y.(1998): Synthesis of Poly(vinyl-alcohol) / silica Gel Polymer Hybrids by In-Situ Hydrolysis Method, *Appl. Organometal. Chem.* 12, 755-762.
- Jie, Q., Lin, K., Zhong, J., Shi, Y., Lin, Q., Chang, J., Wang, R. (2004): Preparation of Macroporous Sol–Gel Bioglass Using PVA Particles as Pore Former, *J. of Sol–Gel Science and Tech.* 30, 49-61.

Preparation of silica gel with addition PVAL using sol-gel method

P. Dabić, P. Krolo, D. Barbir, M. Marguš

University of Split, Faculty of Chemistry and Technology, Teslina 10/V, 21000 Split, Croatia

Summary

The work was carried out obtaining porous silica-gel with sol-gel process, with the addition of poly (vinyl alcohol) (PVAL). The silica sol obtaining process was carried out with stoichiometric conditions with the addition of an acidic catalyst and accurately defined period of intense mixing. There were prepared 4 sols at a temperature of 60 °C, with intense mixing and reaction time of 90 minutes. After 12 hours of fostering at ambient conditions, there were added 3, 5, 10 and 15 wt. % PVAL to obtained silica sols and these sols were divided into two series. The first series of samples were dried for 24 hours at 60 °C in a vacuum dryer, while the second series of samples were fostered 12 days at 60 °C in a vacuum dryer with the constant underpressure of 30 kPa. Samples from both series were additionally dried at 130 °C to constant mass and were annealed at 700 °C. Silica gels from both series were crumbled into irregular shape with a diameter up to 5 mm by drying at 130 °C. Silica-gel with a smaller amount of the addition was crumbled into smaller pieces. Silica-gel was prepared with the addition of PVAL and after annealing it was remained with the silica network without organic components and formed pores had the dimensions and geometry of PVAL molecules.

Keywords: sol-gel method, silica gel, poly (vinyl alcohol)

Mogućnost dobivanja unimodalne raspodjele veličina kristala glicina

UDC: 577.112.382

M. Hrkovac*, J. Prlić Kardum, A. Sander

Sveučilište u Zagrebu, Fakultet kemijskog inženjerstva i tehnologije, Marulićev trg 20,
10000 Zagreb, Hrvatska

Sažetak

U pokušaju da se dobije unimodalna raspodjela veličina kristala, postupkom šaržne kristalizacije glicina iz vodene otopine, ispitan je utjecaj hidrodinamičkih uvjeta i količine dodanog cjepiva. Od parametara koji utječu na hidrodinamiku sustava ispitan je utjecaj vrste i veličine miješala te brzine vrtnje miješala. Korištene su četiri vrste miješala koja uzrokuju različit tok unutar kristalizatora: turbinsko miješalo s 3 savinute lopatice i prstenom ($d_m = 5$ cm), *Rushtonovo* miješalo (4 i 6 lopatica; $d_m = 3,5$ cm), centrifugalno miješalo ($d_m = 5$ cm) i turbinsko miješalo sa 4 lopatice nagnute pod 45° ($d_m = 3,5$ i 5 cm). Brzina vrtnje miješala bila je 300 i 550 min^{-1} . Za većinu provedenih eksperimenata dobivene su višemodalne funkcije raspodjele. Unimodalna funkcija raspodjele dobivena je za turbinsko miješalo s 3 savinute lopatice i prstenom pri brzini vrtnje miješala od 300 min^{-1} . Naime, navedeno miješalo pojačava aksijalni tok u kristalizatoru. Istražen je utjecaj količine i veličine cjepiva dodanog unutar metastabilne zone. Dodatkom cjepiva održava se niži stupanj prezasićenosti te su dobivene jednolikije raspodjele veličina, ali se mijenja i oblik kristala. Porastom veličine i količine cjepiva dobiva se unimodalna raspodjela veličina kristala.

Gljučne riječi: cijepljena kristalizacija, glicin, hidrodinamički uvjeti, miješala

Uvod

Glicin je najjednostavnija aminokiselina, pronađena u proteinima živih organizama, kemijske formule: $\text{NH}_2\text{CH}_2\text{COOH}$. Kristalizira u tri različita polimorfna oblika (α , β i γ). γ oblik je najstabilniji i kristalizira u trigonalnom sustavu, tvoreći bipiramidu (Yang et al., 2008; Baran and Ratajczak, 2005; He et al., 2006). α glicin ima monoklinsku strukturu, kristalizacijom se formira tetragonska prizma (Bouchard et al., 2008; Murli et al., 2003). Osnovni oblik β glicina također je tetragonska prizma (prozirna). Grupiranjem ovog osnovnog oblika nastaje forma morskog ježa (Bouchard et al., 2008).

Prijelaz γ -glicina u α -glicin odvija se pri povišenoj temperaturi (~ 170 °C) dok se obrnuta transformacija α -glicina u γ -glicin odvija u uvjetima povišene vlažnosti. β -glicin pri sobnoj temperaturi uz prisutnost vlage vrlo brzo prelazi u α - i γ -glicin.

* mhrkovac@fkit.hr

Pregledom literature, ustanovljeno je da se polimorfi glicina mogu dobiti kristalizacijom na različite načine (Hamond et al., 2008; Srinivasan, 2008; Yang et al., 2008; Dhanaraj and Rajesh, 2009; Ferreira et al., 2004; Moscosa-Santillán et al., 2000). α -glicin nastaje uglavnom kristalizacijom iz vodenih otopina hlađenjem, u kojima su dimeri molekula povezani jakom vodikovom vezom (NH---O). pH vrijednost otopine također utječe na nastajanje pojedinog polimorfa gdje se u kiselom ili lužnatom mediju uglavnom dobiva γ -glicin, a u neutralnom mediju α -glicin. Dodatkom aditiva inhibira se rast α -glicina u svrhu nastajanja γ -glicina. β -glicin nastaje iz zasićenih vodenih otopina pri povišenim temperaturama uz dodatak antiotapala (etanol, metanol, propanol, aceton), liofilizacijom (sušenje zaleđivanjem) te toplinskom dekompozicijom kompleksa aminomalonske kiseline i glicina.

Promjenom uvjeta provedbe procesa kristalizacije (brzina hlađenja, vrsta otapala, intenziteta miješanja) ili dodatkom pomoćne komponente (antiotapala, aditiva) dobivaju se kristali različitih granulometrijskih svojstava, ali je moguće utjecati i na nastanak različitih polimorfa.

Odabirom optimalnih procesnih uvjeta, nastaju pravilni oblici kristala unimodalne, uske raspodjele veličina. Odabrani hidrodinamički uvjeti trebaju osigurati dobru izmiješanost suspenzije unutar kristalizatora kako bi se osigurao rast svih kristala. Proces kristalizacije može biti kontroliran i dodatkom cjepiva određene veličine, L_s i mase, m_s unutar metastabilne zone. Kristali nastali cijepljenom kristalizacijom ovise o načinu proizvodnje cjepiva, tehnici cijepljenja te količini i veličini cjepiva (Myerson, 2002). Održavanjem prezasićenosti unutar granice metastabilne zone sprječava se primarna nukleacija te rastu samo kristali dodanog cjepiva.

Svrha ovog rada bila je ispitati utjecaj promjene hidrodinamičkih uvjeta te dodatka različitih veličina i mase cjepiva na granulometrijska svojstva i strukturu nastalih kristala.

Materijali i metode

Aparatura

Za kristalizaciju vodene otopine glicina hlađenjem korišten je kristalizator s ravnim dnom s ugrađena 4 razbijala i miješalom. Volumen otopine u kristalizatoru iznosio je 840 ml. Promjer posude iznosi $D=9,7$ cm, a udaljenost miješala od dna kristalizatora $1/3D$. Početna koncentracija otopine bila je $34 \text{ g}_{\text{solid}}/100 \text{ ml}_{\text{H}_2\text{O}}$, a temperatura otopine se mijenjala od $T=51$ do 20 °C brzinom hlađenja od 8° Ch^{-1} . Odabrana brzina hlađenja kontrolirana je termostatom (*Julabo CF41*) spojenim na računalo. Raspodjela veličina kristala (RVK) određena je suhim sijanjem kroz standardizirana sita (90 do 3000 μm), a oblik dobivenih kristala određen je pomoću

svjetlosnog mikroskopa *Motic BA200*. Na mikroskop je spojena kamera povezana s računalom, a uzorci su analizirani uz pomoć računalnog programom *Motic Plus*.

Mjerenje koncentracije vodene otopine glicina

Koncentracija je određivana gravimetrijskom metodom, koja se sastoji od uzorkovanja profiltrirane otopine direktno iz kristalizatora za vrijeme provedbe kristalizacije, u definiranim vremenskim intervalima. Uzorci su vagani na analitičkoj vagi, a zatim sušeni do konačne mase te ponovno vagani. Iz razlika masa određena je koncentracija glicina u otopini.

Vrste miješala

Korištene su četiri vrste miješala koja uzrokuju različit tok unutar kristalizatora. Turbinsko miješalo s 3 savinute lopatice i prstenom ($d_m = 5$ cm), centrifugalno miješalo ($d_m = 5$ cm) i turbinsko miješalo sa 4 lopatice nagnute pod 45° ($d_m = 3,5$ i 5 cm) uzrokuju aksijalni tok fluida unutar kristalizatora dok *Rushtonovo* miješalo (4 i 6 lopatica; $d_m = 3,5$ cm) uzrokuje radijalni tok. Brzina vrtnje miješala bila je 300 i 550 min^{-1} .

Tablica 1. Prikaz vrsta miješala te njihovih karakteristika
Table 1. Types of impellers and their corresponding characteristics

Vrsta miješala	Oznaka	Broj lopatica	d_m/cm	n/min^{-1}	Re	Tok
Turbinsko miješalo s lopaticama nagnutim pod kutem od 45°	T4_5_300	4	5	300	47 918	aksijalni
	T4_3,5_550	4	3,5	550	43 062	
Centrifugalno miješalo	C2_5_550	2	5	550	87 882	aksijalni
Turbinsko miješalo s 3 savinute lopatice i prstenom	P3_5_300	3	5	300	47 918	aksijalni
	P3_5_550	3	5	550	87 882	
Rushtonovo miješalo	R6_3,5_550	6	3,5	550	43 062	radijalni
	R4_3,5_550	4	3,5	550	43 062	

Određivanje širine metastabilne zone

Širina metastabilne zone određena je Nyvltovom politermalnom metodom. Priređene su otopine u rasponu koncentracija od 23 do 33 g_{sol}/100 ml_{H₂O}. Eksperimenti su provedeni u temperaturnom intervalu od 55-20 °C. Otopina se hladila brzinom od 5 °C h⁻¹ i vizualnom metodom zabilježen je početak nukleacije.

Cijepljena kristalizacija

Cijepljena kristalizacija provedena je korištenjem spomenute aparature, pri brzini vrtnje od 550 min⁻¹. Korišteno je turbinsko miješalo sa 4 lopatice nagnute pod kutom od 45° ($d_m = 3,5$ cm). Cjepivo je dodavano pri temperaturi od 43 °C pri zasićenosti otopine od 30,7 kg_{sol}/100 ml_{H₂O}.

Ukupna površina dodanog cjepiva izračunata je pomoću jednadžbi (Garside et al., 2002):

$$A_{K1} = \beta \cdot L^2 \quad (1)$$

$$N_{TOT} = \frac{m_s}{\alpha \cdot \rho_c \cdot L_a^3} \quad (2)$$

$$A_{TOT} = A_{K1} \cdot N_{TOT} \quad (3)$$

Tablica 2. Količina i veličina dodanog cjepiva te pripadajuće površine
Table. 2. Amounts and sizes of added seeds and their corresponding areas

m_s / g	$x_s / \mu\text{m}$	$A_{\text{tot}} / \text{m}^2$
1,62	178	0,164
0,26	178	0,026
0,34	106	0,058
0,21	90	0,042
0,78	268	0,052

Rezultati i rasprava

U pokušaju da se dobije unimodalna raspodjela veličina kristala ispitan je utjecaj hidrodinamičkih uvjeta korištenjem različitih vrsta miješala te promjenom brzine vrtnje miješala. Korištena su miješala koja uzrokuju aksijalni i radijalni tok strujanja kapljevine u kristalizatoru (Tablica 1).

Eksperimenti su podijeljeni u 3 dijela (uspoređivani su eksperimenti istih Re značajki) kako bi se mogli međusobno uspoređivati (Tablica 3).

Tablica 3. Srednje vrijednosti omjera duljine i širine kristala te pripadajuće vrijednosti Reynoldsove značajke

Table 3. Average value of length / breadth ratio of crystals and corresponding values of Reynolds number

Tip miješala	Re	$L_a/\mu\text{m}$	$L_b/\mu\text{m}$	L_a/L_b
T4_3,5_550	43 062	670,61	728,2	1,14
R4_3,5_550		370,17	405,68	1,2
R6_3,5_550		614,13	757,53	0,99
T4_5_300	47 918	485,84	467,2	1,30
P3_5_300		220,02	132	2,06
C2_5_550	87 882	640,02	607,52	1,6
P3_5_550		688,08	591,12	1,37

Prvi set čine eksperimenti u kojima su korištena različita miješala (turbinsko miješalo sa 4 lopatice nagnute pod kutom od 45 °C i Rushtonovo miješalo s 4 i 6 lopatica), istog promjera ($d=3,5$ cm) i brzine vrtnje miješala ($n=550$ min⁻¹), uz iste vrijednosti Re značajke ($Re=43062$).

Promjena koncentracije s temperaturom za provedene eksperimente prikazana je usporedno sa širinom metastabilne zone za sustav glicin – voda, (Slika 1a). Iako pri ovoj brzini miješanja prezasićenost nije visoka, proces se relativno dugo vrijeme provodi uz krivulju prezasićenosti što rezultira pojavom sekundarne nukleacije. U prilog tome govori dobivena višemodalna RVK (Slika 1b).

Zbog radijalnog toka uzrokovanog korištenjem *Rushtonovih* miješala, nastaju sitniji kristali. Naime, radijalni tok usmjerava kristale prema zidu kristalizatora, povećava vjerojatnost sekundarne nukleacije izazvane sudarima kristala i stijenke kristalizatora te tako djeluje na smanjeni rast kristala.

Pri blažim hidrodinamičkim uvjetima i nižim prezasićenostima, osigurani su uvjeti za rast kristala u svim smjerovima pa nastaju kompaktni kristali (Tablica 3).

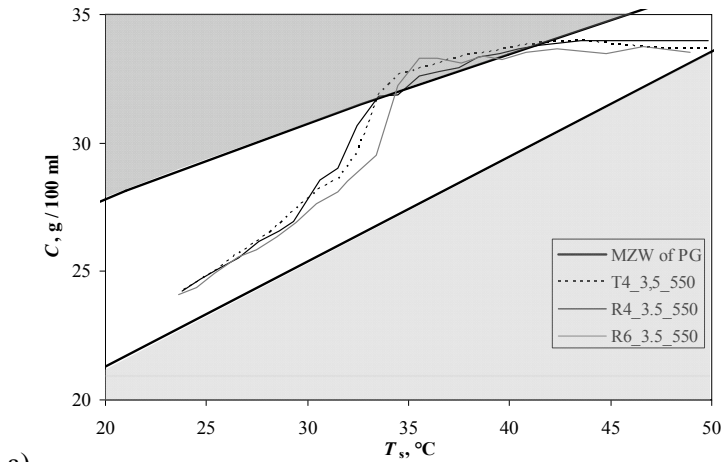

a)

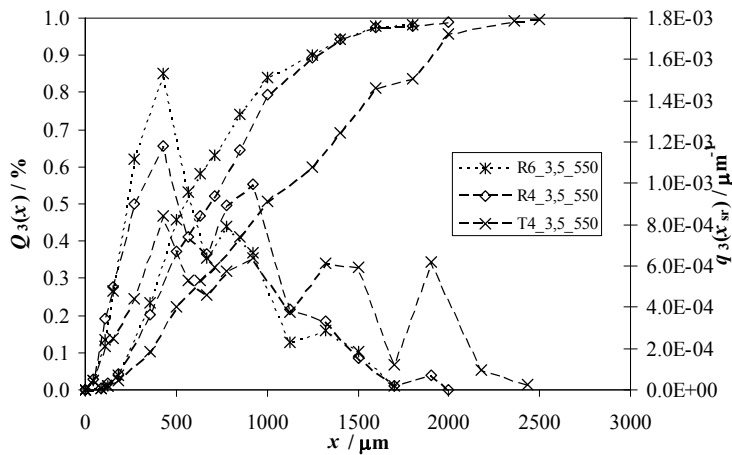

b)

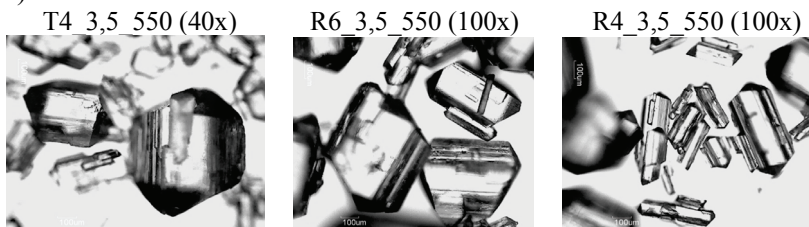

c)

Slika 1. a) Širina metastabilne zone i promjena koncentracije; b) Funkcija gustoće raspodjele i kumulativna funkcija raspodjele; c) Mikroskopska analiza kristala glicina dobivenih korištenjem turbinskog miješala sa 4 lopatice i Rushtonovih miješala sa 4 i 6 lopatica ($Re=43\ 062$)

Fig. 1. a) Metastable zone width and concentration change; b) Mass probability density function and cumulative distribution function; c) Microscope analysis of glycine crystals obtained by use of pitched bladed turbine with 4 blades and Rushton turbines with 4 and 6 blades ($Re=43\ 062$)

U drugom dijelu korištena su turbinska miješala s 3 savinute lopatice i prstenom te sa 4 lopatice uz broj okretaja 300 min^{-1} .

U eksperimentu s turbinskim miješalom sa 4 lopatice nastali kristali su mješavina velikih aglomerata i vrlo sitnih kristala izduženog oblika (Slika 2c) što rezultira višemodalnom funkcijom raspodjele (Slika 2b). Pri ovoj brzini miješanja suspenzije, nakon postizanja određene veličine, kristali se talože na dnu te se aglomeriraju. Vođenjem procesa u području viših prezasićenosti (Slika 2a) nastaje veliki broj centara nukleacije što rezultira nastankom sitnih kristala. Usporedbom dobivene RVK i određenih dimenzija pojedinačnih kristala (Tablica 1) vidljiva su određena neslaganja. Naime, RVK je dobivena prosijavanjem ukupno nastalih kristala, dok su pri mjerenju dimenzija kristala izbjegnute aglomerirane nakupine.

Korištenjem miješala s ugrađenim prstenom pri 300 min^{-1} u otopini su uočeni kristali oblika morskog ježa (Slika 2c), ali zbog njihove izrazite nestabilnosti, takav oblik nestaje nakon izdvajanja iz otopine i sušenja. Dobivena RVK pri ovakvim uvjetima je unimodalna. Pretpostavlja se da mala brzina miješanja i intenziviran aksijalni tok, kojeg uzrokuje ovo miješalo, smanjuju kontakt sa stjenkom kristalizatora i lom kristala, što sprječava sekundarnu nukleaciju.

S druge strane, brzina od 300 min^{-1} ne drži kristale u stanju dobre izmiješanosti te se velika količina slijepljenog produkta zadržavala na dnu kristalizatora i na miješalu. Ovi kristali nisu uzeti u obzir pri određivanju RVK. Podaci u Tablici 3 za ovo miješalo ukazuju na igličast oblik kristala, omjer duljine i širine $L_a/L_b > 2$.

Slično kao i u prvom setu eksperimenata, proces se vodi u neposrednoj blizini krivulje prezasićenosti. Može se reći da se povećanjem brzine vrtnje miješala od 300 do 550 min^{-1} , širina metastabilne zone sužava (Slika 3a) što je u skladu s teorijom (Myerson, 2002).

Uspoređujući kumulativne funkcije raspodjele kristala dobivenih korištenim miješalima u posljednjem setu (Slika 3b), uočava se da su kristali sitni. Kako su ovi kristali izduženog oblika (Tablica 3 i Slika 3c, $L_a/L_b > 1$), dobivena raspodjela pomaknuta je u finije područje jer je za prolazak kroz sito mjerodavna druga dimenzija kristala (L_b). Dobivene raspodjele su višemodalne, na temelju čega se može zaključiti da niti pri najvećim vrijednostima Re značajke te intenziviranom aksijalnom toku, sekundarna nukleacija nije izbjegnuta.

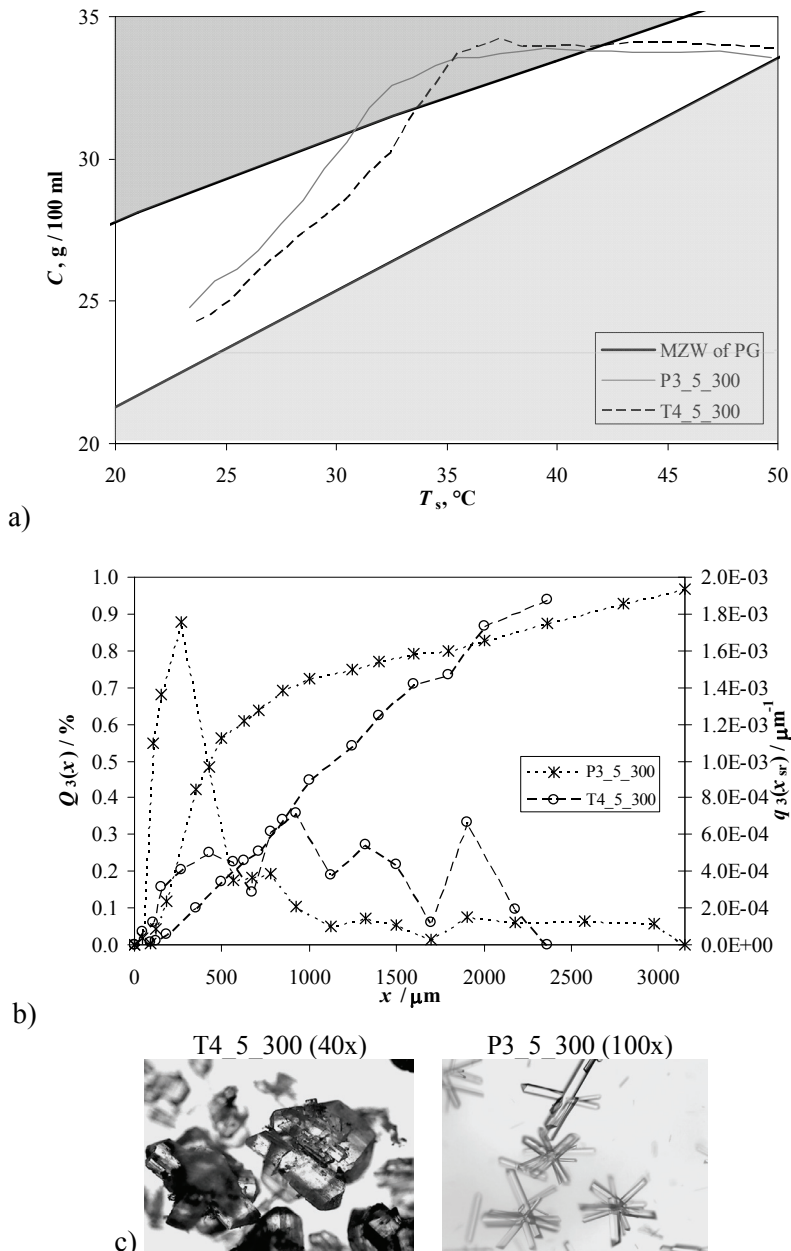

Slika 2. a) Širina metastabilne zone i promjena koncentracije; b) Funkcija gustoće raspodjele i kumulativna funkcija raspodjele; c) Mikroskopska analiza kristala glicina dobivenih korištenjem turbinskog miješala sa 4 lopatice te turbinskog miješala s 3 savinute lopatice i prstenom ($Re=47\,918$)
Fig. 2. a) Metastable zone width and concentration change; b) Mass probability density function and cumulative distribution function; c) Microscope analysis of glycine crystals obtained by use of pitched bladed turbine with 4 blades and turbine impeller with 3 declined blades and the ring ($Re=47\,918$)

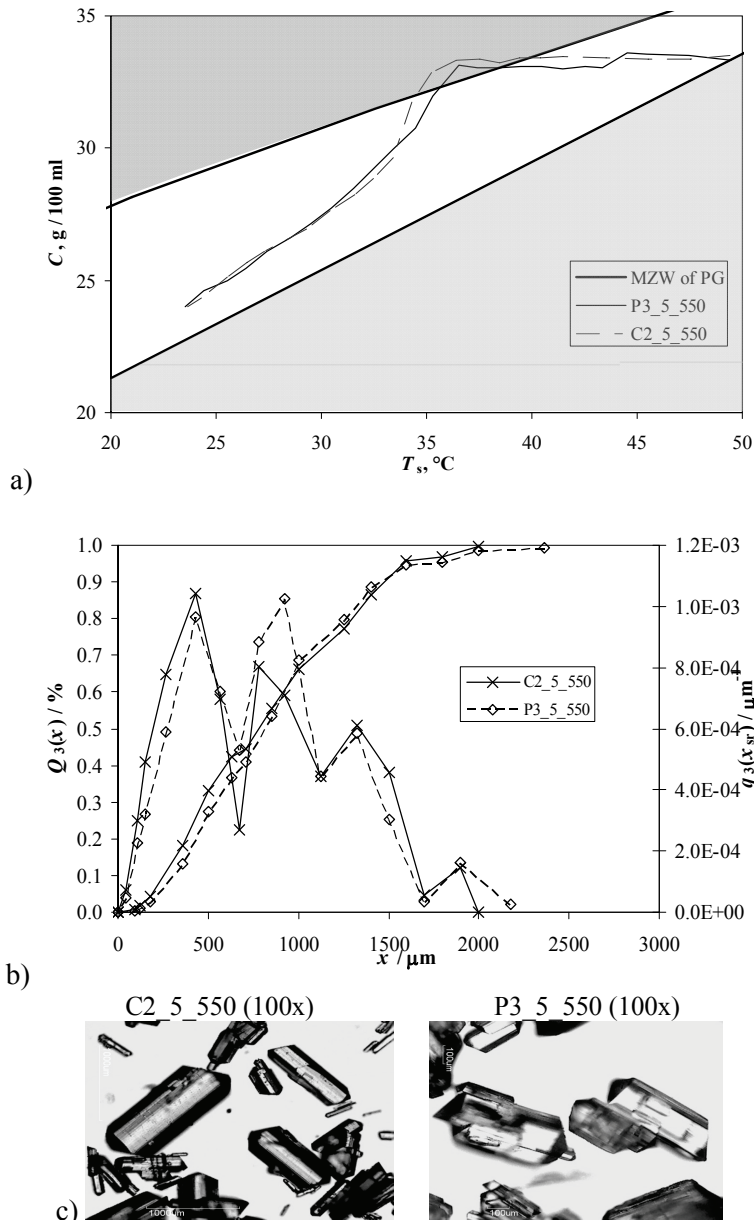

Slika 3. a) Širina metastabilne zone i promjena koncentracije; b) Funkcija gustoće raspodjele i kumulativna funkcija raspodjele; c) Mikroskopska analiza kristala glicina dobivenih korištenjem centrifugalnog miješala te turbinskog miješala s 3 savinute lopatice i prstenom ($Re=87\,882$)

Fig. 3. a) Metastable zone width and concentration change; b) Mass probability density function and cumulative distribution function; c) Microscope analysis of glycine crystals obtained by use of centrifugal impeller and turbine impeller with 3 declined blades and the ring ($Re=87\,882$)

Kako je promjenom hidrodinamičkih uvjeta teško dobiti pravilnu RVK, istražen je utjecaj dodatka cjepiva različitih veličina i masa u otopinu glicina unutar metastabilne zone. Uočava se da je cijepljenjem poboljšana raspodjela veličina kristala (Slika 5), ali i da cjepivo utječe na promjenu strukture glicina. Dodatkom cjepiva u metastabilnu otopinu, maksimalno postignuta prezasićenost otopine je niža u odnosu na prezasićenost koja se održava tijekom necijepljene kristalizacije, što pogoduje nastanku γ - oblika kristala nakon filtracije, ispiranja i sušenja (Slika 6). Također se može uočiti da je unimodalna RVK, s najizraženijim pikom, dobivena dodatkom 1,62 g cjepiva veličine 178 μm , što odgovara najvećoj površini dodanog cjepiva (Tablica 2).

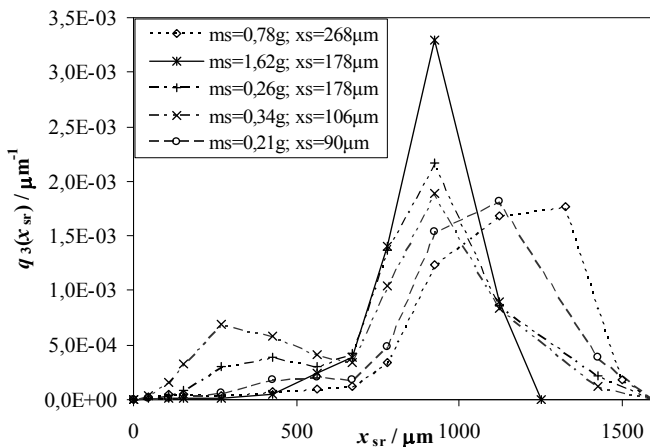

Slika 4. Funkcija gustoće raspodjele dobivene soli za različite mase dodanog cjepiva
Fig. 4. Density probability density function of obtained salt for different amounts of additives (glycine)

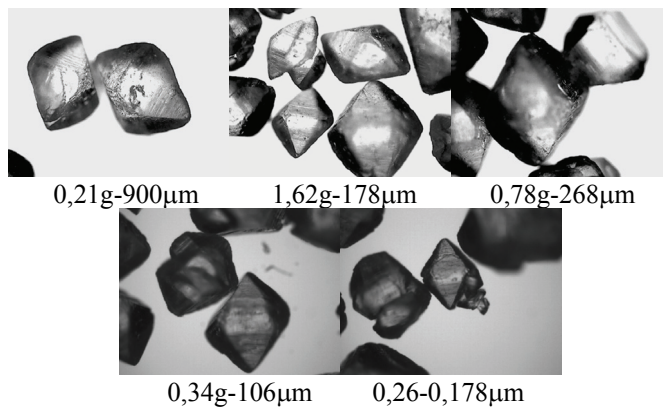

Slika 5. Mikroskopska analiza kristala glicina dobivenih uz različitu masu i veličinu dodanog cjepiva
Fig. 5. Microscope analysis of glycine crystals obtained by adding different mass and size of seeds

Zaključak

- Smanjenjem vrijednosti Reynoldsove značajke dobiveni su najkompaktniji kristali.
- Pri brzini vrtnje miješala 300 min^{-1} , postižu se visoke prezasićenosti te nastaju sitniji kristali.
- Turbinsko miješalo s tri savinute lopatice i prstenom, zbog smanjenja utjecaja radijalne komponente, reducira sekundarnu nukleaciju te se dobiva pravilna RVK, a nastali kristali su izduženi.
- Geometrija miješala koje uzrokuje intenzivirani aksijalni tok u kristalizatoru pospješit će rast izduženih kristala unatoč postignutom stupnju prezasićenosti.
- Cijepljena kristalizacija rezultira promjenom vanjskog oblika kristala te jednolikijom raspodjelom veličina.
- Dodatkom cjepiva s najvećom površinom dobivena je unimodalna RVK.

Popis simbola

A_{K1}	površina jednog kristala, m^2	$Q_3(x)$	kumulativna raspodjela veličina kristala, %
A_{TOT}	ukupna površina kristala, m^2	$q_3(x)$	funkcija gustoće raspodjele, μm^{-1}
d_m	promjer miješala, cm	T	temperatura otopine, °C
L_a	duljina kristala, μm	x	veličina kristala, μm
L_b	širina kristala, μm	x_{sr}	srednja veličina kristala, μm
L_c	duljina kristala, μm	X_{soli}	maseni odnos, $\text{kg}_{soli}/\text{kg}_{otapala}$
L_s	duljina cjepiva, μm	α	volumni faktor oblika
L_{sr}	srednja duljina kristala, μm	β	površinski faktor oblika
m_c	masa kristala, g	ρ_c	gustoća kristala, kgm^{-3}
m_s	masa cjepiva, g		
N_{TOT}	ukupni broj kristala		

Literatura

- Baran, J., Ratajczak, H. (2005): Polarised IR and Raman spectra of the γ -glycine single crystal, *Spectrochimica Acta Part A*. 61, 1611-1626.
- Bouchard, A., Jovanović, N., Hofland, G.W., Crommelin, D.J.A., Jiskot, W., Witkamp, J. (2008): Ways of manipulating the polymorphism of glycine during supercritical fluid crystallisation, *Journal of Supercritical Fluids*. 44, 422-432.
- Dhanaraj, P.V., Rajesh, N.P. (2009): Growth and Characterization of Nonlinear Optical γ - Glycine Single Crystal from Lithium Acetate as Solvent, *Materials Chemistry and Physics*. 115, 413-417.
- Ferreira, L.A., Macedo, E.A., Pinho, S.P. (2004): Solubility of Amino Acids and Diglycine in Aqueous-Alkanol Solutions, *Chem Eng. Sci.* 59 (15), 3117-3124.
- Garside, J., Mersmann, A., Nyvlt, J. (2002): Measurement of Crystal Growth and Nucleation Rates, Institution of Chemical Engineers, Manchester, GB

- Hamond, R.B., Ramachandran, V., Roberts, K.J. (2008): Molecular Modeling to Investigate the Effect of L-alanine on the Crystal Growth of α -Glycine. In: *17th International Symposium on Industrial Crystallization*, Maastricht, Netherlands
- He, G., Bhamidi, V., Wilson, S.R., Tan, R.B.H., Kenis, P.J.A., Zukoski, C.F. (2006): Direct Growth of γ -Glycine from Neutral Aqueous Solutions by Slow Evaporation-Driven Crystallization, *Crystal Growth and Design*. 6, 1746-1749.
- Moscosa-Santillán, M., Bals, O., Fauduet, H., Porte, C., Delacroix, A. (2000): Study of Batch Crystallization and Determination of an Alternative Temperature-Time Profile by On-Line Turbidity Analysis — Application to Glycine Crystallization, *Chem. Eng. Sci.* 55 (18), 3759-3770.
- Myerson, A.S. (2002): Handbook of Industrial Crystallization, Butterworth-Heinemann, Boston, USA
- Murli, C., Sharma, S.M., Karmakar, S., Sikka, S.K. (2003): α -Glycine Under the High Pressures: a Raman Scattering Study, *Physica B*. 339, 23-30.
- Srinivasan, K. (2008): Morphology and Properties of Glycine Polymorphs. In: *17th International Symposium on Industrial Crystallization*, Maastricht, Netherlands
- Yang, H., Liu, W., Black, S., Wei, H. (2008): Effect of Additives on Polymorph and Morphology of Glycine Crystals. In: *17th International Symposium on Industrial Crystallization*, Maastricht, Netherlands

The possibility of obtaining unimodal size distribution of glycine crystals

M. Hrkovac, J. Prlić Kardum, A. Sander

University of Zagreb, Faculty of Chemical Engineering and Technology, Marulićev trg 20, 10000 Zagreb, Croatia

Summary

In order to obtain unimodal size distribution of glycine crystals from batch cooling crystallization, the influence of the hydrodynamic and seeding conditions has been investigated. Different types and dimensions of impellers and mixing rates were used. Four types of impellers that generate different flows in the crystallizer have been selected: turbine impeller ($d_m = 5$ cm), Rushton turbine (4 and 6 blades; $d_m = 3,5$ cm), centrifugal impeller ($d_m = 5$ cm) and pitched blade turbine downpumping ($d_m = 3,5$ i 5 cm). Agitation rate was 300 and 550 rpm. On the other hand, if solution was mixed with the turbine impeller, unimodal crystal size distribution is obtained. Turbine impeller enhances axial flow in the crystallizer. The influence of the seed mass and size added to the solution within the metastable zone was also investigated. During seeded crystallization solution is at a relatively low supersaturation. Consequently, final crystal size distributions were improved and the crystal shape was changed. The bigger seed size and higher seed loadings lead to a unimodal size distribution of the final crystals.

Keywords: glycine, hydrodynamic conditions, mixing, seeded crystallization

Efficiency of the rinsing agent on the reduction of B₂O₃ mass fraction in magnesium oxide from seawater

UDC: 551.464.6 : 661.846.22

V. Martinac*, M. Labor, J. Jakić

University of Split, Faculty of Chemistry and Technology, Teslina 10/V, 21000 Split, Croatia

Summary

This study investigates the combined method of rinsing the magnesium hydroxide precipitate (3+2) in which, in the decanting process, the alkalisied distilled water with pH = 12.50 is used in the first phases of rinsing, followed by fresh distilled water with pH = 5.30. At repeated rinsing on filter paper (up to three times) the alkalisied distilled water with pH = 12.5 and/or combined way of rinsing (2+3) is applied, i.e. after the precipitate has been rinsed 2 times by alkalisied distilled water, it is rinsed with fresh distilled water (up to 3 times). The purpose of the study is to establish the efficiency of these methods of rinsing the seawater-derived magnesium hydroxide precipitate on the reduction of primarily mass fraction of boron (III) oxide in calcined magnesium oxide, since the properties of seawater-derived high-temperature sintered magnesium oxide are greatly affected by the B₂O₃ fraction. This work contributes to the efficiency improvement of the rinsing procedure of magnesium hydroxide precipitate and points at the procedure development considering the order of use of rinsing agent in combined procedure. The experimental results indicate that it is sufficient to perform the rinsing on filter paper by alkalisied distilled water with pH = 12.50 two times. By this method of rinsing the total reduction of the B₂O₃ fraction is approx. 61 % relative to the B₂O₃ fraction in the samples prepared without rinsing the magnesium hydroxide precipitate (B₂O₃ = 0.2533 mass %). If the combined method of rinsing (2+3) on filter paper is applied, the mass fraction of B₂O₃ in calcined magnesium oxide is reduced by approx 69 % relative to the not-rinsed sample.

Keywords: magnesium oxide, rinsing agent, mass fraction B₂O₃, substoichiometric precipitation

Introduction

Technological process of deriving magnesium oxide from seawater takes a significant position among other chemical processes for obtaining it (Bonney, 1982; Carson, 1994; Heasman, 1979; Petric B., 1980; Shand, 2006). Seawater can be efficiently used as the raw material for obtaining magnesium oxide if it contains magnesium used in mass concentration of at least 1.3 g dm⁻³.

* martinac@ktf-split.hr

Magnesium is found in seawater in the form of soluble salts $MgCl_2$ and $MgSO_4$ and it is separated by precipitating the insoluble magnesium hydroxide by adding the alkaline base such as dolomite lime or limestone lime. The precipitate is being rinsed and calcined to form caustic magnesia. While the chemical reactions involved are relatively simple, the engineering processes, required to perform the reactions in the way that they result in easily precipitated magnesium hydroxide, can be complicated and careful study is needed to select the optimal sequence of operations.

Boron (Brown, 1997) contained in seawater (4.4 mg dm^{-3}) represents a great problem. Boron is found in seawater in the form of undissociated orthoboric acid (H_3BO_3), and partly in the form of borate ions (primarily $H_2BO_3^-$, and to a much lower extent HBO_3^{2-} and BO_3^{3-}) and it adsorbs onto the magnesium hydroxide precipitate during precipitating. Boron is a particularly bad blend in magnesium oxide if it is used as a refractory special-purpose material where high hot strength is required. Yet, by applying specific reaction conditions, the content of boron can be significantly reduced. This work investigated the carefully controlled conditions while magnesium hydroxide was being rinsed in the procedure of decantation, as well as on filter paper.

The stated working conditions have not been described in literature. The utilized magnesium oxide was obtained by sub-stoichiometric precipitation process with the addition of 80 % the stoichiometrically required quantity of dolomite lime as the precipitation agent.

The stated investigations were carried out with the aim of improving the technological process in order to obtain the calcined magnesium oxide with the least possible content of B_2O_3 , i.e. with the minimal content of boron (III) oxide in magnesium oxide.

Experimental part

The mass concentration of calcium oxide and magnesium oxide in seawater used for precipitation of magnesium hydroxide was as follows:

$$\gamma(MgO) = 2.375 \text{ g dm}^{-3}; \quad \gamma(CaO) = 0.583 \text{ g dm}^{-3}$$

Dolomite lime, used as the precipitation agent, had the following mass composition:

$$MgO = 42.27 \% ; CaO = 57.17 \% ; SiO_2 = 0.099 \% ; Fe_2O_3 = 0.079 \% \text{ and } Al_2O_3 = 0.051 \%$$

The seawater used for obtaining magnesium oxide was taken at the location of the Oceanographic Institute of Split, while the dolomite originated from the Đipalo – Sinj location.

After having analyzed the seawater for calcium and magnesium, the seawater was pre-treated by acidifying it with sulphuric acid until pH = 3.8 – 4.0 in order to remove the carbonate and hydrogen carbonate ions present in seawater. The reactions are as follows:

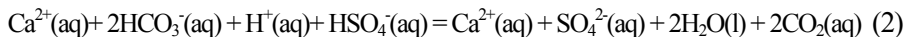
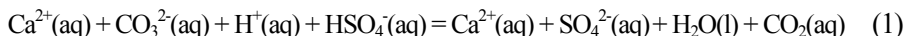

The carbon dioxide formed remains dissolved in seawater and can react after the reaction:



causing the pollution of magnesium hydroxide precipitate with calcium carbonate. Because of that the formed carbon dioxide was removed by counter-current blowing with compressed air in a desorption tower. The volume flow rate of the compressed air was $Q = 120 \text{ dm}^3 \text{ h}^{-1}$, and the volume flow rate of the seawater was $Q = 0.6 \text{ dm}^3 \text{ h}^{-1}$.

The pre-treatment was followed by precipitation with dolomite lime, with 80 % of the stoichiometrically required quantity in this case. The precipitation process can be represented by the equation:

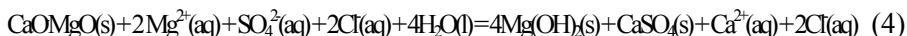

The precipitation reaction lasted for 30 minutes, along with mixing on the magnetic stirrer.

Precipitation was followed by sedimentation of magnesium hydroxide. To improve the sedimentation rate, we used the anionic 818A flocculent (polyacrylamide) produced by the Dutch company Hercules. The procedure of determination of the optimal quantity of the 818A flocculent has been described in this paper (Petric N., 1999). This was followed by decanting and rinsing of the magnesium hydroxide precipitate.

The following rinsing agents were used:

- alkalisated distilled water with pH of 12.50 (the alkalisating agent was concentrated NaOH p.a.) and
- distilled water with pH of 5.30

At rinsing by decanting, the 3+2 combined rinsing method was applied, i.e. the magnesium hydroxide was rinsed three times by alkalisated distilled water with pH of 12.50, and then two times by fresh distilled water with pH of 5.30. The volume of the rinsing agent was approx. 1 dm^3 . The precipitate mass during the

rinsing by decanting was 7.708 g. Decanting was followed by filtering on a number of funnels (blue ribbon filter paper). The precipitate on filter paper was rinsed by alkalisated distilled water with pH of 12.50 (up to three times) and/or the (2+3) combined rinsing method was used where the precipitate was rinsed twice by alkalisated distilled water and then by fresh distilled water (up to three times).

In order to determine the efficiency of working conditions and method of rinsing of magnesium hydroxide precipitate, the precipitate was collected after each process of filtering for further analysis. The obtained samples of magnesium hydroxide, which differed among themselves by the way of rinsing the magnesium hydroxide precipitate after the process of filtering, were dried at 105 °C, and then calcined at 950 °C within 5 hours to form caustic magnesia.

The boron content in the examined magnesium oxide samples was determined by potentiometric titration. The procedure was as follows: 4.0000 g of the magnesium oxide sample was weighed, transferred to a 600 cm³ glass and dissolved by addition of the HCl (1:1) solution. The precipitate was being heated until it dissolved. The glass is then filled up with distilled water to the volume of 200 cm³, and the solution was cooked to remove CO₂.

The sample was cooled to the room temperature on a water bath. The glass was covered to prevent the effect of atmospheric CO₂. During potentiometric titration, the solution was being mixed on a magnetic stirrer. 3 mol dm⁻³ NaOH was used for neutralisation until pH was approx. 5.00, then 0.0231 mol dm⁻³ NaOH was being added until pH 7.00 was reached. If the addition of alkali results in pH exceeding 7.00, then HCl (1:1) is added to reduce pH to ≤ 7.00. The neutralisation was monitored through changes in pH on a pH-meter (the MA-5737 type), using the combined electrode and temperature probe Pt-100 to compensate for temperature changes during titration. At the initial titration point (pH = 7.00), 5.0 g (± 0.1 g) mannitol was added. Titration continued with 0.0231 mol dm⁻³ NaOH until the initial titration point was attained again. The number of cm³ of the standard alkali solution was being recorded, after the addition of mannitol in the initial titration point. The variation coefficient (Culkin, 1975) for this method was ± 1 %.

Results and Discussion

Table 1 shows the results obtained for determination of the B₂O₃ content in the samples examined, as well as the working conditions of rinsing of the magnesium hydroxide precipitate.

Table 1. Working conditions applied in rinsing the magnesium hydroxide precipitate and the B₂O₃ content in magnesium oxide after calcination at 950 °C/5 h

Sample number	Rinsing agent	Number of rinses by decanting	B ₂ O ₃
			mass %
1.	Alkalised distilled water (pH = 12.50) + Distilled water (pH = 5.30)	3+2	0.1244
2.	Alkalised distilled water (pH = 12.50)	Number of rinses on filter paper	B ₂ O ₃
			mass %
		1.	0.1073
		2.	0.0998
3.		3.	0.0994
4.			
5.	Alkalised distilled water (pH = 12.50) + Distilled water (pH = 5.30)	2+1	0.0995
6.		2+2	0.0958
7.		2+3	0.0785
8.		No rinsing of precipitate	-

The examination results indicate that if the magnesium hydroxide precipitate, obtained by sub-stoichiometric precipitation with 80 % of the stoichiometrically required quantity of dolomite lime (the precipitate agent), is not rinsed, it contains the increased B₂O₃ content, amounting to 0.2533 mass %.

Although the previous investigations (Petric B., 1980; Petric N., 1999) pointed at considerable advantages of sub-stoichiometric (80 %) way of magnesium hydroxide precipitating from seawater in so called wet phase, the increased adsorption of ionic forms of boron (primarily H₂BO₃⁻) on the magnesium hydroxide precipitate during the reaction of precipitating (as shown in reaction (4)), results in its contamination and also in the increase of boron (III) oxide content in the calcined magnesium oxide.

The increased content of the adsorbed boron on the magnesium hydroxide precipitate at sub-stoichiometric precipitating is the consequence of the decrease of pH value of magnesium hydroxide suspension. By adding the sub-stoichiometric (80 %) quantity of dolomite lime to seawater, with the purpose of precipitating the magnesium hydroxide, the alkalinity of seawater amounts 9.6. Calculating the percentage of dissociation, one can establish the amount molar concentration of ionic forms of boron, as well as the molar percentage of dissociation for each dissociation degree of orthoboric acid. At pH the H₃BO₃ dissociated around 70 %, while the concentration of HBO₃²⁻ and BO₃³⁻ was very low.

Therefore, the investigation and establishing the optimal way of rinsing of the magnesium hydroxide precipitate is of primary importance, so that the quality of final product may be kept on satisfactory level.

This work represents the resumption of our investigations (Martinac, 2006, 2004, 2002, 2001) in finding out the appropriate solution.

Previous investigations (Martinac, 2002, 2001) have shown that the increase of pH of rinsing agent diminishes the content of the adsorbed boron (expressed as B_2O_3) on the seawater-derived magnesium hydroxide precipitate and that in the process of decantation (Martinac, 2006) the number of rinsing procedures should not be more than three.

The investigated combined methods (Martinac, 2004), in which distilled water was applied in the early phases of rinsing procedures, and then alkalized distilled water with the increased pH value, contribute to the decrease of B_2O_3 content in calcined magnesium oxide up to 39 %.

In order to significantly increase the percentage of B_2O_3 reduction in seawater-derived calcined magnesium oxide by sub-stoichiometric (80 %) precipitating, in this work we investigated the efficiency of combined ways of rinsing procedures in which in the first phases of rinsing procedures we used, as in the process of decantation so too after filtration, the alkalized distilled water with pH value of 12.50, and then the fresh distilled water with pH value of 5.30. The rinsing procedure described in this work has not been investigated so far.

If the combined method of rinsing the magnesium hydroxide precipitate is used in the (3+2) decanting process, where alkalised distilled water with pH of 12.50 (sample 1) has been used in the first phases of rinsing, the B_2O_3 content is significantly reduced, and amounts to 0.1244 mass %, i.e. it is by 51 % lower than the B_2O_3 content in the samples prepared without rinsing the magnesium hydroxide precipitate.

If the (3+2) combined rinsing method by decanting is followed by one-time rinsing by alkalised distilled water with pH of 12.50 on filter paper, the B_2O_3 content is reduced even more. In this case the B_2O_3 content (sample 2) amounts to 0.1073 mass %, i.e. it is by approx 14 % lower than that in sample 1. This rinsing method results in a 58 % reduction of B_2O_3 content relative to the sample that has not been rinsed. The high pH value of the rinsing agent (12.50) favourably affects the desorption of boron ionic forms from the surface of the magnesium hydroxide precipitate, because small, negatively charged OH^- ions, which are in excess, primarily adsorb to the magnesium hydroxide precipitate in a highly alkaline medium, thereby preventing further contamination of MgO with boron.

Increasing the number of rinsing by alkalised distilled water with pH of 12.50 on filter paper to two or three times (samples 3 and 4 respectively) further reduces the B_2O_3 content by 7 % ($B_2O_3 = 0.0998$ %) relative to the B_2O_3 content in sample 2. It is evident that further rinsing with alkalised distilled water with pH of 12.50 on filter paper (sample 4) does not contribute to a significant reduction of the B_2O_3 content in the calcined magnesium oxide. The results obtained indicate that the number of rinses by alkalised distilled water on filter paper should not exceed two. The described rinsing method results in an overall reduction of the B_2O_3 content of 61 % relative to the B_2O_3 content in samples prepared without rinsing the magnesium hydroxide precipitate (sample 8). The results obtained indicate that the combined rinsing method should be used on

filter paper as well, i.e. after rinsing with alkalisated distilled water two times, rinsing should be continued by fresh distilled water. Therefore, this study investigated the combined rinsing method on filter paper (2+1, 2+2, and 2+3) to determine how and to what extent additional rinsing with fresh distilled water affects the reduction of the B₂O₃ content. The purpose of these investigations was to establish the optimal conditions for rinsing the seawater-derived magnesium hydroxide precipitate.

The study results indicate that the combined method of rinsing of the magnesium hydroxide precipitate on filter paper is more efficient (samples 5, 6, and 7) than rinsing only with alkalisated distilled water (samples 2, 3, and 4), and that it contributes to a significant reduction of B₂O₃ content in the calcined magnesium oxide.

When applying the combined method of rinsing of the magnesium hydroxide precipitate on filter paper, the (2+3) method is evidently the most favourable as it contributes to the overall reduction of the B₂O₃ content by 69 % relative to the B₂O₃ content in samples prepared without rinsing the magnesium hydroxide precipitate.

In this case the B₂O₃ content (sample 7) was reduced by 21 % relative to the B₂O₃ content in sample 4.

Conclusions

- The combined rinsing method 3+2, where alkalisated distilled water (pH = 12.50) is used in the first phases of rinsing and then fresh distilled water (pH = 5.30), followed by several rinses (up to three times) by alkalisated distilled water with pH of 12.50 and on filter paper, contributes to the overall reduction of the B₂O₃ content in MgO samples (80 % precipitation) in the range from 0.2533 mass % to 0.0994 mass %, i.e. the B₂O₃ content is reduced by 61 %.
- Multiple rinses on filter paper with alkalisated distilled water with pH of 12.50 should not exceed three rinses.
- When combined rinsing method is used on filter paper as well, the B₂O₃ content in calcined magnesium oxide is significantly reduced.
- The combined method of rinsing (2+3) on filter paper is the most favourable one as it contributes to the overall reduction of the B₂O₃ content by 69 % relative to the B₂O₃ content in samples prepared without rinsing of the magnesium hydroxide precipitate.
- This work contributes to the efficiency improvement of rinsing method of magnesium hydroxide precipitate and points at the procedure development regarding the order of use of rinsing agent in combined method.

References

- Bonney, O. V. (1982): Recovery of magnesium as magnesium hydroxide from seawater, US Pat. 43 149 85 (to Amstar Corporation, New York), 9 Feb. 1982, *Chem. Abst.* 96, 125549.
- Brown E. et al. (1997): Seawater: Its compositions, properties and behaviour, 2nd Ed., Milton Keynes, Walton Hall, Butterworth Heinemann in association with The Open University, pp.104.
- Carson, R. C. and Simandl, J. (1994): Kinetics of magnesium hydroxide precipitation from seawater using slaked dolomite, *Mineral. Eng.* 7, 511-517.
- Culkin, F. (1975): The major constituents of seawater. In: Chemical Oceanography, Vol.1, Riley, J. P., Skirrow, G. (ed.), London, GB: Academic Press, pp.136-151.
- Heasman, N. (1979): New developments in seawater magnesia, *Gas wärme International.* 28, 392-397.
- Martinac, V., Petric, N., Labor, M. (2006): B₂O₃ and CaO in magnesium oxide from seawater, *Mater. Technol.* 40, 65-68.
- Martinac, V., Petric, N., Labor, M. (2004): Boric oxide in seawater derived magnesia, *Indian J. of Mar. Sci.* 33 (9), 226-230.
- Martinac, V., Petric, N., Labor, M. (2001): An examination of B₂O₃ in magnesium oxide obtained from seawater, *Mater. Technol.* 35, 113-116.
- Martinac, V., Petric, N., Labor, M. (2002): The effect of the pH of the rinsing solution on the properties of magnesium oxide from seawater, *Mater. Technol.* 9, 395-399.
- Petric, B. and Petric, N.(1980): Investigations of the rate of sedimentation of magnesium hydroxide obtained from seawater, *Ing. Eng. Chem. Des. Dev.* 19, 329-335.
- Petric, N., Martinac, V., Labor, M., Jurin, O.(1999): Effect of 818A and 827N flocculants on seawater magnesia process, *Kovine Zlitine Tehnologije* 33, 473-478.
- Shand, M. A. (2006): The Chemistry and Technology of Magnesia, New York, USA: Wiley, 39-61.

Anodno ponašanje aluminija u kloridnoj otopini

UDC: 669.71 : 543.5

I. Smoljko, S. Gudić*, D. Jović

Sveučilište u Splitu, Kemijsko-tehnološki fakultet, Zavod za elektrokemiju i zaštitu materijala, Teslina 10/V, 21000 Split, Hrvatska

Sažetak

U radu je ispitano anodno ponašanje super čistog aluminija (99,999 %) i aluminija tehničke čistoće (99,8 %) u 2 mol dm⁻³ NaCl otopini pri 25, 35 i 45 °C. Uzorci su polarizirani različitim anodnim gustoćama struje (od 100 do 500 mA cm⁻²) kroz vrijeme od 15 minuta. Tijekom anodne polarizacije snimani su potencijal–vrijeme odgovori, mjerena je volumena vodika koji se izlučivao s površine uzoraka te određen gubitak mase. Po završetku mjerenja, površine uzoraka mikroskopski su analizirane i fotografirane. Ustanovljeno je da kod svih primijenjenih anodnih gustoća struje dolazi do istovremenog otapanja aluminija i izlučivanja vodika. Što je anodna gustoća struje veća, veća je brzina otapanje metala, ali i brzina izlučivanja vodika (pojava negativnog diferencijalnog efekta - NDE). Nadalje, provedena istraživanja pokazuju da prisutne nečistoće ne utječu na anodno ponašanje aluminija u kloridnoj otopini. Za oba ispitivana uzorka dobivene su iste vrijednosti NDE ($\approx 0,17$) i anodne djelotvornosti ($\approx 86\%$), što ukazuje na činjenicu da se umjesto super čistog aluminija za izradu anoda u Al/zrak kemijskim izvorima struje može koristiti jeftiniji i dostupniji aluminij tehničke čistoće. Temperatura otopine ne utječe na brzinu izlučivanja vodika. Međutim, povećanje temperature negativno utječe na anodnu djelotvornosti oba uzorka aluminija.

Ključne riječi: aluminij, anodna djelotvornost, negativni diferencijalni efekt

Uvod

Posljednjih godina ističe se mogućnost uporabe aluminija i njegovih slitina za skladištenje i konverziju energije (Al/zrak baterije) (Real i sur., 1988; Li i sur., 2002; Yang i sur., 2002; Ferrando, 2004; Nestoridi i sur., 2008). Al/zrak baterije prvenstveno su se razvijale za uporabu u vojne svrhe kao izvor električne energije u svemirskim brodovima, električnim vozilima (Yang i sur., 2002) te u podmornicama (Ferrando, 2004). Danas se istraživanja usmjeravaju na mogućnost uporabe Al/zrak baterija u industriji prijenosnih računala te mobilnih i medicinskih uređaja.

Teorijski gledano Al/zrak kemijski izvor struje ima energetska kapacitet od 2980 Ah kg⁻¹ i napon od 2,70 V. Međutim, smetnju pri ostvarivanju ovih teorijskih mogućnosti predstavlja oksidni sloj koji je gotovo uvijek prisutan na površini Al, što dovodi do

* senka@ktf-split.hr

značajnih gubitaka raspoložive energije. Ovo je usporilo razvoj praktičnih sustava baterija Al/zrak i ograničilo njihovu komercijalnu primjenu.

Sprječavanje sporednih reakcija (pasivacije, samokorozije, izlučivanja vodika) uz istovremeno održavanje elektrokemijske aktivnosti anodnog metala jedan je od ključnih problema koji treba riješiti kako bi se postiglo zadovoljavajuće iskorištenje energije u baterijama Al/zrak. Legiranjem aluminija malim količinama elemenata koji imaju visoki prenapon izlučivanja vodika (Hg, Mg, Zn, Ga, Sn, In, Cd, Bi) uklanjaju se osnovni nedostaci te se pospješuje anodna aktivnost aluminija (Despić i sur., 1976; Tuck i sur., 1987; Real i sur., 1988; Dražić i sur., 1999; Li i sur., 2002).

Da bi se Al/zrak baterije učinile što ekonomičnije, u posljednje vrijeme ispituju se mogućnosti izrade anoda od jeftinijeg i dostupnijeg aluminija tehničke čistoće. U ovom radu ispitano je anodno ponašanje super čistog i tehničkog aluminija u NaCl otopini pri različitim temperaturama.

Materijali i metode

Mjerenja su provedena na super čistom aluminiju (99,999 %, Al(5N)) i aluminiju tehničke čistoće (99,8 %, Al(teh.)) u 2 mol dm⁻³ NaCl otopini pri različitim temperaturama (25, 35 i 45 °C).

Prije svakog mjerenja radna površina elektrode (0,5 cm²) je mehanički i kemijski obrađivana (brušenje brusnim papirima različite finoće te tretiranje s 0,1 mol dm⁻³ otopinom NaOH).

Pri izvođenju elektrokemijskih mjerenja korišten je potenciostat (PAR model 273A) te standardni stakleni reaktor sastavljen od radne elektrode, protuelektrode (Pt) i referentne elektrode (ZKE). Dupla stjenka reaktora omogućavala je održavanje otopine elektrolita na željenoj temperaturi. Tijekom mjerenja radna elektroda se nalazila ispod staklenog zvona, na koje je bila postavljena bireta. U bireti se sakupljao izlučeni vodik.

Primjenom galvanostatičke pulsne metode uzorci su polarizirani različitim anodnim gustoćama struje (od 100 do 500 mA cm⁻²) kroz vrijeme od 15 minuta. Tijekom anodne polarizacije snimani su potencijal-vrijeme odgovori i mjeren volumen vodika koji se izlučivao s površine uzorka. Gravimetrijskom metodom, tj. vaganjem elektroda neposredno prije i poslije anodne polarizacije određen je gubitak mase pri anodnom otapanju uzoraka. Nakon mjerenja, površine uzoraka mikroskopski su analizirane korištenjem optičkog mikroskopa tipa Citoval (Carl Zeiss Jena) pri uvećanju od 100 puta.

Rezultati i rasprava

Pri anodnoj polarizaciji aluminija, kao paralelna reakcija otapanju metala javlja se reakcija izlučivanja vodika, što se inače događa kod svih metala čiji su standardni elektrodni potencijali negativniji od vodikove elektrode. Kod većine ovih metala, povećanjem anodne polarizacije smanjuje se brzina izlučivanja vodika te kod većih

potencijala (bliskih ili pozitivnijih od standardnog elektrodnog potencijala vodika) gotovo prestaje. Ova je pojava u literaturi poznata kao "pozitivni diferencijalni efekt" i odražava normalno ponašanje prema Wagner-Traudovoj teoriji o elektrokemijskoj koroziji metala.

Nasuprot navedenom, u otopinama koje sadrže agresivne anione (Cl^- , Br^- , F^-) aluminij se značajno otapa, a povećanjem anodne struje povećava se i brzina izlučivanja vodika, što je u literaturi poznato kao "negativni diferencijalni efekt" (NDE) (Despić i sur., 1976; Dražić i sur., 1999). Slično ponašanje je uočeno i kod nekih drugih metala, kao što su Mg, Be na čijim je površinama također prisutan oksidni film (Weber i sur., 2003).

Ekperimentalno je ustanovljeno da se povećanjem anodne struje, i , linearno povećava i brzina izlučivanja vodika, i_{H_2} , pri čemu je: $i \approx ki_{\text{H}_2}$. Konstanta proporcionalnosti, k , ovisi o eksperimentalnim uvjetima, osobito o kemijskom sastavu metala, a vrijednost joj se kreće u granicama od 0,01 do 0,20 (Despić i sur., 1976; Dražić i sur., 1999; Weber i sur., 2003).

Anodno ponašanje super čistog aluminija te aluminija tehničke čistoće u NaCl otopini pri 25 °C ispitano je galvanostatičkom metodom. Elektrode izrađene od navedenih materijala polarizirane su različitim anodnim gustoćama struje (od 100 do 500 mA cm^{-2}) kroz vrijeme od 15 minuta, pri čemu su registrirane krivulje ovisnosti potencijala o vremenu prikazane na Slici 1.

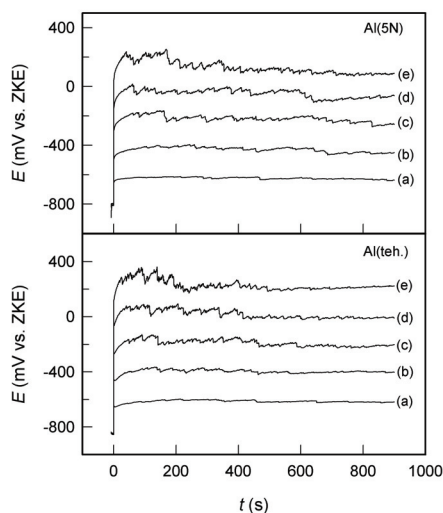

Slika 1. Potencijal – vrijeme odgovori snimljeni na čistom i tehničkom Al u 2 mol dm^{-3} NaCl otopini ($T=25\text{ }^\circ\text{C}$) kod različitih gustoća struje: (a) 100, (b) 200, (c) 300, (d) 400 i (e) 500 mA cm^{-2}

Fig. 1. Potential-time responses recorded for pure and technical Al in 2 mol dm^{-3} NaCl solution at different current densities: (a) 100, (b) 200, (c) 300, (d) 400 and (e) 500 mA cm^{-2}

Nagli porast potencijala, primijećen u početnom dijelu dobivenih krivulja posljedica je nabijanja elektrokemijskog dvosloja zbog polarizacije elektrode (prvih nekoliko ms). Nakon nabijanja dvosloja odvija se reakcija otapanja aluminija te se na elektrodama uspostavlja stacionarna vrijednost potencijala. Što je anodna gustoća struje veća, stacionarni potencijal pojedine elektrode također je veći (Slika 2).

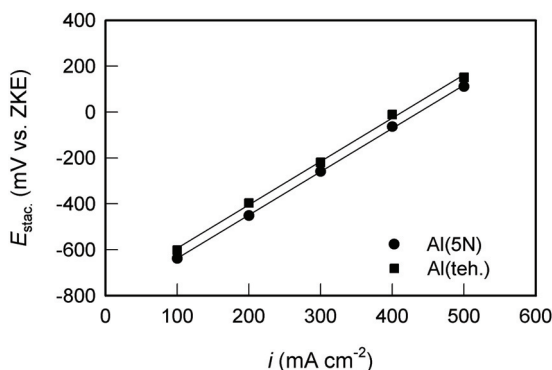

Slika 2. Ovisnost stacionarnog potencijala o anodnoj gustoći struje za čisti i tehnički Al u 2 mol dm⁻³ NaCl otopini pri 25 °C

Fig. 2. Dependence of steady state potential on the anodic current density for pure and technical Al in 2 mol dm⁻³ NaCl solution at 25 °C

Vrijednosti potencijala koji se uspostavljaju na čistom Al negativnije su od vrijednosti dobivenih za Al tehničke čistoće (za ≈ 50 mV), što ukazuje na činjenicu da se aktivno otapanje čistog Al odvija pri nižim polarizacijama elektrode.

Tijekom anodne polarizacije (kod različitih gustoća struje), svake minute mjeren je volumen vodika koja se izlučivao s površine čistog i tehničkog Al. Dobiveni rezultati prikazani su na Slici 3.

Vidljivo je da volumen vodika linearno raste s vremenom polarizacije. Što je gustoća struje veća, veći je i volumen izlučenog vodika.

Potrebno je naglasiti da su vrijednosti potencijala galvanostatički polariziranih elektroda u NaCl otopini (Slika 1 i 2) znatno pozitivnije od vrijednosti ravnotežnog potencijala vodikove elektrode te pri ispitivanim anodnim gustoćama struje nije moguće katodno izlučivanje vodika.

Međutim, kao što je objašnjeno u daljnjem tekstu, otapanje aluminija se po svojoj prilici odvija u dva stupnja, najprije nastaje Al⁺ ion koji se dalje oksidira do Al³⁺ ion, a izlučivanje vodika dominantno je posljedica kemijske reakcije Al⁺ iona s vodom (Despić i sur., 1976).

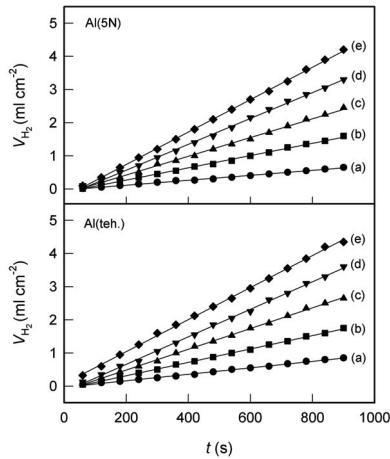

Slika 3. Vremenska ovisnost volumena izlučenog vodika na čistom i tehničkom Al u 2 mol dm⁻³ NaCl ($T=25\text{ }^{\circ}\text{C}$) kod različitih gustoća struje: (a) 100, (b) 200, (c) 300, (d) 400 i (e) 500 mA cm⁻²
Fig. 3. Dependence of hydrogen evolution volume on time for pure and technical Al in 2 mol dm⁻³ NaCl ($T=25\text{ }^{\circ}\text{C}$) at different current densities: (a) 100, (b) 200, (c) 300, (d) 400 and (e) 500 mA cm⁻²

U svrhu određivanja NDE, volumen izlučenog vodika formalno je preračunat u gustoću struje izlučivanja vodika, i_{H_2} , korištenjem izraza:

$$i_{\text{H}_2} = \frac{zF \left(\frac{V}{V_m} \right)}{t} \quad (1)$$

u kojem V predstavlja volumen izlučenog vodika, V_m je molarni volumen plina, z je broj elektrona koji se izmjenjuje u reakciji, t je vrijeme, a F je Faradayeva konstanta. Na Slici 4 grafički je prikazana ovisnost brzine izlučivanja vodika, izražena gustoćom struje i_{H_2} , o primijenjenoj anodnoj gustoći struje, i .

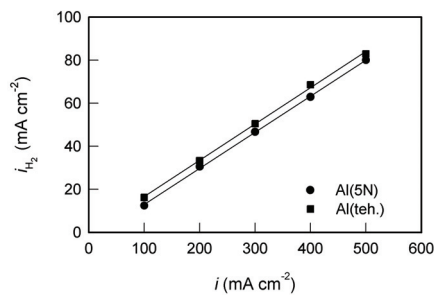

Slika 4. Ovisnost brzine izlučivanja vodika o anodnoj gustoći struje za čisti i tehnički Al u 2 mol dm⁻³ NaCl otopini pri 25 °C

Fig. 4. Dependence of hydrogen evolution rate on anodic current for pure and technical Al in 2 mol dm⁻³ NaCl solution at 25 °C

Može se vidjeti da su za oba uzorka dobivene linearne ovisnosti iz čijih je nagiba moguće odrediti NDE (Despić i sur., 1976; Dražić i sur., 1999; Weber i sur., 2003):

$$\text{NDE} = \frac{\Delta i_{\text{H}_2}}{\Delta i} \quad (2)$$

Nečistoće u tehničkom aluminiju ne utječu na iznos NDE. Naime, za oba uzorka aluminija dobivene su skoro identične vrijednosti. NDE za super čisti aluminij iznosi 0,166, a za tehnički aluminij 0,167, što je u skladu s podacima navedenim u literaturi (Despić i sur., 1976; Dražić i sur., 1999).

Kao što je rečeno, pojava NDE predstavlja jedno abnormalno ponašanje aluminija pri anodnoj polarizaciji. Objasnjenje ovog fenomena rezultiralo je pojavom više teorija o mehanizmu anodnog otapanja aluminija (Despić i sur., 1976):

- Teorija formiranja niževalentnih iona - tijekom anodnog otapanja elektrokemijskom reakcijom nastaje Al^+ ion (što predstavlja spori stupanj u ukupnom procesu otapanja) koji se dalje, budući da je nestabilan, oksidira u Al^{3+} ion. Oksidacija se odvija dijelom elektrokemijski, a dijelom kemijski. U kemijskoj reakciji sudjeluju H^+ ioni ili molekule vode, dajući vodik. Povećanjem anodne struje raste koncentracija Al^+ iona i brzina njegove daljnje kemijske oksidacije.
- Teorija razaranja oksidnog filma - izlučivanje vodika posljedica je direktne reakcije golih dijelova površine metala s elektrolitom. Anodnom polarizacijom dolazi do promjene u sastavu, poroznosti, adheziji i debljini oksidnog filma te u konačnici do njegovog razaranja. Povećanjem anodne struje razaranje filma je veće, a time i volumen izlučenog vodika.
- Teorija dezintegracije metalne površine - pri anodnom otapanju aluminija dolazi do mehaničke, djelomične dezintegracije metala. Stvaraju se vrlo sitne čestice metala koje prelaze u otopinu, gdje korodiraju uz izlučivanje vodika.

Posljednje dvije navedene teorije ne mogu protumačiti eksperimentalno ustanovljenu konstantnost NDE-a, tj. linearnu ovisnost brzine izlučivanja vodika o brzini anodnog otapanja metala. Naime, razaranje oksidnog sloja, kao i dezintegracija metalne površine su specifični procesi te na njih utječu neki faktori koji se ne mogu dovesti u vezu s mehanizmom reakcije izlučivanja vodika (Despić i sur., 1976).

Međutim, teorija nastajanja niževalentnih iona može pobliže objasniti porast NDE-a s porastom anodne gustoće struje. Spori stupanj u ukupnom procesu otapanja predstavlja elektrokemijska reakcija kojom nastaju Al^+ ioni koji se dalje, budući da su nestabilni, oksidiraju do Al^{3+} iona. Iz ove teorije proizlazi da se smanjenjem brzine sporog stupnja povećava količina intermedijernih Al^+ iona

nakupljenih na granici faza, zbog čega će porasti i njihov prijenos kroz oksidni sloj prema vodenoj otopini elektrolita. Kako se povećava anodna struja ubrzava se spori stupanj u ukupnoj reakciji otapanja metala te se na površini metala proporcionalno povećava i koncentracija intermedijernih Al^+ iona. Stoga, raste i njihov prijenos kroz oksidni sloj, a naposljetku i brzina izlučivanja vodika kao produkt reakcije Al^+ iona i vode (Despić i sur., 1976).

Neposredno prije i poslije anodne polarizacije elektrode su vagane te je određen gubitak mase, Δm , do kojeg dolazi pri anodnom otapanju Al. Gubitak mase preračunat je u struju otapanja metala preko izraza:

$$i_m = \frac{\Delta m z F}{M t} \quad (3)$$

u kojem i_m predstavlja struju koja se troši na otapanje uzorka, M je molarna masa Al, dok ostali parametri imaju uobičajeno značenje.

Na Slici 5 grafički je prikazana ovisnost brzine, tj. struje otapanja metala, i_m , o primijenjenoj anodnoj struji, i . Za oba uzorka dobivene su linearne ovisnosti, a otapanje tehničkog Al je veće od otapanja čistog Al.

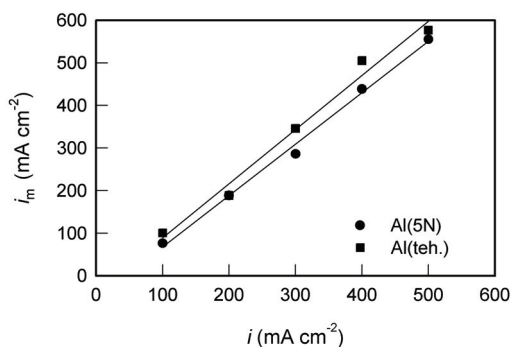

Slika 5. Ovisnost brzine otapanja metala o primijenjenoj anodnoj gustoći struje za čisti i tehnički Al u 2 mol dm^{-3} NaCl otopini pri $25 \text{ }^\circ\text{C}$

Fig. 5. Dependence of metal dissolution current on anodic current for pure and technical Al in 2 mol dm^{-3} NaCl solution at $25 \text{ }^\circ\text{C}$

Na osnovi određenih vrijednosti za brzinu izlučivanja vodika i brzinu otapanja metala, izraženih odgovarajućim gustoćama struje, moguće je procijeniti anodnu djelotvornost, η , ispitivanih uzoraka (Hori i sur., 1985).

$$\eta = \frac{i_m}{i_m + i_{H_2}} \times 100 \quad (4)$$

Povećanje struje ne utječe na anodnu djelotvornost aluminija. Kao što se može vidjeti sa Slike 6, anodna djelotvornost kod svih primijenjenih struja za oba uzorka aluminija iznosi $\approx 86\%$, što je zadovoljavajuća osobina baznog materijala za izradu anoda u kemijskim izvorima struje.

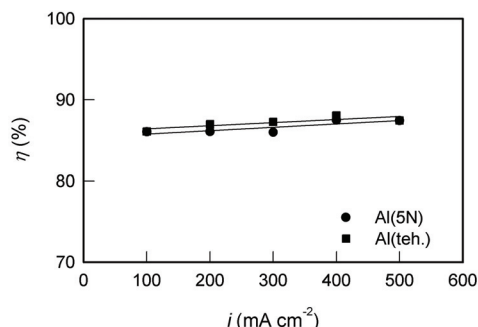

Slika 6. Ovisnost anodne djelotvornosti o primijenjenoj gustoći struje za čisti i tehnički Al u 2 mol dm^{-3} NaCl otopini pri 25°C

Fig. 6. Dependence of anode efficiency on applied current density for pure and technical Al in 2 mol dm^{-3} NaCl solution at 25°C

Nakon provedenih galvanostatičkih ispitivanja površine elektroda su mikroskopski analizirane i fotografirane, a rezultati dobiveni nakon polarizacije anodnom gustoćom struje od 200 mA cm^{-2} prikazani su na Slici 7. Slični rezultati dobiveni su i za ostale struje polarizacije.

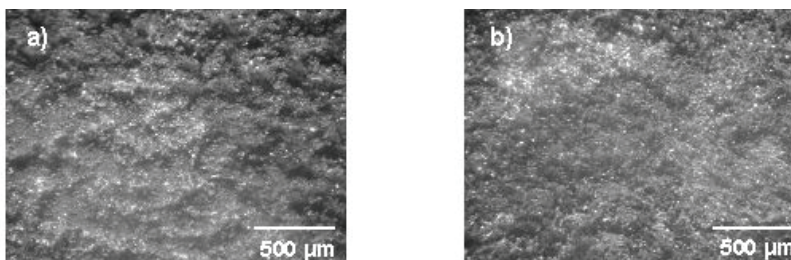

Slika 7. Snimke površina elektroda (a) čistog i (b) tehničkog aluminija nakon polarizacije anodnom gustoćom struje od 200 mA cm^{-2} u 2 mol dm^{-3} NaCl otopini pri 25°C

Fig. 7. Optical micrographs of (a) pure and (b) technical Al after polarization with anodic current density of 200 mA cm^{-2} in 2 mol dm^{-3} NaCl at 25°C

Na snimkama površine obaju uzoraka aluminija uočava se gruba morfologija, koja je ravnomjerno raširena preko cijele površine uzorka te ukazuje na pojavu

opće korozije uzoraka. Pojava opće korozije dodatna je pozitivna karakteristika anodnog materijala za Al/zrak kemijske izvore struje.

U radu je ispitan i utjecaj temperature na anodno otapanje Al u NaCl otopini. U tu svrhu elektrode su polarizirane konstantom gustoćom struje od 200 mA cm^{-2} kroz vrijeme od 15 minuta pri različitim temperaturama elektrolita (25, 35 i 45 °C). Tijekom anodne polarizacije na svakom pojedinom uzorku snimani su potencijal-vrijeme odzivi, mjereno je volumen izlučenog vodika te određen gubitak mase.

Ustanovljeno je da se porastom temperature smanjuje polarizacija (Slika 8) i anodna djelotvornost (Slika 9) obaju uzoraka aluminija.

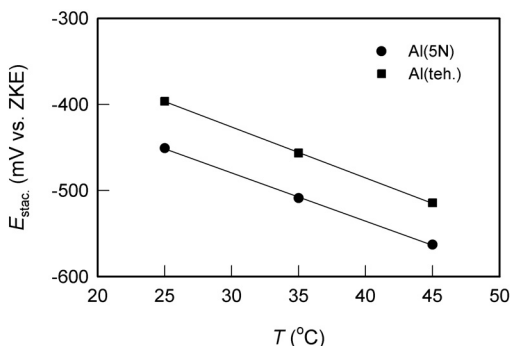

Slika 8. Ovisnost stacionarnog potencijala (pri polarizaciji uz gustoću struje od 200 mA cm^{-2}) o temperaturi NaCl otopine za čisti i tehnički Al

Fig. 8. Dependence of steady state potential (at anodic polarization of 200 mA cm^{-2}) on temperature of NaCl solution for pure and technical Al

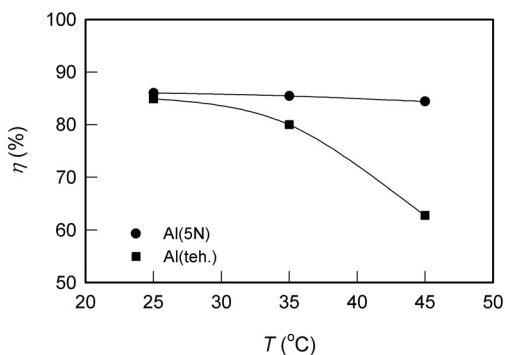

Slika 9. Ovisnost anodne djelotvornosti (pri polarizaciji uz gustoću struje od 200 mA cm^{-2}) o temperaturi NaCl otopine za čisti i tehnički Al

Fig. 9. Dependence of anode efficiency (at anodic polarization of 200 mA cm^{-2}) on temperature of NaCl solution for pure and technical Al

U promatranom području temperatura anodna djelotvornost super čistog aluminija je veća od djelotvornosti aluminija tehničke čistoće.

Zaključak

Rezultati ispitivanja anodnog ponašanja super čistog aluminija i aluminija tehničke čistoće u 2 mol dm⁻³ NaCl otopini pokazali su da:

- Kod svih primijenjenih anodnih gustoća struje dolazi do istovremenog otapanja aluminija i izlučivanja vodika. Što je anodna gustoća struje veća, veća je brzina otapanja aluminija, ali i brzina izlučivanja vodika (pojava negativnog diferencijalnog efekta).
- Aktivno otapanje čistog aluminija odvija pri nižim polarizacijama elektrode u odnosu na aluminij tehničke čistoće.
- Nečistoće u tehničkom aluminiju ne utječu na vrijednost negativnog diferencijalnog efekta. Naime, za oba uzorka aluminija dobivene su jednake vrijednosti od $\approx 0,17$.
- Anodna djelotvornost obaju uzorka aluminija iznosi ≈ 86 %, što je zadovoljavajuća osobina baznog materijala za izradu anoda u kemijskim izvorima struje.
- Porastom temperature otopine aktivno otapanje čistog i tehničkog Al se odvija kod nižih polarizacija elektrode.
- Temperatura otopine ne utječe na brzinu izlučivanja vodika na aluminiju. Međutim, povećanje temperature negativno utječe na anodnu djelotvornost oba uzorka aluminija.
- U promatranom području temperatura anodna djelotvornost super čistog aluminija je veća od djelotvornosti aluminija tehničke čistoće.

Literatura

- Despić, A.R., Dražić, D.M., Perunović, M.M., Ciković, N. (1976): Electrochemical properties of aluminium alloys containing indium, gallium and thallium, *J. Appl. Electrochem.* 6 (6), 527-542.
- Dražić, D.M., Popić, J.P. (1999): Corrosion rates and negative difference effects for Al and some Al alloys, *J. Appl. Electrochem.* 29 (1), 43-50.
- Ferrando, W.A. (2004): Development of a novel composite aluminum anode, *J. Power Sources* 130 (1-2), 309-314.
- Hori, Y., Takao, J., Shomon, H. (1985): Aluminium alloys for aluminium primary cell, *Electrochim. Acta* 30 (9), 1121-1124.
- Li, Q., Bjerrum, N.J. (2002): Aluminum as anode for energy storage and conversion: a review, *J. Power Sources* 110 (1), 1-10.
- Nestoridi, M., Pletcher, D., Wood, R.J.K., Wang, S., Jones, R.L., Stokes, K.R., Wilcock, I. (2008): The study of aluminum anodes for high power density Al/air batteries with brine electrolytes, *J. Power Sources* 178 (1), 445-455.
- Real, S., Urquidi-Macdonald, M., Macdonald, D.D. (1988): Evaluation of alloy anodes for aluminum-air batteries: II. Delineation of anodic and cathodic partial reactions, *J. Electrochem. Soc.* 135 (7), 1633-1635.

- Tuck, C.D.S., Hunter, J.A., Scamans, G.M. (1987): The electrochemical behavior of Al-Ga alloys in alkaline and neutral electrolytes, *J. Electrochem. Soc.* 134 (12), 2970-2981
- Yang, S., Knickle, H. (2002): Design and analysis of aluminum/air battery system for electric vehicles, *J. Power Sources* 112 (1), 162-173.
- Weber, C.R., Knörnschild, G., Dick, L.F.P. (2003): The negative-difference effect during the localized corrosion of magnesium and AZ91HP alloy, *J. Braz. Chem. Soc.* 14 (4), 584-593.

Anodic behaviour of aluminium in Chloride solution

I. Smoljko, S. Gudić, D. Jović

University of Split, Faculty of Chemistry and Technology, Department of Electrochemistry and Materials Protections, Teslina 10/V, 21000 Split, Croatia

Summary

The objective of research was to study the anodic behavior of super pure Al (99.999 %) and technical grade Al (99.8) in 2 mol dm⁻³ NaCl solution at 25, 35 and 45 °C. The samples were polarized anodically at different current densities (from 100 to 500 mA cm⁻²) through a 15 minute period. During the anodic polarization potential-time responses were recorded, the *volume of the evolved hydrogen was measured and* the mass loss of samples was determined. After the experiments, the surface of the tested materials was observed by using a light microscope and photographed. The dissolution of Al is accompanied by strong hydrogen evolution and the rate of these reactions has been found to increase with the increase in the anodic polarization which is a characteristic of the negative-difference effect (NDE). Furthermore, conducted studies have shown that present impurities do not affect the anodic behavior of aluminum in chloride solution. For both samples the same values of NDE (of ≈ 0.17) and anode efficiency (of ≈ 86 %) were obtained, which indicated that instead of super pure aluminum the much cheaper and more readily available technical grade aluminum can be used as anode material for aluminum/air battery systems. The temperature of solution does not affect the rate of hydrogen evolution. However, the increase of temperature has negative effect on anodic efficiency of both aluminum samples.

Keywords: aluminium, anode efficiency, negative-difference effect

Dinamička termogravimetrijska razgradnja mješavina PVC/PEO

UDC: 678.743 : 541.66

N. Stipanelov Vrandečić, M. Jakić*, I. Klarić, S. Muslim

*Sveučilište u Splitu, Kemijsko-tehnološki fakultet, Zavod za organsku tehnologiju,
Teslina 10/V, 21000 Split, Hrvatska*

Sažetak

Ubrzana toplinska razgradnja poli(vinil-klorid)/poli(etilen-oksida) mješavina u inertoj atmosferi istraživana je dinamičkom termogravimetrijom. Toplinska razgradnja "čistog" poli(vinil-klorida) i mješavina svih sastava odvija se kroz dva osnovna razgradna stupnja, dok se poli(etilen-oksida) razgrađuje kroz jedan stupanj. Toplinska stabilnost mješavina procijenjena je na osnovu različitih karakteristika termogravimetrijskih krivulja. Interakcije polimera i njihovih razgradnih produkata procijenjene su usporedbom eksperimentalnih termogravimetrijskih krivulja s onima izračunatim na osnovu pravila aditivnosti. Iz termogravimetrijskih krivulja snimljenih pri različitim brzinama zagrijavanja izračunate su aktivacijske energije toplinske razgradnje primjenom Flynn-Wall-Ozawa metode. Aktivacijska energija "čistog" poli(vinil-klorida) i mješavina ovisi o konverziji, dok je aktivacijska energija toplinske razgradnje "čistog" poli(etilen-oksida) konstantna u cijelom području istraživanih konverzija. Oblik ovisnosti aktivacijske energije o konverziji daje uvid u složenost procesa razgradnje polimernih materijala.

Ključne riječi: dinamička termogravimetrija, kinetička analiza, poli(etilen-oksida), poli(vinil-klorid)

Uvod

Polimeri se često međusobno miješaju u svrhu poboljšavanja njihovih fizikalno-mehaničkih svojstava. U novije vrijeme istražuje se primjena poli(etilen-oksida) (*PEO*) u izradi polimernih membrana za selektivno izdvajanje CO₂ iz smjese plinova (Lin, 2004). Međutim, čisti *PEO* je sklon kristalizaciji i ne može tvoriti homogene membrane bez strukturnih defekata, a također se ne može koristiti pri visokim temperaturama i tlakovima zbog loših mehaničkih svojstava pri tim uvjetima. Miješanjem *PEO*-a s relativno jeftinim poli(vinil-kloridom) (*PVC*) znatno se poboljšava čvrstoća i otpornost na trošenje ovih membrana (Luo, 2010). *PEO* u mješavini s *PVC*-om također se može upotrijebiti kao materijal za pohranu toplinske energije, ambalažni materijal, itd. (Messori et al., 2004; Ramesh et al., 2002). Budući da su ove mješavine tijekom proizvodnje i

* mjakic@ktf-split.hr

primjene izložene djelovanju topline od velike je važnosti poznavanje njihove toplinske stabilnosti.

Toplinska stabilnost svakog polimera u mješavini može biti znatno promjenjena uslijed mogućih interakcija komponenata mješavine i njihovih razgradnih produkata. Posljedica ovih interakcija može biti stabilizacija mješavine, ali također i ubrzana razgradnja. Vrsta interakcije ovisi o raspodijeli komponenata u mješavini i njihovoj mješljivosti (Ahmad et al., 2008). Istraživani su mješljivost, mehanička i morfološka svojstva mješavina *PVC/PEO* (Castro et al., 2003; da Silva Neiro et al., 2000; Luo, 2010; Margaritis, 1988), ali o toplinskoj razgradnji ovih mješavina nisu nađeni podatci u literaturi. Toplinska razgradnja mješavina *PVC/PEO* u ovom radu istraživana je dinamičkom termogravimetrijom (*TG*). Interakcije polimera i njihovih razgradnih produkata procijenjene su usporedbom eksperimentalnih *TG* krivulja s onima izračunatim na osnovu pravila aditivnosti. Pomoću Flynn-Wall-Ozawa izokonverzijske metode nastojalo se izračunati aktivacijsku energiju razgradnog procesa i na osnovu tih podataka dobiti uvid u kinetičku shemu odvijanja toplinske razgradnje mješavina *PVC/PEO*.

Kinetička analiza

Toplinska razgradnja čvrstog polimernog materijala složeni je proces koji se sastoji od N paralelnih i /ili sljedbenih reakcija, od kojih svaka vodi nastajanju čvrstog i plinovitog produkta (Budruga, 2000).

Za i -tu reakciju konverzija je opisana relacijom:

$$\alpha_i = \frac{\Delta m_i}{\Delta m_i^\infty} \quad (1)$$

gdje je Δm_i gubitak mase u reakciji i u vremenu t , a Δm_i^∞ ukupni gubitak mase u reakciji i .

Ukupna konverzija je:

$$\alpha = \frac{\sum_i \Delta m_i}{\sum_i \Delta m_i^\infty} \quad (2)$$

Uz pretpostavku da je konstanta brzine reakcije opisana Arrheniusovom jednađbom brzina razgradnog procesa jednaka je:

$$\frac{d\alpha_i}{dt} = f_i \left(\alpha_1, \alpha_2, \dots, \alpha_i, \dots, \alpha_N, \frac{1}{T} \right)_{i=1,2,\dots,N} \quad (3)$$

Budući da je toplinska razgradnja polimernog materijala složeni proces s nedovoljno poznatim mehanizmom, umjesto sustava diferencijalnih jednađbi, koristi se sljedeći izraz za ukupnu brzinu razgradnog procesa:

$$\frac{d\alpha}{dt} = f(\alpha) A \exp \left(-\frac{E}{RT} \right) \quad (4)$$

u kojem su E i A prividni kinetički parametri, a $f(\alpha)$ je prividna razgradna funkcija, odnosno kinetički model koji opisuje mehanizam reakcije. Integriranjem jednađba (4) postaje:

$$g(\alpha) = kt \quad (5)$$

gdje je $g(\alpha) = \int_0^{\alpha} \frac{d\alpha}{f(\alpha)}$

Za neizotermne radne uvjete može se eliminirati eksplicitna vremenska ovisnost kinetičke jednađbe uvođenjem brzine zagrijavanja. U slučaju konstantne brzine zagrijavanja $\beta = dT/dt$:

$$\frac{d\alpha}{dt} = \frac{1}{\beta} \frac{d\alpha}{dT} \quad (6)$$

pa jednađba (5) postaje:

$$g(\alpha) = \frac{A}{\beta} \int_0^T \exp \left(-\frac{E}{RT} \right) dT \quad (7)$$

Za pouzdanu kinetičku analizu neizotermnih podataka potreban je niz TG krivulja snimljenih pri različitim brzinama zagrijavanja. Pomoću njih može se izračunati aktivacijska energija različitim izokonverzijskim metodama bez poznavanje oblika funkcije $f(\alpha)$, tzv. "model-free" metoda. Ove metode također omogućavaju određivanje ovisnosti E o stupnju razgradnje. Vyazovkin i suradnici (1997) dokazali su da mnoge reakcije u čvrstom stanju nisu jednostavni jednostupanjski procesi i da kombinacija sljedbenih i paralelnih

elementarnih reakcija mora rezultirati aktivacijskom energijom koja se mijenja tijekom odvijanja procesa.

Integralna izokonverzijska metoda temelji se na jednadžba (7) koja se često piše u obliku:

$$g(\alpha) = \frac{AE}{\beta R} p(x) \quad (8)$$

Temperaturni integral u jed. (7) zamijenjen je aproksimacijom $p(x)$ u svrhu dobivanja linearne jednadžbe potrebne za izračunavanje aktivacijske energije, $x = E/RT$.

Flynn-Wall-Ozawa (FWO) metoda (Tanaka, 1995) za rješenje temperaturnog integrala uzima Doylovu aproksimaciju $p(x) = -5,33 - 1,05 x$, i koristi jednadžbu:

$$\ln \beta = \ln \frac{AE}{R g(\alpha)} - 5,33 - 1,05 \frac{E}{R T} \quad (9)$$

koja se za određenu konverziju linearizira u koordinatnom sustavu $\ln \beta$ nasuprot $1/T$. Iz nagiba pravca izračuna se aktivacijska energija.

Izokonverzijske metode omogućavaju izračunavanje prividne aktivacijske energije procesa bez poznavanja oblika funkcije $f(\alpha)$, odnosno mehanizma reakcije. Također se mogu upotrijebiti za izračunavanje ovisnosti aktivacijske energije o stupnju konverzije. Smatra se da za složeni proces, poput toplinske razgradnje polimernog materijala, upravo treba očekivati ovisnost E o α (Budrugač, 2000). Nedostatak ovih metoda je taj što ne omogućavaju direktno izračunavanje predeksponencijalnog faktora ili kinetičkog modela, već se ove veličine moraju odrediti drugim metodama.

Materijal

Za pripremu mješavina upotrijebljeni su komercijalni polimerni prahovi PVC-a ($M_v = 86000$), proizvođača Solvin, Belgija i PEO-a ($M_v = 300000$), proizvođača Dow Chemical, SAD.

PVC/PEO mješavine različitih masenih omjera (100/0, 80/20, 60/40, 50/50, 40/60, 20/80 i 0/100) pripremljene su miješanjem polimernih prahova u laboratorijskom ekstruderu (Dynisco, Qualitest North America) pri 160 °C i brzini pužnog vijka od 180 okr/min. Nakon ekstrudiranja uzorci su toplo presani. Da bi se spriječila toplinska razgradnja PVC-a tijekom ekstrudiranja u mješavine je dodano 2 mas. % Ca/Zn stabilizatora (Reapack B-NT/7060).

Toplinska razgradnja istraživanih polimera provedena je dinamičkom termogravimetrijom pomoću Perkin Elmer Pyris 1 TGA uređaja. TG krivulje PVC/PEO mješavina snimljene su u struji dušika (30 cm³/min) u temperaturnom

području 50 - 650 °C brzinama zagrijavanja 2,5; 5; 10 i 20 °C/min. Određene su karakteristike termogravimetrijskih (*TG*) i diferencijalnih termogravimetrijskih (*DTG*) krivulja: temperatura početka razgradnje (T_{onset}), temperatura pri kojoj polimer izgubi 5 % početne mase ($T_{5\%}$), temperatura pri maksimalnoj brzini razgradnje (T_{max}), maksimalna brzina razgradnje (R_{max}), gubitak mase nakon prvog i drugog razgradnog stupnja (Δm_1 i Δm_2) i ostatna masa (m_f).

Rezultati i rasprava

Rezultat razgradnje su *TG* krivulje koje predstavljaju gubitak mase u ovisnosti o temperaturi, odnosno *DTG* krivulje koje predstavljaju brzinu promjene mase uzorka u ovisnosti o temperaturi. Na Slici 1 prikazane su *TG* i *DTG* krivulje *PVC*-a i *PEO*-a snimljene pri četiri različite brzine zagrijavanja, a na Slici 2 *TG* i *DTG* krivulje mješavina svih sastava pri brzini 2,5 °C/min.

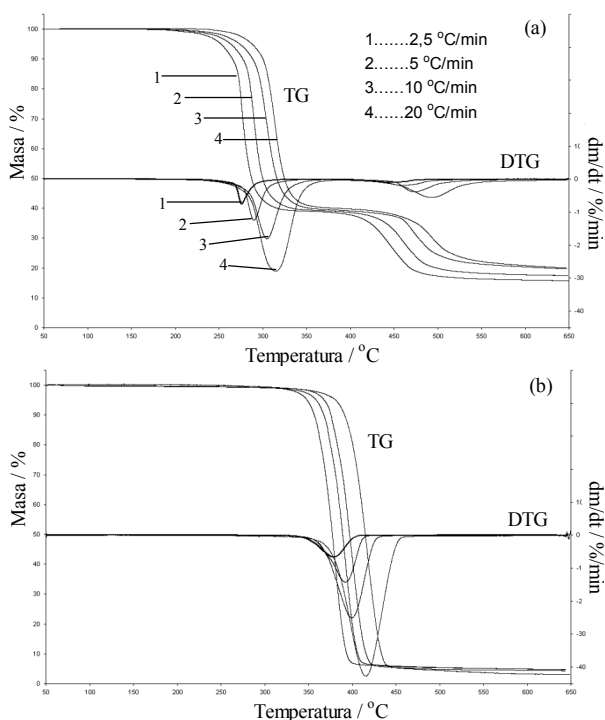

Slika 1. Dinamičke *TG* i *DTG* krivulje snimljene pri različitim brzinama zagrijavanja: (a) *PVC* i (b) *PEO*

Fig. 1. Dynamic *TG* and *DTG* curves of thermal degradation recorded at different heating rates: (a) *PVC* and (b) *PEO*

Razgradnja "čistog" *PVC*-a odvija se u temperaturnom području od 220 - 600 °C kroz dva temeljna razgradna stupnja što se očituje pojavom dvaju pikova na *DTG* krivulji (Slika 1a). U prvom razgradnom stupnju do 400 °C autokatalitičko dehidrokloriranje *PVC*-a je osnovni razgradni proces praćen sporednim procesima umrežavanja, ciklizacije poliena i nastajanja benzena (Stipanelov Vrandečić, 2004). Toplinska razgradnja "čistog" *PEO*-a odvija se u jednom razgradnom stupnju, jedan pik na *DTG* krivulji, u temperaturnom području od 320 - 450 °C (Slika 1b) statističkim cijepanjem lanca pri čemu nastaju niskomolekulni spojevi, uglavnom α -peroksidi i esteri mravlje kiseline (Pielichowski, 2005). Toplinska razgradnja mješavina *PVC/PEO* također se odvija kroz dva osnovna razgradna stupnja. (Slika 2).

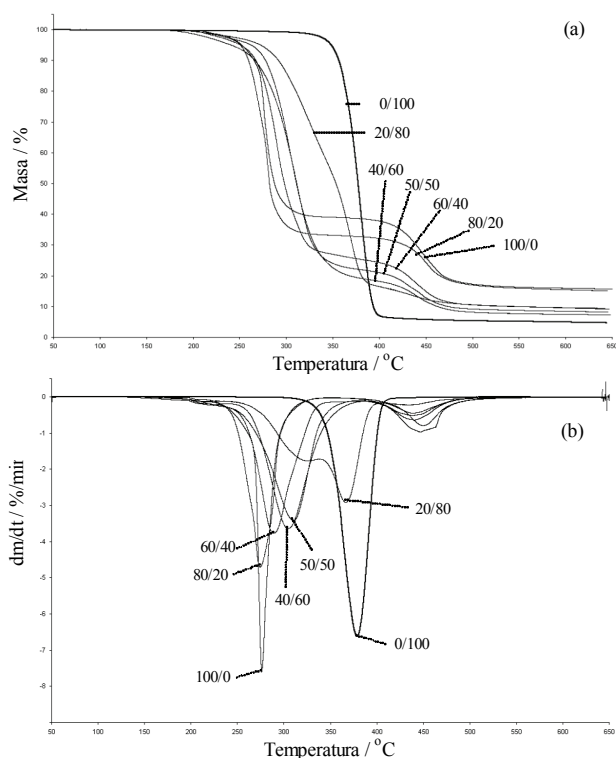

Slika 2. (a) *TG* i (b) *DTG* krivulje mješavina *PVC/PEO* različitog sastava;
brzina zagrijavanja 2,5 °C/min
Fig. 2. (a) *TG* and (b) *DTG* curves for *PVC/PEO* blends of different composition;
heating rate 2.5 °C/min

Na *DTG* krivulji mješavine sastava 20/80 uočavaju se dva maksimuma u prvom razgradnom stupnju. Prvi se odnosi na dehidrokloriranje *PVC*-a, a drugi na razgradnju *PEO*-a. Kod ostalih mješavina ovi su se pikovi "stopili" u jedan.

Povećanjem brzine zagrijavanja *TG* krivulje svih istraživanih mješavina pomiču se u desno k višim temperaturama.

Da bi se utvrdio utjecaj *PEO*-a na toplinsku stabilnost *PVC*-a, iz *TG* i *DTG* krivulja snimljenih pri brzini zagrijavanja 2,5 °C/min određene su značajke razgradnog procesa i prikazane su u tablici 1. T_{onset} i $T_{5\%}$, "čistog" *PVC*-a iznosi 270, odnosno 256 °C. Povećanjem udjela *PEO*-a u mješavini do 60 % ove se temperature gotovo ne mijenjaju, a dodatkom 80 % *PEO*-a porastu za oko 15 °C. Odgovarajuće temperaturne karakteristike za "čisti" *PEO* približno su 90 °C više nego za *PVC*. T_{max} raste promjenom sastava mješavine od 276 °C (za *PVC*) do 375 °C (za *PEO*). Brzine razgradnje pri T_{max} za oba polimera su približno jednakih vrijednosti. Dodatkom jednog ili drugog polimera ova brzina se smanjuje i za mješavine sastava 60/40 - 20/80 ima približno iste vrijednosti. Konverzija pri maksimalnoj brzini razgradnje iznosi 34 % za *PVC* i 59 % za *PEO*, dok je konverzija mješavine između ovih vrijednosti. *PVC* u prvom razgradnom stupnju izgubi 60 % mase. Ovaj gubitak mase, koji je nešto veći od stehiometrijske količine klora sadržane u *PVC*-u (cca 56 %), odgovara potpunom dehidrokloriranju polimera. Drugi razgradni stupanj s prosječnim gubitkom mase 23 % predstavlja razgradnju polienskih sekvencija nastalih u prvom razgradnom stupnju. Na kraju drugog razgradnog stupnja zaostaje prosječno 16 % mase koja se ne mijenja daljnjim porastom temperature do 650 °C. Masa koju pojedina mješavina *PVC/PEO* izgubi na kraju prvog razgradnog stupnja, Δm_1 , ovisi o njenom sastavu i linearno se povećava povećanjem udjela *PEO*-a u mješavini dok se Δm_2 linearno smanjuje. Masa uzorka koja zaostane na kraju razgradnje najveća je za *PVC* 15 %, dodatkom *PEO*-a smanjuje se linearno do 5 % koliko iznosi za *PEO*.

Eksperimentalne *TG* krivulje uspoređene su s krivuljama izračunatim na osnovu pravila aditivnosti. Na Slici 3 prikazan je primjer za mješavinu sastava 80/20.

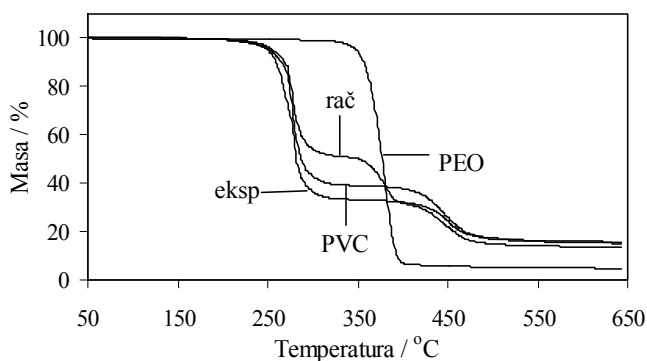

Slika 3. Usporedba eksperimentalnih i izračunatih *TG* krivulja za mješavinu sastava 80/20
Fig. 3. Comparison of the experimental and calculated *TG* curves for 80/20 blend

Eksperimentalne *TG* krivulje uglavnom slijede izračunate vrijednosti do temperaturnog intervala približno 200 - 215 °C za sve mješavine osim mješavine 50/50 za koju je ova temperatura 176 °C. Pri višim temperaturama postižu se konverzije razgradnje veće od očekivanih, pa se može zaključiti da postoje interakcije istraživanih polimera i njihovih razgradnih produkata. Veličina interakcija može se izraziti kao razlika eksperimentalnog i izračunatog stupnja konverzije, $\Delta\alpha$, ($\Delta\alpha = (\alpha_{\text{exp}} - \alpha_{\text{rač}})/\alpha_{\text{rač}}$) i prikazana je na Slici 4 za sve mješavine.

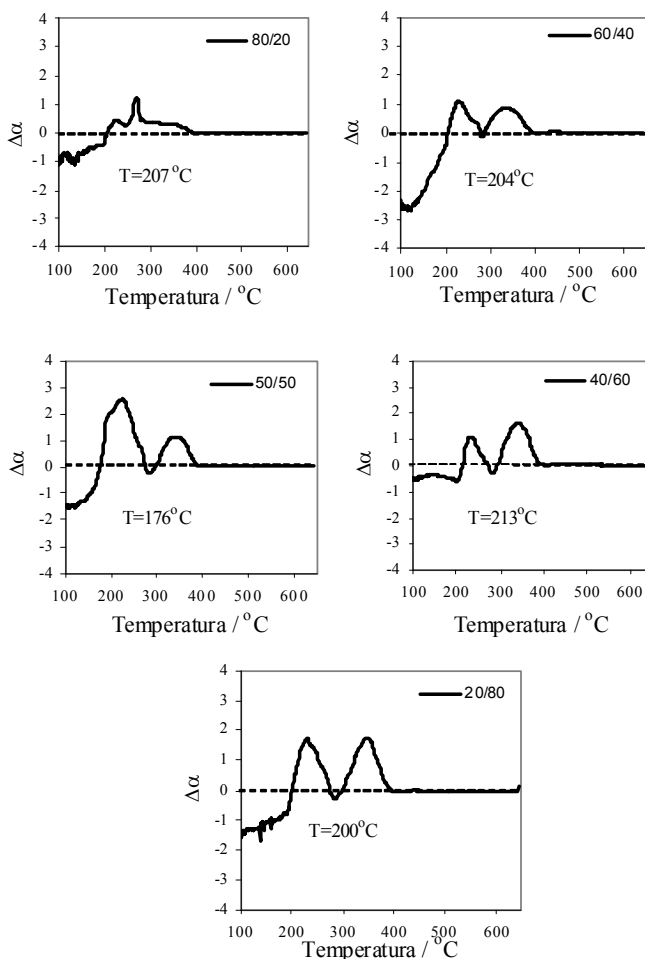

Slika 4. Ovisnost $\Delta\alpha$ o razgradnoj temperaturi za mješavine *PVC/PEO*; brzina zagrijavanja 2,5 °C/min. Istaknute temperature označavaju temperature do kojih *PEO* toplinski stabilizira *PVC* ($\Delta\alpha < 0$)

Fig 4. Dependence of $\Delta\alpha$ on the degradation temperature for *PVC/PEO* blends; heating rate 2.5 °C/min. Propound temperatures refers to the temperatures till the *PEO* thermally stabilize the *PVC* ($\Delta\alpha < 0$)

Vrijednost $\Delta\alpha < 0$ ukazuje na bolju toplinsku stabilnost od očekivane. Za mješavine *PVC/PEO* vrijednost $\Delta\alpha$ je negativna pri relativno niskim temperaturama od 200 do 213 °C. Toplinska stabilnost mješavine sastava 50/50 veća je od teorijske do 176 °C.

Aktivacijska energija (E) procesa toplinske razgradnje određena je primjenom izokonverzijske *FWO* metode. Toplinska razgradnja čistih komponenti *PVC*-a i *PEO*-a kao i njihovih mješavina je složen proces tijekom kojeg se odvija niz kemijskih reakcija i fizikalnih procesa s nekom ukupnom brzinom koja je funkcija brzine kemijskih reakcija i brzine fizikalnih procesa (difuzije), a određena je najsporijim stupnjem. Stoga je energija izračunata izokonverzijskom metodom prividna E , koja nije nužno potrebna za aktiviranje reaktanata i može biti sasvim različita od prave koja predstavlja minimalnu količinu energije koju treba dovesti molekulama da bi mogle reagirati (Martinez, 1993). Ovo proizlazi iz prirode *TG* koja mjeri gubitak mase uzorka zbog njegovog rasplinjavanja pri određenom temperaturnom programu. Osim toga, *TG* nije kemijski specifična jer ne može mjeriti brzinu elementarnog stupnja, već samo ukupnu brzinu procesa. Da bi se kinetički potpuno opisao proces toplinske razgradnje *PVC*-a, *PEO*-a i njihovih mješavina, bilo bi potrebno izračunati i kinetički model, $f(\alpha)$ te predeksponencijalni faktor, A . Budući da toplinske metode analize ne daju podatke o mehanizmu toplinske razgradnje polimera već samo o brzini razgradnje, određivanjem ovisnosti aktivacijske energije mogu se dobiti informacije o kinetičkoj shemi odvijanja razgradnog procesa. Grafičko određivanje E za sve uzorke prema *FWO* metodi provedeno je primjenom jed. (9) koristeći α - T vrijednosti očitane iz *TG* krivulja snimljenih pri četiri različite brzine zagrijavanja. Na Slici 5 prikazani su odabrani izokonverzijski pravci za mješavine sastava 100/0 i 50/50, a na Slici 6 ovisnost E o konverziji za sve analizirane uzorke u cijelom području konverzija

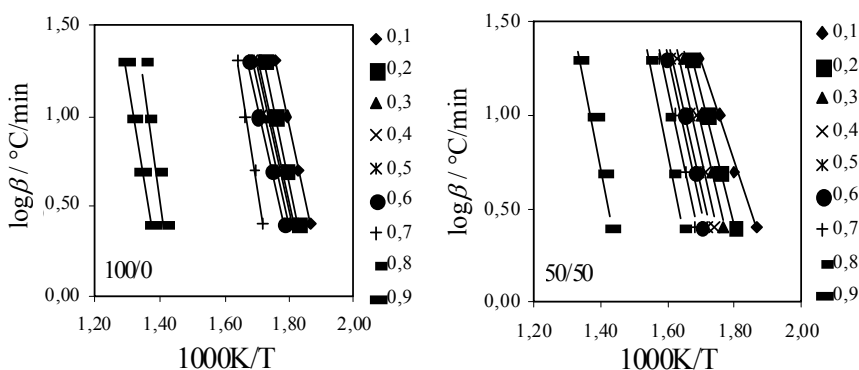

Slika 5. Izokonverzijski pravci za mješavine *PVC/PEO* sastava 100/0 i 50/50

Fig. 5. The isoconversional straight lines for *PVC/PEO* blends of composition 100/0 and 50/50

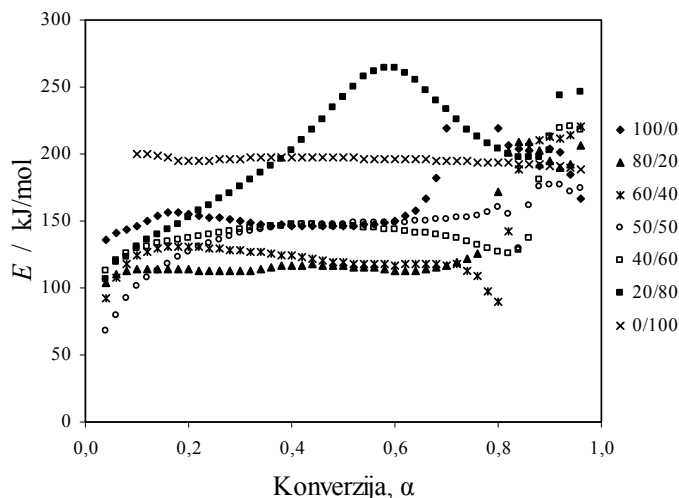

Slika 6. Ovisnost E o konverziji za mješavine *PVC/PEO*
Fig. 6. Dependence of E on conversion for *PVC/PEO* blends

Iz oblika ovisnosti aktivacijske energije o konverziji vidljivo je da se toplinska razgradnja *PVC*-a i *PEO*-a odvija različitim kinetičkim shemama. Aktivacijska energija razgradnje *PVC*-a i mješavina svih sastava ovisi o konverziji i do konverzije 70 %, što odgovara prvom razgradnom stupnju, iznosi 100 - 250 kJ/mol. Aktivacijska energija drugog razgradnog stupnja znatno je viša, a oblik krivulje ukazuje na kompleksnost razgradnog procesa. Aktivacijska energija toplinske razgradnje *PEO*-a konstantna je u cijelom području konverzija i iznosi 160 kJ/mol.

Zaključak

Dinamička toplinska razgradnja *PVC*-a i mješavina *PVC/PEO* u inertu odvija se u temperaturnom području 50 - 650 °C kroz dva temeljna razgradna stupnja, dok se *PEO* razgrađuje kroz jedan razgradni stupanj.

Termogravimetrijska analiza pokazala je da postoje interakcije istraživanih polimera i njihovih razgradnih produkata. Dodatak jednog ili drugog polimera mješavini smanjuje maksimalnu brzinu razgradnje druge komponente u svim mješavinama. Usporedbom eksperimentalnih *TG* podataka i podataka izračunatih na osnovu pravila aditivnosti nađeno je da *PEO* toplinski stabilizira *PVC* u ranim fazama razgradnje (od 176 do 213 °C) ovisno o sastavu mješavine. Oblik ovisnosti aktivacijske energije o konverziji ukazuje na različite mehanizme razgradnje *PVC*-a i *PEO*-a i na kompleksnost procesa razgradnje njihovih mješavina.

Literatura

- Ahmad Z., Al-Awadi N.A., Al-Sagheer F. (2008): Thermal degradation studies in poly(vinyl chloride)/poly(methyl methacrylate) blends, *Polym. Degrad. Stab.* 93, 456-465.
- Budrugaec P. (2000): On the evaluation of the thermal lifetime of polymeric materials which exhibit a complex mechanism of thermal degradation consisting of two successive reactions, *Polym. Degrad. Stab.* 67, 271-278.
- Castro R.E.N., Toledo E. A., Rubira A. F., Muniz E. C. (2003): Crystallisation and miscibility of poly(ethylene oxide)/poly(vinyl chloride) blends, *J. Mat.Sci.* 38, 699-703.
- Da Silva Neiro S.M., Dragunski D. C., Rubira A. F., Muniz E. C. (2000): Miscibility of PVC/PEO blends by viscosimetric, microscopic and thermal analyses, *Europ. Polym. J.* 36, 583-589.
- Lin H., Freeman B.D. (2004): Gas solubility, diffusivity and permeability in poly(ethylene oxide), *Journal of Membrane Science* 239, 105-117.
- Luo Z., Jiang J. (2010): Molecular dynamics and dissipative particle dynamics simulations for the miscibility of poly(ethylene oxide)/poly(vinyl chloride) blends, *Polymer* 51, 291-299.
- Margaritis A.G., Kalfoglou N.K. (1988): Compatibility of Poly(vinyl chloride) with Polyalkyleneoxides. I. Poly(methylene oxide) and Poly(ethylene oxide), *J.Polym.Sci.: Part B: Polym. Phys.* 26, 1595-1612.
- Martinez G., Gomez-Elvira J. M., Milan J. (1993): Influence of tacticity on the thermal degradation of PVC. Part 7—Further approaches to the conformational mechanism through a temperature effect study, *Polymer Degradation and Stability*, 40, 1, 1-8.
- Messori M., Toselli M., Pilati F., Fabbri E., Fabbri P., Pasquali L., Nannarone S., (2004): Prevention of plasticizer leaching from PVC medical devices by using organic-inorganic hybrid coatings, *Polymer* 45, 805-813.
- Pielichowski K., Flejtuch K. (2005): Non-oxidative thermal degradation of poly(ethylene oxide): kinetic and thermoanalytical study, *J. Anal. Appl. Pyrolysis* 73, 131-138.
- Ramesh S., Yahaya A.H., Arof A.K. (2002): Miscibility studies of PVC blends (PVC/PMMA and PVC/PEO) based polymer electrolytes, *Solid State Ionics* 148, 483-486.
- Stipanelov Vrandečić N., Klarić I., Kovačić T. (2004): Thermooxidative degradation of poly(vinyl chloride)/chlorinated polyethylene blends investigated by thermal analysis methods, *Polym. Degrad. Stab.* 84, 23-30.
- Tanaka H. (1995): Thermal analysis and kinetics of solid state reactions, *Thermochim. Acta* 267, 29-44.
- Vyazovkin S., Wight C.A. (1997): Kinetics in Solids, *Annu. Rev. Phys. Chem.* 48, 125-149.

Dynamic thermogravimetric degradation of PVC/PEO blends

N. Stipanelov Vrandečić, M. Jakić, I. Klarić, S. Muslim

University of Split, Faculty of Chemistry and Technology, Teslina 10/V, 21000 Split, Croatia

Summary

Poly(ethylene oxide) in the blend with poly(vinyl chloride) can be used as thermal energy storage material, packaging material and as membrane material for CO₂ capture because of the strong affinity of poly(ethylene oxide) segments for CO₂. Since these blends are in contact with heat during their processing and their application as well, a good knowledge of their thermal stability is important. To investigate the behaviour of poly(vinyl chloride)/poly(ethylene oxide) blends in the inert atmosphere, accelerated thermal degradation of this blends was investigated by means of dynamic thermogravimetric analysis. The thermal degradation of pure poly(vinyl chloride) and poly(vinyl chloride)/poly(ethylene oxide) blends occurs through two basic degradation steps, while thermal degradation of poly(ethylene oxide) occurs through one degradation step. To estimate the thermal stability of the blends, the different characteristics of thermogravimetric curves for the first basic degradation steps were used. The interactions of blend components and its degradation products were evaluated by comparison of the experimental thermogravimetric curves with those calculated according to the additivity rule. From the thermogravimetric curves recorded at the different heating rates the activation energies were calculated by isoconversional Flynn-Wall-Ozawa method. The activation energies of thermal degradation of pure poly(vinyl chloride) and poly(vinyl chloride)/poly(ethylene oxide) blends depend on the degree of conversion, while the activation energies of poly(ethylene oxide) thermal degradation are independent. Dependence of the activation energies on the degree of conversion provides information about complexity of polymeric material degradation.

Keywords: dynamic thermogravimetric analysis, kinetic analysis, poly(ethylene oxide), poly(vinyl chloride)

Investigation of corrosion behavior of AISI 316L steel in NaCl solution

UDC: 669.15-194 : 620.178.1

L. Vrsalović*, M. Kliškić, M. Tanfara

University of Split, Faculty of Chemistry and Technology, Department of Electrochemistry and Protection of Materials, Teslina 10/V, 21000 Split, Croatia

Summary

The corrosion behavior of AISI 316L stainless steel in 0.5 mol dm⁻³ NaCl solution was investigated in a quiescent solution, with an electrode rotation rate of 400 rpm, and at electrolyte temperatures 20, 40 and 60 °C. The investigation included open circuit potential measurements, linear polarization measurements and potentiodynamic polarization measurements. The corroded electrode surface was investigated under an optical microscope after the potentiodynamic polarization measurements. The investigation results have shown that an increase in electrolyte temperature leads to an increase in the corrosion current densities and to a decrease the values of polarization resistance, which meant higher corrosion of steel. The electrode rotation also increases the values of corrosion current density and decreases the values of polarization resistance. The microscopic investigations have shown that the dominant corrosion attack is pitting corrosion. The increase in electrolyte temperature leads to the increase the number of corrosion pits on the electrode surface.

Keywords: stainless steel, corrosion, potentiodynamic polarization

Introduction

Austenitic stainless steels find a wide range of applications as construction materials due to their favorable mechanical properties, good corrosion resistance and acceptable price (Kožuh et al., 2008; Kulušić et al., 2004). High corrosion resistance of austenitic stainless steels is primarily attributed to the passive oxide film formed on its surface that, exposed to an aqueous solution, is a mixture of iron and chromium oxides, with hydroxide and water-containing compounds located in the outermost region of the film and chromium oxide enrichment at the metal-film interface (Marcus, 1988). However, the resistance of this passive film is determined by the environmental conditions the stainless steel is exposed to and by the alloy composition as well (Pardo et al., 2008).

Under the action of aggressive ions, like chloride anions, a local breakdown of passivity occurs, mainly at sites of local heterogeneities, causing the pitting corrosion. The initiation of pitting is the result of the breakdown of the passive

*ladislav@ktf-split.hr

film on the metal due to the presence of certain anions such as Cl^- and the subsequent establishment of an electrochemical cell in which the damaged site acts as an anode and the passive site acts as a cathode.

One of the important environmental parameters that have a strong impact on pitting corrosion is the temperature of the electrolyte. Increasing the temperature usually is also increasing the pitting tendency of metals and alloys. At low temperature, high pitting potentials are observed whereas at higher temperature frequently lower values are measured (Matsch, 2000).

In practice applications, the products made of steel are often exposed to different fluid flows and sometimes the metal itself moves within a fluid (e.g. propellers, turbines, etc.). In these conditions the corrosion process may be significantly different compared to the corrosion process in still conditions. The motion can increase the rate of general corrosion and also initiate or prevent local corrosion attack, depending on the type and intensity of corrosion of fluid motion (Schmit, 1995). It is therefore important to examine the corrosion behavior of steel in terms of fluid or metal motion and compare it with the corrosion behavior of steel in a quiescent solution.

This paper deals with the influence of the temperature of electrolyte and the electrode rotation on pitting corrosion of AISI 316L stainless steel in 0.5 mol dm^{-3} NaCl solution.

Materials and Methods

A disc-working electrode suitable for a Radiometer Analytical EDI 101 rotating disc system was machined from cylindrical rod of diameter 8 mm. The chemical composition of the AISI 316L stainless steel is given in Table 1.

The exposed electrode surface was abraded with different grades of emery papers, and finally polished up to a mirror finish, degreased in ethanol, rinsed with double distilled water and immersed in the electrolyte. Electrochemical experiments were carried out in a conventional three-electrode electrochemical cell, with a platinum counter electrode and a saturated calomel electrode (SCE), placed in Luggin capillary, as a reference electrode. All potentials are referred to a SCE electrode. Investigated solutions were prepared from p.a. reagents. The electrolyte solution was 0.5 mol dm^{-3} NaCl solution. The experiments were performed in a quiescent solution and at the electrode rotation rate of 400 rpm, in the temperature range from 20 °C to 60 °C.

Table 1. Chemical composition of AISI 316L stainless steel

Element	Composition/(wt. %)
C	0.018
Mn	1.50
P	0.036
S	0.002
Si	0.33
Cu	0.39
V	0.078
Mo	1.91
Al	0.006
Cr	17.34
Ni	10.56
Sn	0.013
W	0.121
Ti	0.003
Co	0.19
Pb	0.019
Nb	0.025
Mg	0.020
Zn	0.044
Fe	67.40

Open circuit potential measurements of AISI 316L in 0.5 mol dm⁻³ NaCl solution were performed in the time period of 180 minutes.

Potentiodynamic polarization measurements were performed with a scanning rate of 0.2 mV s⁻¹, in the potential range from -0.8 to 0.9 V toward corrosion potential (E_{corr}). Linear polarization measurements were performed in the vicinity of E_{corr} in the potential range ± 20 mV, at a scanning rate of 0.2 mV s⁻¹.

All electrochemical measurements were performed with PAR M273A potentiostat/galvanostat.

After the polarization measurements the electrode surface was examined by optical microscope Citoval, Carl Zeiss Jena, with magnifications of 25 and 100 times.

Results and Discussion

The open circuit potential (E_{OC}) against time plots for the AISI 316L in the quiescent 0.5 mol dm⁻³ NaCl solution and with electrode rotation rate of 400 rpm, at 20 °C is shown in Fig. 1:

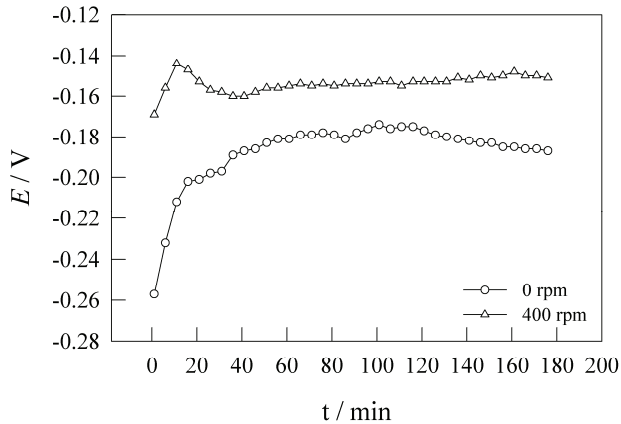

Fig. 1. Variation of open circuit potential with time of the AISI 316L in 0.5 mol dm⁻³ NaCl solution at 20 °C

From the Fig. 1 it can be seen that instantly after the immersion of electrode in the electrolyte solution, the value of open circuit potential moves to the positive potential direction, probably due to formation of protective oxide film on the steel surface. The stable value of E_{OC} was established in the period of 60 min. Electrode rotation leads to stabilization of E_{OC} on slightly positive value compared to stabilization of potential in the quiescent solution.

Fig. 2 shows the potentiodynamic polarization curves for EISI 316L in 0.5 mol dm⁻³ NaCl solution at 20 °C for the measurements with the stationary electrode and with the electrode rotation rate of 400 rpm.

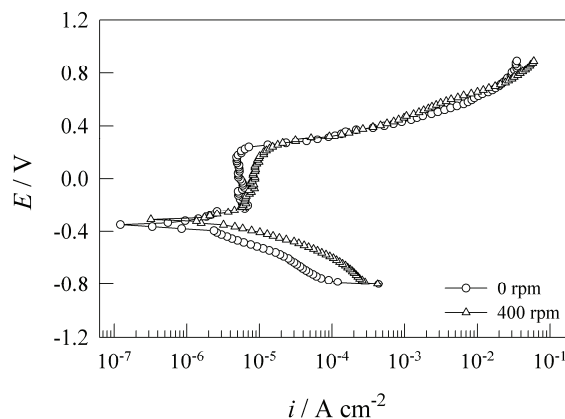

Fig. 2. Potentiodynamic polarization curves of the AISI 316L in 0.5 mol dm⁻³ NaCl solution at 20 °C

The influence of electrolyte temperature on polarization curves is shown on Fig. 3.

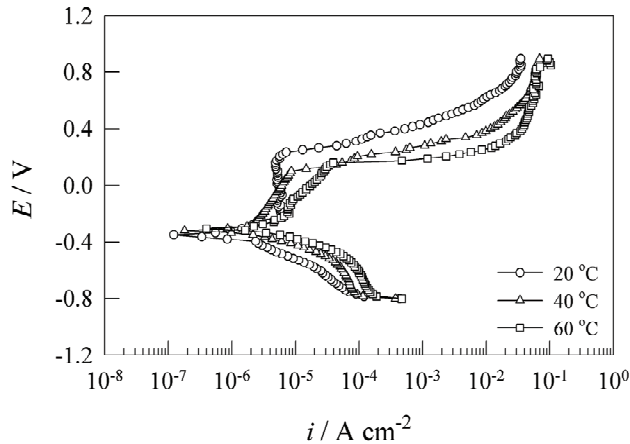

Fig. 3. Potentiodynamic polarization curves of the AISI 316L in quiescent 0.5 mol dm^{-3} NaCl solution at different temperatures of electrolyte

From the presented potentiodynamic polarization curves it can be seen that the electrode rotation increased the cathodic current density which means the electrode rotation influence on cathodic reaction oxygen reduction. Immediately after corrosion potential there is an initial increase in anodic current density at low potential changes. When the current density reaches the value of approximately $5 \times 10^{-6}\text{ A cm}^{-2}$, a further potential change does not lead to an increase in current density up to achieving the critical potential value. For the investigation at $20\text{ }^\circ\text{C}$ the breakdown of the passive film on steel surface occurs at the potential of approximately 0.3 V , and after that potential, the current density rises sharply due to intensive corrosion attack on the steel surface.

From the Fig. 3 it can be seen that changes in the electrolyte temperature leads to some changes in anodic and cathodic parts of polarization curves. A higher electrolyte temperature leads to an increase in the anodic and cathodic current densities. Increasing temperature of electrolyte leads to lowering the values of pitting potentials, which is also observed in the literature (Malik et al., 1992; Matsch, 2000).

The results of potentiodynamic polarization studies are collected in Table 2, which comprises corrosion potential (E_{corr}), corrosion current densities (i_{corr}) and cathodic Tafel slope values (b_c).

Table 2. Corrosion parameters for the AISI 316L steel in a 0.5 mol dm⁻³ NaCl solution

T/°C	ω/min^{-1}	E_{corr}/V	$i_{\text{corr}}/\mu\text{A cm}^{-2}$	$b_c/\text{V dec}^{-1}$
20	0	-0.365	1.35	-0.1876
20	400	-0.320	2.42	-0.1580
40	0	-0.323	2.21	-0.1576
40	400	-0.300	3.75	-0.1592
60	0	-0.312	3.51	-0.1502
60	400	-0.344	5.34	-0.1451

It is evident that an increase in electrolyte temperature leads to an increase in corrosion current density values, which means that more intense corrosion of steel occurs. The electrode rotation also leads to increase in corrosion current densities, which shows that electrode rotation has adverse effect on corrosion resistance of the investigated stainless steel.

The polarization resistance measurements were performed by applying a controlled potential scan over a small potential range, ± 20 mV with respect to E_{corr} . The resulting current is linearly plotted versus potential and the slope of this plot at E_{corr} being the polarization resistance, R_p .

Fig. 4 shows the linear parts of the polarization curves obtained by the linear polarization measurements for AISI 316L steel in 0.5 mol dm⁻³ NaCl solution, at 20 °C, with stationary electrode and with electrode rotation rate of 400 rpm.

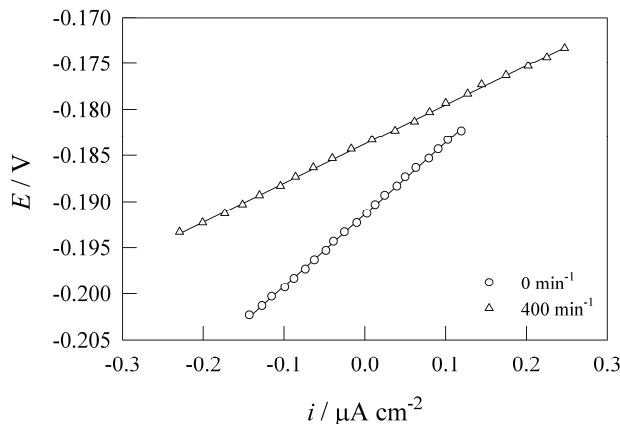

Fig. 4. Linear parts of polarization curves for polarization resistance determination of the AISI 316L in 0.5 mol dm⁻³ NaCl solution at 20 °C

The slope of the linear part of the curve is lower for the measurement with electrode rotation, which means that the polarization resistance is lower. Table 3 shows the values of polarization resistance for the AISI 316L stainless steel in NaCl solution at different temperatures.

The data from Table 3 show that an increase in electrolyte temperature leads to a decrease in the values of polarization resistance. The values of polarization resistance are lower for the measurements with electrode rotation compared with the values obtained in measurements with stationary electrode. Since R_p is inversely proportional to the corrosion current, the decrease in polarization resistance means the increase in corrosion current, i.e. a higher corrosion attack.

Table 3. The values of polarization resistance for the AISI 316L steel in a 0.5 mol dm⁻³ NaCl solution

T/°C	ω/min^{-1}	$R_p/\text{k}\Omega \text{ cm}^{-2}$
20	0	72.903
20	400	42.460
40	0	37.577
40	400	21.997
60	0	19.897
60	400	13.497

Besides the electrochemical measurements, the steel surface was investigated with the optical microscope at different magnifications.

The optical micrographs of the surface of AISI 316L steel are shown in Fig. 5.

The pitting corrosion appears on the surface of the electrode for all investigated conditions. In quiescent solution, pits are randomly placed on the steel surface (Fig. 5 a), b)). The electrode rotation leads to pits grouping on the steel surface (Fig. 5 c), d)), which is more prominent at higher electrolyte temperatures. The increase in temperature of electrolyte leads to the increase in the number of the pits on the steel surface (Fig. 5 e), f)).

It is well known that Cl⁻ ions easily adsorb on the nonhomogenous protective oxide film on metal surface which leads to the local breakdown of the film and the beginning of the pitting corrosion attack. Adsorbed Cl⁻ ions move into metal/oxide film interface at the metal surface. At the particular chloride concentration, a critical potential (E_{pit}) develops which is sufficient to displace oxygen from the protective layer, and the protective layer starts to dissolve. The damage spots on the steel surface act as anodes and the passive surface as cathode which leads to the continuation of corrosion process (Malik et al., 1992).

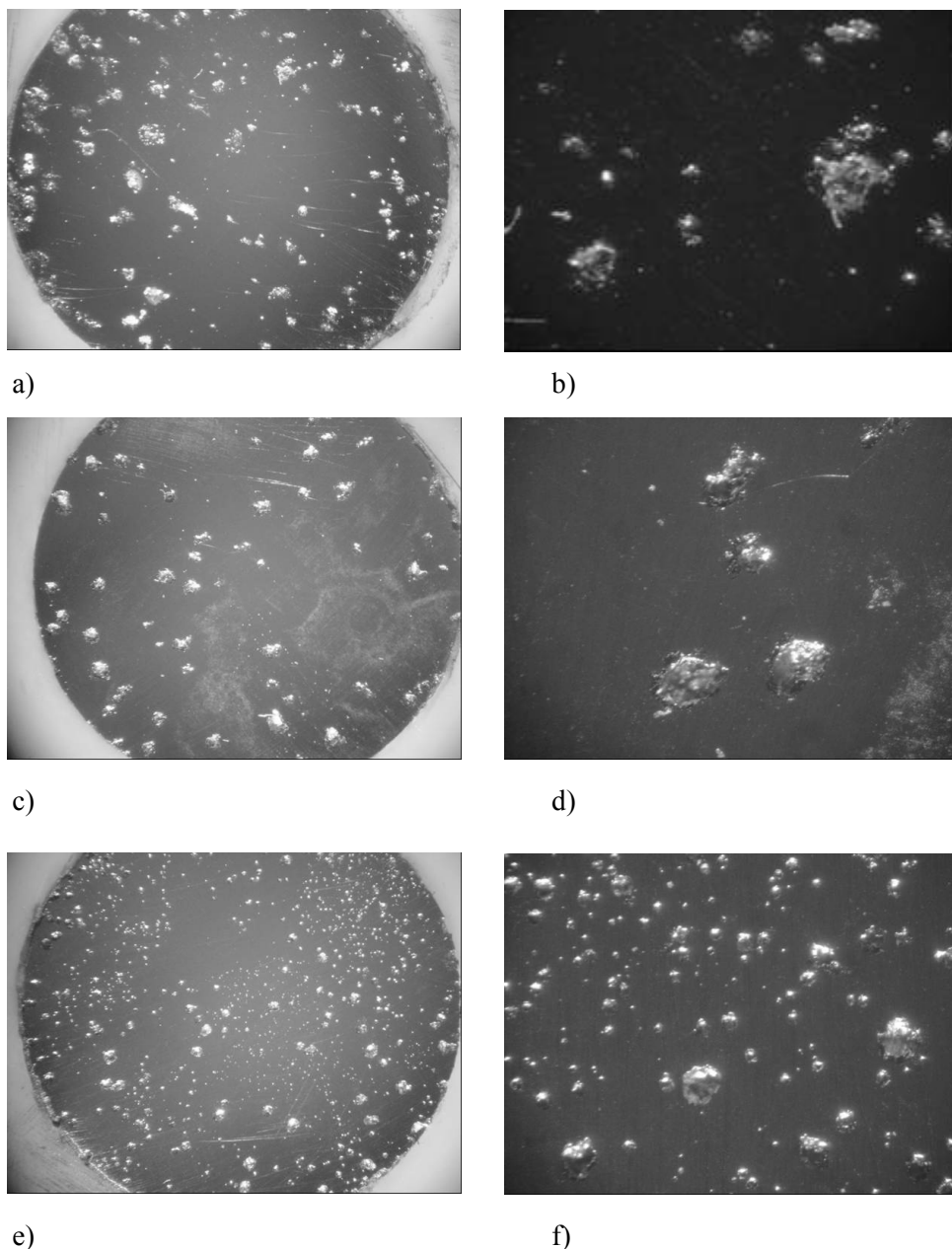

Fig. 5. Optical micrographs of the AISI 316L steel surface after potentiodynamic polarization in 0.5 mol dm^{-3} NaCl solution at 20 °C without electrode rotation, magnification of 25 times a) and 100 times b); at 40 °C and rotation rate of 400 rpm, magnification of 25 times c) and 100 times d); at 60 °C without electrode rotation, magnification of 25 times e) and 100 times f)

Conclusions

- Monitoring the time dependence of the open circuit potential of AISI 316L steel in a 0.5 mol dm⁻³ NaCl solution in the time period of 3 hours, it was determined that the open circuit potential reaches its stable value within 60 minutes. The electrode rotation shifts the stable values of E_{OC} slightly to the anodic direction.
- Potentiodynamic polarization measurements on AISI 316L steel in a 0.5 mol dm⁻³ NaCl solution showed that the increase in the electrolyte temperature leads to the increase in the values of corrosion current densities which means a stronger corrosion attack on the electrode surface. Higher values of corrosion current were obtained in measurements with the electrode rotation.
- Linear polarization measurements have showed that the values of polarization resistance decreased with the increase in electrolyte temperature. Lower values of R_p were obtained in measurements with the electrode rotation, compared with the values of R_p for the measurements with the stagnant electrode.
- Optical microscope images have showed the existence of pitting corrosion on the electrode surface for all investigating conditions. Increasing the electrolyte temperature leads to the increase in the number of the pits which indicates a more intensive development of corrosion process on the steel surface.

Acknowledgement

The authors thank Prof. Dr. Mirko Gojić from the Faculty of Metallurgy Sisak, Croatia, for his technical support.

References

- Kožuh, S., Gojić, M., Kraljić Roković, M. (2008): The effect of PWHT on electrochemical behaviour of AISI 316L Weld Metal, *Chem. Biochem. Eng. Q.* 22 (4), 421-431.
- Kulušić, B., Krstulović, Lj., Ivić, J. (2004): Rupičasta korozija čelika 304L u otopinama klorid iona i prirodnim slanim vodama, *Kem. Ind.* 53 (1), 1-5.
- Malik, A.U., Kutty Mayan, P.C., Siddiqui, A.N., Andijani, N.I., Ahmed, S. (1992): The influence of pH and chloride concentration on the corrosion behaviour of AISI 316L steel in aqueous solutions, *Corros. Sci.* 33 (11) 1809-1827.
- Marcus, P., Olefjord, I. (1988): A round robin on combined electrochemical and AES/ESCA characterization of the passive films on Fe-Cr and Fe-Cr-Mo alloys, *Corros. Sci.* 28 (6), 589-602.
- Matsch, St., Bohni, H. (2000): Influence of temperature on the localized corrosion of stainless steels, *Russ. J. Electrochem.* 36 (10), 1268-1274.
- Pardo, A., Merino, M.C., Coy, A.E., Viejo, F., Arrabal, R., Matykina, E. (2008): Pitting corrosion behaviour of austenitic stainless steels – combining effects of Mn and Mo additions, *Corros. Sci.* 50 (6), 1796-1806.
- Schmit, G. (1995): Hydrodynamic limitations of corrosion inhibitor performance. In: Proc. of the 8th European Symposium of Corrosion Inhibitors, Ann. Univ. Ferrara, N.S., Sez. V. Suppl. N.10; Ferrara, Italy, pp., 1075-1099.

Kontrola kvalitete tijekom proizvodnje šećera iz šećerne repe i sirovog šećera iz šećerne trske

UDC: 664.1 : 658.5

J. Babić^{1*}, Đ. Ačkar¹, N. Drača¹, Lj. Jankuloski²,
M. Jankulovska², V. Brandić³, D. Miličević⁴

¹*Sveučilište Josipa Jurja Strossmayera u Osijeku, Prehrambeno-tehnološki fakultet Osijek, Franje Kuhača 20, Osijek, Hrvatska*

²*Fakultet za poljoprivredne nauke i hranu, Aleksandar Makedonski bb, 1000 Skoplje, Makedonija*

³*LOGWIN, Wien, Austrija*

⁴*Univerzitet u Tuzli, Tehnološki fakultet, Univerzitetska 8, 75000 Tuzla, Bosna i Hercegovina*

Sažetak

U procesu proizvodnje šećera jedan od najvećih problema je uklanjanje nešećernih tvari koje izazivaju negativan učinak kako na kvalitetu šećera tako i na iskorištenje u procesu proizvodnje. Dio navedenih tvari potječe iz sirovine, a dio nastaje tijekom tehnološkog procesa prerade kao posljedica degradacije šećera i drugih sastojaka pod utjecajem uvjeta pri preradi (pH, temperatura,...). Kontrola kvalitete tijekom proizvodnje šećera od iznimne je važnosti jer se time ostvaruju preduvjeti za dobivanje šećera odgovarajuće kvalitete. Cilj rada bio je provesti analizu sirovina, međuproizvoda te finalnog proizvoda u procesu proizvodnje šećera iz šećerne repe te usporediti dobivene rezultate s onima iz procesa proizvodnje šećera iz šećerne trske. U procesu proizvodnje šećera iz šećerne repe analize su provedene na početku kampanje te tijekom trajanja kampanje u rasponu od mjesec dana, a u proizvodnji šećera iz šećerne trske tijekom mjesec dana u rasponu od tjedan dana. Rezultati istraživanja pokazali su da se udio saharoze snižavao se prema kraju kampanje. Vrijednosti koncentracije, polarizacije, koeficijenta čistoće i pH bile su približno jednake za afinirani šećer iz šećerne repe te rafinirani šećer iz smeđeg šećera šećerne trske. Melasa dobivena preradom šećera šećerne trske imala je viši koeficijent čistoće u odnosu na melasu iz proizvodnje šećera iz šećerne repe.

Ključne riječi: proizvodnja šećera, šećerna repa, šećerna trska, kontrola kvalitete

Uvod

Proizvodnja i potrošnja konzumnog šećera (saharoze) u stalnom je porastu te danas iznosi oko 160 milijuna tona godišnje (Asadi, 2007). Šećer koji se nalazi na tržištu proizveden je uglavnom iz šećerne trske i šećerne repe, dok je proizvodnja iz ostalih sirovina zanemariva (Van der Poel i sur., 1998). Kemijski sastav šećerne repe i trske varira ovisno o vrsti, sastavu tla, uvjetima vegetacije, mineralne ishrane, vode, mjerama biljne zaštite i dr. (Pidgeon i sur., 2001;

*jbabac@ptfos.hr

Hoffmann i Märlander, 2005). Količina saharoze u šećernoj repi i trski iznosi 12 do 20 %, a osim saharoze, sadrže i glukozu, fruktozu, celulozu, pektinske tvari, minerale te kiseline, ali u znatno manjim količinama (Oosterveld i sur., 2000; Everingham i sur., 2008).

Konzumni šećer jedan je od glavnih sastojaka svakodnevne prehrane, a prema *Pravilnika o šećerima i metodama analiza šećera namijenjenih za konzumaciju* (39/2009) označava pročišćenu i kristaliziranu saharozu bijele boje vrlo visokog udjela čistoće. Saharozu je disaharid kemijske formule $C_{12}H_{22}O_{11}$ i molekulske mase 342,303 g/mol. Topljiva je u vodi, a topljivost se povećava sa povišenjem temperature i otopljenih primjesa koje ometaju kristalizaciju saharoze (De Brujin, 2000; Langrish i Wang, 2008; Vaccari i sur., 2008). Stoga se otopljeni nešećeri i suspendirane nečistoće uklanjaju u što većoj mjeri u postupku rafinacije sirupa šećerne repe/trske (Grimsey i Herrington, 1996; Yusof i sur., 2000). Saharozu sadrži više asimetričnih ugljikovih atoma i stoga je optički aktivna te skreće ravan polarizirane svjetlosti u desno. Kiseline hidroliziraju saharozu na glukozu i fruktozu (Lu i sur., 2009).

Tehnološki postupak proizvodnje šećera uglavnom je kontinuirani postupak, a odvija se po fazama procesa koje su međusobno povezane u tehnološku cjelinu. U proizvodnji šećera jedan od najvećih problema je uklanjanje nešećernih tvari koje izazivaju negativan učinak kako na kvalitetu šećera tako i na iskorištenje u procesu proizvodnje. Dio navedenih tvari potječe iz sirovine, a dio nastaje tijekom tehnološkog procesa prerade kao posljedica degradacije šećera i drugih sastojaka pod utjecajem uvjeta pri preradi (pH, temperatura,...). Kontrola kvalitete tijekom proizvodnje šećera od iznimne je važnosti jer se time ostvaruju preduvjeti za dobivanje šećera odgovarajuće kvalitete.

Cilj ovog rada bio je provesti analizu sirovina, međuproizvoda te finalnog proizvoda u procesu proizvodnje šećera iz šećerne repe i sirovog šećera iz šećerne trske. Rezultati analiza poslužili su za postavljanje i korigiranje parametara tijekom procesa proizvodnje kako bi se dobio finalni proizvod (konzumni šećer) određene kakvoće, uz maksimalno iskorištenje. Osim toga, uspoređeni su rezultati analiza dobivenih tijekom proizvodnje šećera iz različitih sirovina (iz šećerne repe i sirovog šećera iz šećerne trske). Parametri kvalitete praćeni su tijekom trajanja kampanje, koja je za preradu šećera iz šećerne repe iznosila 4 mjeseca, a za preradu smeđeg tršćanog šećera 4 tjedna.

Materijali i metode

Za određivanje *pH* uzoraka korišten je pH metar (Mettler-Toledo, Švicarska), a za određivanje udjela *suhe tvari* uređaj Brix-Bx (Schmidt + Haensch Dur-Sw, Njemačka).

Određivanje alkaliteta (udjela CaO): 10 ml profiltriranog uzorka otpipetirano je u Erlenmeyer-ovu tikvicu te titrirano sa H_2SO_4 (N/28) uz dodatak indikatora

fenoltaleina do prijelaza crvene boje u bezbojnu. 1 mL utrošenog H₂SO₄ (N/28) odgovara 0,010 % CaO.

Određivanje polarizacije: Uzorak je razrijeđen sa vodom u omjeru 1:1 te je odvagano 52 g u odmjernu tikvicu od 200 mL, dodana je određena količina olovnog acetata, ovisno o uzorku, kako bi se otopina izbistrila. Tikvica je nadopunjena destiliranom vodom do oznake, sadržaj tikvice je promiješan, profiltriran te je određena polarizacija pomoću uređaja Polarotronic (Coloromat Schmidt + Haensch, Njemačka).

Određivanje boje uzoraka: Uzorci tamnijih i vrlo viskoznih sirupa razrijeđeni su sa destiliranom vodom do koncentracije ispod 50 Bx. Melasa je razrijeđena sa destiliranom vodom u omjeru 1:1, od toga je odvagano 2 g u odmjernu tikvicu od 100 mL te nadopunjeno do oznake. Za određivanje boje korišten je IC kolorimetar (Coloromat Schmidt + Haensch, Njemačka).

Rezultati i rasprava

U Tablici 1 prikazani su rezultati analiza udjela pojedinih tvari (saharoze, kalija, natrija, dušika te nečistoća) u šećernoj repi tijekom trajanja kampanje (četiri mjeseca). Kontrola kvalitete šećerne repe ima poseban značaj za optimizaciju tehnološkog postupka prerade kako bi se dobio proizvod određene kvalitete uz maksimalno iskorištenje. U prva tri mjeseca udio saharoze u repi bio je približno konstantan (na početku kampanje 15,68 %, u drugom mjesecu 15,48, a u trećem 15,99 %), dok se na kraju kampanje snizio na 15,15 %. Sniženje udjela saharoze u repi posljedica je dužeg vremena skladištenja. Naime, nakon vađenja šećerne repe biokemijski procesi u korijenu dalje se nastavljaju te uzrokuju razgradnju sharoze i promjene u sastavu (Bugbee and Cole, 1979). Sadržaj ostalih tvari u šećernoj repi (kalija, natrija te dušika) tijekom kampanje nije se značajnije mijenjao.

U Tablici 2 dani su rezultati svojstava rijetkog soka šećerne repe dobivenog procesom difuzije. Na početku i na kraju kampanje udio suhe tvari u difuznom soku, izražen u Bx, bio je nešto niži (13,63 na početku, odnosno 13,57 Bx na kraju kampanje), dok je tijekom drugog (14,61 Bx) i trećeg mjeseca (15,53 Bx) bio viši. Udio saharoze u difuznom soku kretao se tijekom kampanje od 12,63 do 14,23 %. Pri tome je udio saharoze u difuznom soku na početku i na kraju kampanje bio niži (12,63 te 12,92 %), a tijekom II. i III. mjeseca viši (13,48 te 14,23 %).

Kvocijent čistoće (Q) i pH difuznog soka bio je približno jednak tijekom četiri mjeseca prerade šećerne repe. Tako se kvocijent čistoće kretao u rasponu 92,0-92,63, a pH=9,04-9,16. Difuzni sok na početku kampanje imao je je niže vrijednosti boje koja je iznosila oko 1788 ICUMSA jedinica, dok je kasnije došlo do povišenja vrijednosti boje koja se kretala u rasponu 1977-2068 ICUMSA jedinica. Ova pojava posljedica je smanjenja kakvoće šećerne repe tijekom skladištenja (razgradnja saharoze, smrzavanje repe, djelovanje mikroorganizama, i dr.).

Tablica 1. Udio pojedinih tvari u šećernoj repi. Analize su provedene prilikom dovoza šećerne repe u krug tvornice

Table 1. Sugar beet content. Beet sampling is performed automatically from sugarbeet loads

	Saharoza (%)	Kalij (%)	Natrij (%)	Dušik (%)	Nečistoće (%)
Početak Kampanje*	15,680	3,460	0,680	2,730	14,940
II. mjesec Kampanje*	15,480	3,510	0,870	2,860	14,690
III. mjesec Kampanje*	15,990	3,680	1,030	2,640	14,250
Kraj Kampanje*	15,150	3,190	0,460	2,250	19,550

*Prikazani rezultati su srednje vrijednosti analiza prvog dana u mjesecu kroz sve tri smjene.

Tablica 2. Svojstva rijetkog soka šećerne repe dobivenog procesom difuzije

Table 2. Properties of sugar beet juice obtained in diffusion process

	Bx	P	Q	pH	Ca-soli	IC
Početak Kampanje*	13,63	12,63	92,59	9,16	0,104	1788
II. mjesec Kampanje*	14,62	13,48	92,18	9,12	0,067	2068
III. mjesec Kampanje*	15,53	14,23	92,63	9,09	0,077	2012
Kraj Kampanje*	13,57	12,92	92,00	9,04	0,088	1977

*Prikazani rezultati su srednje vrijednosti analiza prvog dana u mjesecu kroz sve tri smjene. Bx-koncentracija u Bx, P-polarizacija, Q-kvocijent čistoće, Ca-soli (%), IC-boja prema ICUMSA metodi.

U Tablici 3 prikazani su rezultati svojstava rijetkog soka smeđeg šećera iz šećerne trske (*majšovani sirup*). Sirovi smeđi šećer iz šećerne trske se otapa u vodi te miješa sa I i II. sirupom izdvojenim tijekom centrifugiranja pri čemu se dobije tzv. majšovani sirup. Osnovna razlika u sastavu između sirovog šećera iz šećerne trske i šećera iz šećerne repe je u sastavu invertnog šećera (ekvimolarna smjesa glukoze i fruktoze koja nastaje razgradnjom saharoze). Sirovi šećer iz šećerne trske sadrži oko 1,5 % invertnog šećera, dok onaj iz šećerne repe sadrži oko 0,05 % (Van der Poel i sur., 1998).

Tablica 3. Svojstva rijetkog soka smeđeg šećera iz šećerne trske (majšovani sirup)

Table 3. Properties of raw juice of brown sugar from sugar cane

	Bx	P	Q	pH	IC
I. tjedan*	58,6533	58,4633	99,6767	8,0333	839
II. tjedan*	58,6900	58,4467	99,5933	7,8600	859
III. tjedan*	59,1067	58,0933	99,1667	7,7300	1067
IV. tjedan*	58,7233	58,2767	99,7300	7,8900	1113

*Prikazani rezultati su srednje vrijednosti analiza prvog dana u mjesecu kroz sve tri smjene. Bx-koncentracija u Bx, P-polarizacija, Q-kvocijent čistoće, IC-boja prema ICUMSA metodi.

Tablica 4. Svojstva rijetkog soka šećerne repe tijekom I-alkalizacije i II-alkalizacije
Table 4. Properties of sugar beet raw juice during I-alkalization and II-alkalization

I-alkalizacija	CaO (%)	pH
Početak Kampanje*	2,76	11,03
II. mjesec Kampanje*	2,08	11,0
III. mjesec Kampanje*	2,08	10,94
Kraj Kampanje	2,76	11,05
II-alkalizacija		
Početak Kampanje*	0,078	9,23
II. mjesec Kampanje*	0,029	9,06
III. mjesec Kampanje*	0,030	9,01
Kraj Kampanje*	0,030	8,97

*Prikazani rezultati su srednje vrijednosti analiza prvog dana u mjesecu kroz sve tri smjene.

U Tablicama 4 i 5 prikazani su rezultati analize rijetkog soka šećerne repe te rijetkog soka smeđeg šećera iz šećerne trske tijekom I- i II-alkalizacije. Tijekom I-alkalizacije rijetkog soka šećerne repe dodaje se veća količina $\text{Ca}(\text{OH})_2$ (oko 2 % CaO) pri čemu se pH povisuje na oko 11. S druge strane, tijekom II-alkalizacije rijetkog soka smeđeg šećera iz šećerne trske dodaje se oko 1,3% CaO (pH oko 9). Rijetkom soku šećerne repe dodaje se veća količina $\text{Ca}(\text{OH})_2$ iz razloga što sadrži znatno više nečistoća, naročito proteina, u odnosu na rijetki sok smeđeg šećera iz šećerne trske. Proteini u rijetkom soku šećerne repe imaju koagulacioni optimum pri pH oko 11 (Van der Poel i sur., 1998).

Tablica 5. Svojstva rijetkog soka smeđeg šećera iz šećerne trske tijekom I-alkalizacije i II-alkalizacije

Table 5. Properties of raw juice of brown sugar from sugar cane during I-alkalization and II-alkalization

I-alkalizacija	CaO (%)	pH
I. tjedan*	1,38	9,06
II. tjedan*	1,22	8,98
III. tjedan*	1,25	8,82
IV. tjedan*	1,30	9,21
II-alkalizacija		
I. tjedan*	0,0433	8,92
II. tjedan*	0,0300	9,09
III. tjedan*	0,0367	8,91
IV. tjedan*	0,0200	8,81

*Prikazani rezultati su srednje vrijednosti analiza prvog dana u tjednu kroz sve tri smjene.

Nakon provedbe I-alkalizacije i uklanjanja istaloženih nečistoća filtracijom slijedi II-alkalizacija. Tijekom II-alkalizacije rijetkom soku šećerne repe dodaje se, također veća količina $\text{Ca}(\text{OH})_2$, u odnosu na rijetki sok smeđeg šećera iz šećerne trske. Međutim, ta razlika je znatno manja nego kod I-alkalizacije iz razloga što je i razlika u sadržaju nečistoća manja. Tako se rijetkom soku šećerne repe dodaje 0,029-0,070 % CaO , a rijetkom soku smeđeg šećera iz šećerne trske 0,020-0,043 % CaO .

Tablica 6. Svojstva soka šećera iz šećerne trske nakon provedbe procesa čišćenja
Table 6. Properties sugar cane juice after cleaning process

	Bx	P	Q	pH	IC
I. tjedan*	64,23	64,13	99,84	8,85	481
II. tjedan*	67,39	67,16	99,65	8,77	604
III. tjedan*	65,20	65,49	99,48	8,60	464
IV. tjedan*	64,53	64,20	99,53	9,01	611

*Prikazani rezultati su srednje vrijednosti analiza prvog dana u tjednu kroz sve tri smjene. Bx-koncentracija u Bx, P-polarizacija, Q-kvocijent čistoće, IC-boja prema ICUMSA metodi.

U Tablicama 6 i 7 prikazana su svojstva gustog soka šećerne repe nakon provedbe procesa čišćenja i uparavanja, te soka šećera iz šećerne trske nakon provedbe procesa čišćenja. Kvocijent čistoće (Q) i boja između gore navedena dva soka znatno su se razlikovali dok su ostali parametri (koncentracija, polarizacija i pH) bili približno jednake vrijednosti. Sok iz šećerne repe imao je znatno više vrijednosti boje koje su se kretale u rasponu od 2331-2659 ICUMSA jedinica (sok šećera šećerne trske IC=464-611 ICUMSA jedinica) te niži kvocijent čistoće 91,83-92,67 (sok šećera šećerne trske Q=99,48-99,84).

Tablica 7. Svojstva gustog soka šećerne repe nakon provedbe procesa čišćenja i uparavanja
Table 7. Properties of sugar beet juice after cleaning and evaporation process

	Bx	P	Q	pH	IC
Početak Kampanje*	65,45	60,66	92,67	8,69	2447
II. mjesec Kampanje*	67,35	61,95	91,99	8,55	2659
III. mjesec Kampanje*	66,84	61,86	92,55	8,35	2390
Kraj Kampanje*	67,50	61,99	91,83	8,25	2331

*Prikazani rezultati su srednje vrijednosti analiza jednog dana u mjesecu kroz sve tri smjene. Bx-koncentracija u Bx, P-polarizacija, Q-kvocijent čistoće, IC-boja prema ICUMSA metodi.

U Tablici 8 prikazane su vrijednosti analiza konzumnog šećera iz šećerne repe te iz smeđeg šećera šećerne trske (udio vode, pepeo, polarizacija, pH te udio SO_2). Vidljivo je da su ispitivani uzorci imali približno jednake vrijednosti navedenih parametara:

- Udio vode; konzumni šećer iz šećerne repe od 0,014 do 0,031 % te konzumni šećer iz smeđeg šećera šećerne trske od 0,0273 do 0,0283 %.
- Udio pepela; konzumni šećer iz šećerne repe od 0,09 do 0,013 % te konzumni šećer iz smeđeg šećera šećerne trske od 0,09 do 0,012 %.
- Polarizacija; konzumni šećer iz šećerne repe od 99,92 do 99,94 % te konzumni šećer iz smeđeg šećera šećerne trske od 99,91 do 99,93 %.
- pH; konzumni šećer iz šećerne repe od 6,60 do 6,76 % te konzumni šećer iz smeđeg šećera šećerne trske od 6,62 do 6,71 %.
- Udio SO₂; konzumni šećer iz šećerne repe od 0,027 do 0,10 % te konzumni šećer iz smeđeg šećera šećerne trske od 0,03 do 0,94 %.

Iz gore navedenih rezultata vidljivo je da proizvedeni konzumni šećer iz šećerne repe te konzumni šećer iz smeđeg šećera šećerne trske udovoljavaju *Pravilnika o šećerima i metodama analiza šećera namijenjenih za konzumaciju* (39/2009).

Saharoza se iz sirupa izdvaja kroz više ciklusa kristalizacije, čišćenja i centrifugiranja. Nakon *završnog* ciklusa izdvajanja kristala saharoze zaostaje vrlo viskozni, tamni sirup koji se naziva melasa (nus proizvod u proizvodnji šećera). S obzirom na šećernu repu nastaje oko 5 % melase (Asadi, 2007). U Tablici 9 prikazana su svojstva melase iz procesa proizvodnje šećera iz šećerne repe te iz proizvodnje šećera iz smeđeg šećera šećerne trske. Iz rezultata je vidljivo da melasa iz procesa proizvodnje šećera iz šećerne repe ima višu koncentraciju (81,59-83,26°Bx), a nižu vrijednost boje (446-568 ICUMSA jedinica) u odnosu na melasu iz proizvodnje šećera iz smeđeg šećera šećerne trske. Koncentracija melase iz proizvodnje šećera iz smeđeg šećera šećerne trske kretala se u rasponu 71,06-78,72°Bx, kvocijent čistoće 65,86-70,46 te boja 808-914 ICUMSA jedinica.

Tablica 8. Svojstva proizvedenog konzumnog šećera iz šećerne repe te konzumnog šećera iz smeđeg šećera šećerne trske

Table 8. Properties of refined sugar produced from sugar beet and sugar cane brown sugar

	Udio vode (%)	Pepeo (%)	Polarizacija	pH	SO ₂ (%)
<i>Konzumni šećer iz šećerne repe</i>					
Početak Kampanje	0,031	0,013	99,94	6,60	0,027
II. mjesec Kampanje	0,023	0,009	99,92	6,67	0,027
III. mjesec Kampanje	0,014	0,011	99,92	6,76	0,090
Kraj Kampanje	0,017	0,010	99,92	6,70	0,108
<i>Konzumni šećer iz smeđeg šećera šećerne trske</i>					
I. tjedan	0,0273	0,011	99,93	6,64	0,030
II. tjedan	0,0283	0,012	99,92	6,71	0,038
III. tjedan	0,0273	0,009	99,91	6,62	0,078
IV. tjedan	0,0277	0,012	99,92	6,64	0,940

Tablica 9. Svojstva melase iz procesa proizvodnje šećera iz šećerne repe te iz proizvodnje šećera iz smeđeg šećera šećerne trske

Table 9. Properties of molasses produced from sugar beet and sugar cane brown sugar

	Bx	P	Q	pH	IC
Melasa iz procesa proizvodnje šećera iz šećerne repe					
Početak Kampanje*	82,06	51,65	62,89	7,17	446
II. mjesec Kampanje*	83,26	49,18	59,07	7,31	510
III. mjesec Kampanje*	82,92	48,89	58,97	7,42	544
Kraj Kampanje*	81,59	53,06	65,02	7,13	568
Melasa iz procesa proizvodnje šećera iz smeđeg šećera šećerne trske					
I. tjedan*	78,72	53,38	67,81	7,05	808
II. tjedan*	71,06	50,07	70,46	7,71	914
III. tjedan*	77,42	52,07	65,86	6,31	716
IV. tjedan*	75,72	50,90	67,22	7,06	833

Bx-koncentracija u Bx, P-polarizacija, Q-kvocijent čistoće, IC-boja prema ICUMSA metodi.

Melase su sadržavale 48,89-53,38 % šećera. Kao što je vidljivo, u melasi zaostaje relativno velika količina saharoze koja se ne može izdvojiti kristalizacijom zbog visokog udjela nešećera (oko 30 %). Ovo je posljedica svojstva saharoze čija se topljivost povećava s povišenjem udjela nečistoća. Melasa predstavlja 80 % gubitka saharoze s obzirom na ukupne gubitke šećera. Melasa nastala preradom šećera šećerne trske imala je viši Q koji se kretao u rasponu 65,86-70,46 (iz šećerne repe 58,97-65,02). Melasa iz šećerne trske sadrži viši udio invertnog šećera i ima bolja organoleptička svojstva te se, između ostalog, koristi u proizvodnji smeđeg šećera.

Zaključak

Udio saharoze u šećernoj repi tijekom prva tri mjeseca kampanje kretao se u rasponu od 15,48 do 15,99 %, a pri kraju se snizio na 15,15 %. Osim toga, pri kraju kampanje došlo je do znatnog povećanja udjela nečistoća u šećernoj repi. Udio saharoze u difuznom soku tijekom kampanje kretao se od 12,63 do 14,23 % Pri tome je udio saharoze u difuznom soku na početku i na kraju kampanje bio niži, a tijekom II. i III. mjeseca viši.

Tijekom I- i II-alkalizacije rijetkog soka šećerne repe dodaje se veća količina CaO, u donosu na I- i II-alkalizaciju rijetkog soka smeđeg šećera iz šećerne trske gdje se dodaje oko 1,3 % CaO. Rijetkom soku šećerne repe dodaje se veća količina CaO iz razloga što sadrži znatno više otopljenih nešećera. Melase iz procesa proizvodnje šećera iz šećerne repe te iz proizvodnje šećera iz smeđeg šećera šećerne trske sadržavale su 48,89-53,38 % šećera.

Proizvedeni konzumni šećer iz šećerne repe te konzumni šećer iz smeđeg šećera šećerne trske udovoljavaju *Pravilniku o šećeru i ostalim saharidima, njihovim otopinama te škrobu i škrobnim sirupima*.

Zahvala

Prizakani rezultati proizašli su iz znanstvenog projekta „Razvoj novih modificiranih škrobova i primjena u prehrambenoj industriji“, provedenog uz potporu Ministarstva znanosti, obrazovanja i športa Republike Hrvatske.

Literatura

- Asadi, M. (2007): Beet sugar-Handbook. Wiley Interscience, New Jersey, SAD.
- Bugbee, W. M. Cole D.F. (1979): Comparison of Thiabendazole and Genetic Resistance for Control of Sugar Beet Storage Rot, *Phytopathology*. 69, 1230-1232.
- De Bruijn, J.M. (2005): Impact of beet quality on sugar manufacture and technological criteria for further quality improvement, *Inter. Sugar J.* 107, 554-559.
- Everingham, Y.L. Smyth, C.W., Inman-Bamber, N.G. (2008): Ensemble data mining approaches to forecast regional sugarcane crop production, *Agric.l. and Forest Meteorology*. 149, 18-24.
- Grimsey, I.M., Herrington, T.M. (1996): The incorporation of colored compounds in sucrose crystals, *Zuckerindustrie*. 121, 40-45.
- Hoffmann, C. M. Märlander B. (2005): Composition of harmful nitrogen in sugar beet (*Beta vulgaris* L.)-amino acids, betaine, nitrate-as affected by genotype and environment, *Europ. J. Agronomy*. 22, 255-265.
- Lu, E., Ewing, S., Gatlin, L., Suryanarayanan, R., Shalaev, E. (2009): The effect of bulking agents on the chemical stability of acid-sensitive compounds in freeze-dried formulations: Sucrose inversion study, *J. Pharm Sci.* 98, 3387-3396.
- Langrish, T.A.G., Wang, S. (2008): Crystallization rates for amorphous sucrose and lactose powders from spray drying: A comparison, *Drying Technol.* 27, 606-614.
- Oosterveld, A., Henk, G. B., Schols, A. Voragen G.J. (2000): Characterization of arabinose and ferulic acid rich pectic polysaccharides and hemicelluloses from sugar beet pulp, *Carbohydr. Res.* 328, 185-197.
- Pravilnika o šećerima i metodama analiza šećera namijenjenih za konzumaciju (39/2009), 2009.
- Pidgeon, J.D., Werker, A.R., Jaggard, K.W., Richter, G.M., Lister, D.H., Jones, P.D. (2001): Climatic impact on the productivity of sugar beet in Europe, 1961-1995, *Agric. and Forest Meteorology*. 109, 27-37.
- Van der Poel, P.W., Schieweck, H. Schwartz, T. (1998): Sugar technology. Verlag, Berlin, Njemačka.
- Vaccari, G., Sgualdino, G., Tamburini, E., Pezzi, G., Citterio, P., Verardi, P. (2008): New proposal for sucrose crystallization from raw juice, *Zuckerindustrie*. 128, 821-828.
- Yusof, S., Shian, L.S. Osman, A. (2000): Changes in quality of sugar-cane juice upon delayed extraction and storage, *Food Chem.* 68, 395-401.

Quality control during refining sugar from sugar beet and raw brown sugar from sugar cane

J. Babić¹, Đ. Ačkar¹, N. Drača¹, Lj. Jankuloski²,
M. Jankulovska², V. Brandić³, D. Miličević⁴

¹*University of Josip Juraj Strossmayer in Osijek, Faculty of Food Technology Osijek, Franje Kuhača 20, Osijek, Croatia*

²*Faculty of Agricultural Sciences and Food, Aleksandar Makedonski bb, 1000 Skoplje, Macedonia*

³*LOGWIN, Wien, Austrija*

⁴*Tuzla University, Faculty of Technology, Univerzitetska 8, 75000 Tuzla, Bosnia and Herzegovina*

Summary

Production and consumption of sugar is increasingly growing and today it totals around 150 million tons per year. Sugar on the market is mostly produced from sugar beet and sugar cane. Quality control during sugar production is crucial, since it enables production of high quality sugar. The aim of this research was to conduct analyses of raw materials, semi-products and final products in the production of sugar from sugar beet and raw sugar from sugar cane. In addition, results of analyses conducted during sugar production from different raw materials (sugar beet and sugar cane) were compared. During production of sugar from sugar beet, analyses were conducted at the beginning of the campaign and every month during campaign, while during production of sugar from sugar cane analyses were conducted every week during one month period. Results showed that sucrose content decreased towards the end of campaign. Concentration, polarisation, purity and pH values were similar for afinated sugar from sugar beet and afinated sugar from brown cane sugar. Molasses from sugar cane had higher purity compared to molasses from sugar beet. Quality analysis of consumption sugar showed that sugar was produced in accordance with quality requirements.

Keywords: sugar production, sugar beet, sugar cane, quality control

Influence of freeze-drying and microencapsulation on the functionality of probiotic strains in the intestinal tract

UDC: 637.146.1 : 579.67
637.146.1 : 611.3

J. Beganović, B. Kos, A. Leboš Pavunc, K. Habjanič,
M. Ogorelec, J. Šušković*

Laboratory for Antibiotic, Enzyme, Probiotic and Starter Cultures Technology, Faculty of Food Technology and Biotechnology, University of Zagreb, Pierottijeva 6, 10000 Zagreb, Croatia

Summary

In order to exert the probiotic activity in the human intestinal tract, probiotic preparations need to contain 10^6 - 10^8 viable cells per gram of the product. Therefore, freeze-drying of the wet cell biomass, with the different lyoprotectors was performed, with the aim to produce probiotic strains *Lactobacillus helveticus* M92, *Lactobacillus plantarum* L4 and *Enterococcus faecium* L3 in the powder form with the high viable cell count for the application as biotherapeutics. Skim milk and inulin have shown as optimal lyoprotectors between tested ones, as higher viability of probiotic cells was achieved after the freeze-drying compared to control and other lyoprotectors. The viable cell count of probiotic strains, after freeze-drying in skim milk, was above 10^7 CFU/g, during 1 year of storage at 4 °C what is in accordance with the claims set up for the probiotic products. Another approach for increasing the viable cell number of probiotic strains, during freeze-drying and storage as well as for an oral target delivery, could be microencapsulation. Hence, the microencapsulation of wet biomass and freeze-dried bacteria cells of *L. helveticus* M92, *L. plantarum* L4 and *E. faecium* L3 were evaluated. The microencapsulation of probiotic cells was performed in alginate, κ -carrageenan and by transglutaminase-induced gelatination of caseinate in order to investigate the effect of the microencapsulation on the functionality of probiotic strains. The higher percentage of the survival of microencapsulated cells of *L. helveticus* M92, *L. plantarum* L4 and *E. faecium* L3 compared to the percentage of the survival of non-microencapsulated probiotic cells, in simulated gastrointestinal tract conditions, indicates the protective effect of the microencapsulation on the probiotic strains.

Keywords: freeze-drying, microencapsulation, oral delivery, probiotics, simulated gastrointestinal tract conditions

Introduction

Lactobacillus helveticus M92, *Lactobacillus plantarum* L4 and *Enterococcus faecium* L3 have been previously isolated and characterized, as probiotic strains

*.jsusko@pbf.hr

in Laboratory of Antibiotic, Enzyme, Probiotic and Starter culture Technology on Faculty of Food Technology and Biotechnology University of Zagreb (Šušković, 1996; Kos et al., 2000; Šušković et al., 2000; Kos, 2001; Kos et al., 2003; Frece et al. 2005, Beganović; 2008; Frece et al., 2009). Besides their application as functional starter cultures for the various fermented food products, there is also a great potential for their application as bioterapeutics (Kos et al., 2008; Šušković et al., 2010). According to the definition of the World Health Organization (2001), probiotics are living microorganisms which, when administered in adequate amounts, confer a health benefit on the host. For the optimal functionality probiotics in the final product should remain metabolically stable and active, surviving passage through the gastrointestinal tract (GIT) (Gilliland 1989). Moreover, in order to exert health benefits, probiotic bacteria are expected to be at the level of $10^6 - 10^8$ CFU of live microorganisms per millilitre or gram of product (Guarner and Schaafsma, 1998; Shah 2000). Probiotic cell concentrates are often required to be stored over longer periods prior to food manufacture and ingestion (Carvalho et al., 2004; De Giulio et al., 2005). During processing and storage, probiotic cells are exposed to the number of stress factors such as high temperatures, low pH, high osmotic pressure and high levels of oxygen (Gardiner et al., 2000; Prasad et al., 2003). The survival of probiotic is also affected by low pH values encountered in the stomach and the high concentrations of bile salts in the intestine tract (Conway et al., 1987, Chandramouli et al., 2004). Recently, many studies showed the potential of microencapsulation to improve probiotic survival during storage or introduction in food products (Ouweland et al, 2002; Anal and Singh, 2007; Champagne and Fustier, 2007; Heidebach et al., 2009; Leboš Pavunc et al., 2010). Also, freeze-drying is considered as one of the most suitable between dehydration processes for the bacteria which provides a solid and stable final probiotic formulation. Here, the choice of an appropriate lyoprotector is very important to achieve increased survival rates during dehydration and storage (Carvalho et al., 2004). This study was designed to find the most suitable matrix for the microencapsulation of probiotic bacteria *L. helveticus* M92, *L. plantarum* L4 and *E. faecium* L3 to improve cell viability during gastrointestinal challenge. This considers the delivered of probiotics to a host i.e. GIT at high viable cell number, in order to exert their health benefits, in the form of microencapsulated wet biomass or in the powder form performed by freeze-drying. Hence, wet biomass of *L. helveticus* M92, *L. plantarum* L4 and *E. faecium* L3 was firstly freeze-dried with the addition of the different lyoprotectors to evaluate the most suitable protective agent to obtain the highest cell survival after the lyophilisation and during the storage.

Materials and Methods

Materials

Probiotic strains *Lactobacillus helveticus* M92, *Lactobacillus plantarum* L4 and *Enterococcus faecium* L3 are from the Culture Collection of the Laboratory of Antibiotic, Enzyme, Probiotic and Starter Cultures Technology, University of Zagreb. All strains were stored at -80 °C in the De Mann Rogosa Sharpe (MRS) broth (Biolife, Italy) with 30 % (v/v) glycerol. Before the experimental use, probiotic cultures were sub-cultured twice in the MRS broth.

Freeze-drying with different lyoprotectors

Late exponential phase probiotic cells (12 h) grown in MRS medium were freeze-dried using a variety of cryoprotective agents at 5 % (w/v), including sucrose, lactose, prebiotic inulin and sorbitol (Kemika), and in the 10 % skim milk (Dukat, Croatia), while suspension of probiotic cells in phosphate buffer (pH 6) was used as control. The bacterial cultures were centrifuged for 15 min at 3300 g. The supernatants were discarded and the cells were washed twice and resuspended in 5 ml of phosphate buffer (pH 6) with or without addition of cryoprotector. The suspensions were then frozen at -80 °C for 12 h. Freeze-drying of the frozen cultures in Braun Biotech International, model Christ Alpha 1-2 LD freeze drier during 45 h followed. Viable cells count (CFU/ml), both before and after freeze-drying, were determined, by colony formation on MRS agar using the standard pour-plating method. Each experiment was conducted in triplicate.

The freeze-drying yield was calculated according to following expression:

$$FY (\%) = \frac{\log N}{\log N_0} \times 100$$

where N is viable cell count (CFU/ml) after freeze-drying, and N_0 is viable cell count (CFU/ml) in wet biomass before freeze-drying.

Microencapsulation of probiotic cells

Probiotic cells preparation for microencapsulation

A probiotic cell suspension was prepared by centrifuging 50 ml of an overnight culture at 3300 g and washed twice before microencapsulation.

Microencapsulation in alginate

Microencapsulation of probiotic cells was performed as described by Truelstrup Hansen et al. (2002) with modifications. 3.0 % alginate (Fluka) was chosen as the supporting material. Probiotic cells suspension was mixed with a 3.0 % Na-alginate solution to form capsules. The alginate-bacteria mix was subsequently emulsified in 10 g vegetable oil containing 5 g/l Tween 80 (Sigma) using a magnetic stirrer set at approximately 300 rpm for 20 min. Gelation was initiated by the addition of 32ml Ca²⁺-containing emulsion (6 g vegetable oil, 5 g/l Tween 80 and 62.5mM CaCl₂). The alginate microspheres were formed during continuous stirring for 20 min. Pepton saline (4 ml) with CaCl₂ (0.05 M) was added and the alginate microspheres were harvested.

Microencapsulation in κ -carrageenan

Microencapsulation in κ-carrageenan was performed according to Oser et al. (2009). The probiotic cells were resuspended in 10 ml of sterile PBS. Afterwards, the cell suspension was added to 2.0 % (w/v) κ -carrageenan (60 ml, supporting material), containing 0.9 % NaCl, and tempered at 47 °C. The continuous phase and the emulsifying agent were sunflower oil (100 ml) and Tween-80 (0.1 %, v/v) (Merck), respectively. The mixture of the oil and Tween-80 was stirred at the lowest speed at 40 °C for 5 min. The capsule formation was achieved by adding the cell suspension/κ -carrageenan mixture quickly into the oil/Tween-80 mixture. To break the emulsion, 1 M CaCl₂ (150 ml) was added. The oil phase was removed and the capsules containing bacterial cells were separated from the CaCl₂ solution by centrifuging at 350 g for 10 min. The capsules were washed twice with sterile saline solution and stored at 4 °C.

Transglutaminase induced caseinate microencapsulation

Microencapsulation of probiotic cells in caseinate was performed according modified method of Heidebach et al. (2009) using 15 % (w/w) casein sodium salt from bovine milk (Sigma), transglutaminase (TGase) ACTIVA[®] YG (100 U/g) (Ajinomoto) and sunflower oil purchased from a local store. TGase was added to the protein cell mixture with an enzyme concentration of 10 U TGase per g substrate protein at 40 °C. Directly after TGase addition, the protein–cell mixture, containing probiotic cells, was added to 15 g of tempered (40 °C) sunflower oil and stirred at a constant speed of 900 rpm for 2h. During the process the emulsified droplets of protein–cell mixture were converted into gel particles. Subsequently, the gelatinized microcapsules were separated overnight from the oil in separating funnel. The supernatant was removed and the sediment was diluted with twice its amount of physiological solution, shaken for 5 min and then separated again using the same conditions. The supernatant, consisting of water and residual oil was removed. Oil free microcapsule-slurry was stored at 4 °C and experiments in simulated GIT conditions were performed.

Calculation of microencapsulation yield

Microencapsulation yield (EY) was calculated as follows (Annan et al., 2008):

$$EY (\%) = \frac{\log N}{\log N_0} \times 100$$

where N is viable cell count (CFU/ml) released from microspheres, and N_0 is viable cell count (CFU/) in wet biomass added to the microencapsulation matrix for the preparation of microspheres.

Survival of the probiotic cells in the simulated gastrointestinal conditions

Simulated gastric and small intestinal juices were prepared according to Kos et al., (2000). Briefly, simulated gastric was prepared by dissolving pepsin (3 g/l) in sodium chloride solution (0.5 %) adjusting the pH to 2.0 with concentrated HCl. Simulated intestinal juice was prepared by suspending pancreatin (1 g/l) and bile salts (3 mg/ml oxgall) in sodium chloride solution (0.5 %) and pH was adjusted to 8.0 with 0.1 M NaOH. Both gastric and intestinal juices were prepared fresh for use on the same day. Washed cell suspensions of probiotic cells (0.5 ml) or 0.5 g of microspheres with entrapped bacteria were added to 4.5 ml of tempered (37 °C) simulated gastric juice, mixed well and incubated for 1h at 37 °C. The cells were then separated by centrifugation and added in simulated intestinal juice tempered at 37 °C and incubated for 1, 2, 3, 4 hours at 37 °C with periodical shaking. Surviving bacteria after set times were enumerated by pour plating method on MRS agar at 37 °C for 72 h as described above.

Results and Discussion

The successful application of the probiotics strongly depends on the production technology. Freeze-drying is the one of the most advantageous techniques used to obtain long term metabolically stable probiotic cultures from the aspects of viability and functionality (Otero et al., 2007; Pekkonen et al., 2008). Hence, in order to select the optimal lyoprotector, the viability of the three different probiotic strains after the freeze-drying in different protective agents was investigated. The results indicate that the viability of probiotic cells *L. helveticus* M92, *L. plantarum* L4 and *E. faecium* L3 can be improved by the addition of appropriate type and concentration of carbohydrate, but also commonly used cryoprotectant, skim milk. Viability of the probiotic cells, after freeze-drying, was significantly improved when skim milk was used as protective agent (cell viability > 90 %) (Fig.1). This is due to the protective influence of skim milk

that prevents bacterial cell from lysis by stabilizing cell membrane constituents, creates porous structure in the freeze-dried product that makes rehydration easier and contains proteins that provide a protective coating for the cells (Kos et al., 2000; Kos, 2001; Carvalho et al., 2004). In addition, the freeze-drying of *L. helveticus* M92 and *L. plantarum* L4, performed with prebiotic substrate inulin, appeared to be the most effective (Fig. 1, a-b). The sugars lactose and sucrose, as well as a sugar alcohol sorbitol, positively influenced cell viability during freeze-drying compared to control (Fig. 1) Such compatible cryoprotectants accumulate within the bacterial cells and contribute to the reduction of the osmotic difference between bacterial cell and external microenvironment (Capela et al., 2006). The protective effect of skim milk during 1 year storage of freeze-dried cells *L. helveticus* M92, *L. plantarum* L4 and *E. faecium* L3 is shown at Table 1. The viable cell count was above 10^7 CFU/ml during whole period of storage at 4 °C.

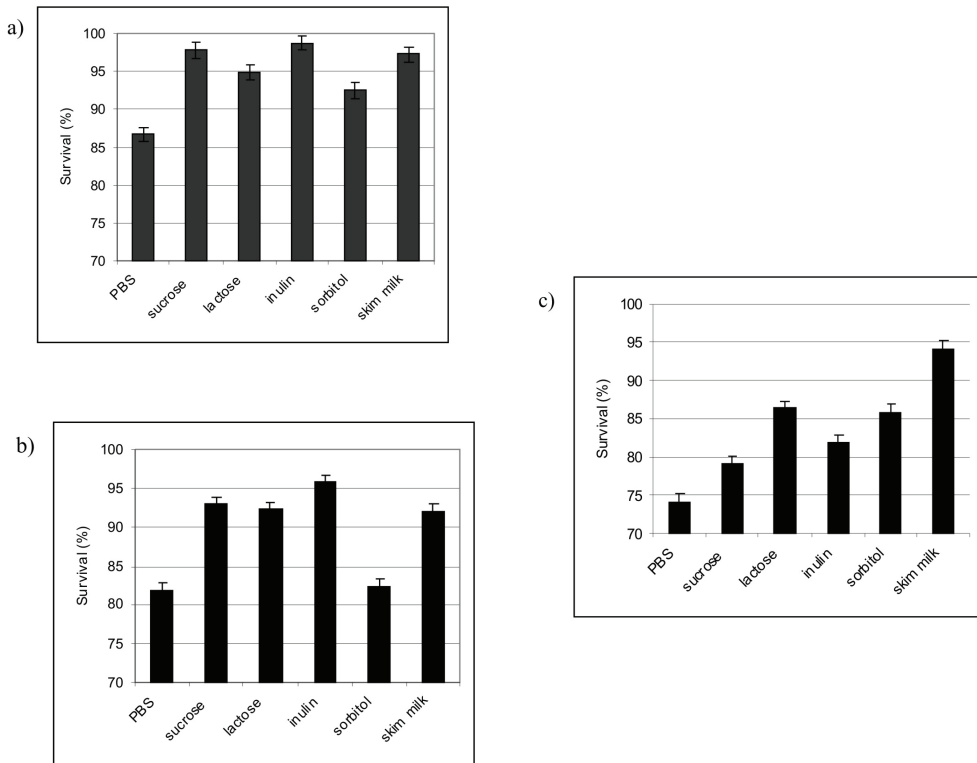

Fig. 1. Survival (%) of probiotic strains a) *L. helveticus* M92, b) *L. plantarum* L4 and c) *E. faecium* L3 after freeze-drying with various lyoprotectors

Table 1. Viability of probiotic strains after freeze-drying in the skim milk during 12 months storage at 4 °C

Probiotic strains	Storage time (months)/ CFU/g				
	0	3	6	9	12
<i>L. helveticus</i> M92	2.51 x 10 ¹⁰	9.41 x 10 ⁹	8.84 x 10 ⁸	5.06 x 10 ⁸	1.06 x 10 ⁸
<i>L. plantarum</i> L4	1.87 x 10 ¹⁰	3.55 x 10 ⁹	2.96 x 10 ⁸	1.14 x 10 ⁸	7.36 x 10 ⁷
<i>E. faecium</i> L3	9.98 x 10 ¹⁰	3.24 x 10 ⁹	1.84 x 10 ⁸	4.35 x 10 ⁸	3.84 x 10 ⁷

Recently, microencapsulation technology raises great potential in delivery of probiotic as biotherapeutics and as functional starter cultures in the food biotechnology (Prakash and Urbanska, 2008). Microencapsulation of the live probiotic cells can be carried out with natural polymers to reduce cell losses during their biotechnological processing, storage and their application. Hence, the objective of this study was to determine the effects of the different matrices, polysaccharides alginate and κ-carrageenan on the cell viability during microencapsulation expressed as microencapsulation yield (EY). For food applications, cell entrapment in the food grade biopolymer gel matrices, κ-carrageenan and alginate, has been most widely used. As these biopolymers are of non-dairy origin and as such are not the best options for the incorporation in fermented dairy products, microencapsulation of probiotic cells in food grade, dairy protein casein was tested too. Each matrix-encapsulated probiotic strain was thereafter exposed to the rigorous simulated GIT conditions to determine the protective role of microencapsulation on the cell viability. Table 2 shows the encapsulation yields (EY) for the probiotic strains microencapsulated in these three matrices.

Table 2. Microencapsulation yield determined after the microencapsulation of the probiotic cells *L. helveticus* M92, *L. plantarum* L4 and *E. faecium* L3 in different matrices

Probiotic strain	Microencapsulation yield in different matrices (%)		
	Alginate	Caseinate	κ -carrageenan
<i>L. helveticus</i> M92	97.0 ± 1.5	93.3 ± 2.5	91.0 ± 2.8
<i>L. plantarum</i> L4	96.1 ± 1.8	91.9 ± 2.3	89.8 ± 4.3
<i>E. faecium</i> L3	91.5 ± 2.9	90.8 ± 3.1	88.1 ± 5.2

The morphology of the microencapsulated probiotic cells *L. helveticus* M92 in alginate was observed by microscopy (Fig. 3). The results indicate that the

microencapsulation methods lead to the higher viability for all of the strains compared to the viability of the cells in wet biomass in all of three different matrices tested in survive simulated GIT conditions. Survival of microencapsulated probiotic cells varied either with the strain and method of microencapsulation used, what was also demonstrated by other authors (Truelstrup Hansen et al., 2002; Guerin et al. 2003; Capela et al., 2006). It must be emphasized, that the cell viability after 5 h exposure in simulated GIT conditions was higher than 55 %, which considered more than 10^6 CFU/g what is in accordance with the claims set up for probiotic products (Fig. 2). A slight difference in the protective effect between *Lactobacillus* strains and *Enterococcus* was observed, despite the same microencapsulation method used, probably due to the different acid and bile salt resistance properties of the respective strains.

In general, microencapsulation using alginate was found to provide the greatest protection of bacteria against simulated GIT conditions, while microencapsulation of the *L. helveticus* M92 by means of transglutaminase (TGase)-induced gelation of caseinate was shown even more effective (Fig. 2). Similar improvements in survival obtained by microencapsulation in caseinate have been reported by Heidebach et al. (2009). It is possible that the improved survival of encapsulated cells can be partially explained by a higher pH within the protein matrix of the capsules, which protects the cells during incubation under low pH conditions. Hence, dairy proteins can offer substantive protection for the encapsulated cells, due to their pronounced buffering capacity.

A similar explanation for higher survival of encapsulated cells was found by Guerin et al. (2003), who encapsulated *Bifidobacterium bifidum* RO71 using Ca^{2+} -induced gelation of an alginate–pectin–whey-protein mixture. According to the Champagne and Fuister (2007), in addition to overcoming technological problems in the production of probiotics, cultures that are microencapsulated in alginate beads showed improved resilience to acid in the gastric environment and to bile salt solution. With gel particles, the cells are typically not released into the food products when added; *in vitro* and *ex vivo* studies showed that beads maintained their integrity in simulated gastric conditions, but subsequently released their content in the GI tract (Anal and Singh, 2007).

Concerning microencapsulation of probiotic cells in κ -carrageenan, the results have shown that the viability of the κ -carrageenan coated probiotic cells was something less effective compared to the viable cells counts obtained after the exposure of the cells microencapsulated in two other tested matrices (Fig. 2).

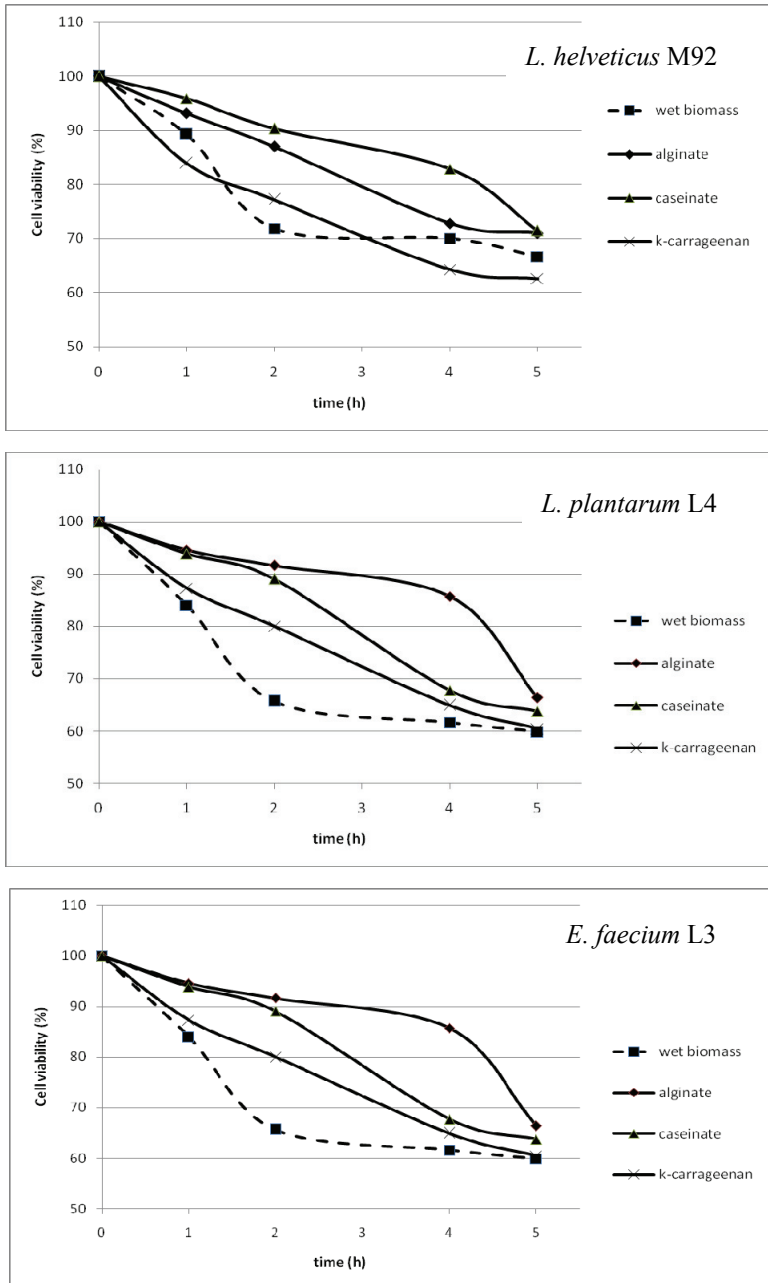

Fig. 2. Survival of *L. helveticus* M92, *L. plantarum* L4 and *E. faecium* L3 of wet biomass (free probiotic cells) (■) and microencapsulated cells in alginate (◆), in caseinate (▲) in κ -carrageenan (x) during exposure to simulated gastric juice (1 h) followed by exposure to simulated small intestinal juice (4 h)

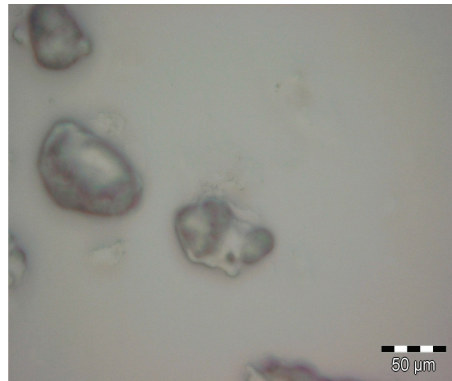

Fig. 3. Micrograph of alginate microcapsules containing *L. helveticus* M92 exposed to simulated gastrointestinal conditions (400 x magnification)

Furthermore, multiple-delivery methods were investigated, combination of freeze-drying of the probiotic cells followed by the microencapsulation of the active freeze-dried probiotic cultures and microencapsulation of the probiotic cells in alginate followed by freeze-drying of obtained microcapsules, while microencapsulation of the wet probiotic cell biomass was used for the comparison (Table 3). To summarise the results of the present work it could be recommended that for higher probiotic cell delivery in intestine freeze-dried probiotic cells for functional food production must be microencapsulated in appropriate matrix. The results of the present study could be the basis for more efficacious and diverse probiotic products development in the future, leading to improved consumer health.

Table 3. Viable cell counts of probiotic cells observed after microencapsulation in alginate (ME), freeze-drying in skim milk followed by microencapsulation in alginate (FD+ME), and microencapsulation in alginate followed by freeze-drying (ME+.FD)

Method	<i>L. helveticus</i> M92			<i>L. plantarum</i> L4			<i>E. faecium</i> L3		
	N ₀	N	Viability (%)	N ₀	N	Viability (%)	N ₀	N	Viability (%)
ME	11.1	10.8	97.0	11.1	10.6	96.0	10.3	9.4	91.5
ME+FD	10.4	8.6	83.1	10.6	8.5	79.6	10.3	7.2	69.1
FD+ME	10.9	9.9	91.1	9.8	7.9	80.6	9.8	7.9	80.6

N - viable cell count in the final cell preparation

N₀ - viable cell count in the wet biomass

Conclusions

One of the most important functional properties of probiotic cultures is their ability to survive GIT transit in the adequate numbers to elicit probiotic effects. Hence, the efficient oral delivery of probiotic cultures to the host represents a major challenge in probiotic product development. Considering freeze-drying, microencapsulation and viability during preparation, storage, and survival in simulated GIT conditions, freeze-drying with skim milk as lyoprotector, all three introduced microencapsulation techniques improved the viable cell count of *L. helveticus* M92, *L. plantarum* L4 and *E. faecium* L3 prepared as biotherapeutics.

References

- Anal, A.K., Singh, H. (2007): Recent advances in microencapsulation of probiotics for industrial applications and targeted delivery, *Trends Food Sci. Technol.* 18 (5), 240–251.
- Beganović J (2008): Application of proteomics and other molecular methods in the characterisation of the functionality of the probiotic bacteria. Ph.D. Thesis, University of Zagreb, Croatia.
- Champagne, C.P., Fustier, P. (2007): Microencapsulation for the improved delivery of bioactive compounds into foods, *Curr. Opin. Biotechnol.* 18 (2), 184–190.
- Capela, P., Hay, T.K.C., Shah, N.P. (2006): Effect of cryoprotectants, prebiotics and microincapsulation of probiotic organisms in yoghurt and freeze-dried yoghurt, *Food Res. Int.* 39, 203–211.
- Carvalho, A. S., Silva, J., Ho, P., Teixeira, P., Malcata, F. X., Gibbs, P. (2004): Relevant factors for the preparation of freeze-dried lactic acid bacteria, *Int. Dairy J.* 14, 835–847.
- Chandramouli, V., Kailasapathy, K., Peiris, P., Jones, M., (2004): An improved method of microencapsulation and its evaluation to protect *Lactobacillus* spp. in simulated gastric conditions, *J. Microbiol. Methods* 56(1), 27-35.
- Conway, P.L., Gorbach, S.L., Goldin, B.R., (1987): Survival of lactic acid bacteria in the human stomach and adhesion to intestinal cells, *J. Dairy Sci.* 70, 1-12.
- De Giulio, B., Orlando, P., Barba, G., Coppola, R., De Rosa, M., Sada, A., De Prisco, P.P., Nazzaro, F. (2005): Use of alginate and cryo-protective sugars to improve the viability of lactic acid bacteria after freezing and freeze-drying, *World J. Microbiol. Biotechnol.* 21 (5), 739–746.
- FAO/WHO (2001): Evaluation of health and nutritional properties of powder milk with live lactic acid bacteria: Report from FAO/WHO expert consultation (pp. 1–4).
- Frece, J., Kos, B., Beganović, J., Vuković, S., Šušković, J. (2005) *In vivo* testing of functional properties of three selected probiotic strains, *World J. Microbiol. Biotechnol.* 21, 1401-1408.
- Gardiner, G.E., O’Sullivan, E., Kelly, J., Auty, M.A.E., Fitzgerald, G.F., Collins, J.K., Ross, R.P., and Stanton, C. (2000): Comparative survival rates of human-derived probiotic *Lactobacillus paracasei* and *L. salivarius* strains during heat treatment and spray drying, *Appl. Environ. Microbiol.* 66, 2605-2612.

- Gilliland, S.E., Morelli, L., Reid, G. (2001): Health and nutritional properties of probiotics in food including powder milk with live lactic acid bacteria. Paper presented at the Joint FAO/WHO expert consultation on evaluation of health and nutritional properties of probiotics in food including powder milk with live lactic acid bacteria, Cordoba, Argentina.
- Guarner, F. and Schaafsma, G.J. (1998): Probiotics, *Int. J. Food Microbiol.* 39, 237-238.
- Guerin, D., Vuilleumard, J.C., Subirade, M., (2003): Protection of bifidobacteria encapsulated in polysaccharide-protein gel beads against gastric juice and bile, *J. Food Protect.* 66, 2076–2084.
- Heidebach, T., Forst, P., Kulozik, U. (2009): Transglutaminase-induced caseinate gelation for the microencapsulation of probiotic cells, *Int. Dairy J.* 19, 77-84.
- Kos, B., Šušković, J., Goreta, J., Matošić, S. (2000): Effect of protectors on the viability of *Lactobacillus acidophilus* M92 in simulated gastrointestinal conditions, *Food Technol. Biotechnol.* 38, 121–128.
- Kos, B. (2001): Probiotic Concept: *In Vitro* Investigations with Chosen Lactic Acid Bacteria, PhD Thesis, Faculty of Food Technology and Biotechnology, University of Zagreb, Croatia.
- Kos, B., Šušković, J., Vuković, S., Šimpraga, M., Frece, J., Matošić, S. (2003): Adhesion and aggregation ability of probiotic strain *Lactobacillus acidophilus* M92, *J. Appl. Microbiol.* 94, 981-987.
- Kos, B., Šušković, J., Beganović, J., Gjuračić, K., Frece, J., Iannaccone, C., Canganella, F. (2008): Characterization of the three selected probiotic strains for the application in food industry, *World J. Microbiol. Biotechnol.* 24, 699-707.
- Leboš Pavunc, A., Beganović, J., Kos, B., Buneta, A., Beluhan, S., Šušković, J. (2010): Influence of microencapsulation and transglutaminase on viability of probiotic strain *Lactobacillus helveticus* M92 and consistency of set yoghurt, *Int. J. Dairy Technol.* DOI: 10.1111/j.1471-0307.2010.00647.x
- Ouweland, A.C., Suomalainen, T., Tolkkio, S., Salminen, S. (2002): *In vitro* adhesion of propionic acid bacteria to human intestinal mucus, *Lait* 82, 123-130.
- Ozer, B., Kirmaci, H.A., Senel, E., Atamer, A., Hayaloglu, A. (2009): Improving the viability of *Bifidobacterium bifidum* BB-12 and *Lactobacillus acidophilus* LA-5 in white-brined cheese by microencapsulation, *Int. Dairy J.* 19, 22-29.
- Otero, M.C., Espeche, M. C., Nader-Macias, M.E. (2007): Optimization of the freeze-drying media and survival throughout storage of freeze-dried *Lactobacillus gasseri* and *Lactobacillus delbrueckii* subsp. *delbrueckii* for veterinarian probiotic applications, *Process Biochem.* 42, 1406-1411.
- Prasad, J., McJarrow, P., Gopal, P. (2003): Heat and Osmotic Stress Responses of Probiotic *Lactobacillus rhamnosus* HN001 (DR20) in Relation to Viability after Drying, *Appl. Environ. Microbiol.* 69(2), 917-925.
- Prakash and Urbanska, (2008): Colon target delivery of live bacterial cell biotherapeutics including microencapsulated live bacterial cells, *Biologics: Targets Ther.* 2(3), 355-378.
- Pekkonen, K.S, Roos, Y.H., Miao, S., Ross, R.P., Stanton C. (2008): State transitions and physicochemical aspects of cryoprotection and stabilization in freeze-drying of *Lactobacillus rhamnosus* GG (LGG), *J. Appl. Microbiol.* 104, 1732-1743.
- Shah, N.P. (2000): Probiotic bacteria: selective enumeration and survival in dairy foods, *J. Dairy Sci.* 83, 894-907.

Topic: Food technology and biotechnology

- Šušković, J. (1996): The growth and probiotic effect of chosen lactic acid bacteria. Ph.D. Thesis, Faculty of Food Technology and Biotechnology, University of Zagreb, Croatia.
- Šušković, J., Kos, B., Matošić, S., Besendorfer, V. (2000): The effect of bile salts on survival and morphology of potential probiotic strain *Lactobacillus acidophilus* M92, *World J. Microbiol. Biotechnol.* 16, 673-678.
- Šušković, J., Kos, B., Goreta, J., Matošić S. (2001): Role of lactic acid bacteria and bifidobacteria in synbiotic effect, *Food Technol. Biotechnol.* 39, 227-235.
- Šušković, J., Kos, B., Beganović, J., Leboš Pavunc, A., Habjanič, K., Matošić, S. (2010): Antimicrobial Activity – The Most Important Property of Probiotic and Starter Lactic Acid Bacteria, *Food Technol. Biotechnol.* 48 (3) 296-307.
- Truelstrup Hansen, L., Allan-Wojtas, P.M., Jin, Y.L., Paulson, A.T. (2002): Survival of free and Ca-alginate microencapsulated *Bifidobacterium* spp. in simulated gastrointestinal conditions, *Food Microbiol.* 19, 35-45.

Characterization of flow properties of different flour types and mixtures used in bread making

UDC: 664.746

M. Benković, I. Bauman*

University of Zagreb, Faculty of Food Technology and Biotechnology, Pierottijeva 6, 10000 Zagreb, Croatia

Summary

In order to avoid major problems in cereal handling and processing industry, it is necessary to determine flour flow properties. Although flour and starch powders under normal storage conditions exhibit relatively good flowability, there are certain differences between various types of flours used in bread making industry. This research presents a characterization and comparison of cohesion index, powder flow speed dependency and caking properties of different flour types and flour mixtures used in bread making. Stable Micro Systems TA.HDPlus Powder Flow Analyzer was used to determine flow properties of flours and flour mixtures. Wheat flour particles are heterogeneous and anisotropic. They have been considered as relatively free flowing, poorly cohesive powders, which do not cause caking problems (Peleg et al., 1973). However, whole meal wheat flour used in this research is categorized as extremely cohesive (cohesion index = 17.61) and wheat flour as very cohesive (cohesion index in the range 14-16). Based on powder flow speed dependency test, flours and flour mixtures do not show dependence on flow speed. Whole meal wheat flour is more susceptible to caking than other flour samples. Flour mixtures flow properties depend on the percentage of flour types added to the mixture. White wheat flour, whole meal wheat flour and corn flour exhibit different flow properties in dependence on their particle size and chemical composition. Mixture characteristics depend on the percentage of flour types added to the mixture.

Keywords: flour, flow properties, mixtures

Introduction

Bread is one of the most widely spread foods in the world. Its production includes different unit operations such as milling and sieving the flour, mixing different types of flour, mixing the flour with water and all other constituents into a very viscous mixture – dough, proofing and baking. The conditions used for these operations and the constituents of the mixtures represent an important factor in handling and processing bread. Mixing of flour is one of the first steps of bread making and the quality as well as the composition of the mixtures significantly effects the quality of the end product (Emami and Tabil, 2008; Fustier et al., 2008). Therefore, it is crucial to know how the mixtures act during and after the mixing process and weather the

*ibauman@pbf.hr

mixture has undergone changes during the mixing and transportation process. According to Peleg et al., wheat flour particles are heterogenic and anisotropic, and the flour is characterized as relatively free flowing, poorly cohesive and not susceptible to caking (Peleg et al., 1973). However, flour mixtures represent a different case of flow properties, since particles of different sizes and properties are put together to form a homogeneous mixture. In such mixtures, particle – particle interactions differ from the ones used in plain flour. For example, smaller particles can adhere on the surface of the larger ones and thus form a new particle with new characteristics. Beside the difference in size, the percentage of flour types added to the mixture also plays an important role in mixing, powder flow properties determination, dough rheology and the quality of end product (Zaidul et al., 2007; Bauman et al., 2007). In this research, ten flour mixtures used in bread making were made according to Croatian regulations, for manufacturing: white flour bread, whole meal wheat flour bread, corn bread and rye bread, mixed whole meal/white flour bread, mixed corn/white flour bread and mixed rye/white flour bread. The objective of this work was to determine in which way different percentages of white flour added to the mixtures effect powder properties and to predict the behavior of these mixtures in production environment based on their flow properties.

Materials and methods

Materials

Following flour types were used to make the mixtures: white wheat flour, finely ground (Podravka, Koprivnica, Croatia), whole meal wheat flour (Čakovečki mlinovi, Čakovec, Croatia), corn flour (Čakovečki mlinovi, Čakovec, Croatia) and rye flour type 1250 (Čakovečki mlinovi, Čakovec, Croatia). The mixtures were prepared according to the Croatian regulations for bread and wheat products (Pravilnik o žitaricama, mlinarskim i pekarskim proizvodima, tjestenini, tijestu i proizvodima od tijesta NN 78/2005), as shown in Table 1. Approximately 500 g of the sample was mixed in Turbula mixer (Willy A. Bachofen Maschienenfabrik, Muttenz, Switzerland) for 10 minutes to obtain a homogenous blend of flours.

Table 1. Experimental formulations of the flour mixtures

Sample name	Composition [% w/w]
GB	100% wheat flour
IB	100% whole meal wheat flour
IK	80% whole meal wheat flour + 20% wheat flour
IM	20% whole meal wheat flour + 80% wheat flour
KB	100% corn flour
KK	60% corn flour + 40% wheat flour
KM	20% corn flour + 80% wheat flour
RB	100% rye flour
RK	70% rye flour + 30% wheat flour
RM	30% rye flour + 70% wheat flour

Particle size measurement

Particle size of the samples was determined based on laser beam diffraction pattern of particles using the Mastersizer 2000 (Malvern Instruments, Worcestershire, UK). Dry feeding methods were used to subject the sample to the laser beam using Scirocco 2000 dry dispersion unit (Malvern Instruments, Worcestershire, UK). The Mastersizer was connected to a PC equipped with Malvern software (Malvern Instruments, Worcestershire, UK). Five measurements were conducted and an average value and standard deviation was calculated.

Cohesion properties

Cohesion properties were evaluated by performing the “Quick test” using TA.HDPlus Texture Analyser coupled with Powder Flow Analyser (Stable Micro Systems, Godalming, UK). Prior to testing, the flour mixture was poured into a glass cylinder up to approximately 160 mL volume, weighed and put on to the Powder Flow Analyser base. The test begins with 2 conditioning cycles used to remove any physical stress from the powder and to homogenize the sample. Three measurements are conducted with the blade moving up and down through the powder column. Results are shown as a force/distance graph (Fig. 1) and the surface under the negative part of the curve (obtained when the blade moves downwards through the powder column) is used to calculate the cohesion coefficient.

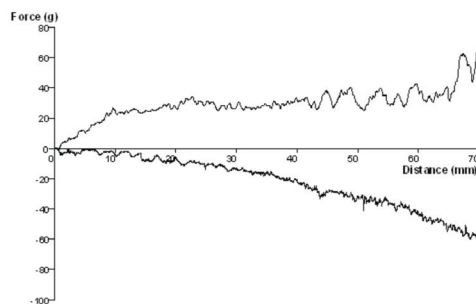

Fig. 1. Example of the force/distance curve obtained by the quick test

By dividing the cohesion coefficient with the mass of the sample, the cohesion index values are obtained, by which the powders are categorized in groups as shown in Table 2.

Table 2. Categorization of powders based on cohesion indeks

Cohesion Index	Flow behaviour
19+	Hardened, extremely cohesive
16-19	Very cohesive
14-16	Cohesive
11-14	Easy flowing
11	Free flowing

Caking properties

Caking test was also performed using TA.HDPlus Texture Analyser coupled with Powder Flow Analyser (Stable Micro Systems, Surrey, United Kingdom). The test begins with two conditioning cycles. The blade levels the top of the powder column and measures the height of the column, after which it moves down through the column at a tip speed of 20 mm/s and compacts the powder to a pre-defined force (75 N). When the blade reaches required force it slices up through the powder at 10 mm/s and repeats the compaction cycle four more times. The results are shown in force/distance graph shown in Fig. 2.

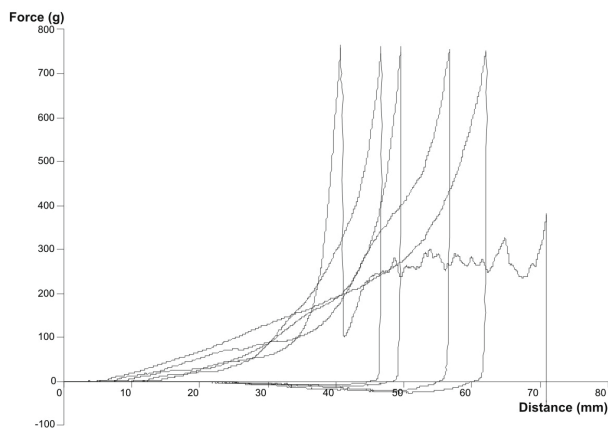

Fig. 2. Example of the force/distance curve obtained by caking test

At the beginning of every cycle the blade measures the height of the column and the height of the powder cake are recorded when the target force is reached. The column height ratio (current cycle column height divided by initial column height) and the cake height ratio (current cycle cake height divided by initial column height) are recorded to give information about the settlement and compaction of the powder column.

Powder flow speed dependency

Powder Flow Speed Dependency test (PFSD) gives important information about the speed flow properties of a powder and this can be of interest in a production environment. PFSD test was performed using TA.HDPlus Powder Flow Analyser (Stable Micro Systems, Surrey, United Kingdom). The test starts with two conditioning cycles which are followed by cycles run at a tip speed of 10 mm/s, 20mm/s, 50 mm/s, 100 mm/s and two final cycles at 10 mm/s. The area under the positive part of the curve (Fig. 3), which is the work of compaction, was calculated using Texture Exponent 32 software (Stable Micro Systems, Surrey, United Kingdom).

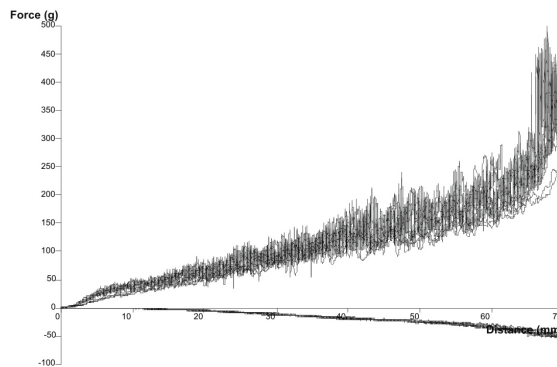

Fig. 3. Example of the force/distance curve obtained by PFSD test

Results and discussion

Particle size

Particle size distributions for the analysed samples are shown in Fig. 4. All the flour types were analysed before they were mixed together and particle size analysis was also conducted for the mixtures, after mixing the flours in the Turbula mixer. Therefore, Fig. 4 comprises of three parts, a) for whole meal and wheat flours and mixtures, b) for corn and wheat flours and mixtures and c) for rye and wheat flour and mixtures. It is visible from Fig. 4 that the peak value representing particle size for the mixtures migrates depending on the percentage of wheat flour added to the mixture and whether the mixture is used for making pure or mixed bread type. Values on the y axes represent the volume percentage of the flour type in the mixture, and this value also differs depending on the mixtures composition. Based on these measurements of different flour mixtures one can notice that laser diffraction particle size analysis could be used to determine the physical composition of the mixtures containing various powder types.

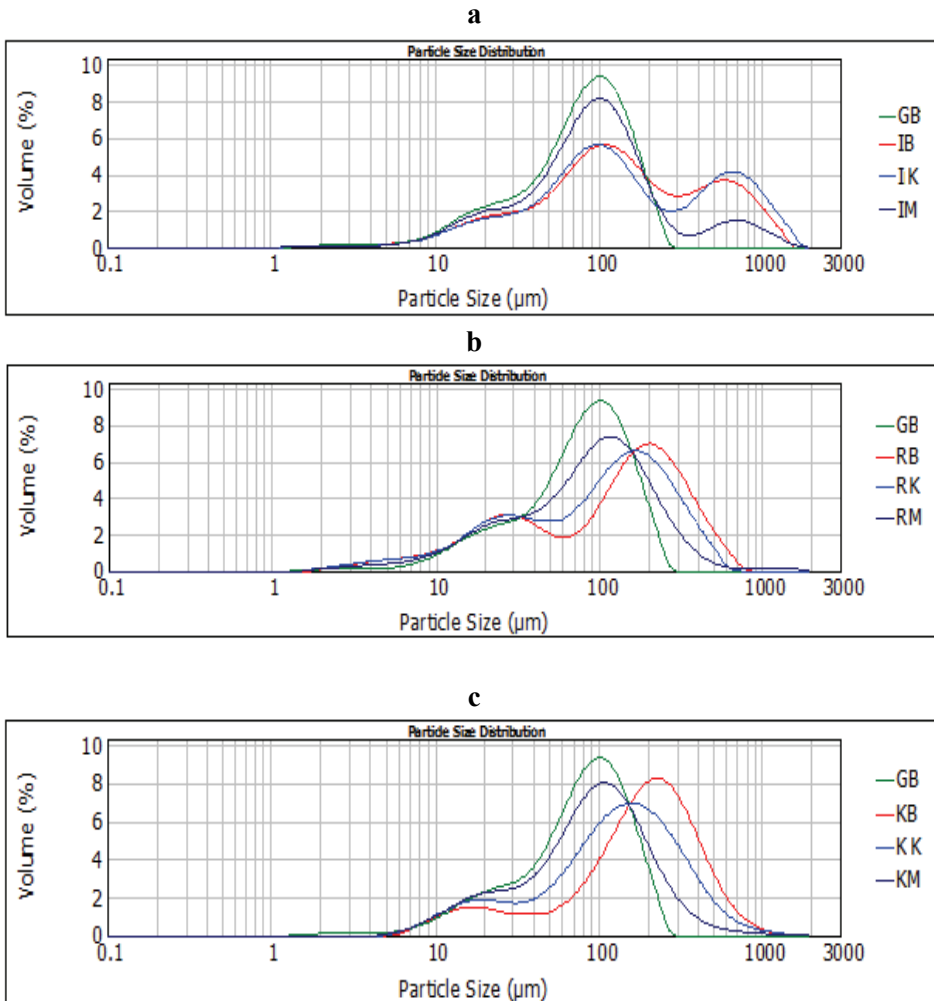

Fig. 4. Particle size distributions of flours and flour mixtures
a) whole meal, b) rye, c) corn

Cohesion properties

Cohesion properties were evaluated by performing a “Quick Test”. The powders were categorized according to cohesion coefficient values as follows: samples that contain wheat and whole meal wheat flour in surplus are very cohesive, but not extremely cohesive like the ones that contain corn or whey flour with a larger amount of bigger particles, as can be seen in Fig. 4.

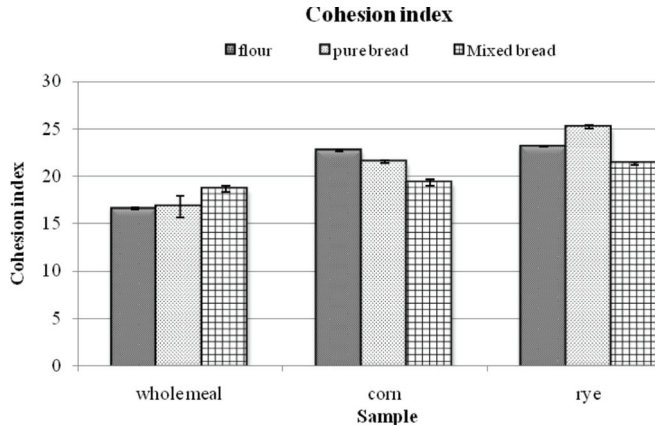

Fig. 5. Cohesion index values of flours and flour mixtures

According to the quick test results shown in Fig. 5, whole meal wheat flour and its mixtures exhibit the lowest cohesion index values. The rationale behind this observation lies in the high percentage of bran – particles with big diameters. Rye flour and rye flour mixtures show the highest cohesion index, with an exception of mixed rye bread, where the high percentage of wheat flour lowers the cohesion index. The same observation can be made with corn bread – high percentage of wheat flour lowers the cohesion index.

Caking properties

Caking test was performed to show a dependence of the cake height ratio towards the cycle number performed during testing. Results are shown in Fig. 6. All the mixtures exhibit increasing cake height ratios, indicating that they are all susceptible to caking, as can be seen in Fig. 6.

The lowest values of cake height ratio can be seen for mixed breads, where the high percentage of white wheat flour causes a change in caking properties by lowering the height of the cake in the Powder Flow Analyser column. According to these results, white wheat flour appears to be acting like an anti caking agent, making the mixtures used for baking of mixed bread types less susceptible to caking by forming a weak cake, which can easily be broken. This does not appear to be as effective with pure bread types, indicating that the lower percentage of white whole meal flour added is not sufficient to prevent clumping or to act like an anti caking agent. Therefore, it appears that white wheat flour can be used to prevent or at least diminish caking in these mixtures, but its efficiency depends on the amount of white wheat flour added to the mixture (different component ratio).

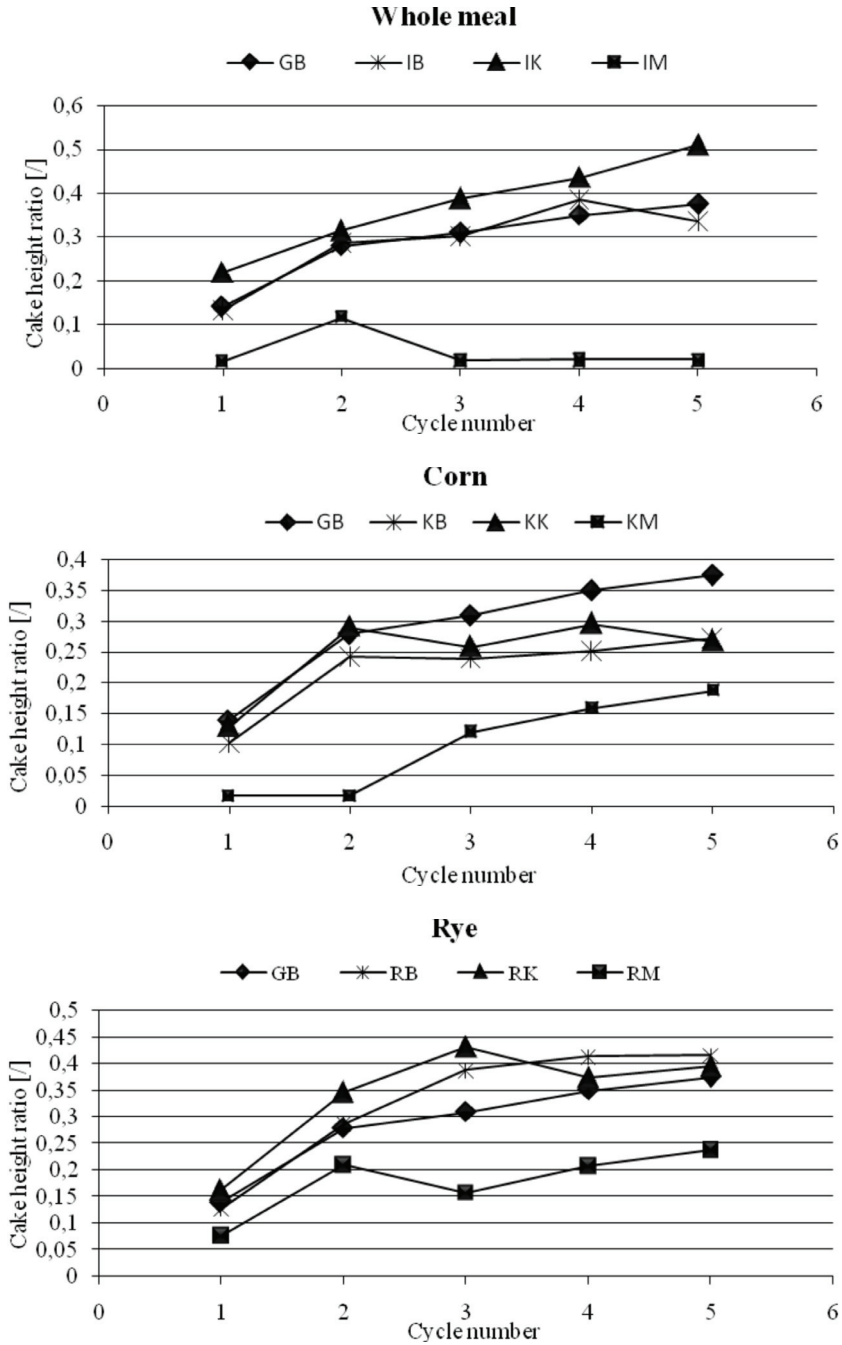

Fig. 6. Caking profiles of the flours and flour mixtures

Powder flow speed dependency

Dependence of the physical properties of flours and mixtures towards the speed with which they flow was determined as a dependence of compaction coefficient towards the tip speed with which the blade moves through the powder column. Results are shown in Fig. 7.

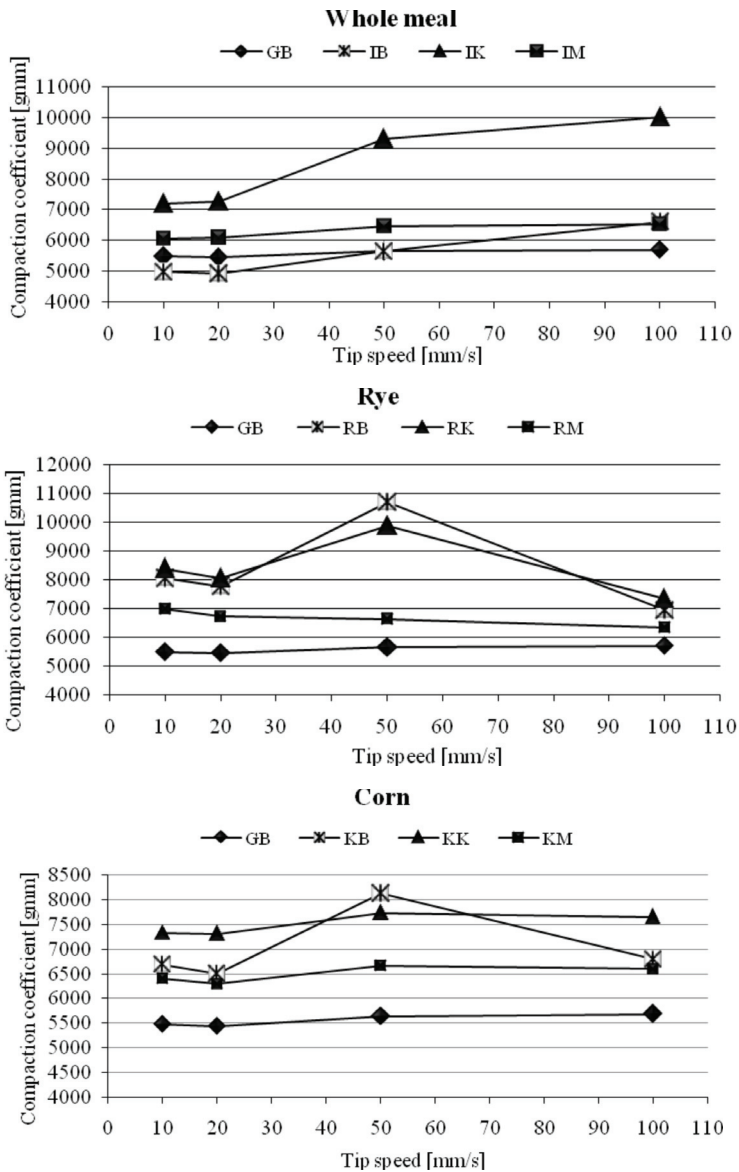

Fig. 7. PFSD profiles of flours and flour mixtures

Most of the mixtures, with an exception of IK, KB, RB and RK show constant compaction coefficient values, which indicates they are flow speed independent. White wheat flour shows the lowest compaction coefficient values.

As for whole meal breads, exception can be seen for sample IK (80 % whole meal flour and 20 % of white wheat flour), which shows the highest compaction coefficient values and a slight rise in the compaction coefficient with increasing blade speed. This indicates a slight flow speed dependency. Pure corn flour (sample KB) exhibits a rise in compaction coefficient value at the tip speed 50 mm/s (Fig. 7) which indicates some changes in the powder structure that could be due to attrition or particle breakdown. The same observation is noticed for samples RB and RK.

Conclusions

Considering the fact that powder flowability represents an important step in industry and processing, especially in bread making where tones of flour are mixed and conveyed through the facility daily, the purpose of this research was to show how different flour types and flour mixtures that are most commonly used in bread making act when subjected to mixing procedures and transport. The objective of this work was to determine in which way different percentages of white flour added to the mixtures effect powder properties and to predict the behaviour of these mixtures in production environment based on their flow properties.

Based on the research results following conclusions can be made:

- Laser diffraction particle size analysis can be used to determine the physical composition of the mixtures containing various types of powders;
- According to the cohesion index, the mixtures are classified as very or extremely cohesive;
- All the mixtures are susceptible to caking;
- Most of the samples exhibit unchanging or compaction coefficients, which indicates they are flow speed independent;
- Flow properties of the mixtures depend on the percentage and type of flour added to the mixture, as well as their particle size.

References

- Bauman, I., Ćurić, D., Boban, M., Muminović, Š. (2007): Impact of physical properties on mixture homogeneity and bread quality. In: 4th International Congress Flour – Bread, Ugarčić – Hardi, Ž. (ed.), Osijek, 431–437.
- Emami, S., Tabil, L.G. (2008): Friction and compression characteristics of chickpea flour and components, *Pow. Technol.* 182, 119–126.
- Fustier, P., Castaigne, F., Turgeon, S.L., Biliaderis, C.G. (2008): Flour constituent interactions and their influence on dough rheology of semi-sweet biscuits: A mixture design approach with reconstituted blends of gluten, water – soluble and starch fractions, *J. Cereal Sci.* 48, 144–158.
- Peleg, M., Mennheim, C.H., Passy, N. (1973): Flow properties of some food powders. *J. Food Sci.* 38, 959–964.
- Pravilnik o žitaricama, mlinarskim i pekarskim proizvodima, tjestenini, tijestu i proizvodima od tijesta NN 78/2005.
- Zaidul, I.S.M., Nik Norulaini, N.A., Mohd Omar, A.K., Yamauchi, H., Noda, T. (2007): RVA analysis of mixtures of wheat flour and potato, sweet potato, yam, and cassava starches. *Carbohydr. Polim.* 69, 784–791.

Determination of metals in olive oil by electrothermal atomic absorption spectrometry

UDC: 665.327.3 : 543.4

M. Brkljača^{1*}, J. Giljanović²

¹*Institute for Adriatic Crops and Karst Reclamation – Split, Put Duilova 11, 21000 Split, Croatia*

²*University of Split, Faculty of Chemistry and Technology, Teslina 10/V, 21000 Split, Croatia*

Summary

The aim of this work is to propose the most efficient procedure for preparation of olive oil samples for analysis of copper, cadmium, nickel, lead and iron by electrothermal atomic absorption spectrometry, and to assess metal content in Croatian virgin olive oils. Digestion with HNO₃, H₂SO₄ and H₂O₂ assisted by microwave energy in open glass test tubes was not efficient for copper, cadmium, nickel and lead determination, except for iron determination for which precision was low. Extraction of metals with HNO₃, $c = 1.5 \text{ mol L}^{-1}$, was precise but not complete. The most suitable procedure was heating of samples at 300 °C for 24 hours and dry ashing in muffle furnace at 450 °C for 16 hours. The latter method was applied for analyses of metals in samples collected from local family growers of Dalmatia. The content of Cu, Pb and Fe was higher ($P < 0.05$) in oils extracted by press than by centrifugation. The samples were classified by cluster analysis into three groups. We identified only one group of samples representing one region. Probably their metal composition was more influenced by the environmental conditions than the type of extraction. Therefore the metal content could be used for identification of regional origin. The metal contents were below the maximum allowed levels (OG 16/05), and were in close agreement with data reported for Spanish and Italian olive oils.

Keywords: ET-AAS, metal, olive oil, sample preparation

Introduction

In Croatia olive is the third most widespread fruit tree that is grown in narrow coastal regions of Istria, Kvarner, Dalmatia and on islands. The production of (1.5-5) thousand tons of olive oil per year equals to (0.5-2) % of the world production. More than 90 % of Croatian olive oil is produced on small family farms. Recently, the number of new trees in Croatia grows rapidly. The percent of the Croatian trees younger than 10 years increased from about 4 % in 1980s to about 18 % in 2000s. The increase in the production was due to the recognition

* mbrkljaca@unizd.hr

of olive oil's positive effect on health of blood vessels, digestion system, skin, endocrinal system and bones, as well as retarding the aging process (Viola, 1997). In olive oil production the most important task is to slow the oxidation process and protect the oil from the contamination. The metals are important contaminant entering in oil from soil, herbicides or pesticides, fertilizers, and metal parts during olives processing and storage. In order to produce high quality oil the metal content has to be monitored continuously. For most analytical techniques olive oil matrix should be destroyed completely. High organic content and very low content of metals (mostly lower than 50 ng g^{-1}) makes the sample preparation the critical step in the analysis.

The aim of this paper is to find the most adequate procedure for the preparation of the olive oil samples for copper, cadmium, nickel, lead and iron determination by electrothermal atomic absorption spectrometry (ET-AAS) and to determine the content of these metals in olive oils collected on family farms in Dalmatia.

Materials and Methods

Sample collection: The samples were collected from small olive growers of north and middle Dalmatia region. Sampling was performed in olive mills immediately after processing placing the oil samples in equal 1-L glass bottles sealed with polyethylene cups. The samples were kept until measurement in dark at room temperature.

Dry ashing procedure: Olive oil was dried on hot plate by gradually increasing temperature up to maximal temperature of $300 \text{ }^{\circ}\text{C}$ for 48 hours, then placed in cold muffle furnace (Elektrosanitarij) gradually increasing temperature by $1 \text{ }^{\circ}\text{C min}^{-1}$ to $450 \text{ }^{\circ}\text{C}$ and continued for 16 hours at $450 \text{ }^{\circ}\text{C}$. After cooling 5 mL of 6 mol L^{-1} HCl was added and dried on hot plate. The residue was dissolved in 5 g of 0.1 mol L^{-1} HNO_3 .

Wet ashing procedure: 2 g of oil was weighted in Pyrex tubes, added 20 mL of HNO_3 and 10 mL of H_2SO_4 and left to stand for two hours. Then the tubes were placed on Star 2, CEM for the digestion assisted by microwaves with addition of HNO_3 and H_2O_2 (Varian, 1996). The clear and colorless solution was evaporated to 1 mL on hot plate and dissolved to 20 g in 0.1 mol L^{-1} HNO_3 .

Extraction procedure: 3 g of oil was weighted in 15-mL tubes of polyethylene and 1 g of HNO_3 , $c = 1.5 \text{ mol L}^{-1}$ was added. The tubes were sealed and placed on water bath at $90 \text{ }^{\circ}\text{C}$ for 1 hour. Then the tubes were placed on reciprocating shaker (Central Scientific USA) at 180 rpm for 20 hours. After standing for 4 hours the lower water layer was taken for metals determination. The measurements were performed by atomic absorption spectrometer SpectrAA 220 with graphite furnace GTA-110, all Varian. Deuterium lamp was used for background correction and argon was inert gas.

Measurement: The standard solutions of Cu, Cd, Ni, Pb and Fe were made by diluting the stock solutions of $\text{Cu}(\text{NO}_3)_2$, $\text{Cd}(\text{NO}_3)_2$, $\text{Pb}(\text{NO}_3)_2$ and $\text{Fe}(\text{NO}_3)_3$,

$\gamma = 1.000 \text{ g L}^{-1}$, all CeriPUR, Merck, and $\text{Ni}(\text{NO}_3)_2$, $\gamma = 1.000 \text{ g L}^{-1}$, grade for spectroscopy, Fluka. The standard solutions were diluted in polyethylene tubes in $0.1 \text{ mol L}^{-1} \text{ HNO}_3$. The solutions: $\text{Pd}(\text{NO}_3)_2$, $\gamma = (10.0 \pm 0.2) \text{ g L}^{-1}$, $\text{Mg}(\text{NO}_3)_2$, $\gamma = (10.0 \pm 0.2) \text{ g L}^{-1}$ and $\text{NH}_4\text{H}_2\text{PO}_4$ were used for matrix modification, and HNO_3 , Suprapur, HCl, Suprapur, H_2O_2 , medical pure and H_2SO_4 , p.a., all Merck, were also used. Ultra clean water was used for preparation of all solutions.

Washing laboratory dishes: dishes were soaked in 2 % laboratory detergent (Kemex A, Kemika), and thoroughly washed in tap and ultra clean water. The dishes were kept at least six days in HNO_3 ($\text{HNO}_3/\text{water}$ 1/10). Before use the dishes were rinsed in ultra clean water. Quartz dishes used for dry ashing were soaked in hot HCl, HCl/ H_2O 1/1 and rinsed in ultra clean water.

Results and Discussion

Comparison of procedures for sample preparation and metals determination by ET-AAS in olive oil

Olive oil was prepared by dry ashing, wet ashing and extraction with HNO_3 , each procedure in five replicates. The results were presented in Table 1. The preparation of olive oil by wet ashing was not suitable for the determination of Cu, Cd, Ni and Pb since its sensitivities were low. The content of Fe and corresponding RSD were higher after wet ashing than after the dry ashing procedure, which could be due to contamination of sample solution by reagents and during their elimination by evaporation.

Table 1. Results of determination of olive oil after preparation of samples by dry ashing, wet ashing assisted by microwaves and extraction with HNO_3

Method	Content / ng g^{-1} (RSD / %)				
	Cu	Cd	Ni	Pb	Fe
Dry ashing ^a	10.2 (27)	0.26 (65)	1.0 (50)	4.4 (30)	626 (12)
Extraction with HNO_3 ^a	2.2 (18)	-	-	0.47 (34)	490 (13)
Wet ashing ^b	-	-	-	-	1347 (94)

^a Arithmetic mean of 5 parallel measurements

^b Arithmetic mean of 5 parallel measurements

-Not detected

The content of Cu, Pb and Fe measured after extraction with HNO_3 was 22 %, 16 % and 78 %, respectively, of the same amount measured after dry ashing. The recoveries were lower than recoveries of Cu, Fe and Ni being 54 %, 65 % and

77.4 % measured after the extraction using 10 % HNO₃ (De Leonardis et al., 2000). The content of Cd and Ni could not be detected by HNO₃ extraction procedure. Among three procedures only dry ashing allowed the determination of all five metals and therefore was selected for all subsequent analysis.

Validation of method for determination of metals in olive oil by ET-AAS after dry ashing

For each analyte the calibration curve was constructed for means of measurement by external standard solutions method of Cu, Cd, Ni, Pb and Fe and by the method of standard additions. Except for Pb, calibration slope of the method of standard addition were different from the method of external standard solutions. That was ascribed to the effect of sample matrix and therefore the method of standard additions was used for all subsequent calibrations.

The following chemicals were tested for the use as matrix modifiers: Pd(NO₃)₂, Mg(NO₃)₂, NH₄H₂PO₄ and NH₄PO₄+Mg(NO₃)₂. For Fe the highest signal was achieved with addition of Mg(NO₃)₂, but since the precision was low (RSD of 18.4 %), Pd(NO₃)₂ having satisfying precision and height of the signal was selected. For Cu and Ni the highest signal was achieved with Pd(NO₃)₂ and for Cd and Pb with NH₄H₂PO₄, which were selected as matrix modifiers.

The accuracy of the method for the determination of Cu and Fe was assessed by the analysis of the oil sample obtained from IOOC proficiency testing. Analytical recovery for Cu and Fe was (81±4) % and (94±18) %, respectively. The repeatability of the determination of Cu, Cd, Ni, Pb and Fe in olive oil was assessed by the analysis of authentic sample by the method of analyte addition in four parallel samples before the digestion. According to the literature data the range of relative standard deviation (RSD) of the determination of metals in olive oil was wide. RSD of Cu and Fe determined by ET-AAS after the dry ashing ranged from 1 % to 57 % (De Leonardis et al., 1997) for Cu was 8.43 % and for Fe was 0.85 % (Saleh et al., 1988) and for Cu, Fe and Ni were 32.9 %, 6.5 % and Ni 15.9 %, respectively (Ooms and Van Pee, 1983), while RSD of Cu, Fe, Ni and Pb using the method of direct determination was 23 %, 29 %, 22 % and 10 %, respectively (Perring and Basic-Dvorzak, 2002) and Cu, Fe and Ni was 150 %, 30 % and 30 % (Nash et al., 1983), respectively. Comparing to the available literature data the precision of the method proposed in this study was satisfactorily, except for the determination of nickel. The RSD of Cd determination using dry ashing and subsequent potentiometric determination was 4 % at the mass fraction of 5 ng g⁻¹ Cd (Lo Coco et al., 2003). In this study RSD for Cd was higher (19 %) but was achieved at 10 times lower mass fraction of Cd in oil of 0.5 ng g⁻¹.

The analytical recoveries calculated after the addition of analyte before the sample preparation and determined by AAS or potentiometry was (89-102) % (Lo Coco et al., 2003; Saleh et al., 1988), while using the ET-AAS it was as much

as (142–212) % (De Leonardis et al., 1997). The amount of added analyte in those assessments were (25–75) ng g⁻¹ or even higher, which was above normal content in edible oils. Therefore the analytical recoveries of the proposed method were satisfactorily considering that the addition of metals was equal to the expected content in oil: (5–10) ng g⁻¹ for Cu, Ni and Pb, 0.5 ng g⁻¹ for Cd and 2000 ng g⁻¹ for Fe.

Table 2. Repeatability, analytical recovery, limit of detection (LD) and limit of quantification (LQ), LD and LQ were calculate from calibration slope and from signal variation of blank sample

Parameter of validation	Cu	Cd	Ni	Pb	Fe
Repeatability (<i>n</i> =5)	27	19	53	34	12
Analytical recovery (<i>n</i> =4)	90	90	120	112	9
LD (blank sample, <i>n</i> =20)	6	0.2	12	6	153
LQ (blank sample, <i>n</i> =20)	20	0.6	40	20	510
LD (calibration)	0.12	0.25	4	3	1
LQ (calibration)	0.5	0.75	10	9	4

The limit of detection was calculated by multiplying the calibration slope and the variance of the analyte content in blank sample by three while for the limit of quantification it was multiplied by ten (Table 2). The limit of detection of the proposed method were comparable with published data since Lo Coco et al. (2003) determined the limit of detection of Cd determination in oils by potentiometry of 5 ng g⁻¹, while for metals determined by ET-AAS after direct determination LDs were (1.3–14.9) ng g⁻¹ of the analyte, (Martin-Polvillo et al., 1994; Calapaj et al., 1988; Jimenez et al., 2002) and (10–50) ng g⁻¹ (Karadjova et al., 1998). The exception was Fe since the LD and LQ were higher than the published data. The reason for that was the contamination of samples from the air-borne particles during the long time of digestion.

The parameters of the validation of the proposed method were satisfactory, except relatively high limit of detection and quantification of Fe and low repeatability of Ni determination.

The measurement uncertainty for the proposed method was assessed according to the following equation (1):

$$w = \frac{(\gamma_o - \gamma_{sp}) \times m_r \times f \times d}{m \times f_l} \times f_p, \quad (1)$$

where f_p was the uncertainty of precision factor within the batch, f_l was the uncertainty of analytical recovery, γ_o the uncertainty of sample solution mass concentration, γ_{su} was the uncertainty of blank sample mass concentration, m the uncertainty of sample mass, m_r the uncertainty of sample solution mass and d the uncertainty of dilution factor.

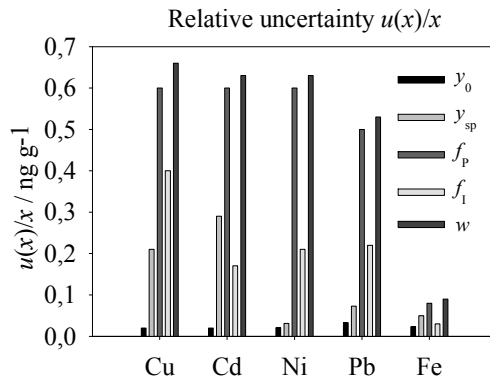

Fig. 1. Relative uncertainties of Cu, Cd, Ni, Pb and Fe content in olive oil determined by ET-AAS after dry ashing

The calculated composed uncertainties of metal contents in olive oil were given in Fig. 1. For all five analytes almost all measurement uncertainty originated from the uncertainty in the precision factor. The great impact of this component on measurement uncertainty was due to the method of sample preparation. Therefore the method could be significantly improved by unifying the conditions of the sample preparation. Since the sample was exposed to air-borne particles for too long, it should be protected by constant flow of air above the sample vessel. Likewise, the temperature of combustion has to be precisely controlled and it should be uniform across the surface of the heating plate and inside the muffle furnace.

Content of Cu, Cd, Ni, Pb and Fe in olive oil samples from Dalmatia

The content of metals in olive oil collected from individual producers from Dalmatia was determined by ET-AAS after dry ashing (Table 3). The results were corrected for blank sample.

The Cu content was similar to the content in Spanish olive oil [$<1.3-86 \text{ ng g}^{-1}$] (Martin-Polvillo et al., 1994) and Italian olive oil [$31-129 \text{ ng g}^{-1}$] (Calapaj et al., 1988), and were lower than previously published data for Dalmatian olive oils [$40-4510 \text{ ng g}^{-1}$] (Zeiner et al., 2005). According to Zeiner et al. (2005) in 79 % of 14 samples analyzed the content of Cu in olive oils from Dalmatia was higher than the maximum amount allowed of 100 ng g^{-1} Cu in vegetable oils (OG, 2005). As with copper, in 36 % of samples analyzed the content of nickel was above maximum allowed amount in edible vegetable oils of 500 ng g^{-1} and in all samples measured the content of Fe was higher than maximal allowed

amount of 1500 ng g⁻¹ in vegetable oils, and 5000 ng g⁻¹ in unrefined oils (OG, 2005). The metal content in previous study might be higher due to the use of wet ashing assisted by microwaves and determination by inductively coupled plasma optical emission spectrometry (ICP-OES) (Zeiner et al., 2005). In this study the samples of olive oil were collected from producers using modern equipment and technologies of olives production, and we collected the samples from individual producers in the olive mill immediately after the extraction of oil and until measurement were kept in original glass bottles in order to minimize the contamination of the sample. Unlike that in the previous study methods of olives production and sample collection and storage were unknown. That showed how in the analysis of trace amounts of metals great care in the manipulation of samples has to be undertaken in order to avoid incidental contaminations.

The content of cadmium was below limit of detection except of one olive oil being 0.7 ng g⁻¹ of Cd. The content was lower than in olive oils from Italy [(1-3.1) ng g⁻¹] measured by ET-AAS after dilution of oil by alcohol solution of KOH (Karadjova et al., 1998). In newer research dry ashing and determination by cathode stripping potentiometry content of cadmium in 10 samples of Italian olive oils was lower than limit of detection of 5.1 ng g⁻¹ (Lo Coco et al., 2003).

The content of nickel (less than 12 ng g⁻¹, except in one sample containing 36 ng g⁻¹) was lower than previously measured in olive oils from Dalmatia [(70- 2260) ng g⁻¹] (Zeiner et al., 2005) and from Italy [(31-55) ng g⁻¹] (Calapaj et al., 1988) and similar to Spanish olive oils (lower than the limit of detection of 14.9 ng g⁻¹) (Martin-Polvillo, 1994).

The content of Pb (lower than 6 ng g⁻¹, except in two olive oils of 7 ng g⁻¹ and 10 ng g⁻¹ of Pb) was similar to previously measured olive oils from Dalmatia (lower than 1 ng g⁻¹) (Zeiner et al., 2005) and Spanish olive oils [(<6.6-15) ng g⁻¹] (Martin-Polvillo et al., 1994) and was lower than in Italian olive oils [(17-32) ng g⁻¹] (Calapaj et al., 1988).

The content of Fe [(<153-1102) ng g⁻¹] was lower than previously reported data for Dalmatian oils [(13100-18460) ng g⁻¹] (Zeiner et al., 2005) and similar to the Spanish [(120-1730) ng g⁻¹] (Martin-Polvillo et al., 1994) and Italian olive oil [(60-355) ng g⁻¹] (Calapaj et al., 1988).

In this study content of Cu, Cd, Ni and Fe of Croatian olive oils was lower than in previous study (Zeiner et al., 2005), and Pb content was similar.

All samples were divided in two groups according to the type of extraction of oil, centrifugation or pressing and one-way ANOVA was performed. We found that the pressing had stronger effect on the content of Cu, Pb and Fe ($P < 0.05$). The content of Cd and Ni were similar under both types of olive extraction.

Table 3. Content of Cu, Cd, Ni, Pb and Fe in olive oils from small Dalmatian olive growers, $n=3$

No.	Locality	Extraction procedure	Content / ng g ⁻¹				
			Cu	Cd	Ni	Pb	Fe
1	Plano	Press	9	< 0.2	< 12	< 6	632
2	Kaštela 1	Press	6	< 0.2	< 12	< 6	543
3	Kaštela 2	Press	8	< 0.2	< 12	< 6	400
4	Rogoznica	Press	53	< 0.2	< 12	7	1102
5	Paklenica 1	Centrifuge	< 6	< 0.2	< 12	< 6	< 153
6	Paklenica 2	Centrifuge	9	< 0.2	< 12	< 6	< 153
7	Brodarica 1	Centrifuge	< 6	< 0.2	< 12	< 6	< 153
8	Brodarica 2	Centrifuge	6	< 0.2	< 12	< 6	< 153
9	Hvar 1	Press	69	< 0.2	36	10	< 153
10	Hvar 2	Centrifuge	< 6	< 0.2	< 12	< 6	< 153
11	Hvar 3	Centrifuge	< 6	< 0.2	< 12	< 6	< 153
12	Korčula 1	Centrifuge	9	0.7	< 12	< 6	210
13	Korčula 2	Centrifuge	6	< 0.2	< 12	< 6	614
14	Vis	Centrifuge	< 6	< 0.2	< 12	< 6	< 153
15	Brač	Centrifuge	12	< 0.2	< 12	< 6	< 153
16	Primošten	Centrifuge	9	< 0.2	< 12	< 6	< 153
17	Podstrana	Centrifuge	< 6	< 0.2	< 12	< 6	< 153

The olive oil samples presented in Table 3 were classified by the cluster analysis into three groups (Fig. 2). Four samples were not classified since all five metals were undetected.

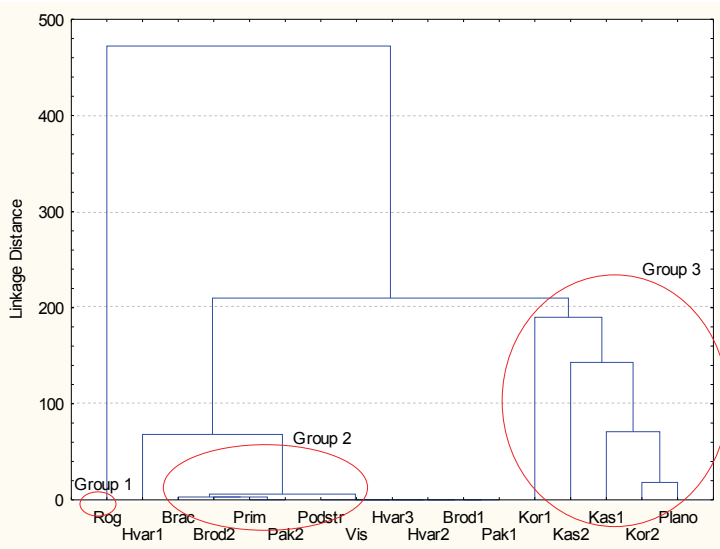

Fig. 2. Cluster analysis of olive oil samples from Dalmatian growers

The sample from Rogoznica was classified in the first group, the samples from Brač, Brodarica, Primošten, Paklenica, Podstrana and Vis in the second group and from Korčula, Kaštela and Plano in the third group. The first group was relatively high in both Cu and Fe content, the second group was low in both Cu and Fe content and the third group was low in Cu content and high in Fe content. All three groups were low in Cd, Ni and Pb. While the first and second group gathered the samples extracted by only one type of extraction, the third group gathered the samples extracted both by press and centrifuge (the samples from Korčula, Kaštela and Plano). Only the third group of samples could be regarded as having the samples from one distinct region, the Middle Dalmatia region.

Conclusions

Among dry ashing, wet ashing and extraction with 0.1 M HNO₃, dry ashing procedure was the most suitable for the preparation of olive oil for the Cu, Cd, Ni, Fe and Pb determination by ET-AAS. The latter method was applied for analyses of metals in samples collected from local family growers of Dalmatia. The samples were classified by cluster analysis into three groups. We identified only one group of samples representing one region. Their metal composition was probably more influenced by the environmental conditions than the type of extraction. Therefore for the successful regional identification of olive oils based on metal content, the samples should be without the effect of the type of extraction and it should perform analyses on larger number of samples per region and on larger number of metals. In the olive oils Cu, Cd, Ni and Pb were very low, and Fe was below 1102 ng g⁻¹. The contents of metals were below maximum allowed amounts of OG (2005). We concluded that techniques of production and processing of olives didn't increase significantly the content of metals in oil. The oils tested were of high quality regarding metal content which was the result of the purchase of new olive mill equipment in recent years (Šimunović, 2005).

References

- Calapaj, R., Chiricosta, S., Saija, G., Bruno, E. (1988): Method for the determination of heavy metals in vegetable oils by graphite furnace atomic absorption spectroscopy, *At. Spectrosc.* 9, 107-109.
- De Leonardis, A., Macciola, V., De Felice, M. (1997): La determinazione del ferro e del rame negli oli vergini d'oliva mediante spettrofotometria ad assorbimento atomico, *Riv. It. Sost. Grasse* 74, 149-154.
- De Leonardis, A., Macciola, V. (2000): Il ferro in oli vergini d'oliva prodotti con il sistema classico, *Industrie Alimentari* 39, 1119-1122.
- De Leonardis, A., Macciola, V., De Felice, M. (2000): Copper and iron determination in edible vegetable oils by graphite furnace atomic absorption spectrometry after extraction with diluted nitric acid, *Internat. J. Food Sci. and Technol.* 35, 371-375.

Topic: Food technology and biotechnology

- Jimenez, M.S., Lopez, A., Castillo, J.R. (2002): Automatic emulsion formation as a sample introduction system for the GF-AAS determination of iron in edible and mineral oils, *At. Spectrosc.* 23, 183-189.
- Karadjova, I., Zachariadis, G., Boskou, G., Stratis, J. (1998): Electrothermal atomic absorption spectrometric determination of aluminium, cadmium, chromium, copper, iron, manganese, nickel and lead in olive oil, *J. Anal. Atom. Spectrom.* 13, 201-204.
- Lo Coco, F., Cecon, L., Ciralo, L., Novelli, V. (2003): Determination of cadmium(II) and zinc(II) in olive oils by derivative potentiometric stripping analyses, *Food Control.* 14, 55-59.
- Martin-Polvillo, M., Albi, T., Guinda, A. (1994): Determination of trace elements in edible vegetable oils by atomic absorption spectrophotometry, *J. AOCS.* 71, 347-353.
- Nash, A.M., Mounts, T.L., Kwolek, W.F. (1983): Determination of ultratrace metals in hydrogenated vegetable oils and fats, *J. AOCS* 60, 811-814.
- Official Gazette of the Republic of Croatia, No.: 16/05, Bylaw on toxins, metals, metalloids and other toxic matter in food.
- Ooms, R., Van Pee, W. (1983): Determination of trace metal content in corn oil by atomic absorption spectroscopy, *J. AOCS.* 60, 957-960.
- Perring, L., Basic-Dvorzak, M. (2002): Determination of Cu, Fe, Ni and Pb in edible oils using microemulsion sample preparation and GF-AAS analyses, *At. Spectrosc.* 23, 201-206.
- Saleh, M.I., Murray, R.S., Chin, C.N. (1988): Ashing techniques in the determination of iron and copper in palm oil, *J. AOCS* 65, 1767.
- Šimunović, V. (2005): Olive growing and oliery in Republic of Croatia, *Pomologia Croatica.* 11, 69-78.
- Varian (1996): Operation manual Star System 2TM, Matthews, USA: CEM Corporation
- Viola, P. (1997): Olive oil and health, Madrid, Spain: International olive oil council, 25-51.
- Zeiner, M., Steffan, I., Juranovic Cindric, I. (2005): Determination of trace elements in olive oil by ICP-AES and ET-AAS: A pilot study on the geographical characterization, *Microchem. J.* 81, 171-176.

Effect of physicochemical variables on descriptive sensory attributes of the taste of *Prošek* wine

UDC: 663.22 : 543.9

I. Budić-Leto¹, G. Zdunić¹, J. Gajdoš Kljusurić^{2*},
I. Tomić-Potrebuješ¹, T. Lovrić²

¹*Institute for Adriatic Crops and Karst Reclamation, Put Duilova 11, 21000 Split, Croatia*

²*Faculty of Food Technology and Biotechnology, Pierottijeva 6, 10000 Zagreb, Croatia*

Summary

Sweet wine *Prošek* found on the market is obtained from selected Dalmatian varieties of grapes using specific production technologies. Two types of *Prošek* wine were experimentally produced from dried grape cv. *Plavac mali* and *Pošip* using traditional technology. The analysis of the basic physicochemical parameters of *Prošek* as well as analysis of total phenols, total anthocyanins, vanillin index, proanthocyanidins and the antioxidant activity using the Briggs-Rauscher method was conducted. In this paper sensory assessment of *Prošek* wine was related to physicochemical variables using multivariable analysis (factor analysis and principal components) with the aim to classify the properties into logical groups as well as to identify the effect of physicochemical parameters on individual sensory attributes of the wine. The results indicated that the fullness of the wine was significantly associated with the content of dry extract and even to a greater extent with the content of total phenols, and regarding *Plavac mali* also with the content of total anthocyanins ($p < 0.05$). The bitterness of *Prošek* wine is in inverse proportion to the content of total phenols, and astringency is inversely proportional to proanthocyanidins. The sweetness of *Prošek* demonstrated moderate correlation with alcohol content ($r = 0.5$), while the acidity of *Prošek* wine revealed a significant correlation with the variables of volatile and non-volatile acidity ($p < 0.05$).

Keywords: dessert wine *Prošek*, sensorial analysis, physicochemical analysis, FA, PCA

Introduction

The most famous sweet wine in Croatia is *Prošek*, which is specifically produced in Dalmatia. It is traditionally produced by alcoholic fermentation of the dried grape pomace or the pomace of the grapes ripening on the vine for a longer time. The unique, delicious aroma of *Prošek* wine originates from dried grapes, and a special vinification technology gives specific characteristics of *Prošek*.

The aim of this paper is to understand the wine acceptance in order to create the best technological model of *Prošek* despite the fact that *Prošek* produced by traditional technology exists on the Croatian market. On the Croatian wine

*. jgajdos@pbf.hr

market, there are a few *Prošek* wines but without a defined technological model because producers use different ways of production (cultivars, drying process of grapes or concentration of sugar in grape). This requires the integration of objective descriptive sensory data with chemical and physical data.

The paper briefly discusses sensory and physicochemical information in the context of the two different types of *Prošek* wine. One type of *Prošek* is produced from red cultivar *Plavac mali* and the other type is produced from white cultivar *Pošip*. This information needs to be as meaningful as possible and the results must be grounded on multivariate analysis. Such treatment can provide a more reliable representation of the inter-relationships between physical and chemical properties and sensorial evaluation (Williams et al., 1998; Bueno et al., 2010). This work contributes to the technology of the production of traditional *Prošek*.

Material and Methods

Grapes and drying process

In harvest 2007 at technological ripeness of cultivars *Plavac mali* and *Pošip*, grapes were picked up from the vineyards of *Pelješac* and *Korčula*, respectively. The grapes were put to dry in a greenhouse for 14 days (3-17 October) for *Plavac mali* and 7 days for *Pošip* (9-15 September).

Vinification of Plavac mali

Dried grapes were crushed and destemmed, after which Endozym cultivar (30 g/100 kg) and potassium metabisulphite (15 g/hL) were added to the pomace. The pomace was divided into 3 equal parts and put into inox containers. Alcoholic fermentations were done in duplicate using commercial yeasts (*Saccharomyces cerevisiae* var. *uvarum*, 30 g/hL, AEB s.p.a., Brescia, Italy) prepared according to the manufacturer's instructions. Maceration took 5 days and the pomace was punched down twice daily, after which it was pressed on the hydraulic press (pressure <2 bar). The must was put in 10-litre glass vials, where the alcoholic fermentation continued. Fermentation was controlled by measuring the temperature and determining the reducing sugars. Temperature during fermentation was between 22 and 24 °C. The first racking was done 29 days, and the second 184 days (6 months) after the beginning of fermentation. After the second racking, *Prošek* was bottled.

Vinification of Pošip

Dried grapes were crushed, destemmed and sulphated. After 4 hours of skin contact, the must was racked into 10-litre glass containers, and then inoculated with selected yeasts (Fermol Cryoaromae, *Saccharomyces cerevisiae* var. *uvarum*, 30 g/hL, AEB s.p.a., Brescia, Italy) prepared according to the manufacturer's instructions. Alcoholic

fermentation was done in triplicate. After the completion of alcoholic fermentation, *Prošek* was racked, sulphated and left to mature. Temperature during fermentation was between 22 and 24 °C. The first racking was done 45 days, and the second 184 days (6 months) after the beginning of fermentation, after which *Prošek* was bottled.

Determination of total phenols, anthocyanins, vanillin index and proanthocyanidins

Total phenols, anthocyanins, vanillin index and proanthocyanidins were determined using spectrophotometric measurements according to described methods (Singleton and Rossi, 1965; Rigo et. al., 2000). Conventional parameters, such as alcohol content, total extract, reducing sugars, total acidity and volatile acidity were measured according to the EU methods (1990).

Descriptive sensory analysis

Descriptive analysis was used to evaluate the sensory characteristics of *Prošek* such as fullness, acidity, sweetness, bitterness and astringency. It was done by the panel of 10 professionals (wine makers who are expert in the sensory analysis of traditional *Prošek* wine), 6 female and 4 male. The evaluations were done at the Institute for Adriatic Crops and Karst Reclamation in Split, where standard conditions for sensory evaluation were kept. Wine samples (25 mL) were served in standard wine tasting glasses coded with random 3-digit numbers at a temperature between 15 and 17 °C. Descriptive sensory analysis was done in June of the following year. Sensory descriptors of wine such as fullness, acidity, sweetness, bitterness and astringency were evaluated with a number from 0 to 9.

Statistical analysis

Interactions between the observed sensory characteristics of flavour and the monitored physicochemical parameters for *Prošek* wine were analyzed using the software package Statistica v. 9. Chemometric analysis was used to answer the question which of the examined sensorial characteristics (fullness, sweetness, sourness, bitterness or astringency) is associated with which of the physicochemical parameters like total phenols, total anthocyanins, vanillin index, proanthocyanidins and antioxidant activity. In order to determine the relationships and differences, cluster analysis (CA), factor analysis (FA) and principal component analysis (PCA) were used.

Results and Discussion

In Table 1 average values of the chosen physicochemical properties of *Prošek* produced by the traditional technology are presented. The use of principal component analysis in identification of similarities or differences of the same wine from different grapes, *Pošip* or *Plavac mali*, is presented in Fig. 1, explaining about 85 % of all

variations between the observed samples. The *Prošek* produced from *Pošip* grape is validated as a significantly different wine (concerning sensorial and physicochemical properties). This is in accordance with the results published by Buratti et al. (2007), Cadot et al. (2010) and Sánchez Palomo and co-workers (2005).

Table 1. Average values for physicochemical parameters monitored for *Prošek* wine, raw material and the added cultures.

Physicochemical parameters	Grape varieties	
	<i>Pošip</i>	<i>Plavac mali</i>
Total phenols	550.00	3233.00
Total anthocyanins	0.00	232.60
Vanillin index	0.00	1480.00
Proanthocyanidins	0.00	2674.00
AoA-BR	199.00	833.00
Alcohol content	10.53	13.36
Total extract	334.15	261.25
Reduced sugar	280.66	206.58
Total acidity	7.43	7.90
Non-volatile acidity	5.57	6.03

AoA-BR=antioxidant activity according the Briggs-Rauscher method (inhibition time, s)

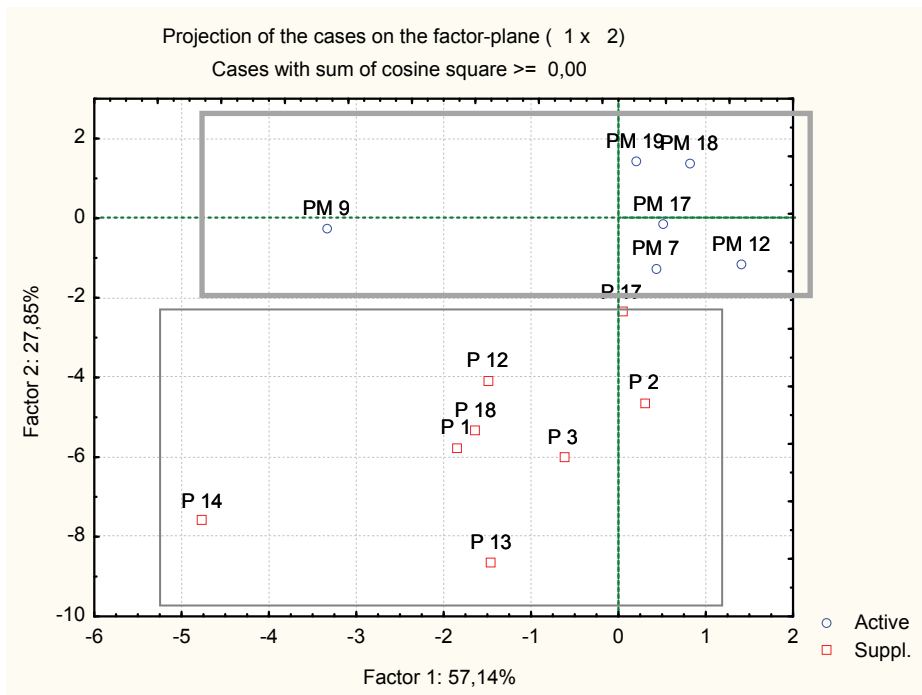

Fig. 1. Grouping of *Prošek* wines using PCA, based on the physicochemical and sensorial properties of the wine obtained for the evaluated wines (wine from grape varieties: P-*Pošip*; PM-*Plavac mali*)

Sensory properties of the wine are presented with the aim to evaluate the intensity of the wine flavour. The results (Table 2) indicate the different flavour profile regarding the row material (grape) as well as the technology of the production what was also observed in the production process (Herjavec et al., 2007; Cerezo, et al., 2010) and different enzymatic treatments (Sánchez Palomo, 2005).

Table 2. Evaluation of the sensory characteristics of *Prošek* wine

Grape varieties	Sensory characteristics				
	fullness	acidity	sweetness	bitterness	astringency
<i>Pošip</i>	5.6	4.1	6.9	1.8	1.8
<i>Plavac mali</i>	8.2	5.0	7.8	1.4	2.9

Five flavour characteristics were evaluated and according to the dendrogram presented in Fig. 2, fullness and sweetness of *Prošek* are the dominant flavours of the wine, followed by bitterness and astringency. The sourness of the wine is insignificant because *Prošek* is a dessert wine and the dominant flavours, as mentioned above, are sweetness and fullness.

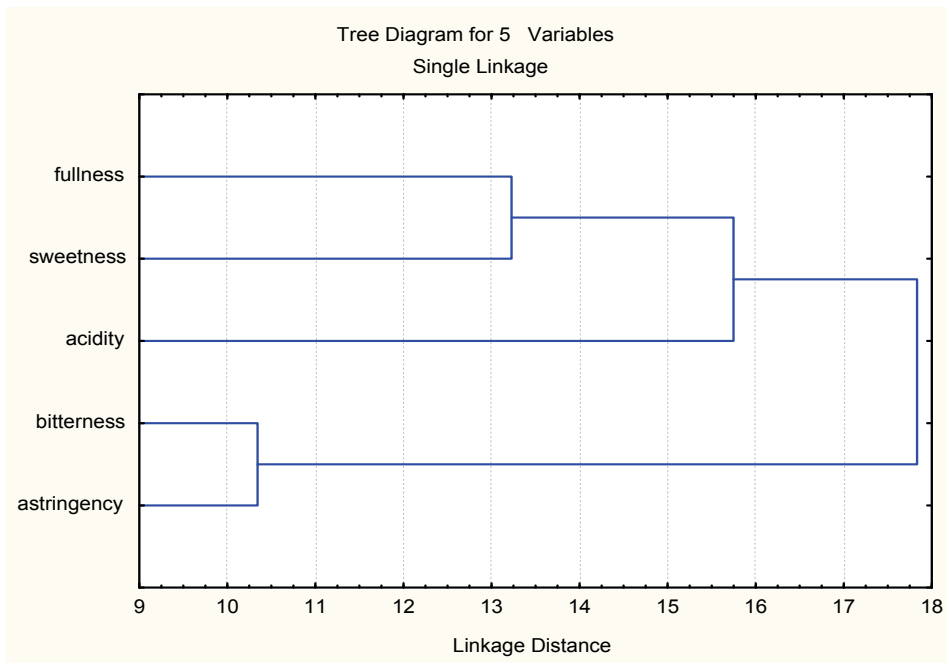

Fig. 2. Grouping of the observed flavour parameters for *Prošek* wine

Sensory changes can be roughly attributed to chemical changes during wine fermentation, especially aldehyde formations, particularly in red wines such as *Prošek* from grape *Plavac mali* because of the rapid oxidation forming a large amount of aldehydes in the first days of fermentation. However, other, yet unidentified factors also have an influence on the sensorial properties of wine (Bueno et al., 2010).

Statistical methods applied in this work could represent a rational operative procedure for building regression models with real predictive capability, as it was done by Buratti et al. (2007).

In order to detect possible linkage between wine flavour characteristics and the observed physicochemical characteristics, the PCA correlation circle was used (not presented). The first two dimensions explain all of the variance among the samples. Sweetness is in the best correlation with total phenols, fullness with total anthocyanins, and sourness with total sourness. It seems that the aroma of *Prošek* is also a result of new compounds that are generated, as it is concluded in the studies of Sánchez Palomo and co-workers (2005) and Bueno et al. (2010).

Conclusions

Wines from different grape varieties (*Pošip* and *Plavac mali*) showed differences in physicochemical composition and in the intensity of the observed sensorial attributes.

About 85 % of all interactions between the observed samples are explained using PCA, but it is evident that other yet unidentified factors have an influence on the wine properties.

The present results demonstrate the possibility of using chemometric methods in order to obtain a rapid and objective way of information about the relationship between the monitored data of wines, regarding physicochemical and sensorial wine properties as input/output variables. Applied statistical methods could represent a rational operative procedure for building regression models with predictive capability.

Acknowledgements

This study was supported by the Ministry of Science, Education and Sports of the Republic of Croatia, Project Biotechnological Parameters of Premium-quality Dalmatian Dessert Wine-*Prošek* (091-091468-0452). We thank Ms Marija Pecotić and Winery Blato 1902 for providing the grape. We also gratefully acknowledge all judges for their contribution to sensory evaluation.

References

- Bueno, M., Culleré, L., Cacho, J., Ferreira, V. (2010): Chemical and sensory characterization of oxidative behavior in different wines, *Food Research International*. 43 (5), 1423-1428.
- Buratti, S., Ballabio, D., Benedetti, S., Cosio, M.S. (2007): Prediction of Italian red wine sensorial descriptors from electronic nose, electronic tongue and spectrophotometric measurements by means of Genetic Algorithm regression models, *Food Chemistry*. 100(1), 211-218.
- Cadot, Y., Caillé, S., Samson, A., Barbeau, G., Cheyrier, V. (2010): Sensory dimension of wine typicality related to a terroir by Quantitative Descriptive Analysis, Just About Right analysis and typicality assessment, *Analytica Chimica Acta*. 660 (1-2), 53-62.
- Cerezo, A.B., Tesfaye, W., Soria-Díaz, M.E., Torija, M.J., Mateo, E., Garcia-Parrilla, M.C., Troncoso, A.M. (2010): Effect of wood on the phenolic profile and sensory properties of wine vinegars during ageing, *Journal of Food Composition and Analysis*. 23 (2), 175-184.
- E.U. (1990) Official Journal of the European Community L 2676/90 Commission Regulation
- Herjavec, S., Jeromel, A., Da Silva, A., Orlic, S., Redzepovic, S. (2007): The quality of white wines fermented in Croatian oak barrels, *Food Chemistry*. 100 (1), 124-128.
- Hernández, E., Raventós, M., Auleda, J.M., Ibarz, A. (2010): Freeze concentration of must in a pilot plant falling film cryoconcentrator, *Innovative Food Science and Emerging Technologies*. 11 (1), 130-136.
- Mendes-Pinto, M.M. (2009): Carotenoid breakdown products the-norisoprenoids - in wine aroma, *Archives of Biochemistry and Biophysics*. 483 (2), 236-245.
- Di Natale, C., Paolesse, R., Burgio, M., Martinelli, E., Pennazza, G., D'Amico, A. (2004): Application of metalloporphyrins-based gas and liquid sensor arrays to the analysis of red wine, *Analytica Chimica Acta*. 513 (1), 49-56.
- Povhe Jemec, K., Raspor, P. (2005): Initial *Saccharomyces cerevisiae* concentration in single or composite cultures dictates bioprocess kinetics, *Food Microbiology*. 22 (4), 293-300.
- Rigo, A., Clementi, G., Rossetto, M., Scarpa, M., Vrhovsek, U., Mattivi, F. (2000): Contribution of proanthocyanidins to the peroxy radical scavenging capacity of some Italian red wines, *J. Agric. Food Chem.* 48, 1996-2002.
- Singleton, V. L., J. A. Rossi, (1965): Am. J. Colorimetry and total phenolics with phosphomolybdic-phosphotungstic acid reagents, *Am. J. Enol. Vitic.* 16, 144-158.
- Stefanon, C.A., Colombo, M., de M. Bonesi, C., Marzarotto, V., Vanderlinde, R., Salvador, M., Henriques, J.A.P. (2010): Antioxidant activity of sparkling wines produced by Champenoise and Charmat methods, *Food Chemistry*. 119 (1), 12-18.
- Sánchez Palomo, E., Diaz-Maroto Hidalgo, M.C., González-Viñas, M.Á., Pérez-Coello, M.S. (2005): Aroma enhancement in wines from different grape varieties using exogenous glycosidases, *Food Chemistry*. 92 (4), 627-635.
- Williams, A.A., Rogerst, C.A., Collins, A.J. (1988): Relating chemical/physical and sensory data in food acceptance studies, *Food Quality and Preference*. 1 (1), 25-31.

Comparison of free and comercial software packages for engineering problem solving and education

UDC: 681.3.066 : 378.1

F. Čačić*, J. Lukinac, D. Magdić

University of Josip Juraj Strossmayer in Osijek Faculty of Food Technology Osijek, Franje Kuhaca 20, 31000 Osijek, Croatia

Summary

Engineering is application of scientific principles in real life problem solving, or in other words solving practical problems with application of accumulated scientific facts and more or less personal experience. Solving engineering problems often means application of numerical methods for differential equation solving, no matter what engineering branch is in concern. With fast development of personal computers in last two decades of last century, numerical methods moved from mainframe computers in research centers to widely available program packages written for PCs. This transition resulted in development of tools for product design, modeling and simulation which now could be used at universities for education as well as scientific work. *Matlab*[®] is dominant commercial package today, but also there is number of free packages like *Scilab* or *Octave*. This work focuses on comparison of free software packages with commercial reference to determine their fitness to be used as tool for modeling and simulation as well as teaching engineering principles.

Keywords: Matlab, Scilab, Scientific software, simulation

Introduction

Often students and young engineers found themselves overwhelmed with tasks that they need to solve in limited time, and they need tools that can help them to minimize their effort and maximize productivity. Today every engineer and student is forced to use personal computer in order to fulfill their tasks, homework's, calculations and reports. Computer literacy is obligatory today, but mostly it only assumes use of office applications (*MS Office* or *OpenOffice*,...), which is not enough for students in engineering fields of study. First encounter with engineering software most students have at faculties or after graduation at research institutes, and once they learn to use one software package it is very hard to expect that they will move to another one. In Croatia Ministry of Science, Education and Sports had formed referral centers for scientific software to help academic community to acquire and use requested engineering software. Some examples of these centers are center for *MathWorks Matlab*

* fcacic@ptfos.hr

(<http://www.matlab.fer.hr/>), *Wolfram's Mathematica* (<http://mrc.systemcom.hr/>) and computer aided engineering CAE (<http://www.cae-refcentar.fsb.hr/>) center. Every software and license obtained from this centers are paid from state budget (Ministry of Science, Education and Sport), in seven years (2002-2009) only CAE center issued 7391 licenses for 50 software packages to 34 institutions which is substantial amount of money.

Current trend in Europe is minimizing state expenses, and some of biggest European countries (Germany, France, ...) promote moving from proprietary to open source software in all government institutions (from public services, elementary schools to universities) replacing operating systems (*Microsoft Windows* with *Linux*) and applications. Aim of this paper is comparison of commercial, well known software package *Matlab* with open source alternative *Scilab* as tool for scientific calculations, simulations and teaching, and their availability on different platforms. Comparison is focused on features that are useful for teaching engineering subjects.

Matlab (Matrix laboratory) was created in late 1970's by Cleve Moler who was chairman of computer science department at the University of New Mexico. It was designed with intention to allow students to access *LINPACK* and *EISPACK* libraries without need to learn *Fortran*. Formally MathWorks was founded in 1984 by Cleve Moler, Steve Bangert and Jack Little and *Matlab* as commercial tool was available at the market. *Matlab* is today *de facto* standard and leader in control design engineering and also used in education, in particular teaching of linear algebra, numerical analysis. *Matlab* is used in more than 5000 universities worldwide*, and it is estimated that more than one million people use it for their work.

Scilab was created in 1990 by researchers from French National Institute for Research in Computer science and Control (Institut Nationale de Recherche en Informatique et en Automatique, INRIA) and École nationale des ponts et chaussées (ENPC). In 2003 *Scilab Consortium* was formed to broaden contributions and promote *Scilab* as worldwide reference software in academia and industry, and in 2008. *Scilab Consortium* joined with *Digiteo Foundation*.

Materials and Methods

Software packages used in this paper are *Matlab* 2010a, *Simulink*, MathWorks, trial version, *Scilab*, 5.2.2 and 5.3.0 beta3, Digiteo INRIA. Programs were obtained from Internet (*Matlab*[®] from www.mathworks.com; *Scilab* from www.scilab.org). Both software packages were tested on same PC computer, based on INTEL Dual Core processor (E-5200, 2.5 GHz), 4 GB (DDR2 – 800) RAM under Linux operating system Kubuntu 10.04 64-bit version. Programs

*http://www.mathworks.com/academia/student_version/

were installed following install instructions with default settings. It is important to emphasize that *Matlab* is not free software and *Scilab* is freely (CeCILL license) available as download from Internet for Windows, Mac OSX and Linux in 32-bit and 64-bit versions.

Some simple engineering problems were chosen to be solved by selected software packages as examples, which represent most common problems encountered during engineer study program, namely differential equation solving, integration, modeling, optimization and simulation. To compare speed of *Matlab* 2010a and *Scilab* 5.2.2, test script (Steinhaus, 2008) was used to measure time needed to complete specific tasks.

Results and Discussion

Both Matlab and Scilab are available as installation packages on all major platforms. There are quite few options and types of installation possible, from default installation on single computer to client/server installations (Table 1).

Table 1. Installation options and features

Function	Matlab 2010a	Scilab 5.2.2
Standard OS installation	+	+
Customizable installation	+	+
Silent installation mode	+	+
Client/Server installation	+	+
License management for client/server usage	+	No need - freeware
Online check for updates	+	-

Primary focus of these programs are matrix calculations, they are primary used for numeric calculations in contrast to applications like *Wolfram's Mathematica* and *MapleSoft Maple* which are more symbolically oriented software (Bordeianu *et al.*, 2008). Some of general mathematical features are showed in Table 2.

Most commonly encountered problem in chemical, food or other engineering is solving differential equations or systems of equations because it is mathematical way for expressing change in composition, concentration or dynamics of observed system. It is possible to solve wide range of engineering problems (equations) with built in solvers or with additional toolboxes as shown in Table 2.

Another very commonly encountered problem in engineering is optimization of some kind, process or product optimization which can be solved with numerous optimization algorithms. *Matlab* has two toolboxes that are used for optimization problems (Calberg, 2009): Optimization toolbox and Genetic algorithm and Direct search toolbox. *Scilab* optimization capability's are close to *Matlab's* in sense of available functions and they are either embedded in *Scilab* or available as toolboxes which are mostly just interfaces to optimization

libraries (Baudin et al., 2010). Generalized overview of optimization problem solvers for both packages are given in Table 2.

Table 2. Comparison of available features

Functions	Matlab 2010a	Scilab 5.2.2
Eigenvalues		
Eigenvalues	+	+
Eigenvectors	+	+
Matrix analysis		
Characteristic polynomial	+	+
Determinant	+	+
Hadamard matrix	+	-
Hankel matrix	+	-
Hilbert matrix	+	+
Householder matrix	+	+
Inverse matrix	+	+
Kronecker product	+	+
Pascal matrix	+	-
Toeplitz matrix	+	+
Upper Hessenberg form	+	+
Decompositions		
Cholesky decomposition	+	+
Crout decomposition	+	-
Dulmage-Mendelsohn decomposition	+	-
LU decomposition	+	+
QR decomposition	+	+
Schur form of quadratic matrix	+	+
Smith normal form	\$	-
Singular value decomposition	+	+
Optimization		
Optimization - linear models (Unconstr. / Constr.)	+/+	+/+
Optimization - nonlinear models (Unconstr. / Constr.)	\$\$	+/+
Optimization - quadratic models (QP) (Unconstr. / Constr.)	\$\$	+/+
Equation solver		
Linear equation solver	+	+
Non-linear equation solver	\$	+
Ordinary Differential Equation solver	+	+
Partial Differential Equation solver	+	*

\$-additional toolbox, separate purchase; *-additional toolbox free

Most of software packages for numerical computation has graphical capability's built in for calculations results representation. *Matlab* and *Scilab* are well equipped with such functionality (Table 3).

Table 3. Graphical functionality

	Matlab 2010a	Scilab 5.2.2
2D Graphics		
Area charts	+	-
Bar charts	+	+
Bubble Plot	+	-
Error bars	+	+
Histograms	+	+
Log Plot	+	+
Log-log Plot	+	+
Pie charts	+	+
Polar Plot	+	+
XY Plot	+	+
3D Graphics		
Charts	+	+
Contour plot	+	+
Height colors	+	+
Spectral plots	+	-
Surface plot	+	+
XYZ plot	+	+

Greatest feature of *Matlab* for teaching mathematical modeling, automation theory and simulation of dynamical systems is *Simulink*. It is a interface to a graphical block diagramming tool and customizable set of block libraries, also it is closely integrated with *Matlab* which provides immediate access to an extensive range of tools for algorithm development, analyzing and visualize simulations, define parameters and test data (Simulink 7.6 product description). *Scilab* has similar tool called *Xcos* (previously *Scicos*), which is installed along with *Scilab*. *Simulink* and *Xcos* are based on large numbers of building blocks (ready to use code) which represents signal sources, mathematical operations, signal operations, matrix calculations and signal sinks for gathering simulation results. All available block are arranged in palettes logically grouped by their function for easier navigation (Fig. 1).

These tools are significantly easier to use because there is no programming required, models are intuitively constructed by dragging and connecting available blocks (Fig. 2). Also, there is possibility to create new blocks form existing ones (superblock feature or mask) or completely new but that requires programming skills (*C*, *Fortran*,...).

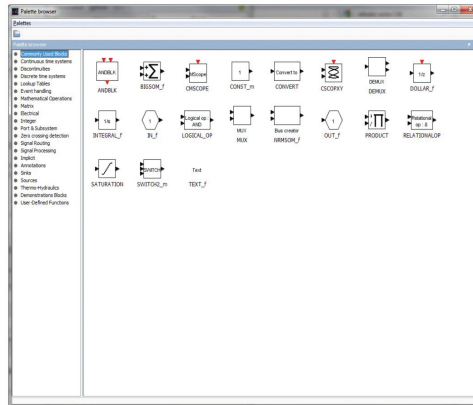

Fig. 1. Block organization in Scilab palette browser

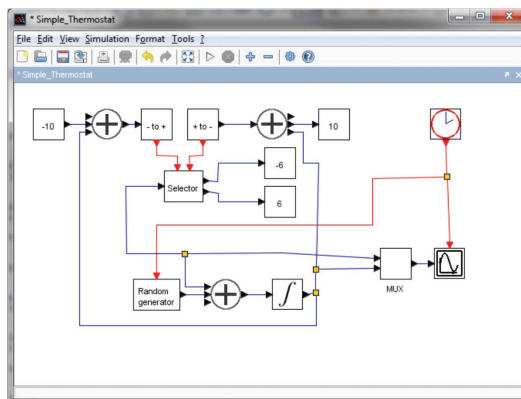

Fig. 2. Xcos model example

Conclusions

Both packages provides to students and researchers with tools which can be easily learned and are easier to use because there is vast number of ready available functions and algorithms and there is no need to program them from scratch in C, C++ or some other language.

Matlab is number one software package for modeling and simulation, but it is commercial software which is expensive. Scilab tends to be a free version *Matlab*, closely representing *Matlab's* syntax, and through every version there are more and more functionality added.

Still *Matlab* has more capability's, but when functionality to price ratio is in concern (in education, private sector), *Scilab* is clear winner because it is freeware published under Cecill licence (2006).

References

- Baudin M., Couvert V., Steer S. (2010): Optimizing in Scilab, The Scilab Consortium – Digiteo/INRIA,
http://www.scilab.org/content/download/1390/13697/file/optimization_in_scilab.pdf (06.09.2010.)
- Bordeianu C.C., Besliu C., Jipa Al., Felea D., Grossu I.V. (2008): Scilab software package for the study of dynamical systems, *Computer Phys. Commun.* 178, 788-793.
- Carlberg, K. (2009): http://stanford.edu/~carlberg/SummerSchool.d/OPT_Matlab.pdf, accessed 06. 09. 2010.
- Commissariat à l'Energie Atomique, Centre National de la Recherche Scientifique, Institut National de Recherche en Informatique et en Automatique: CeCILL free software license agreement, http://www.cecill.info/licences/Licence_CeCILL_V2-en.html, 2006.
- MathWorks: Simulink product description,
<http://www.mathworks.com/products/simulink/description1.html>, 06.09.2010.
- Steinhaus, S.: Comparison of mathematical programs for data analysis,
<http://www.scientificweb.de/ncrunch/>, 2008.

***Lactobacillus plantarum* 1K from “SLAVONSKI KULEN” as natural probiotic starter culture**

UDC: 637.523 (497.54)

J. Frece^{1*}, K. Markov¹, D. Čvek¹, D. Kovačević²,
I. Gobin³, F. Delaš¹

¹University of Zagreb, Faculty of Food Technology and Biotechnology, Laboratory for general microbiology and food microbiology, Pierottijeva 6, 10000 Zagreb, Croatia

²University of Josip Juraj Strossmayer in Osijek, Faculty of Food Technology Osijek, Department for food technology, Franje Kuhača 20, 31000 Osijek, Croatia

³University of Rijeka, Medical Faculty of Rijeka, Laboratory for microbiology, 51000 Rijeka, Croatia

Summary

The influence of the oral treatment with probiotic strain *Lactobacillus plantarum* 1K isolated from „Slavonski kulen” on an oral infection of mice by *Salmonella* sp. was investigated. Mice were fed with milk-based diets supplemented with *L. plantarum* 1K for three days prior and following an oral challenge with *Salmonella* sp. Survival, competition, adhesion and colonization of *L. plantarum* 1K and influence on infection with *Salmonella* sp. were monitored in the gastrointestinal tract of mice. After the oral treatment of mice with *L. plantarum* 1K in combination with *Salmonella* sp., the total number of lactic acid bacteria in faeces and in intestinal homogenates was increased, on the contrary, the total number of enterobacteria and *Salmonella* sp. was reduced. These results demonstrate that *L. plantarum* 1K can reduce the severity of infection due to the pathogenic *Salmonella* sp., and suggest that this reduction is associated with competitive exclusion in the intestinal tract. Considering that *L. plantarum* 1K has demonstrated the basic functional criteria for the selection of probiotic strains, as such, it can be used as functional autochthonous starter culture for fermented meat products.

Keywords: probiotic, *Lactobacillus plantarum*, *Salmonella* sp., infection, Slavonski kulen

Introduction

Nowadays, increasing number of studies is focused on the isolation and identification of autochthonous functional starter cultures, with the aim of developing new functional meat products, which will be recognized and labelled as autochthonous due to the influence of climate and vegetation of the region in which they are produced (Frece, 2007). Lactic acid bacteria (LAB) play an important role in meat preservation and fermentation processes and are considered technologically fundamental. They are able to decrease pH by lactic acid production, produce bacteriocins to prevent the growth of pathogenic and

*. jgoreta@pbf.hr

spoilage microorganisms, provide diversity by the modification of raw material to obtain new sensory properties, improve the safety, the stability and the shelf life of meat products (Fontana et al., 2005; Frece et al., 2005 a, b, c; Frece et al., 2009) and they also contribute to the development of flavour, colour and texture (Kovačević, 2001). One of the most important properties of LAB as probiotics is protection against pathogens in the intestinal tract of the host (Šušković et al., 2001; Kos et al., 2003, Frece et al., 2005c; Frece et al., 2009). The role of antimicrobial compounds produced by probiotic strains as prophylactic agents against enteric infections is crucial and well documented (Šušković et al., 2001, Kos et al., 2003; Golowczyc et al., 2007). The antimicrobial activity of starter cultures and probiotic bacteria has been attributed to the production of metabolites such as organic acids (lactic and acetic acid), hydrogen peroxide ethanol, diacetyl, acetaldehyde, other low molecular mass compounds with antimicrobial activity and bacteriocins (Šušković et al., 2001).

Enteric bacterial pathogens represent a major cause of gastrointestinal disease worldwide. Current measures to control gastrointestinal infections rely heavily on the use of antimicrobial chemotherapeutic and chemoprophylactic agents. However, widespread use of antibiotics in public health is discouraged due to complications including the emergence of drug-resistant strains and the potential for chronic toxicity (Shu and Harsharnjit, 2002). Therefore, there is an effort to develop alternative, non-pharmaceutical strategies for controlling gastrointestinal bacterial infection (Vinderola et al., 2007, Spinler et al., 2008).

Probiotic bacteria, mainly lactic acid bacteria (LAB) and bifidobacteria, are previously shown to have beneficial effects on immunomodulation, alleviation and prevention of diverse intestinal disorders (Servin and Coconnier, 2003; Golowczyc et al., 2007). This could be due to their property to prevent the adherence, establishment and invasion of specific enteropathogens (Servin, 2004, Silva et al. 2004; Frece et al., 2005a; Matijašić et al., 2006). Several mechanisms have been proposed: contribution to mucosal barrier function, competitive exclusion, modulation of the immune response, coaggregation to pathogens, decreasing of the luminal pH via the production of lactic acid and secretion of specific compounds such as bacteriocins (Coconnier et al., 2000; Kos et al., 2003, Frece et al., 2005a; Golowczyc et al., 2007; Kos et al., 2008; Frece et al., 2009).

Considering that *L. plantarum* 1K has satisfied the basic criteria for selection of probiotic strains *in vitro* conditions, and showed strong antimicrobial activity against *Salmonella* sp. (results were not shown), *in vivo* studies in experimental mice were carried out.

Therefore, the aim of this study was to investigate survival, competition, adhesion and colonization of *L. plantarum* 1K in the gastrointestinal tract of mice, and if the oral treatment with probiotic strain *L. plantarum* 1K had the protective effect against *Salmonella* sp., by influencing the intestinal microflora of mice.

Materials and Methods

Bacterial strains and growth conditions

Probiotic strain *L. plantarum* 1K and *Salmonella* sp. are from the culture collection of the Department of Biochemical Engineering, Laboratory for general microbiology and food microbiology, University of Zagreb. *L. plantarum* K1 was stored at $-70\text{ }^{\circ}\text{C}$ in the Man Ragosa Sharpe (MRS) broth (Difco, Detroit, MI, USA) with 30 % (v/v) glycerol. *Salmonella* sp. was stored at $-70\text{ }^{\circ}\text{C}$ in the Brilliant green broth (Biolife, Milano, Italy) with 30 % (v/v) glycerol.

Mice

4 months old female Swiss albino mice weighing from 22 to 24 g were used after a month quarantine period. Each experimental group consisted of 4 mice, housed in cage, kept in a controlled atmosphere (temperature $22 \pm 2\text{ }^{\circ}\text{C}$; humidity $55 \pm 2\text{ }%$) with a 12 h light/dark cycle. Mice had continual access to water and were fed *ad libitum* on skim milk powder (SMP)-based diet contained SMP (53 %), corn oil (8 %), vitamin (5 %), minerals (5 %), corn flour (28 %), and cellulose (1 %). All experimental procedures were carried out according to the standards set in the “Guide for the Care and Use of Laboratory Animal’s of the National Research Council” (1996).

Feeding procedures and challenge with Salmonella sp.

L. plantarum 1K cells were cultured in MRS-broth and *Salmonella* sp. was cultured in the Brilliant green broth, both aerobically at $37\text{ }^{\circ}\text{C}$ for 18 hours. Cells were removed by centrifugation at 10 000 g for 2 min, washed three times and resuspended in sterile 0.5 % NaCl solution to final concentration of 1×10^{11} viable bacterial cells per ml for *L. plantarum* 1K, and final concentration of 1×10^3 viable bacterial cells per ml for *Salmonella* sp. Mice were orally treated with 200 μl of prepared suspension of bacterial cells *L. plantarum* 1K during 7 consecutive days. On a 3rd day, single oral infection with *Salmonella* sp. followed. Another group (4 mice) was infected with 200 μl of prepared suspension of *Salmonella* sp. cells. Control group (4 mice) was fed only with standard rodent feed. The group of mice (4 mice) treated with 200 μl of prepared suspension of *L. plantarum* 1K cells during 7 consecutive days, were negative control.

Faecal sampling

After feeding period of 7 consecutive days, the survival of potential probiotic strain *L. plantarum* 1K and the infection of *Salmonella* sp., during transit through gastrointestinal tract of mice was determined in faecal samples.

Additionally, the influence of a challenge by *Salmonella* sp., alone and in combination with potential probiotic strain, on *Enterobacteriaceae* and *Salmonella* sp. count in faeces was also monitored after feeding period. 1g wet weight samples were homogenized in 1 ml sterile 0.5 % NaCl solution and serially diluted before plating on non-selective medium Peptone yeast extract glucose agar (PYEG, Biolife, Milano, Italy) and selective media: MRS-agar for LAB count, Violet red bile glucose agar (VRBG, Biolife, Milano, Italy) for *Enterobacteriaceae* count and finally Brilliant Green Phenol Red agar (BGPR agar, Merck, Darmstadt, Germany) for the *Salmonella* sp. counts. The plates were incubated aerobically for 48 h at 37 °C. LAB, *Enterobacteriaceae* and *Salmonella* sp. were identified on the basis of colony morphology, Gram staining, cell morphology, the catalase reaction. The identity of bacteria was also confirmed using API 50CH and API 20E identification kits (BioMérieux, France).

In vitro adhesion test

In vitro adhesion test was done according Frece et al., 2005 a, b, c.

In vivo adhesion test

Adhesion ability of examined probiotic strain was determined in homogenates of small and large intestine of Swiss albino mice 7 days after feeding with *L. plantarum* 1K with and without infection of mice with *Salmonella* sp. The influence of a challenge by *Salmonella* sp., alone or in combination with potential probiotic strain, on *Enterobacteriaceae* and *Salmonella* sp. count in the intestine of mice, was also monitored 7 days after experimental period. The samples of small and large intestine, 5 cm long, were gently rinsed with sterile 0.5 % NaCl solution and homogenized using a Teflon homogeniser (1 g of tissue samples per ml of sterile 0.5 % NaCl solution), and serially diluted before plating in non-selective and selective media as it was described in the section *Feeding procedures and challenge with Salmonella* sp.

Immunization

The potential probiotic bacteria were orally administrated to each mice (4 mice/group) eight times over a period of eight successive days. A dose of 200 µl of sterile 0.5 % NaCl solution containing 1×10^{11} viable bacterial cells of *L. plantarum* 1K was daily directly given to each mice, 3 days before the challenge with *Salmonella* sp. (1×10^3 viable bacterial cells) and then throughout the remaining experimental period. The control group (4 mice) was given 200 µl of sterile 0.5 % NaCl solution. All the mice were fed *ad libitum*. On 1st and 14th day after first immunization, treated and control animals were anesthetized and sacrificed by cervical dislocation. The small intestine from each mouse was recovered and its contents were flushed with 1.5 ml PBS.

Statistical methods

A randomized complete block design which incorporated the 4 treatments (control, *L. plantarum* 1K (1K), *L. plantarum* 1K in combination with *Salmonella* sp. (1K + S), and *Salmonella* sp. (S)) and three block trials was used for analysis of the response variables. Analysis of variance of the randomized complete block design was carried out using a general linear model of SAS (1995) where the effect of treatment and replicates were estimated for all response variables. Duncan's multiple comparison test was used as a guide for pair comparisons of the treatment means. Differences between treatments that are described subsequently as being significant were determined at least $P < 0.05$.

Results and Discussion

Consumption of some strains of LAB has been shown to protect animals and human against a wide range of gastrointestinal pathogens (Servin et al., 2003; Servin, 2004, Vinderola et al., 2007). Antagonistic activity of LAB against *Salmonella* sp. has been extensively studied (Cocconnier et al., 2000; Tsai et al., 2005; Vinderola et al., 2007, Golowczyc et al., 2007), however there is a lack of information on the protective effects of LAB against *Salmonella* sp. infection *in vivo*.

The adhesion of *Salmonella* sp. to the surface of epithelial cells represents the first direct contact with host. This is a prerequisite for the subsequent steps in pathogenesis that lead to mucosal infection, systemic spread and disease (Darwin and Miller, 1999). Inhibition of the *Salmonella* sp. invasion into the epithelial cells is the first step forward in the disease prevention. There is an effort to develop alternative strategies for controlling *Salmonella* sp. infections, like possibility to use live, oral biomodulatory agents, such as probiotic LAB.

One of the selection criteria for probiotic strains is to adhere to intestinal tract of the host. Therefore we investigated *in vitro* adhesion of *L. plantarum* 1K on intestinal epithelium cells of mice. *L. plantarum* 1K has shown very good adhesion capability on intestinal epithelium cells of mice (Fig. 1).

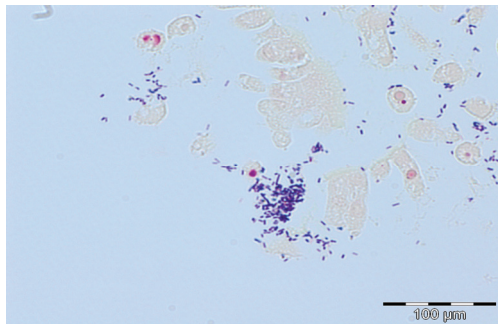

Fig.1. Adhesion of *L. plantarum* 1K to the intestinal epithelium cells of the mouse

Considering that *L. plantarum* 1K fulfilled *in vitro* selection criteria demanded for probiotic strains and exerted inhibitory activity against a wide range of bacteria including some pathogens (results have not shown), therefore, the influence on *Salmonella* sp. infection in Swiss albino mice by treatment with potential probiotic strain *L. plantarum* 1K was studied. The results have shown that the adhesion of *Salmonella* sp. to intestinal epithelial cells of mice was reduced (Tables 1-3). *L. plantarum* 1K survived transit through gastrointestinal tract of mouse and interacted and competed with other microorganisms within the gut environment (Table 1). *L. plantarum* 1K showed better affinity to the large intestine, than to the small intestine epithelial cells of mice (Tables 2-3). Furthermore, the increased number of LAB in small and large intestine was detected 7 days after *L. plantarum* 1K administration, and the number of enterobacteria and *Salmonella* sp. in small and large intestine of mice was lower in comparison to the group of mice infected only with *Salmonella* sp (Tables 2-3). These results could be a consequence of lactic acid and bacteriocin production. Namely, the antibacterial activity of this strain was confirmed *in vitro* against some lactic acid bacteria and some enteropathogenic bacteria including *Salmonella* sp. (results are not shown).

Other authors have also reported that administration of certain strains of LAB can decrease the numbers of faecal *Escherichia coli*, anaerobic cocci and sulphite-reducing clostridia (Lund et al., 2002; Marquina et al., 2002). The possible competitive exclusion mechanisms of probiotic action include ability of probiotic cells to produce antibacterial substances and to compete for nutrients and receptors on the gut enterocytes, but also immune stimulation of the specific and non-specific immune system (Marquina et al., 2002).

The results of this study demonstrated that dietary supplementation with *L. plantarum* 1K can reduce the severity of *Salmonella* sp. infection in mice (Tables 1-3). After oral infection with the pathogen, mice orally treated with probiotic *L. plantarum* 1K exhibited lower cumulative morbidity, but maintained significantly higher feed intake, compared to mice challenged with *Salmonella* sp. alone (results are not shown).

The reduced disease severity conferred by *L. plantarum* 1K in this study against *Salmonella* sp., suggest that dietary supplementation with this defined probiotic strain may represent an effective biotherapeutic means of countering gastrointestinal infection in humans.

Antimicrobial properties of *L. plantarum* 1K and its protection against pathogen infections are of great importance for the application of this strain in fermented dairy products as functional starter culture.

Table 1. Comparison of the total bacterial counts in faeces of mice, fed only with standard rodent feed (control), after the oral treatment of mice with probiotic strain *L. plantarum* 1K (1K), *L. plantarum* 1K in combination with *Salmonella* sp. (1K + S), or after the challenge of mice only with *Salmonella* sp. (S). Total number of bacteria (A) on Peptone yeast extract glucose agar; total lactic acid bacteria (B) on MRS-agar; *Enterobacteriaceae* (C) on Violet Red Bile Glucose agar; *Salmonella* sp. (D) on Brilliant green violet agar.

Growth media	log ₁₀ cfu/g faeces			
	Control	1K	1K + S	S
A	8.26 ± 0.12	8.71 ± 0.15	8.99 ± 0.12*	8.81 ± 0.19*
B	6.95 ± 0.29	10.12 ± 0.23	9.15 ± 0.16	4.11 ± 0.15
C	3.13 ± 0.26	1.78 ± 0.12	4.35 ± 0.12	7.22 ± 0.15
D	-	-	1.01 ± 0.11	3.78 ± 0.12

Mean (± standard deviations) of results from three separate experiments. (-) colonies are not detected. Values marked with asterisks are not significantly different from the control group, according to the student's test (P ≤ 0.01)

Table 2. Bacterial counts in small intestine of mice 7 days after the oral treatment with *L. plantarum* 1K, *L. plantarum* 1K in combination with *Salmonella* sp., or after the challenge with *Salmonella* sp. Total number of bacteria (A) on Peptone yeast extract glucose agar; total LAB (B) on MRS-agar; *Enterobacteriaceae* (C) on Violet red bile glucose agar, *Salmonella* sp. (D) on Brilliant green violet agar.

Growth media	log cfu/g faeces			
	Control	1K	1K + S	S
A	8.11 ± 0.15	8.31 ± 0.15	8.03 ± 0.12*	8.29 ± 0.12*
B	6.45 ± 0.17	9.15 ± 0.13	8.45 ± 0.21	3.89 ± 0.17
C	1.15 ± 0.26	1.78 ± 0.12	3.55 ± 0.15	6.12 ± 0.21
D	-	-	1.15 ± 0.15	3.57 ± 0.21

Mean (± standard deviations) of results from three separate experiments. (-) colonies are not detected. Values marked with asterisks are not significantly different from the control group, according to the student's test (P ≤ 0.01)

Table 3. Bacterial counts in large intestine of mice 7 days after the oral treatment with *L. plantarum* 1K, *L. plantarum* 1K in combination with *Salmonella* sp., or after the challenge with *Salmonella* sp. Total number of bacteria (A) on Peptone yeast extract glucose agar; total LAB (B) on MRS-agar; *Enterobacteriaceae* (C) on Violet red bile glucose agar, *Salmonella* sp. (D) on Brilliant green violet agar.

Growth media	log cfu/g faeces			
	Control	1K	1K + S	S
A	8.35 ± 0.12	8.55 ± 0.31	8.63 ± 0.11*	8.69 ± 0.32*
B	6.78 ± 0.11	9.55 ± 0.23	8.65 ± 0.17	3.76 ± 0.12
C	1.25 ± 0.14	1.56 ± 0.33	3.23 ± 0.11	6.35 ± 0.24
D	-	-	1.03 ± 0.15	3.73 ± 0.12

Mean (± standard deviations) of results from three separate experiments. (-) colonies are not detected. Values marked with asterisks are not significantly different from the control group, according to the student's test (P ≤ 0.01)

Conclusions

L. plantarum 1K survived and adhered to intestinal tract of the mice. Furthermore, *L. plantarum* 1K reduced *salmonella* infection in mice. From these results, we can conclude that the bacterial strain *L. plantarum* 1K isolated from „Slavonski kulen“ could be used as a probiotic strain to establish balance of intestinal microflora because it reduced the growth of undesirable pathogens. Also, research results show that *L. plantarum* 1K, since it is isolated from „Slavonski kulen“, could be used as functional starter cultures for controlled fermentation of meat products, because it inhibits the growth of pathogenic microorganisms, and would thus extend shelf life of meat products.

References

- Coconnier, M.H., Lievin, V., Lorrot, M., Servin, A.L. (2000): Antagonistic activity of *Lactobacillus acidophilus* LB against *Salmonella enterica* serovar *Typhimurium* infecting human enterocyte-like Caco-2/TC-7 cells, *Appl. Environ. Microb.* 66, 1152-1157.
- Darwin, K.H., Miller, V.L. (1999): Molecular basis of the interaction of *Salmonella* with the intestinal mucosa, *Clin. Microbiol. Rev.* 12, 405-428.
- Fontana, C., Cocconcetti, P.S., Vignolo, G. (2005): Monitoring the bacterial population dynamics during fermentation of artisanal Argentinean sausages, *Int. J. Food Microbiol.* 103 (2), 131-142.
- Frece, J. (2007): Synbiotic effect of bacteria: *Lactobacillus acidophilus* M92, *Lactobacillus plantarum* L4 and *Enterococcus faecium* L3, PhD Thesis, Faculty of Food Technology and Biotechnology, University of Zagreb, Croatia.
- Frece, J., Kos, B., Beganović, J., Vuković, S., Šušćković, J. (2005a): *In vivo* testing of functional properties of three selected probiotic strains, *World J. Microb. Biot.* 21, 1401-1408.
- Frece, J., Kos, B., Svetec, I.K., Zgaga, Z., Mrša, V., Šušćković, J. (2005b): Importance of S-layer proteins in probiotic activity of *Lactobacillus acidophilus* M92, *J. Appl. Microbiol.* 98, 285-292.
- Frece, J., Šušćković, J., Kos, B., Beganović, J. (2005c): Immunomodulatory effect of probiotic strain *Lactobacillus acidophilus* M92 in mice. In: Current Studies of Biotechnology IV: Biotechnology and Immuno-Modulatory Drugs, Kniewald, Z. (ed.), pp. 153-165.
- Frece, J., Kos, B., Svetec, I.K., Zgaga, Z., Beganović, J., Leboš, A., Šušćković, J. (2009): Synbiotic effect of *Lactobacillus helveticus* M92 and prebiotics on the intestinal microflora and immune system of mice, *J. Dairy Res.* 76, 98-104.
- Golowczyc, M.A., Mobili, P., Garrote, G.L., Abraham, A.G., De Antoni, G.L. (2007): Protective action of *Lactobacillus kefir* carrying S-layer protein against *Salmonella enterica* serovar Enteridis, *Int. J. Food Microbiol.* 118, 264-273.
- Kos, B., Šušćković, J., Vuković, S., Šimpraga, M., Frece, J., Matošić, S. (2003): Adhesion and aggregation ability of probiotic strain *Lactobacillus acidophilus* M92, *J. Appl. Microbiol.* 94, 981-987.

- Kos, B., Šušković, J., Beganović, J., Gjuračić, K., Frece, J., Iannaccone, C., Canganella, F. (2008): Characterization of the three selected probiotic strains for the application in food industry, *World J. Microb. Biot.* 24, 699-707.
- Kovačević, D. (2001): Kemija i tehnologija mesa i ribe, Sveučilište J.J. Strossmayera, Prehrambeno tehnološki fakultet, PTF Osijek.
- Lund, B., Adamsson, I., Edlund, C. (2002): Gastrointestinal transit survival of an *Enterococcus faecium* probiotic strain administered with or without vancomycin, *Int. J. Food Microbiol.* 77, 109-115.
- Marquina, D., Santos, A., Corpas, I., Munoz, J., Zazo, J., Peinado, J.M. (2002): Dietary influence of kefir on microbial activities in the mouse bowel, *Lett. Appl. Microbiol.* 35, 136-140.
- Matijašić, B., Stojković, S., Rogelj, I. (2006): Survival and in vivo adhesion of human isolates *Lactobacillus gasseri* LF221 and K7 in weaned piglets and their effects on coliforms, clostridia and lactobacilli viable counts in faeces and mucosa, *J. Dairy Res.* 73, 417-422.
- National Research Council (1996): Guide for the care and Use of Laboratory Animals, Institute of Laboratory Animal Resources, National Academy Press, Washington DC.
- Servin, A.L., Coconnier, M.H. (2003): Adhesion of probiotic strains to the intestinal mucosa and interaction with pathogens, *Baillieres Best. Pract. Res. Clin. Gastroenterol.* 17, 741-754.
- Servin, A.L. (2004): Antagonistic activities of lactobacilli and bifidobacteria against microbial pathogens, *Fems Microbiol. Rev.* 28, 405-440.
- Shu, Q., Harsharnjit, S.G. (2002): Immune protection mediated by the probiotic *Lactobacillus rhamnosus* HN001 (DR20) against *Escherichia coli* 0157: H7 infection in mice, *Fems Immunol. Med. Mic.* 34, 59-64.
- Silva, A.M., Barbosa, F.H.F., Duarte, R., Vieira, L.Q., Arantes, R.M.E., Nicoli, J.R. (2004): Effect of *Bifidobacterium longum* ingestion on experimental salmonellosis in mice, *J. Appl. Microbiol.* 97, 29-37.
- Spinler J.K., Taweechotipatr, M., Rognerud, C.L., Oub, C.N., Tumwasorn, S., Versalovic, J. (2008): Human-derived probiotic *Lactobacillus reuteri* demonstrate antimicrobial activities targeting diverse enteric bacterial pathogens, *Anerobe* 14 (3), 166-171.
- Šušković, J., Kos, B., Goreta, J., Matošić, S. (2001): Role of lactic acid bacteria and bifidobacteria in synbiotic effect, *Food Technol. Biotech.* 39, 227-235.
- Tsai, C.C., Hsieh, H.Y., Chiu, H.H., Lai, Y.Y., Liu, J.H., Yu, B., Tsen, H.Y. (2005): Antagonistic activity against *Salmonella* infection in vitro and in vivo for two *Lactobacillus* strains from swine and poultry, *Int. J. Food Microbiol.* 102, 185-194.
- Vinderola, G., Matar, C., Perdigon, G. (2007): Milk fermented by *Lactobacillus helveticus* R389 and its non-bacterial fraction confer enhanced protection against *Salmonella enteridis* serovar *Typhimurium* infection in mice, *Immunobiology* 212, 107-118.

Autochthonous functional starter cultures and mycotoxins in “SLAVONSKI KULEN”

UDC: 637.523 (497.54)

J. Frece^{1*}, K. Markov¹, D. Čvek¹, D. Kovačević²,
L. Duraković¹, F. Delaš¹

¹*University of Zagreb, Faculty of Food Technology and Biotechnology, Laboratory for general microbiology and food microbiology, Pierottijeva 6, 10000 Zagreb, Croatia*

²*University of Josip Juraj Strossmayer in Osijek, Faculty of Food Technology Osijek, Department for food technology, Franje Kuhača 20, 31000 Osijek, Croatia*

Summary

The aim of this work was to investigate possible presence of mycotoxins from “Slavonski kulen”, produced in rural households. The presence of mycotoxins was determined in 6 of 8 analyzed samples. Mycotoxins concentrations were 0.02 to 1.6 ng for ochratoxin A (OTA) and 0.1 to 231 ng for aflatoxin B1 (AFB1) and were defined not only on the surface layer, but also in the centre of “Slavonski kulen”. Also, the microbial population of the traditional “Slavonski kulen” was identified and subjected to technological and functional characterization in order to select potential autochthonous functional starter cultures. Dominant microflora was lactic acid bacteria (LAB), and from the surface 6 of 8 analyzed “Slavonski kulen” were isolated molds from the genera *Penicillium* sp. and *Aspergillus* sp. All lactobacilli isolates produced a significant amount of lactic acid and showed antimicrobial activity against pathogenic test microorganisms.

Keywords: Slavonski kulen, autochthonous microbial populations, starter culture, mycotoxins

Introduction

Aflatoxins are toxic metabolites produced by fungi, e.g., *Aspergillus flavus* and *Aspergillus parasiticus*, growing on cereals, nuts, legumes, fruits and other susceptible crops. The results of their toxicity range from gastroenteritis to cancer. The presence of mycotoxins in food and feed depends on many biological factors, such as region, season, humidity, and temperature, as well as the conditions under which crops are harvested, stored and processed. When not controlled, these toxins can be transferred to animals and humans through the ingestion of contaminated feed and food (Dashti et al., 2009). Endemic nephropathy (EN) is a fatal human kidney disease that occurs in the eastern part of the Croatian Brodsko-posavska County. In the 1970s, the aetiology of the

*.jgoreta@pbf.hr

disease was believed to be related to exposure to mycotoxin ochratoxin A (OTA) (Krogh, 1974). High incidence of otherwise rare urothelial tumours observed later in the same endemic region was also associated with this toxin (Čeović et al., 1991; Miletić-Medvedev, 2005). Studies on laboratory and domestic animals have shown that OTA is nephrotoxic, carcinogenic, genotoxic, and immunotoxic (IPCS, 2001). The International Agency for Research on Cancer (IARC) has classified OTA as Group 2B carcinogens (possible human carcinogen).

There is a wide variety of traditional sausages and meat products in Croatia and the most famous is “Slavonski kulen”. Traditional fermented sausages are manufactured without addition of starter cultures in small-scale processing units. Thus the fermentation of these products only relies on the indigenous microbial flora whose composition is variable and the growth promoted by the environmental conditions (Cocolin et al., 2001). Nowadays, the need for safe products with standard and desirable technological properties has resulted in the use of starter cultures for the production of the dry fermented sausages, to control the fermentation and ripening process, inhibiting the growth of other undesirable microorganisms (Drosinos et al., 2005). Generally, starter cultures consist of lactic acid bacteria, Gram-positive catalase-positive cocci (*Staphylococcus*, *Kocuria*), yeasts and moulds, depending on the sausage type (Drosinos et al., 2007).

Lactic acid bacteria (LAB) play an important role in meat preservation and fermentation processes and are considered technologically fundamental. They are able to decrease pH by lactic acid production, produce bacteriocins to prevent the growth of pathogenic and spoilage microorganisms, provide diversity by the modification of raw material to obtain new sensory properties, improve the safety, the stability and the shelf life of meat products (Fontana et al., 2005; Frece et al., 2005a; Frece et al., 2009) and they also contribute to the development of flavour, colour and texture. Several studies suggested that *Staphylococcus* species, rather than LAB, play an important role in the development of sensory properties (flavour, texture, colour) of fermented sausages by reduction of nitrates, proteolytic and lipolytic activities (Mauriello et al., 2004; Olesen et al., 2004). Moreover, the ability of CNS to produce antimicrobial compounds may improve safety and shelf-life of sausages (Simonova et al., 2006).

The main challenge in developing starter cultures is to improve safety, but also to preserve the typical sensory quality of traditional sausages (Talon et al., 2008). The most promising microorganisms for starter cultures are those which are selected from autochthonous microflora since they are well adapted to the meat environment and to the specific manufacturing process and are capable of dominating the microbiota of the product due to their specific metabolic capabilities.

Nowadays, increasing number of studies is focused on the isolation and identification of autochthonous functional starter cultures, with the aim of

developing new functional meat products, which will be recognized and labelled as autochthonous due to the influence of climate and vegetation of the region in which they are produced (Frece, 2007). Examples include microorganisms that generate aroma compounds, health-promoting molecules, bacteriocins or other antimicrobials, contribute to cured meat colour, possess probiotic qualities, or lack negative properties such as the production of biogenic amines and toxic compounds (Leroy et al., 2006).

The aim of this study was to investigate possible presence of mycotoxins from the “Slavonski kulen”, identify and characterize naturally present microbial population, especially lactic acid bacteria on the basis of their important technological properties in order to select potential autochthonous functional starter cultures.

Materials and Methods

Classical microbiological and biochemical (API) methods for isolation and identification of microorganisms were shown in Table 1.

Table 1. Classical microbiological and biochemical (API) methods for isolation and identification of microorganisms

Microorganisms	Method	Nutrient media	Incubation condition	API test
<i>Staphylococcus</i> spp.	ISO 6888-1:1999 ^a	BP (Merck)	37 °C 48 hours	API STAPH V4.1
Lactic acid bacteria	ISO 13721:1995 ^b	MRS agar (Biolife)	30 °C 48 - 72 hours	API 50 CHL V5.1
Yeasts and moulds	ISO 13681:1995 ^c	Sabouraud agar (Biolife)	25 °C 48 - 72 hours	API 20 C AUX V4.0 Yeasts

^aMicrobiology of food and animal feeding stuffs -- Horizontal method for the enumeration of coagulase-positive staphylococci (*Staphylococcus aureus* and other species) -- Part 1: Technique using Baird-Parker agar medium

^bMeat and meat products -- Enumeration of lactic acid bacteria -- Colony-count technique at 30 degrees C

^cMeat and meat products -- Enumeration of yeasts and moulds -- Colony-count technique

Technological characterization of lactic acid bacteria

Lactic acid bacteria species isolates were subjected to technological characterization.

Effect of NaCl and temperature on microbial growth and proteolytic activity

Effect of 5 % NaCl, temperature (12 °C, 18 °C and 22 °C) and proteolytic activity of LAB species isolates were tested according to Bonomo et al., 2008.

Determination of lactic acid production by HPLC

The ability of lactic acid bacteria to produce lactic acid was measured according to Trontel, et al. (2010) and expressed in g/l.

Sample pretreatment and analysis of glucose and product concentrations in it using high-pressure liquid chromatography (HPLC) was performed as described previously (Trontel et al., 2010). Glucose, lactic acid, acetate and ethanol were obtained from the Sigma-Aldrich (Bellefonte, USA). H₃PO₄ (85 % v/v) (Sigma-Aldrich, Hamburg, Germany) was used to prepare the mobile phase (0.1 % v/v H₃PO₄), and deionized water with conductivity < 1 µS was used to prepare the mobile phase and standard solutions. The experimental set-up consists of a Shimadzu Class-VP LC-10A_{VP} system (Shimadzu, Kyoto, Japan). The piston pump (LC-10AD_{VP}) delivered the mobile phase at 0.5 mL min⁻¹. The substrate and product were separated using a SupelcogelTM C-610H (30cm x 7,8 mm ID, 9µm) analytical column with a SupelcogelTM H (5 cm x 4.6 mm ID, 9 µm) guard column (both supplied by Sigma-Aldrich; Hamburg, Germany), and detected by a refractive index detector (RID-10A).

Antimicrobial activity

Antimicrobial activity of lactic acid bacteria isolates from the “Slavonski kulen” was tested by turbidimetric method (Frece, 2007; Leboš et al., 2008).

The results were expressed as positive (+) on antimicrobial activity if LAB isolates were inhibit the growth of test microorganisms (during 72 hours of cultivation). Test microorganisms used were following: (i) *Staphylococcus aureus* 3048, (ii) *Escherichia coli* 3014, (iii) *Salmonella typhimurium* 3064 and (iv) *Listeria monocytogenes* ATCC 23074 (all from the Collection of microorganisms of Laboratory for General Microbiology and Food Microbiology, Faculty of Food Technology and Biotechnology, University of Zagreb, Croatia). Test microorganisms were grown at 37 °C for 74 h in Nutrient broth (beef extract 3g/l; peptone 5 g/l; Biolife, Milano, Italy).

Sensitivity to oxgall bile

Resistance to bile was tested according to Gilliland and Walker (1990). Brain Heart Infusion broth (BHI, Becton and Dickinson) was prepared by the addition of 1 % (w/v) oxgall (Becton and Dickinson). The volume 50 µl of an 18 h culture of each strain was added to 5 ml of BHI broth with oxgall. After incubation at 37 °C for 24 h, the bacterial growth of strains was measured using a spectrophotometer (Helios ε, “Unicam”, USA) at 600 nm. Numbers of viable cells were estimated at 0 h and after 24 h of incubation on MSA agar (Simonova et al., 2006).

Determination of aflatoxin B1 and ochratoxin A by ELISA (Enzyme Linked immunosorbent assay) method

Aflatoxin B1 was determined using Immunolab Aflatoxin B1 kit, cat. No. AB1-E01, and ochratoxin A using the Neogen kit - Veratox 8610th. The results were reading on a microplate reader (Tecan, Sunrise), at the absorbance of 450 nm for AFB1, and at 650 nm for ochratoxin A.

Statistical analysis

All experiments were carried out in triplicate. The results are expressed as mean \pm S.D. (standard deviation). The SAS statistical computer package was used to analyze the experimental data (SAS Institute, Cary, NC, USA).

Results and discussion

Since on area six of eight samples of “Slavonski kulen” were isolated fungi from the genera *Aspergillus* sp. and *Penicillium* sp. (Table 3), the potential presence of ochratoxin A and aflatoxin B1, were measured by ELISA method (Table 3). Sources of mycotoxins in the samples may be the mold, or spices added to the “Slavonski kulen”. Sampling was conducted according to the Regulation on sampling and analysis methods for official control of the amount of mycotoxins in food (NN 45/08), and samples were taken at a depth of 1 and 2 cm measured from the surface and from the mid of the “Slavonski kulen”, to see how deep mycotoxins can penetrate into the kulen (Table 3). In six of eight samples of the “Slavonski kulen” from which were isolated molds it was proven the presence of AFB1 from 0.1 to 231 ng and ochratoxin A from 0.02 to 1.6 ng. From the results of research, it can be concluded that the isolated *Aspergillus* sp. and *Penicillium* sp. can synthesize mycotoxins, since in the samples from which were not isolated molds, were not detected mycotoxins (Table 3). It is interesting that ochratoxin A was found in the middle of “Slavonski kulen”, while AFB1 was found only on the surface and in a depth of 1 cm. Furthermore, in a sample of “Slavonski kulen” from which were isolated both moulds *Aspergillus* sp. and *Penicillium* sp., it was evidenced lower concentration of ochratoxin A and AFB1, compared to samples from which were isolated pure cultures of moulds (Table 3). This can be explained that the *Penicillium* sp. and *Aspergillus* sp. act antagonistically, inhibiting the growth and production of mycotoxins. Our results are in agreement with the results of other authors (Mandić et al., 2007), who also determine ochratoxin A in the value of 3.8 ng, and AFB1 in the value of 1.33 ng in dry fermented sausages. It should be noted that the permissible amount of ochratoxin A in meat products are not regulated by any legislation at EU level or in Croatia. Classical microbiological and biochemical (API) methods (Table 1) were used for identification of microorganisms isolated from a traditionally

produced “Slavonski kulen”. The results of microbiological analysis showed that the dominant microflora in the samples of the “Slavonski kulen” were lactic acid bacteria (Table 2). Lactic acid bacteria counts were from 3.0 ± 2.1 to $9.23 \pm 1.7 \log_{10}$ CFU/g (Table 2).

Table 2. Technological characteristics of LAB species isolates and some of the selection criteria for starter cultures

Technological characteristics and selection criteria	LAB species				
	<i>L. plantarum</i>	<i>L. delbrueckii</i>	<i>Leuconostoc mesenteroides</i>	<i>L. brevis</i>	<i>Lactococcus lactis</i>
\log_{10} CFU/g samples of “Slavonski kulen”	4.70 ± 1.2	3.0 ± 2.1	9.23 ± 1.7	8.30 ± 1.2	8.0 ± 1.5
Growth in the presence 5 % NaCl	+	+	+	+	+
Growth at 12 °C	+	-	+	+	+
Growth at 18 °C	+	+	+	+	+
Growth at 22 °C	+	+	+	+	+
Proteolytic activity	+	+	+	+	+
Homofermentative species	+	+	-	-	+
Heterofermentative species	-	-	+	+	-
Catalase test	+	+	-	+	+
Concentration of lactic acid (g/l)	21.96 ± 1.1	26.95 ± 0.6	14.76 ± 0.4	16.26 ± 0.3	18.76 ± 0.2
pH of the medium	3.65 ± 1.3	3.25 ± 2.3	3.95 ± 2.5	3.37 ± 2.1	3.45 ± 1.5
\log_{10} CFU/g with 1 % oxgall (viability)	6.3 ± 0.9	5.2 ± 2.3	5.8 ± 1.5	5.02 ± 1.7	5.25 ± 2.2
Antimicrobial activity	+	+	+	+	+

The results of identification showed that dominant LAB species isolated in our study were *Lactobacillus plantarum*, *Leuconostoc mesenteroides*, *Lactobacillus delbrueckii*, *Lactobacillus brevis* and *Lactococcus lactis* (Table 2). Furthermore, the growth rate at different temperatures (2-4 to 24 °C), the tolerance of salt concentrations of 2-10 (max 15) %, and of pH in the range 4.2-6.0 are limiting factors affecting the persistence and competitiveness of the starter culture over the entire fermentation and ripening process (Ammor and Mayo, 2007). Thus, technological characterization; the ability of the isolates to grow at 12, 18 and 22 °C and in the presence of 5 % NaCl was tested (Table 2). In our study, all LAB isolates were shown good technological characteristics, because they able to grow in the presence of 5 % NaCl and at 18 and 22 °C (Table 2). Furthermore, all LAB isolates, except *Lactobacillus acidophilus* 7K2, also grew at 12 °C. Technologically relevant properties such as proteolytic activity of LAB isolates were determined in this study. Lactic acid bacteria usually do not possess strong proteolytic properties, although a degree of peptidase activity has been observed for some meat strains (Leroy et al., 2006). According to the results obtained in this study, all LAB isolates showed proteolytic activity (Table 2). Our study confirmed results of previous study

(Bonomo et al., 2008) reporting that most of lactic acid bacteria (71 %) showed a middle-low proteolytic activity and a small group (29 %) had a higher ability. The results of our study showed that the most of LAB isolates were homofermentative (Table 2), so they do not produce gas from glucose. Heterofermentative LAB are not suitable for sausage production because the formation of large amounts of carbon dioxide leads to holes of different sizes in the product. In addition these LAB produce acetic acid that causes a pungent off-flavour (Ammor and Mayo, 2007). Furthermore, all LAB species isolated in our study, except *Leuconostoc mesenteroides* 6K1, were catalase positive (Table 2). Catalase activity is one of the desired properties for starter cultures used in food fermentation as it can prevent rancidity and colour defects in the products due to the effect of hydrogen peroxide (Lücke, 1985).

The production of lactic acid, which results in a decrease of the pH, contributes to the development of texture, colour and acid taste, prevents the growth of pathogenic and spoilage microorganisms and thus improving safety and stability of the meat products. The ability of LAB isolates to produce lactic acid is shown in Table 2. The results showed that all isolated lactobacilli produced a significant amount of lactic acid between 14.76 ± 0.4 and 26.95 ± 0.6 g/l. The production of lactic acid by LAB isolates resulted in pH reduction in the substrate between 3 and 4. These results are in agreement with the results obtained by Bonomo et al. (2008) who reported that 65 % of LAB strains had good activity, while other strains showed a high acidifying capability with maximum decrease in pH of 2.15. Since one of the most important characteristics of functional starter cultures is inhibition of pathogens, in this paper, antimicrobial activity of the isolated potential starter cultures against pathogenic microorganisms from food was investigated. The presence of the most frequently found pathogens, e.g., *S. aureus*, *L. monocytogenes*, *E. coli* and *Salmonella* spp. can be controlled by a combination of low pH, competitive exclusion with starter cultures and/or bacteriocin production (Frece et al. 2010; Markov et al., 2009; Simonova et al., 2006). The main antimicrobial effect responsible for safety is evidently the rate of acidification of the raw meat (Lücke, 2000). Nevertheless, certain antimicrobials such as bacteriocins may also play a role, in particular in slightly acidified products or to eliminate undesirable microorganisms that display acid tolerance (Leroy et al., 2006). Preliminary study results, obtained by disk-diffusion method, showed that all LAB species displayed high antimicrobial activity against pathogenic test microorganisms and the inhibition zones were from 20 ± 1.7 to 24 ± 2.3 mm (the results not shown). Therefore, the growth of the pathogenic test microorganisms in the presence of the isolates was followed by turbidimetric method. The results obtained by turbidimetric method showed that all LAB isolates displayed significant inhibition of the growth of all investigated pathogenic test microorganisms during 72 hours of cultivation (Table 2). Percentage of growth inhibition of *E. coli*, *S. aureus*, *Salmonella* spp. and *L. monocytogenes* in the presence of LAB isolates after 72 hours was 69.71-85.34 %, 59.29-86.89 %, 74.91-88.59 % and 57.91-82.39 %, respectively (the results not shown).

In order to act as a probiotic in the gastrointestinal tract the bacteria must be able to survive the acidic conditions of the stomach and resist the bile acids at the beginning of the small intestine (Erkkilä and Petäjä, 2000; Frece et al., 2005a; Frece et al., 2009; Frece et al., 2005b). Therefore, we investigated resistance of lactic acid bacteria isolates to 1 % oxgall bile at pH 2.5. The results of our study showed that among LAB isolates *Lactobacillus plantarum* 1K and *Lactobacillus delbrueckii* 2K were particularly resistant to bile since they displayed growth in the presence of 1 % bile at pH 2.5 (Table 2). The results obtained in this study are in agreement with previous studies, which underlined how *Lactobacillus plantarum* isolated from fermented sausages was the most resistant to bile salts (Pennacchia et al., 2004). Moreover, Vinderola and Reinheimer (2003) reported the resistance of commercial and collection probiotic strains of *Lactobacillus delbrueckii* to bile, which is in accordance with the results of our study. In our study, the most sensitive lactobacilli isolates were *Leuconostoc mesenteroides* 6K1 and *Lactobacillus acidophilus* 7K2 since their number was reduced in the presence of 1 % bile at pH 2.5.

Table 3. Concentrations of aflatoxin B1 and ochratoxin A (ng) in samples of “Slavonski kulen”

Samples of “Slavonski kulen” and genera of moulds	Ochratoxin A (ng)	AFB1 (ng)
K1 <i>Penicillium</i> sp. isolated 1 cm deep 2 cm deep center	1.2 ± 1.2 1.0 ± 1.5 1.0 ± 1.4	0.1 ± 0.2 < 0.1 ± 0.2 < 0.1 ± 0.3
K2 <i>Aspergillus</i> sp. isolated 1 cm deep 2 cm deep center	1.49 ± 1.7 1.39 ± 2.2 1.06 ± 1.2	0.3 ± 1.2 < 0.1 ± 0.2 < 0.1 ± 0.2
K3 moulds were not isolated 1 cm deep 2 cm deep center	< 0.05 ± 0.1 < 0.05 ± 0.2 < 0.05 ± 0.2	< 0.1 ± 0.2 < 0.1 ± 0.1 < 0.1 ± 0.2
K4 moulds were not isolated 1 cm deep 2 cm deep center	< 0.05 ± 0.2 < 0.05 ± 0.1 < 0.05 ± 0.2	< 0.1 ± 0.3 < 0.1 ± 0.3 < 0.1 ± 0.2
K5 <i>Aspergillus</i> sp. isolated 1 cm deep 2 cm deep center	1.5 ± 0.2 1.6 ± 1.5 1.5 ± 1.2	0.475 ± 1.2 < 0.1 ± 0.2 < 0.1 ± 0.2
K6 <i>Aspergillus</i> sp. + <i>Penicillium</i> sp. isolated 1 cm deep 2 cm deep center	1.09 ± 0.4 0.94 ± 1.2 0.94 ± 0.7	0.1 ± 1.1 < 0.1 ± 0.2 < 0.1 ± 0.2
K7 <i>Aspergillus</i> sp. isolated 1 cm deep 2 cm deep center	0.02 ± 0.3 0.02 ± 0.5 0.01 ± 0.1	150 ± 2.2 125 ± 3.2 110 ± 1.2
K8 <i>Penicillium</i> sp. isolated 1 cm deep 2 cm deep center	0.4 ± 0.5 0.4 ± 0.2 0.2 ± 0.2	231 ± 1.2 210 ± 1.4 190 ± 1.1

Conclusions

Lactobacillus species isolated in this study could be considered as a potential autochthonous functional starter cultures since they are natural microflora of the “Slavonski kulen” and possess desirable technological and probiotic characteristics regarding the growth capability at different temperatures and salt concentrations, proteolytic activities, production of lactic acid, antimicrobial activity against pathogenic microorganisms and tolerance to bile salts. This work can be considered as preliminary study in developing an autochthonous functional starter culture with the aim of improving safety of the product by inhibiting the growth of undesirable microorganisms and preserving typical sensory quality of the product. Further studies should be carried out to detailed phenotypic, genotypic and physiological characterization of isolated strains of LAB, with the purpose of creating a “bank” of indigenous functional starter cultures for fermented meat products.

References

- Ammor, M.S., Mayo, B. (2007): Selection criteria for lactic acid bacteria to be used as functional starter cultures in dry sausage production: An update, *Meat Sci.* 76, 138-146.
- Bonomo, M.G., Ricciardi, A., Zotta, T., Sico, M.A., Salzano, G. (2009): Technological and safety characterization of coagulase-negative staphylococci from traditionally fermented sausages of Basilicata region (Southern Italy), *Meat Sci.* 83, 15-23.
- Čeović, S., Pleština, R., Miletić-Medved, M., Stavljenić, A., Mitar, J., Vukelić, M. (1991): Epidemiological aspects of Balkan endemic nephropathy in a typical focus in Yugoslavia. In: Mycotoxins, endemic nephropathy and urinary tract tumours, Castegnaro, M., Pleština, R., Dirheimer, G., Chernozemsky, I.N., Bartsch, H. (ed.), Lyon: IARC, pp. 5-10.
- Cocolin, L., Manzano, M., Cantoni, C., Comi, G. (2001): Denaturing gradient gel electrophoresis analysis of the 16S rRNA gene V1 region to monitor dynamic changes in the bacterial population during fermentation of Italian sausages, *Appl. Environ. Microb.* 67, 5113-5121.
- Dashti, B., Al-Hamli, S., Alomirah, H., Al-Zenki, S., Abbas, A.B. Sawaya, W. (2009): Levels of aflatoxin M1 in milk, cheese consumed in Kuwait and occurrence of total aflatoxin in local and imported animal feed, *Food Control* 20, 686-690.
- Drosinos, E.H., Paramithiotis, S., Kolovos, G., Tsikouras, I., Metaxopoulos, I. (2007): Phenotypic and technological diversity of lactic acid bacteria and staphylococci isolated from traditionally fermented sausages in Southern Greece, *Food Microbiol.* 24, 260-270.
- Drosinos, E.H., Mataragas, M., Xiraphi, N., Moschonas, G., Gaitis, F., Metaxopoulos, J., (2005): Characterization of the microbial flora from a traditional Greek fermented sausage, *Meat Sci.* 69, 307-317.
- Erkkilä, S., Petäjä, E. (2000): Screening of commercial meat starter cultures at low pH and in the presence of bile salts for potential probiotic use. *Meat Sci.* 55, 297–300.

- Fontana, C., Cocconcelli, P.S., Vignolo, G. (2005): Monitoring the bacterial population dynamics during fermentation of artisanal Argentinean sausages, *Int. J. Food Microbiol.* 103 (2), 131-142.
- Frece, J. (2007): Synbiotic effect of bacteria: *Lactobacillus acidophilus* M92, *Lactobacillus plantarum* L4 and *Enterococcus faecium* L3, PhD Thesis, Faculty of Food Technology and Biotechnology, University of Zagreb, Croatia.
- Frece, J., Kos, B., Beganović, J., Vuković, S., Šušković, J. (2005a): *In vivo* testing of functional properties of three selected probiotic strains, *World J. Microb. Biot.* 21, 1401-1408.
- Frece, J., Kos, B., Svetec, I.K., Zgaga, Z., Beganović, J., Leboš, A., Šušković, J. (2009): Synbiotic effect of *Lactobacillus helveticus* M92 and prebiotics on the intestinal microflora and immune system of mice, *J. Dairy Res.* 76, 98-104.
- Frece, J., Kos, B., Svetec, I.K., Zgaga, Z., Mrša, V., Šušković, J. (2005b): Importance of S-layer proteins in probiotic activity of *Lactobacillus acidophilus* M92, *J. Appl. Microbiol.* 98, 285-292.
- Frece, J., Markov, K., Čvek, D., Kolarec, K., Delaš, F. (2010): Comparison of conventional and molecular methods for the routine confirmation of *Listeria monocytogenes* in milk products produced domestically in Croatia, *J. Dairy Res.* 77, 112-116.
- Gilliland, S.E., Walker, D.K. (1990): Factors to consider when selecting a culture of *Lactobacillus acidophilus* as a dietary adjunct to produce a hypocholesterolemic effect in humans, *J. Dairy Sci.* 73, 905-911.
- International Programme on Chemical Safety (IPCS). (2001): Safety evaluation of certain mycotoxins in food. WHO Food Additives Series, Vol. 47. Geneva: WHO/FAO.
- Krogh, P. (1972): Mycotoxic porcine nephropathy: a possible model for Balkan endemic nephropathy. In: Endemic Nephropathy, Proceedings of the 2nd International Symposium on Endemic Nephropathy, Puchlev, E. (ed.), Sofia, Bulgaria: Publishing House of Bulgarian Academy of Sciences, pp. 266-270.
- Leboš, A., Habjanič, K., Kos, B., Frece, J., Beganović, J., Šušković, J. (2008): The use of *Lactobacillus plantarum* L4 for the production of probiotic drink with cabbage juice. In Proceedings of the Joint Central European Congress: 4th Central European Congress on Food and 6th Croatian Congress of food technologists, biotechnologist, and nutritionists (CEFood2008), Cavtat, Croatia, pp. 269-276.
- Leroy, F., Verluyten, J., De Vuyst, L. (2006): Functional meat starter cultures for improved sausage fermentation, *Int. J. Food Microbiol.* 106, 270-285.
- Lücke, F.K. (1985): Fermented sausages. In: Microbiology of fermented foods, Wood, B.J.B. (ed.), New York, USA: Elsevier Applied Science, pp. 41-81.
- Lücke, F.K. (2000): Utilization of microbes to process and preserve meat, *Meat Sci.* 56, 105-115.
- Mandić, S., Grujić, R., Topalić-Trivunović, Lj., Radenko, Đ., Stojković, S. (2007): Izvori mikološke i mikotoksikološke kontaminacije dimljenih suvomesnatih proizvoda, *Tehnol. mesa* 48, 157-162.
- Markov, K., Frece, J., Čvek, D., Delaš, F. (2009): *Listeria monocytogenes* and other contaminants in fresh cheese and cream of domestic production from Zagreb area, *Mljekarstvo* 59 (3), 225-231.

- Mauriello, G., Casaburi, A., Blaiotta, G., Villani, F. (2004): Isolation and technological properties of coagulase negative Staphylococci from fermented sausages of southern Italy, *Meat Sci.* 67 (1), 149-158.
- Miletić-Medved, M., Domijan, A.M., Peraica, M. (2005): Recent data on endemic nephropathy and related urothelial tumors in Croatia, *Wien Klin. Wochenschr.* 117, 604-609.
- Olesen, P.T., Meyer, A.S., Stahnke, L.H. (2004): Generation of flavour compounds in fermented sausages – The influence of curing ingredients, *Staphylococcus* starter culture and ripening time, *Meat Sci.* 66, 675-687.
- Pennacchia, C., Ercolini, D., Blaiotta, G., Pepe, O., Mauriello, G., Villani, F. (2004): Selection of *Lactobacillus* strains from fermented sausages for their potential use as probiotics, *Meat Sci.* 67, 309-317.
- Regulation on sampling and analysis methods for official control of the amount of mycotoxins in food, *Narodne novine* 45/08.
- Simonova, M., Stropfova, V., Marcinkova, M., Laukova, A., Vesterlund, S., Moratalla, M.L., Bover-Cid, S., Vidal-Carou, C. (2006): Characterization of *Staphylococcus xylosus* and *Staphylococcus carnosus* isolated from Slovak meat products, *Meat Sci.* 73, 559-564.
- Talon, R., Leroy, S., Lebert, I., Giammarinaro, P., Chacornac, J.P., Latorre-Moratalla, M., Vidal-Carou, C., Zanardi, E., Conter, M., Lebecque, A. (2008): Safety improvement and preservation of typical sensory qualities of traditional dry fermented sausages using autochthonous starter cultures, *Int. J. Food Microbiol.* 126, 227-234.
- Trontel, A., Baršić, V., Slavica, A., Šantek, B., Novak, S. (2010): Modeling the effect of different substrates and temperature on the growth and lactic acid production by *Lactobacillus amylovorus* DSM 20531^T in Batch Process, *Food Technol. Biotech.* in press.
- Vinderola, C.G., Reinheimer, J.A. (2003): Lactic acid starter and probiotic bacteria: a comparative „in vitro“ study of probiotic characteristics and biological barrier resistance, *Food Res. Int.* 36, 895-904.

Bioška vrijednost i kvaliteta ulja masline sorte *Oblica* u odnosu na područje uzgoja

UDC: 665.327.3

M. Gugić^{1*}, I. Jerković², Z. Marijanović¹, M. Šarolić¹

¹Odjel prehrambene tehnologije, Veleučilište “Marko Marulić” u Kninu, Petra Krešimira IV 30, 22300, Knin, Hrvatska

²Zavod za organsku kemiju, Kemijsko-tehnološki fakultet, Sveučilišta u Splitu, Teslina 10/V, 21000 Split, Hrvatska

Sažetak

Provedena su istraživanja kvalitete i bioške vrijednosti ulja masline glavne hrvatske sorte *Oblice* u odnosu na područje uzgoja Sjeverne (okolica Zadra) i Južne (okolica Dubrovnika) Dalmacije. Opće je poznato da kvaliteta i bioška vrijednost djevičanskih maslinovih ulja ovisi o stupnju zrelosti masline, načinu berbe, načinu i vremenu čuvanja do prerade. Kvaliteta i bioška vrijednost djevičanskih maslinovih ulja su definirana na osnovu slijedećih svojstava: omjeru višestruko nezasićenih i zasićenih masnih kiselina, omjeru ω -3 i ω -6 masnih kiselina, omjera polifenola, udjelu sterola, udjelu slobodnih masnih kiselina, peroksidnog broja i organoleptičke ocijene. Indeks zrelosti pogodan za berbu ploda masline postiže se ranije u dubrovačkom području od zadarskog područja. Ulje dobiveno iz zadarskog područja pokazuje manju vrijednost udjela slobodnih masnih kiselina, manji peroksidni broj, vrijednosti polifenola su bile značajno veće, nije pronađena značajna razlika u omjeru ω -3 i ω -6 masnih kiselina, dok kod uzoraka dubrovačkog područja uočena je značajna razlika količine palmetinske kiseline (C 16:0). Osim 2004. godine kod ostalih istraživanih uzoraka organoleptička ocjena pokazala je u korist zadarskog područja. Između svih istraživanih sterola značajna se razlika primjetila kod kolesterola i stigmasterola. U uzorcima zadarskog područja sadržaj ovih dvaju sterola je manji. Dobiveni rezultati su u interakciji s klimatskim parametrima, temperaturom, oborinama i vjetrom te statistički obrađeni s Wilcoxonovim testom ekvivalentnih parova.

Ključne riječi: maslinovo ulje, bioška vrijednost, kvaliteta, *Oblica*, Wilcoxonov test

Uvod

Djevičansko maslinovo ulje je najstarije poznato biljno ulje, jer se može konzumirati izravno nakon izdvajanja nakon ploda, a zbog čega je bilo dugo vremena jedina biljna masnoća. Cijenjeno je po svojoj finoj, uravnoteženoj i jedinstvenoj aromi, okusu i po dugom vremenu skladištenja. Njegovi su bioški, nutritivni i zdravstveni učinci danas stručno i međunarodno priznati. Na kvalitetu i biošku vrijednost maslinovog ulja utječu slijedeći čimbenici:

* mgugic@veleknin.hr

sorta, agrotehnički i elajotehnički zahvati, klimatski uvjeti, zdravstveno stanje ploda, stupanj zrelosti, način berbe i transport plodova, vrijeme čuvanja plodova do prerade i način prerade. Očuvanje kvalitete i biološka vrijednost maslinovog ulja ovisi o vremenu i uvjetima skladištenja ulja. Danas kao parametri kvalitete i biološke vrijednosti maslinovog ulja uzimaju: sastav masnih kiselina, omjer višestruko nezasićenih i zasićenih masnih kiselina, omjer ω -3 i ω -6 masnih kiselina, udjel ukupnih fenola, omjer ukupnih fenola i višestruko nezasićenih masnih kiselina, udjel i sastav sterola, udjel slobodnih masnih kiselina, vrijednost peroksidnog broja i organoleptička ocjena. Djevičansko maslinovo ulje uz visok udjel oleinske kiseine sadrži i višestruko nezasićene esencijalne masne kiseline, linolnu i linolensku. Bitni sastojci maslinovog ulja nalazi se i u neuljnom ili neosapunjivom dijelu kojeg čini oko četrístotine do danas identificiranih spojeva. Ovi spojevi imaju važnu ulogu u brojnim fiziološkim i biokemijskim procesima u našem organizmu. Pored pozitivnog utjecaja na zdravlje potrošača, bitno utječe nas organoleptička svojstva ulja (okus, miris i boja), a uslijed antioksidacijskog djelovanja povećavaju otpornost ulja prema oksidacijskom kvarenju. Među ovim spojevima posebno su bitni antioksidansi, poglavito fenoli, tokoferoli, pigmenti, provitamini i vitamini. Znatno broj radova u kojima kvaliteta maslinovog ulja istražena u odnosu na genetski potencijal sorte, bez praćenja učinka uvjeta u području uzgoja. Tako je i najpoznatija domaća sorta maslina *Oblica* djelomično ispitana na opći genetski potencijal u kontekstu postizanja poznate i priznate kvalitete, odnosno biološke vrijednosti ulja. U posljednje vrijeme posebnu pozornost istraživača koji se bave maslinovim uljem usmjerena je na istraživanje utjecaja interakcije sorte masline i klime područja uzgoja na kvalitetu i biološku vrijednost djevičanskog maslinovog ulja (Kalua i sur., 2006; Laveli i sur., 2006). Svrha ovog rada je istražiti kvalitetu i biološku vrijednost ulja glavne hrvatske sorte masline *Oblice* U odnosu na klimatske uvjete područja uzgoja (sjeverna i južna Dalmacija) svrha ovoga rada bila je istražiti kvalitetu i biološku vrijednost ulja glavne hrvatske sorte masline *Oblice* (u hrvatskom maslinarstvu zastupljena oko 60 %). Kvaliteta i biološka vrijednost djevičanskih maslinovih ulja sorte *Oblica* istovjetnih po stupnju zrelosti plodova maslina, načinu berbe plodova, načinu i vremenu čuvanja plodova od berbe do prerade u ulje, načinu prerade plodova u ulje i čuvanju ulja, proizvedenih od maslina uzgojenih na području južne (okolica Dubrovnika) i sjeverne (okolica Zadra) Dalmacije utvrditi će se na temelju sljedećih svojstava: sastava masnih kiselina, omjera višestruko nezasićenih i zasićenih masnih kiselina, omjera omega-6 i omega-3 masnih kiselina, udjela ukupnih fenola, omjera ukupnih fenola i višestruko nezasićenih masnih kiselina, udjela i sastava sterola, udjela slobodnih masnih kiselina, vrijednosti peroksidnog broja i organoleptička ocjena. Dobiveni rezultati prikazani su u interakciji s klimatskim čimbenicima (temperatura, oborine, insolacija i vjetar) te statistički obrađeni i interpretirani Wilcoxonovim testom ekvivalentnih parova.

Matrijali i metode

Materijali

Uzorci djevičanskog maslinovog ulja sakupljani su tijekom četiri godine: 2003., 2004., 2005. i 2006. godine. Svake godine sakupljeno je po deset paralelnih uzoraka s juga (područje Dubrovnika) i deset sa sjevera Dalmacije (područje Zadra) istih po svim parametrima (sorta, vrijeme berbe, stupanj zrelosti, način berbe, način i čuvanje od berbe do prerade, način prerade i čuvanje ulja). Plodovi maslina su na svim lokacijama brani ručno. Čuvani su u plastičnim gajbama u sloju debljine do 30 cm, i prerađeni najviše 36 sati nakon berbe. Prerada plodova je vršena na suvremenim postrojenjima s mlinovima čekićarima i centrifugalnim dvofaznim dekanterima (horizontalnim separatorima) te separirano na vertikalnom separatoru.

Djevičanska maslinova ulja su nakon prerade u tamnim staklenim bocama dopremljena na analize. Ulja su dobivena od zdravih plodova sorte *Oblica* koji su brani u stupnju zrelosti indeksa od 1 do 3,5 (uziman je uzorak od 100 komada plodova maslina). Paralelni uzorci djevičanskih maslinovih ulja s juga i sjevera Dalmacije brani su u istom stupnju zrelosti, a koji nije bio postignut u istom danu. Režim prerade ovih maslina je bio: broj okretaja u minuti horizontalnog separatora ≈ 3000 , broj okretaja u minuti vertikalnog separatora ≈ 7000 (Škarica i sur., 1996.; Kiritsakis, 1990), vrijeme mjesenja (miješanja) tjesta 30 min, najveća temperatura u procesu prerade 30 °C i kapacitet linije 800 do 1200 kg ploda/sat. Istraživanja su provedena za 2003., 2004., 2005. i 2006. godinu. Svake godine uzeto je 10 paralelnih uzoraka djevičanskih maslinovih ulja. Paralelni uzorak znači: jedan uzorak sa juga i jedan uzorak sa sjevera Dalmacije isti po svim parametrima (sorta, stupanj zrelosti, vrijeme berbe, način berbe, način i čuvanje od berbe do prerade, način prerade i čuvanje ulja). 2003. i 2005. godine paralelni uzorci su ispitivani na SMK, PB i organoleptička obilježja. 2004. godine paralelni uzorci su ispitivani na: SMK, PB, ukupne polifenole i organoleptička obilježja. 2006. godine paralelni uzorci su ispitivani na sve predviđene parametre.

Metode

Određivanje indeksa zrelosti (I_z) (Bakarić, 2000), određivanje slobodnih masnih kiselina (NN 39/99, 1999), određivanje peroksidnog broja (NN/39, 1999), određivanje ukupnih udjela fenolnih spojeva (Pine, 1994), određivanje sastava ukupnih masnih kiselina (ISO 3960, 1990), određivanje sastava i udjela sterola (ISO 3569-2, 1998), senzorska analiza (EEZ) 2568/91, 1991) i Wilcoxonov test ekvivalentnih parova (Petz, 1997)

Rezultati i rasprava

Vrijednosti promatranih klimatskih parametara važnih za ova istraživanja za područje Zadra i Dubrovnika: mjesečne količine oborine, maksimalne dnevne količine oborine, mjesečne temperature zraka, mjesečne maksimalne temperature, mjesečne minimalne temperature, apsolutne maksimalne temperature zraka, apsolutne minimalne temperature zraka, srednje mjesečne sume sijanja sunca, broj oblačnih dana, broj vedrih dana, srednje mjesečne jačine vjetra, broj dana s jakim vjetrom (>od 6 Bf) i broj dana s olujnim vjetrom (>od 8 Bf), za sve navedene parametre provedena je statistička obrada prema Wilcoxonovu testu ekvivalentnih parova. Omjer omega-6 i omega-3 nezasićenih masnih kiselina se uglavnom svodi na vrijednost odnosa linolne i linolenske masne kiseline. Ovaj omjer je također vrlo važan pokazatelj biološke vrijednosti djevičanskog maslinovog ulja. Prema navedenom ne može se utvrditi utjecaj klime na biosintezu ukupnih sterola. Literaturni podaci o utjecaju klime na udjel ukupnih sterola nisu pronađeni. Između svih istraživanih sterola značajna se razlika primijetila kod kolesterola i stigmasterola. Istraživani uzorci zadarskog područja imaju manju količinu ovih dvaju sterola od uzoraka dubrovačkog područja. Neutvrđena statistički značajna razlika organoleptičkih ocjena u ekvivalentnim parovima za 2004. god. možda ima uporište u niskoj statističkoj značajnosti udjela ukupnih fenola u uljima ovih parova. Tvrdnje do kojih se došlo kako područje uzgoja utječe na organoleptičku ocjenu se podudaraju sa literaturnim podacima (Giovacchino i sur., 1980.; Lazzez i sur., 2008.; Ben Temime i sur., 2006.; Deidda i sur., 1994.; Ranalli i sur., 1999). U Tablici 1 su prikazane vrijednosti četverogodišnjeg prosjeka mjesečnih količina oborina koje su statistički obrađene. Rezultati pokazuju statistički značajnu razliku na razini 0,5 % u jednosmjernom testu u korist Dubrovnika. Rečeno je lako uočljivo i sa klima dijagrama po Walteru te sa Slike 1 koja prikazuje godišnje bilance oborina za Zadar i Dubrovnik.

Tablica 1. Mjesečne količine oborine i statistička obrada ekvivalentnih parova Dubrovnika i Zadra za prosjek 2003.-2006. god.

Table 1. Monthly rainfall and statistical analysis of the equivalent pairs of Dubrovnik and Zadar, the average of the years 2003-2006

	Mjesečne količine oborine (mm)- prosjek 2003-2006 god.											
	I	II	III	IV	V	VI	VII	VIII	IX	X	XI	XII
ZADAR	67,53	48,23	56,98	59,00	42,45	28,98	17,73	78,00	57,93	116,75	90,90	95,65
DUBROVNIK	112,08	125,88	107,33	75,18	62,05	91,25	81,40	60,15	102,20	74,55	127,48	151,38
RAZLIKA (DU-ZD)	44,55	77,65	50,35	16,18	19,60	62,28	63,68	-17,85	44,28	-42,20	36,58	55,73
RANG	7	12	8	1	3	10	11	2	6	5	4	9
RANG S PREDZNAKOM	7	12	8	1	3	10	11	-2	6	-5	4	9

Manja suma rangova (T)	7
------------------------	---

Broj parova (N)	12
-----------------	----

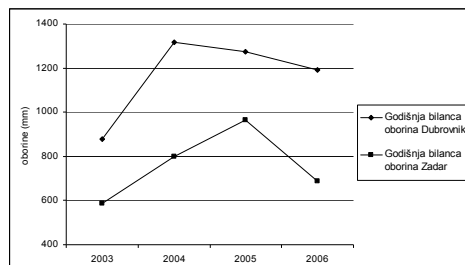

Slika 1. Godišnja bilanca oborina za 2003., 2004., 2005. i 2006. god. u Dubrovniku i Zadru

Fig. 1. The annual balance of rainfall for the years 2003, 2004, 2005 and 2006 in Dubrovnik and Zadar

U Tablici 2 su prikazane vrijednosti četverogodišnjeg prosjeka maksimalnih dnevnih količina oborina po mjesecima, koje su statistički obrađene. Rezultati pokazuju statistički značajnu razliku na razini 2,5 % u jednosmjernom testu u korist Dubrovnika. Rečeno je lako uočljivo i sa Slike 2 koja prikazuje maksimalne dnevne količine oborina po sezonama gdje je vidljivo da je samo u 2005.god. u Zadru bila zabilježena maksimalna dnevna količina oborina neznatno veća nego li u Dubrovniku. Sve ostale praćene godine (2003., 2004. i 2006. god.) pokazuju da je maksimalna dnevna količina oborina bila znatno veća u Dubrovniku nego u Zadru.

Tablica 2. Maksimalne dnevne količine oborine i statistička obrada ekvivalentnih parova Dubrovnika i Zadra za prosjek 2003.-2006. god.

Table 2. Maximum daily rainfall and statistical analysis of the equivalent pairs of Dubrovnik and Zadar, the average of the years 2003-2006

	Maksimalne dnevne količine oborine (mm)- prosjek 2003-2006 god.											
	I	II	III	IV	V	VI	VII	VIII	IX	X	XI	XII
ZADAR	19,40	12,08	23,80	17,78	18,43	16,23	8,73	29,38	28,03	42,35	33,48	30,95
DUBROVNIK	22,48	35,90	27,90	24,93	18,03	38,28	44,23	27,38	35,60	22,10	35,88	48,53
RAZLIKA (DU-ZD)	3,08	23,83	4,10	7,15	-0,40	22,05	35,51	-2,00	7,58	-20,25	2,40	17,58
RANG	4	11	5	6	1	10	12	2	7	9	3	8
RANG S PREDZNAKOM	4	11	5	6	-1	10	12	-2	7	-9	3	8

Manja suma rangova (T) 12

Broj parova (N) 12

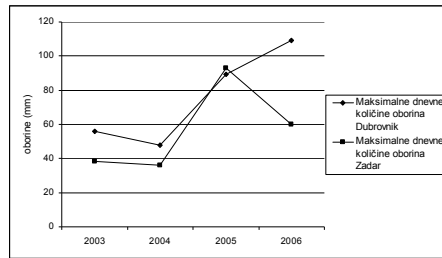

Slika 2. Maksimalna dnevna količina oborina za 2003., 2004., 2005. i 2006. god. u Dubrovniku i Zadru

Fig. 2. Maximum daily rainfall for the years 2003, 2004, 2005 and 2006 in Dubrovnik and Zadar

U Tablici 3 su prikazane vrijednosti četverogodišnjeg prosjeka srednjih mjesečnih temperatura zraka koje su statistički obrađene. Rezultati pokazuju statistički značajnu razliku na razini 0,5 % u jednosmjernom testu u korist Dubrovnika. Navedeno je lako uočljivo i sa klima dijagrama po Walteru te sa Slike 3 koja prikazuje srednje godišnje temperature za Zadar i Dubrovnik.

Tablica 3. Srednje mjesečne temperature zraka i statistička obrada ekvivalentnih parova Dubrovnika i Zadra za prosjek 2003.-2006. god.

Table 3. Average monthly air temperatures and the statistical analysis of the equivalent pairs of Dubrovnik and Zadar, the average of the years 2003-2006

	Srednje mjesečne temperature zraka (°C) - prosjek 2003-2006 god.											
	I	II	III	IV	V	VI	VII	VIII	IX	X	XI	XII
ZADAR	6,50	6,08	8,95	13,48	18,35	22,83	25,33	24,13	20,65	16,78	12,43	9,20
DUBROVNIK	8,68	7,98	10,85	14,53	19,30	23,53	25,78	25,13	22,05	18,30	13,60	11,15
RAZLIKA (DU-ZD)	2,18	1,90	1,90	1,05	0,95	0,70	0,45	1,00	1,40	1,53	1,18	1,95
RANG	12	9,5	9,5	5	3	2	1	4	6	8	7	11
RANG S												
PREDZNAKOM	12	9,5	9,5	5	3	2	1	4	6	8	7	11

Manja suma rangova (T) 0

Broj parova (N) 12

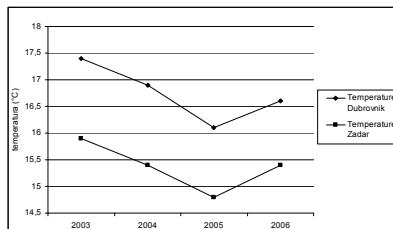

Slika 3. Srednje godišnje temperature zraka za 2003., 2004., 2005. i 2006. god. u Dubrovniku i Zadru

Fig. 3. Average annual temperatures for the years 2003, 2004, 2005 and 2006 in Dubrovnik and Zadar

U Tablici 4 su prikazane vrijednosti četverogodišnjeg prosjeka srednjih maksimalnih mjesečnih temperatura zraka koje su statistički obrađene. Rezultati pokazuju statistički značajnu razliku na razini 0,5 % u jednosmjernom testu u korist Dubrovnika što znači da su u svim mjesecima srednje maksimalne temperature zraka u promatranom razdoblju bile više u Dubrovniku nego u Zadru.

Tablica 4. Srednje mjesečne maksimalne temperature zraka i statistička obrada ekvivalentnih parova Dubrovnika i Zadra za prosjek 2003.-2006. god.

Table 4. Average monthly maximum temperatures and statistical analysis of the equivalent pairs of Dubrovnik and Zadar, the average of the years 2003-2006

	Srednje mjesečne maksimalne temperature zraka (°C)- prosjek 2003-2006 god.											
	I	II	III	IV	V	VI	VII	VIII	IX	X	XI	XII
ZADAR	10,35	10,15	12,95	17,10	22,45	27,00	29,60	28,28	25,05	20,60	16,10	12,68
DUBROVNIK	11,93	11,58	14,53	18,03	23,05	27,20	29,70	29,25	26,53	22,15	17,13	14,40
RAZLIKA (DU-ZD)	1,58	1,43	1,58	0,92	0,60	0,20	0,10	0,98	1,48	1,55	1,03	1,73
RANG	10,5	7	10,5	4	3	2	1	5	8	9	6	12
RANG S PREDZNAKOM	10,5	7	10,5	4	3	2	1	5	8	9	6	12

Manja suma rangova (T)	0	Broj parova (N)	12
------------------------	---	-----------------	----

U Tablici 5 su prikazane vrijednosti četverogodišnjeg prosjeka srednjih minimalnih temperatura zraka koje su statistički obrađene. Rezultati pokazuju statistički značajnu razliku na razini 0,5 % u jednosmjernom testu u korist Dubrovnika što znači da su u svim mjesecima srednje minimalne temperature zraka u promatranom razdoblju bile više u Dubrovniku nego u Zadru.

Tablica 5. Srednje mjesečne minimalne temperature zraka i statistička obrada ekvivalentnih parova Dubrovnika i Zadra za prosjek 2003.-2006. god.

Table 5. Average monthly minimum air temperatures and the statistical analysis of the equivalent pairs of Dubrovnik and Zadar, the average of the years 2003-2006

	Srednje mjesečne minimalne temperature zraka (°C)- prosjek 2003-2006 god.											
	I	II	III	IV	V	VI	VII	VIII	IX	X	XI	XII
ZADAR	3,5	3,0	5,7	10,1	14,5	18,8	16,3	20,4	17,2	13,8	9,6	6,5
DUBROVNIK	6,1	5,2	8,1	11,9	16,3	20,3	22,5	22,1	19,2	15,6	10,9	8,6
RAZLIKA (DU-ZD)	2,6	2,2	2,5	1,9	1,8	1,4	6,2	1,7	2,1	1,9	1,3	2,1
RANG	11	9	10	5,5	4	2	12	3	7,5	5,5	1	7,5
RANG S PREDZNAKOM	11	9	10	5,5	4	2	12	3	7,5	5,5	1	7,5

Manja suma rangova (T)	0	Broj parova (N)	12
------------------------	---	-----------------	----

U Tablici 6 su prikazane vrijednosti četverogodišnjeg prosjeka apsolutnih maksimalnih mjesečnih temperatura zraka koje su statistički obrađene. Rezultati pokazuju statistički značajnu razliku na razini 0,5 % u jednosmjernom testu u

korist Dubrovnik. Navedeno je lako uočljivo i sa Slike 4 koja prikazuje apsolutne maksimalne godišnje temperature za Zadar i Dubrovnik gdje je vidljivo da je u Dubrovniku 2003., 2004. i 2005. god. izmjerena apsolutna maksimalna temperatura viša nego u Zadru. Zadar je postigao višu apsolutnu maksimalnu temperaturu jedino 2006. god.

Tablica 6. Apsolutne maksimalne temperature zraka i statistička obrada ekvivalentnih parova Dubrovnik i Zadra za prosjek 2003.-2006. god.

Table 6. Absolute maximum air temperatures and the statistical analysis of the equivalent pairs of Dubrovnik and Zadar, the average of the years 2003-2006

	Apsolutne maksimalne temperature zraka (°C)- prosjek 2003-2006 god.											
	I	II	III	IV	V	VI	VII	VIII	IX	X	XI	XII
ZADAR	14,9	14,8	19,0	22,2	28,1	32,5	33,4	32,9	29,5	24,5	21,5	16,7
DUBROVNIK	16,6	17,0	19,5	23,1	29,7	33,5	33,9	33,9	30,9	26,1	22,8	19,1
RAZLIKA (DU-ZD)	1,8	2,1	0,5	0,9	1,6	1,0	0,4	0,9	1,3	1,6	1,3	2,4
RANG	10	11	2	3,5	8,5	5	1	3,5	6,5	8,5	6,5	12
RANG S												
PREDZNAKOM	10	11	2	3,5	8,5	5	1	3,5	6,5	8,5	6,5	12

Manja suma rangova (T)	0	Broj parova (N)	12
------------------------	---	-----------------	----

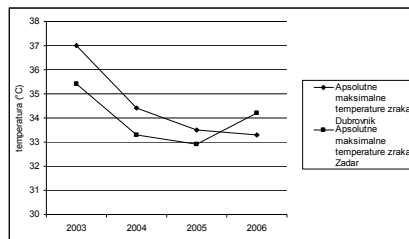

Slika 4. Apsolutne maksimalne temperature zraka za 2003., 2004., 2005. i 2006. god. u Dubrovniku i Zadru

Fig. 4. Absolute maximum air temperatures for the years 2003, 2004, 2005 and 2006 in Dubrovnik and Zadar

U Tablici 7 su prikazane vrijednosti četverogodišnjeg prosjeka apsolutnih minimalnih mjesečnih temperatura zraka koje su statistički obrađene. Rezultati pokazuju statistički značajnu razliku na razini 0,5 % u jednosmjernom testu u korist Dubrovnik.

Tablica 7. Apsolutne minimalne temperature zraka i statistička obrada ekvivalentnih parova Dubrovnika i Zadra za prosjek 2003.-2006. god.

Table 7. Absolute minimum air temperatures and the statistical analysis of the equivalent pairs of Dubrovnik and Zadar for the years 2003-2006

	Apsolutne minimalne temperature zraka (°C) - prosjek 2003-2006 god.											
	I	II	III	IV	V	VI	VII	VIII	IX	X	XI	XII
ZADAR	-2,58	-2,65	-1,28	4,45	10,60	13,73	17,63	16,48	13,40	7,20	3,03	1,10
DUBROVNIK	-0,15	-0,83	0,08	6,33	11,73	13,70	17,75	17,28	14,80	10,03	4,08	3,63
RAZLIKA (DU-ZD)	2,43	1,83	1,35	1,88	1,13	-0,03	0,13	0,80	1,40	2,83	1,05	2,53
RANG	10	8	6	9	4,5	1	4,5	2	7	12	3	11
RANG S												
PREDZNAKOM	10	8	6	9	4,5	-1	4,5	2	7	12	3	11

Manja suma rangova (T)	1	Broj parova (N)	12
------------------------	---	-----------------	----

U Tablici 8 su prikazane vrijednosti četverogodišnjeg prosjeka srednjih mjesečnih suma sisanja sunca koje su statistički obrađene. Manja suma rangova (T) je veća od dozvoljene granice, pa se prema tome ovaj parametar ne može smatrati statistički značajnim. Navedeno je lako uočljivo i sa Slike 5 koja prikazuje da ni godišnje sume sisanja sunca ne pokazuje značajnu razliku.

Tablica 8. Srednje mjesečne sume sisanja sunca i statistička obrada ekvivalentnih parova Dubrovnika i Zadra za prosjek 2003.-2006. god.

Table 8. Average monthly sums of sunshine and statistical analysis of the equivalent pairs of Dubrovnik and Zadar, the average of the years 2003-2006

	Sr. mjesečne sume sisanja sunca - prosjek 2003-2006 god.											
	I	II	III	IV	V	VI	VII	VIII	IX	X	XI	XII
ZADAR	141,9	150,0	199,3	216,4	312,6	334,3	373,4	309,3	256,1	182,8	123,3	118,0
DUBROVNIK	143,4	158,9	189,5	212,4	293,7	315,0	353,1	316,1	254,4	192,7	139,6	125,3
RAZLIKA (DU-ZD)	1,4	8,9	-9,8	-4,1	-18,9	-19,3	-20,3	6,8	-1,7	10,0	16,3	7,3
RANG	1	6	7	3	10	11	12	4	2	8	9	5
RANG S												
PREDZNAKOM	1	6	-7	-3	-10	-11	-12	4	-2	8	9	5

Manja suma rangova (T)	33	Broj parova (N)	12
------------------------	----	-----------------	----

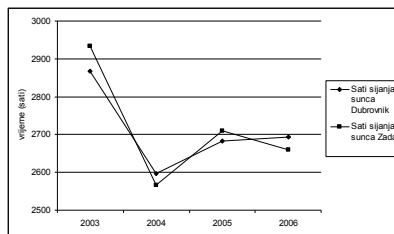

Slika 5. Sati sisanja sunca za 2003., 2004., 2005. i 2006. god. u Dubrovniku i Zadru
Fig. 5. Hours of sunshine in the years 2003, 2004, 2005 and 2006 in Dubrovnik and Zadar

U Tablici 9 su prikazane vrijednosti četverogodišnjeg prosjeka mjesečnog broja oblačnih dana koji su statistički obrađeni. Manja suma rangova (T) je veća od dozvoljene granice pa prema tome ovaj parametar ne možemo smatrati statistički značajnim.

Tablica 9. Broj oblačnih dana i statistička obrada ekvivalentnih parova Dubrovnika i Zadra za prosjek 2003.-2006. god.

Table 9. The number of cloudy days and statistical analysis of the equivalent pairs of Dubrovnik and Zadar, the average of the years 2003-2006

	Broj oblačnih dana - prosjek 2003-2006 god.											
	I	II	III	IV	V	VI	VII	VIII	IX	X	XI	XII
ZADAR	7,0	5,8	6,5	6,8	2,0	2,0	1,5	3,0	3,3	6,5	7,8	8,5
DUBROVNIK	8,0	5,8	9,7	6,5	2,5	3,3	-	1,7	2,8	4,5	6,8	9,5
RAZLIKA (DU-ZD)	1,0	0,0	3,2	-0,3	0,5	1,3	0	-1,3	-0,6	-2,0	-1,0	1,0
RANG	5	0	10	1	2	7,5	0	7,5	3	9	5	5
RANG S												
PREDZNAKOM	5		10	-1	2	7,5		-7,5	-3	-9	-5	5

Manja suma rangova (T)	25,5	Broj parova (N)	10
------------------------	------	-----------------	----

U Tablici 10 su prikazane vrijednosti četverogodišnjeg prosjeka mjesečnog broja vedrih dana koji su statistički obrađeni. Rezultati pokazuju statistički značajnu razliku na razini 0,5 % u jednosmjernom testu u korist Dubrovnika.

Tablica 10. Broj vedrih dana i statistička obrada ekvivalentnih parova Dubrovnika i Zadra za prosjek 2003.-2006. god.

Table 10. The number of sunny days and statistical analysis of the equivalent pairs of Dubrovnik and Zadar, the average of the years 2003-2006

	Broj vedrih dana - prosjek 2003-2006 god.											
	I	II	III	IV	V	VI	VII	VIII	IX	X	XI	XII
ZADAR	8,25	7,25	6,75	6,25	5,25	6,75	13	8,75	11,75	5,5	5,25	6,5
DUBROVNIK	9,5	9,75	7,75	6,25	9,75	14,75	19	18,25	13,5	11,25	8,75	9,5
RAZLIKA (DU-ZD)	1,25	2,5	1	0	4,5	8	6	9,5	1,75	5,75	3,5	3
RANG	2	4	1	0	7	10	9	11	3	8	6	5
RANG S												
PREDZNAKOM	2	4	1	0	7	10	9	11	3	8	6	5

Manja suma rangova (T)	0	Broj parova (N)	11
------------------------	---	-----------------	----

U Tablici 11 su prikazane vrijednosti četverogodišnjeg prosjeka srednjih mjesečnih jačina vjetra koje su statistički obrađene. Manja suma rangova (T) je veća od dozvoljene granice pa prema tome ovaj parametar ne možemo smatrati statistički značajnim. Međutim sa Slike 6, koja prikazuje srednje godišnje jačine vjetra, može se vidjeti da je u Dubrovniku srednja jačina vjetra bila veća nego u Zadru 2004., 2005. i 2006. god. dok je 2003. god. srednja jačina vjetra u Dubrovniku i Zadru bila jednaka.

Tablica 11. Srednje mjesečne jačine vjetra i statistička obrada ekvivalentnih parova Dubrovnika i Zadra za prosjek 2003.-2006. god.

Table 11. Average monthly wind force and the statistical analysis of the equivalent pairs of Dubrovnik and Zadar, the average of the years 2003-2006

	Srednje mjesečne jačine vjetra (Bf)- prosjek 2003-2006 god.											
	I	II	III	IV	V	VI	VII	VIII	IX	X	XI	XII
ZADAR	2,38	2,53	2,33	2,53	2,20	2,23	2,25	2,23	2,18	2,30	2,50	2,53
DUBROVNIK	2,88	2,98	2,73	2,53	2,23	1,88	1,93	2,00	2,35	2,65	2,95	3,13
RAZLIKA (DU-ZD)	0,50	0,45	0,40	0,00	0,02	-0,35	-0,33	-0,23	0,18	0,35	0,45	0,60
RANG	10	8,5	7	0	1	5,5	4	3	2	5,5	8,5	11
RANG S												
PREDZNAKOM	10	8,5	7	0	1	-5,5	-4	-3	2	5,5	8,5	11

Manja suma rangova (T)	0	Broj parova (N)	11
------------------------	---	-----------------	----

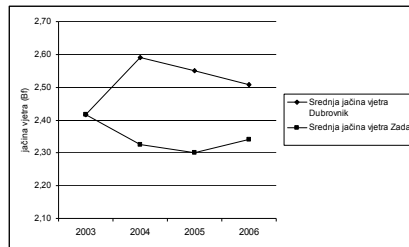

Slika 6. Srednje godišnje jačine vjetra za 2003., 2004., 2005. i 2006. god. u Dubrovniku i Zadru

Fig. 6. Average annual wind force in the years 2003, 2004, 2005 and 2006 in Dubrovnik and Zadar

U Tablici 12 su prikazane vrijednosti četverogodišnjeg prosjeka mjesečnog broja dana s jakim vjetrom (>6 Bf) koji su statistički obrađeni. Rezultati pokazuju statistički značajnu razliku na razini 0,5 % u jednosmjernom testu u korist Dubrovnika.

Tablica 12. Broj dana s jakim vjetrom (>od 6 Bf) i statistička obrada ekvivalentnih parova Dubrovnika i Zadra za prosjek 2003.-2006. god

Table 12. The number of days with strong winds (>of 6 Bf) and statistical analysis of the equivalent pairs of Dubrovnik and Zadar, the average of the years 2003-2006

	Broj dana s jakim vjetrom (>od 6 Bf)- prosjek 2003-2006 god.											
	I	II	III	IV	V	VI	VII	VIII	IX	X	XI	XII
ZADAR	3,00	1,50	3,00	3,25	2,00	0	1,00	2,00	1,50	3,67	3,50	2,75
DUBROVNIK	16,75	15,25	12,25	9,25	10,25	7,75	10,75	9,25	12,75	12,50	13,25	15,25
RAZLIKA (DU-ZD)	13,75	13,75	9,25	6,00	8,25	0	9,75	7,25	11,25	8,83	9,75	12,50
RANG	10,5	10,5	5	1	3	0	6,5	2	9	4	6,5	8
RANG S												
PREDZNAKOM	10,5	10,5	5	1	3	0	6,5	2	9	4	6,5	8

Manja suma rangova (T)	0	Broj parova (N)	11
------------------------	---	-----------------	----

U Tablici 13 su prikazane vrijednosti četverogodišnjeg prosjeka mjesečnog broja dana s olujnim vjetrom (>8 Bf) koji su statistički obrađeni. Rezultati pokazuju statistički značajnu razliku na razini 0,5 % u jednosmjernom testu u korist Dubrovnika. Navedeno je da broj dana s olujnim vjetrom po godinama za Zadar i Dubrovnik gdje je vidljivo da je u Dubrovniku znatno veći broj dana i sa olujnim vjetrom u sve četiri promatrane godine (DHZ, 2006).

Tablica 13. Broj dana s olujnim vjetrom (>od 8 Bf) i statistička obrada ekvivalentnih parova Dubrovnika i Zadra za prosjek 2003.-2006. god.

Table 13. The number of days with stormy winds (> of 8 Bf) and statistical analysis of the equivalent pairs of Dubrovnik and Zadar, the average of the years 2003-2006

	Broj dana s olujnim vjetrom (>od 8 Bf)- prosjek 2003-2006 god.											
	I	II	III	IV	V	VI	VII	VIII	IX	X	XI	XII
ZADAR	0,00	1,00	0,00	0,00	0,00	0,00	0,00	0,00	0,00	0,00	1,00	1,00
DUBROVNIK	5,75	5,67	4,33	1,33	2,00	1,00	0,00	2,00	1,25	1,67	6,50	7,50
RAZLIKA (DU-ZD)	5,75	4,67	4,33	1,33	2,00	1,00	0,00	2,00	1,25	1,67	5,50	6,50
RANG	10	8	7	2	5,5	1	0	5,5	1	3	9	11
RANG S PREDZNAKOM	10	8	7	2	5,5	1	0	5,5	1	3	9	11

Manja suma rangova (T) 0

Broj parova (N) 11

Grafički je prikazana značajnost utjecaja klime na ispitivane parametre kvalitete i biološke vrijednost (Slike 7 do 11).

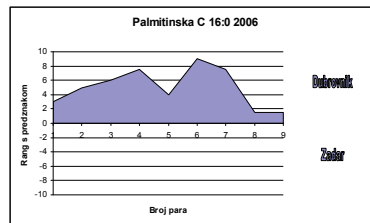

Slika 7. Grafički prikaz statističke obrade vrijednosti palmitinske kiseline ekvivalentnih parova Dubrovnika i Zadra. Razlika među parovima je statistički značajna na razini od 0,5 % u jednosmjernom testu, a 1 % u dvosmjernom testu u korist Dubrovnika

Fig. 7. The graphic presentation of statistical analysis of the values of palmitic acid in the equivalent pairs of Dubrovnik and Zadar. The difference between pairs was statistically significant at the level of 0.5% in the one-way test, and 1% in the two-way test in favor of Dubrovnik

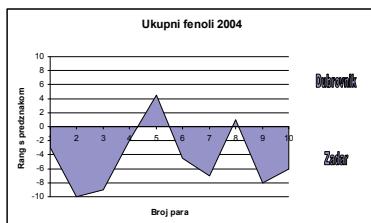

Slika 8. Grafički prikaz statističke obrade vrijednosti ukupnih fenolnih spojeva ekvivalentnih parova Dubrovnika i Zadra. Razlika među parovima je statistički značajna na razini od 2,5 % u jednosmjernom testu, a 5 % u dvosmjernom testu u korist Zadra
Fig. 8. The graphic presentation of statistical analysis of the values of total phenolic compounds in the equivalent pairs of Dubrovnik and Zadar. The difference between pairs was statistically significant at the level of 2.5% in the one-way test, a 5% in the two-way test in favor of Zadar

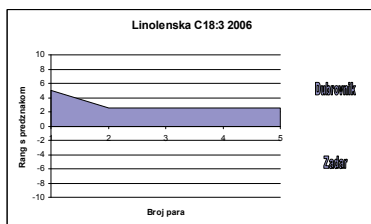

Slika 9. Grafički prikaz statističke obrade vrijednosti linolenske kiseline ekvivalentnih parova Dubrovnika i Zadra. Nije moguće odrediti razinu značajnosti jer je $N < 6$
Fig. 9. The graphic presentation of statistical analysis of the values of linoleic acid in the equivalent pairs of Dubrovnik and Zadar. It is not possible to determine the significance of the difference because the $N < 6$

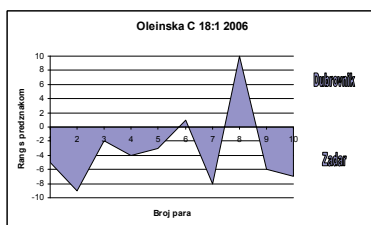

Slika 10. Grafički prikaz statističke obrade vrijednosti oleinske kiseline ekvivalentnih parova Dubrovnika i Zadra. Manja suma rangova (T) je veća od dozvoljene za jednosmjerni i dvosmjerni test pa je prema tome ne možemo smatrati statistički značajnom
Fig. 10. The graphic presentation of statistical analysis of the values of oleic acid in the equivalent pairs of Dubrovnik and Zadar. A smaller sum of ranks (T) is higher than allowed for both the one-way test and the two-way test and, therefore, it cannot be considered as statistically significant

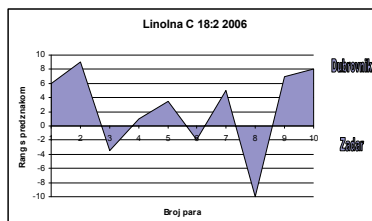

Slika 11. Grafički prikaz statističke obrade vrijednosti linolne kiseline ekvivalentnih parova Dubrovnika i Zadra. Manja suma rangova (T) je veća od dozvoljene za jednosmjerni i dvosmjerni test pa je prema tome ne možemo smatrati statistički značaj **Fig. 11.** The graphic presentation of statistical analysis of the values of linoleic acid in the equivalent pairs of Dubrovnik and Zadar. A smaller sum of ranks (T) is higher than allowed for both the one-way test and the two-way test and, therefore, it cannot be considered as statistically significant

Zaključak

Nedvojbeno je da su se provela znanstvena istraživanja utjecaja klimatskih uvjeta na kvalitetu i biološku vrijednost djevičanskog maslinovog ulja hrvatske autohtone masline sorte *Oblica*. Klima dubrovačkog i zadarskog područja se statistički značajno razlikuje za parametre: mjesečne količine oborine (mm) - prosjek 2003.-2006. godina, količine oborine (mm) - prosjek 2003.-2006. godina, srednje mjesečne temperature zraka (°C) - prosjek 2003.-2006. godina, srednje mjesečne maksimalne temperature zraka (°C) - prosjek 2003.-2006. godina, srednje mjesečne minimalne temperature zraka (°C) - prosjek 2003.-2006. godina, apsolutne maksimalne temperature zraka (°C) - prosjek 2003.-2006. godina, apsolutne minimalne temperature zraka (°C) - prosjek 2003.-2006. godina, broj vedrih dana - prosjek 2003.-2006. godina, broj dana s jakim vjetrom (>od 6 Bf) - prosjek 2003.-2006. godina i broj dana s olujnim vjetrom (>od 8 Bf) - prosjek 2003.-2006. godina. Klima zadarskog i dubrovačkog područja se značajno ne razlikuje za parametre: srednje mjesečne sume sijanja sunca - prosjek 2003.-2006. godina, broj oblačnih dana - prosjek 2003.-2006. godina i srednje mjesečne i godišnje jačine vjetra (Bf) - prosjek 2003.-2006. godina. Klima je utjecala na različitu razinu statističke značajnosti na parametre kvalitete i biološke vrijednosti u promatranom razdoblju na: slobodne masne kiseline 2003. godine, slobodne masne kiseline 2004. godine, slobodne masne kiseline 2005. godine, peroksidni broj 2003. godine, peroksidni broj 2004. godine, peroksidni broj 2005. godine, peroksidni broj 2006. godine, ukupne fenole 2004. godine, ukupne fenole 2006. godine, udjel palmitinske kiseline C 16:0, kolesterol, stigmasterol i ukupni betasitosterol. Klima je vjerojatno utjecala na: organoleptičku ocjenu 2003. godine, organoleptičku ocjenu 2005. godine, organoleptičku ocjenu 2006. godine, udjel linolenske kiseline C 18:3 i sastav

masnih kiselina. Klima nije statistički značajno utjecala na sljedeće parametare kvalitete i biološke vrijednosti: palmitooleinsku kiselinu C 16:1, stearinsku kiselinu C 18:0, oleinsku kiselinu C 18:1, linolnu kiselinu C 18:2, arahinsku kiselinu C 20:0, ukupne sterole, omjer VNMK i ZMK-a, omjer ω -6 i ω -3 masnih kiselina i omjer ukupnih fenola i VNMK-a. Klima je statistički značajno utjecala na: udjel ukupnih fenola, udjel palmitinske kiseline, udjel betasitosterola, udjel stigmasterola. Klima je vjerojatno utjecala na udjel linolenske i sastav masnih kiselina. Klima nije statistički značajno utjecala na: udjel oleinske kiseline, udjel stearinske kiseline, udjel linolne kiseline i udjel ukupnih sterola.

Literatura

- Bakarić, P. (2000): Kada brati masline, Dubrovnik, Hrvatska: Vlastita naklada, str. 10-25.
- Ben Temime, S., Campeol, E., Cioni, P.L., D. Daoud, D., Zarrouk, M. (2006): Volatile compounds from Chétoui olive oil and variations induced by growing area, *Food Chemistry*. 99 (3), 315-325.
- Deidda, P., Nieddu, G., Spano, D., Bandino, G., Orru, V., Solinas, M. (1994): Olive quality in relation to environmental conditions. In: II International Symposium of Olive Growing, ISHS Acta Horticulturae (ed.), Jerusalem, Israel, 354-357.
- Di Giovacchino, L., Fedeli, E., Di Gregorio, P., Solinas, M., Kiritsakis, A.K. (1980): Quality characteristics of olive oil and factors that influence on them proceedings. In: 3th International Congress for Biological Value of olive oil, Elsevier (ed.), Cania, Grece, 545-638.
- DHZ Državni hidrometeorološki zavod (2006): Odjel za pomorsku meteorologiju, Odsjek za pomorska meteorološka motrenja i klimatologiju.
- EEZ 2568/91. (1991): Svojstva ulja od ploda i komine maslina i metodama njihove analize.
- ISO 3960. (1999): Animal and vegetable oils and fats – Analysis by gas chromatography of metil esters of fatty acids.
- ISO 3569-2. (1988): Animal and vegetable oils and fats – Determination of unsaponifiable matter – part 2: Rapid method using hexane extraction.
- Kalua, C.M., Bedgood Jr, D.R., Bishop, A.G., Prenzler, P.D. (2006): Changes in volatile and phenolic compounds with malaxation time and temperature during virgin olive oil Production, *J. Agric. Food Chem.* 54 (20), 7641-7651.
- Kiritsakis, A.K. (1990): Olive oil, American Oil Chemist Society, Illinois, USA: Champaign, 125–138.
- Lavelli, V., Fregapane, G., Salvador, M.D. (2006): Effect of storage on secoindoid and tocopherol contents and antioxidant activity of monovarietal extra virgin olive oils, *J. Agric. Food Chem.* 54 (8), 3002-3007.
- Lazzez, A., Perri, E., Caravita, M.A, Khelif, M., Cossentini, M., (2008): Influence of olive maturity stage and geographical origin on some minor components in virgin olive oil of the chemlali variety, *J. Agric. Food.* 56 (3), 982–988.
- Narodne Novine 39 (1999): Pravilnik o temeljnim zahtjevima za jestiva ulja i masti, margarine i njima slične proizvode, majoneze, umake, preljeve, salate i ostale proizvode na bazi jestivih ulja i masti, Zagreb, Hrvatska: NN 39/99.
- Petz, B. (1997): Osnovne statističke metode za nematematičare III., dopunjeno izdanje, Jastrebarsko, Hrvatska: Naklada Slap (ur.), str. 335-337.

- Pine, S.H. (1994): *Organska kemija*, Zagreb, Hrvatska: Školska knjiga, str. 146-156.
- Ranalli, A., De Mattia, G., Patumi, M., Proietti, P. (1999): Quality of virgin olive oil as influenced by origin area, *Grasasy Aceites* 50 (4), 249-259.
- Škarica, B., Žužić, I., Bonifačić, M. (1996): *Maslina i maslinovo ulje visoke kakvoće u Hrvatskoj*, Novi Vinodolski, Hrvatska: Mario Bonifačić Punat, str. 34-35.

Biological value and quality of olive oil made from the sort *Oblica* in relation to farming area

M. Gugić¹, I. Jerković², Z. Marijanović¹, M. Šarolić¹

¹*Department of Food Technology, Polytechnic Marko Marulić in Knin, Petar Kresimir IV 30, 22300, Knin, Croatia*

²*Department of Organic Chemistry, Faculty of Chemistry and Technology, University of Split, Tesla 10/V, 21000 Split, Croatia*

Summary

A few researches have been conducted on the quality and biological value of the olive oil made from the major Croatian olive sort *Oblica* in relation to the farming area of the North Dalmatia (Zadar area) and South Dalmatia (Dubrovnik area). It is widely known that the quality and biological value of the virgin olive oil depends on the degree of maturity of olives, harvesting methods, manner and time of harvesting, storage and processing of oil, as well as its preservation. Virgin olive oils are defined by the following indicators: the fatty acid composition, the ratio of polyunsaturated and saturated fatty acids, ratio of ω -6 and ω -3 fatty acid, content of polyphenols, ratio of polyphenols and polyunsaturated fatty acid, proportion and composition of sterols, free fatty acid content, peroxide value and organoleptic evaluation. The index of maturity suitable for harvesting olives is achieved earlier in the Dubrovnik area than in the Zadar area. The oil derived from the Zadar area had a smaller proportion of free fatty acids, lower peroxide value, polyphenol values were significantly higher as well as the ratio of polyphenol and polyunsaturated fatty acids, and there has been no significant difference in the ratio of ω -3 and ω -6 fatty acids, while in the Dubrovnik area there has been a significantly higher value of the palmitic acid (C 16:0). All examined samples have shown the benefit of the Zadar area considering the organoleptic evaluation, except for the year 2004. Among all the studied sterols, a significant difference has been noticed in the rates of cholesterol and stigmasterol. The content of these two sterols has been lower in the samples from the Zadar area. The results obtained are in interaction with climatic parameters including temperature, precipitation and wind, and they have been analyzed statistically with the Wilcoxon's test of the equivalent pairs.

Keywords: olive oil, biological value, quality, *Oblica*, Wilcoxon's test

Study on spent brewer's yeast hydrolysis by acid

UDC: 663.479.1

K. Habschied, V. Krstanović*, I. Šimunović, M. Tišma,
V. Slačanac, N. Velić

*University of Josip Juraj Strossmayer in Osijek, Faculty of Food Technology Osijek,
Franje Kuhača 20, 31000 Osijek, Croatia*

Summary

In this study, acid induced autolysis of spent brewer's yeast was carried out with sulfuric (*SA*) and lactic acid (*LA*). The aim of this study was to estimate the success of autolysis induced with inorganic acid compared to autoysis induced with organic acid. The reaction was performed at pH and temperature range which enable the optimum activity of the yeast endoenzymes, so that the process can be considered on acid induced autolysis of yeast biopolymers. Process of hydrolysis was monitored by measuring the increase in the free amino nitrogen (*FAN*, α -amino *N*) concentration. Hydrolysis with sulfuric acid was conducted at the temperature range $T = 45 - 60$ °C, pH 5.0 - 5.4 and in the period of 12 - 32 h. Hydrolyses with lactic acid was carried out at the temperature range $T = 48 - 62$ °C, pH 4.8 - 6.0 and in the period of 12 - 44 h. The best results ($y_{FAN} = 4917.45$ mg/L) obtained with *SA* were at the following process conditions: $T = 52$ °C, pH = 5.2 and $t = 32$ h. On the other hand, the best results ($y_{FAN} = 5789.36$ mg/L) obtained with *LA* were at the $T = 55$ °C, pH = 5.5 and $t = 44$ h. In both performed acid hydrolysis, α -amino *N* content was not detected at temperatures higher than 60 °C, suggesting the possible inactivation of yeast proteases.

Keywords: yeast autolysis induced with acid, free amino nitrogen (*FAN*, α -amino *N*)

Introduction

Brewer's yeast extract production is the usual way of processing spent industrial yeast whose hydrolyzate has a broad application in food industry, microbiology and pharmaceuticals (Baras et al., 1996; Ferreiraa et al., 2010; Chae et al., 2001). Industrial procedures which are used in brewer's yeast extract production are based on transformation of insoluble protein yeast cell components into soluble form that is easier to use. Procedures for brewer's yeast extract include disruption of cell wall using mechanical, chemical or enzyme methods, followed by hydrolysis of intracellular biopolymers (proteins) (Pepler, 1982). Hydrolysis can be carried out by activating endoenzymes of yeast itself or by adding egzoenzymes (protease) or acid. Depending on type of catalysts hydrolysis procedures can be divided into: autolysis (yeast endoenzymes), enzyme hydrolysis (egzoenzymes) and acid hydrolysis

*Vinko.Krstanovic@ptfos.hr

(increase of $[H^+]$ using anorganic acids- HCl and H_2SO_4). Compared to the other two procedures, acid hydrolysis is the oldest procedure and it has substantial number of flaws (increased share of carbohydrates and nucleic acids in hydrolyzate). Obtained hydrolyzate has to be neutralized afterwards. Furthermore, the unfavorable effect of acid hydrolysis is reflected as destructive activity on chemically unstable components of yeast (vitamins and thioamino acids) (Reed and Nagodwithana, 1990). To avoid these disadvantages when using mineral acids, it is recommended to apply pH values that are not destructive to cellular compounds but activate yeast endoenzymes (acid-assisted yeast autolysis). If pH values are set so they ensure optimal conditions for yeast protease activity, this procedure can be called acid-assisted proteolysis. Yeast proteases have different pH and temperature optimum, and it is necessary to adjust these parameters so they provide maximal activity. To adjust pH values for yeast suspensions, mineral, but also organic acids that do not have destructive oxidative activity, can be used. Considering legislative regulations, acetic, citric, formic, gluconic and lactic acid can be used. Lactic acid has a few advantages because it positively affects nutritive and sensory properties of obtained hydrolyzate. Also, after hydrolysis it is not necessary to neutralize and filtrate the hydrolyzate.

Materials and Methods

Brewer's yeast hydrolyzate was obtained from industrial yeast used in "Osječka pivovara d.d.". Washing and debittering of yeast was carried out according to Shotipruk et al. (2005). Yeast was suspended in water and then pH value was adjusted to values shown in Table 1 (autolysis initiated with sulphuric acid) and Table 2 (autolysis initiated with lactic acid). pH range that covers area for yeast endoproteases was chosen according to Baras et al. (1996). Hydrolysis kinetics was monitored by increase of α -amino N (FAN). α -amino N was determined by EBC ninhydrin method that gives values that meet the values of free α -amino N from aminoacids. Ninhydrin is an oxidative chemical that sets off oxidative decarboxilation of aminoacids with separation of CO_2 and NH_3 and aldehyde development which has one C atom less regarding the original aminoacid. Reduced ninhydrine reacts with nonreduced ninhydrin and free NH_3 causing blue coloration (prolyne causes yellow coloration). In this reaction fructose also takes part as a reducer. Sample was heated with ninhydrin at pH 6.7 and the intensity of developed color was measured spectrophotometrically at 570 nm (European Brewery Convention, 1998).

Results and Discussion

Results in Table 1 show α -amino N (FAN) concentrations during hydrolysis with sulphuric acid at different temperatures and pH values. Furthermore, from Table 1 it is visible that the content of FAN is increasing over time of hydrolysis, and reaches saturation limit at higher pH values during the same process time.

Table 1. Content of free amino nitrogen in brewers yeast extract during hydrolisys catalysed by sulphuric acid at the different pH and temperature

		FREE AMINO NITROGEN (mgL ⁻¹)					
Time (h)	pH	temperature (°C)					
		45	47	50	52	55	60
1	5.0	98.74	122.74	178.99	457.64	569.13	778.10
6		1248.33	1344.57	1024.89	1884.65	1104.00	1168.42
12		1989.44	2117.98	2445.51	3753.63	1877.07	1632.01
24		2246.12	2478.88	3124.65	4008.35	1964.56	1897.45
28		2657.66	3398.65	3872.40	4122.06	2963.65	1873.03
32		3078.45	3862.33	4403.11	4536.22	3442.36	2114.31
1	5.2	180.01	167.48	156.40	116.78	137.85	701.53
6		1767.55	2004.31	1827.08	1984.22	3102.04	1263.47
12		2201.36	2941.03	3157.56	2103.65	3433.11	1386.67
24		2869.67	3104.44	3804.74	3642.86	3441.50	1773.21
28		3144.63	3561.97	3894.21	4098.78	3646.55	2047.04
32		3955.67	4126.58	4891.45	4917.45	3714.01	3001.47
1	5.4	100.01	132.66	105.00	131.05	423.28	504.69
6		1869.23	1879.01	2971.58	1463.87	1065.49	699.10
12		2144.50	2604.71	3056.44	2763.46	2498.36	1103.66
24		2687.12	3564.77	3665.01	4131.04	2897.48	1699.58
28		3241.62	3876.58	4201.44	4331.04	3564.74	2130.65
32		3892.06	3964.22	4123.04	4766.34	3688.63	3004.47

Table 2. Content of free amino nitrogen in brewers yeast extract during hydrolisys catalysed by lactic acid at the different pH and temperature

		FREE AMINO NITROGEN (mgL ⁻¹)					
Time (h)	pH	temperature (°C)					
		48	52	55	58	60	62
12	4.8	1145.50	1548.88	1695.44	1006.58	1036.58	964.85
24		1324.58	1669.87	1746.36	1348.22	1102.58	950.69
36		1864.66	2006.58	1936.99	1489.69	1130.25	987.58
40		2214.58	2265.58	2201.63	1569.47	1003.69	992.67
44		2314.25	2445.78	2632.41	1894.22	1233.01	1102.58
12	5.0	2004.65	2678.25	2961.22	2311.58	1142.69	1033.77
24		2164.25	2794.47	3006.84	2744.69	1641.33	1124.69
36		2248.56	3195.47	3101.56	2945.57	1744.25	1421.02
40		2846.95	3045.47	3226.78	3140.01	1747.22	1178.25
44		3301.47	3497.25	3687.56	3457.41	1875.69	1096.14
12	5.3	2897.54	3356.10	3778.55	3210.02	1240.63	1116.44
24		3310.55	3755.24	3938.36	3741.65	1410.23	1332.47
36		3754.69	3849.36	4011.74	4101.34	191810	1632.33
40		3887.26	4221.36	4536.30	4471.63	1663.48	1741.68
44		4132.25	4132.24	4497.33	4689.55	2036.66	2105.64
12	5.5	3134.26	3448.64	4778.03	3174.62	1778.65	1479.36
24		3874.21	4062.41	4897.33	3487.65	2003.33	1648.25
36		4331.10	4513.55	5214.33	3689.14	2213.03	1596.22
40		4013.45	4732.68	5301.56	4665.15	3102.44	1659.47
44		4115.66	4885.36	5789.36	5475.56	3641.54	1874.11
12	6.0	4463.58	4965.47	5264.74	4834.20	3065.47	1687.44
24		4201.39	4623.56	5003.01	4713.54	2697.41	1574.69
36		4174.11	4012.56	5104.56	4544.22	2471.69	1569.23
40		3946.25	4102.36	4633.56	4013.58	2513.03	1466.47
44		3846.22	4236.47	4547.63	4014.62	3847.11	2241.56

Maximum FAN concentration is reached at pH 5.2 and temperature 52 °C over 32 h. This agrees with results obtained by Baras et al. (1996) obtained. However, it should be mentioned that process parameters in this experiment are adjusted according to the latter author, and no research considering pH and temperature range were conducted that would significantly deviate from the values that are represented in Baras's paper. Results in Table 2 represent concentrations of α -amino N (FAN) during hydrolysis with lactic acid at different pH values and temperatures. It is determined that optimal parameters for this process are: pH range 5.3 – 6.0, temperature range 52 - 58 °C, and over time of 40 - 44 h. The best results are obtained at pH 5.5, temperature 55 °C and during 44 h.

Conclusions

Results of brewer's yeast hydrolysis with sulphuric and lactic acid have shown that concentrations of developed FAN is a function of time, temperature and pH values. The best results ($v_{\text{FAN}} = 4917.45$ mg/L) obtained with sulphuric acid were at the following process conditions: $T = 52$ °C, pH = 5.2 and $t = 32$ h. On the other hand, the best results ($v_{\text{FAN}} = 5789.36$ mg/L) obtained with lactic acid were at the $T = 55$ °C, pH = 5.5 and $t = 44$ h. In both performed acid hydrolysis, α - amino N content was not detected at temperatures higher than 60 °C, suggesting the possible inactivation of yeast proteases. Furthermore, it was determined that during hydrolysis with lactic acid similar FAN concentrations were observed as when hydrolysis with sulphuric acid was performed.

References

- Baras, J., Turubatović, L., Maslić, M., Davinić, V. (1996): Kinetics of Brewers Spent Yeast Hydrolysis I. Importance of Hydrolysates and Production Procedures. *Pivarstvo*. 29 (1), 23-29.
- Baras, J., Turubatović, L., Maslić, M., Davinić, V. (1996): Kinetics of Brewers Spent Yeast Hydrolysis II. Brewer's Yeast Hydrolysis by Acid. *Pivarstvo*. 29 (1), 23-29.
- Chae, H.J., Joo, H., In, M.J. (2001): Utilization of brewer's yeast cells for the production of food-grade and protein recovery and flavor characteristics. *Bioresource Technology*. 76, 253–258.
- European Brewery Convention, *Analytica 5. ed.* 1998. Methods 4.10. Fachverlag Hans Carl, D-Nürnberg
- Ferreiraa, I.M.P.L.V.O., Pinhoa, O., Vieiraa, E., Tavela, J.G. (2010): Brewer's *Saccharomyces* yeast biomass: characteristics and potential applications. *Trends in Food Science and Technology*. 21, 77- 84.
- Peppler, H.J. (1982): Yeast extract. In *Economic Microbiology*, ed. Rose A. H., pp. 293-312, vol. 7. London: Academic Press, Inc. ISBN 012-5965557-5
- Reed, G., Nagodwithana, T. (1990): Yeast derived products. In *Yeast Technology*, ed. Reed and Nagodwithana. 369-412 NY, Van Nostrand Reinhold, Inc. ISBN 0-442-31892-8
- Shotipruk, A., Kittianong, P., Suphantharika, M., Muangnapoh, C. (2005): Application of rotary microfiltration in debittering process of spent brewer's yeast. *Bioresource Technology*. 96, 1851–1859.

Chemometric analysis of wheat cultivars

UDC: 633.11 : 543.4

D. Horvat^{1*}, Ž. Kurtanjek², G. Drezner¹, G. Šimić¹

¹*Agricultural Institute Osijek, Južno predgrađe 17, 31000 Osijek, Croatia*

²*University of Zagreb, Faculty of Food Technology and Biotechnology, Pierottijeva 6, 10000, Zagreb, Croatia*

Summary

In this work applied is chemometric analysis for classification and modeling of 28 domestic and foreign wheat cultivars from 2007 year of production. The analysis is aimed for investigation of genetic divergence of cultivars and determination of effects of gliadin fractions and HMW glutenin subunits on technical quality parameters. For each cultivar are determined the following 35 parameters: genotypes, composition and mass fractions of gliadin fractions determined by RP-HPLC method, composition of HMW glutenin subunits (HMW-GS) determined by SDS-PAGE electrophoresis and indirect and rheological quality parameters. Since single parameter analysis does not reveal the complexity of interaction on quality applied is the multivariate approach. Samples of cultivars are projected from 35 dimension of the parameter space to the 5 dimensional space of principal components (PCA) by which 95 % of the original data variability is retained (correspond to the level of accuracy). Cluster analysis of the cultivars is based on the PCA projections. Input-output linear models are derived from the projections, by the method of partial least squares (PLS), for prediction of wheat technological quality parameters (outputs) from projections of genotype and biochemical data (inputs). The obtained chemometric models are viewed as a potential for rational selection of wheat cultivars based on statistical multivariate data and derived predictive models.

Keywords: wheat, gliadins, HMW glutenin subunits, PCA, PLS

Introduction

From production in 2007 analyzed are the following 28 domestic and foreign wheat cultivars: Alka, Bezostaya-1, Edison, Flori2, Golubica, Demetra, Divana, Lupus, Lucija, Renan, Pipi, Prima, Super žitarka, Srpanjka, Zlatna dolina, Žitarka, Janica, Ilirija, Mihaela, Felix, Ficko, Osk. 310/06, Sana, Seka, Soissons, U1, Ružica, Panonka. The goal of the analysis is investigation of genetic divergence of the cultivars, analysis of the differences between genotypes of the foreign and domestic cultivars, with the focus on determination of effects of gliadin fractions and high molecular weight (HMW) glutenin subunits (HMW-GS), determined by SDS-PAGE electrophoresis, on wheat indirect quality parameters and dough rheological properties. All experimental data are treated

* daniela.horvat@poljoinos.hr

as a single structured matrix. The complete data X(28,32) block is structured in the matrices with HPLC gliadins (HPLC), HMW-GS (HMW), indirect quality (Q) and rheological properties (R) with corresponding dimensions: XHPLC(28,15), XHMW(28,4), XQ(28,4), XR(28,13). Structure of the data sets and their interrelationships are determined by multivariate methods, based on principal component analysis (PCA), and the functional relationship between technical quality and molecular properties by multivariate partial least squares (PLS).

Methods and results

Due to different experimental methods and measurement units the variables, corresponding to the matrix columns, are firstly autoscaled in order to enable unbiased quantitative comparison and statistical evaluation. For each experimentally determined *i*-th variable, X_i , are calculated average values \bar{X}_i and corresponding standard deviations σ_i . The original variables are transformed by the following relationships:

$$X_{HPLC(i,j)} \leftarrow \frac{X_{HPLC(i,j)} - \bar{X}_{HPLC,i}}{\sigma_{HPLC,i}} \quad (1)$$

$$X_{HMW(i,j)} \leftarrow \frac{X_{HMW(i,j)} - \bar{X}_{HMW,i}}{\sigma_{HMW,i}} \quad (2)$$

$$X_{Q(i,j)} \leftarrow \frac{X_{Q(i,j)} - \bar{X}_{Q,i}}{\sigma_{Q,i}} \quad (3)$$

$$X_{R(i,j)} \leftarrow \frac{X_{R(i,j)} - \bar{X}_{R,i}}{\sigma_{R,i}} \quad (4)$$

To obtain the basic insight into statistical properties of the data, for each subclass of experimental methods, evaluated are histograms presented in Fig. 1. For the autoscaled data investigated are, in view of multivariate analysis, assumptions on normal distributions, multimodal effects, and presence of distribution tails. The obtained distributions show that only gliadins characterized by RP-HPLC and indirect quality data are approximately distributed as normal distributions.

However, the PDF distribution of HMW-GS data shows multimodal character and a very distinct presence of the right hand (large values) tail data.

Topic: Food technology and biotechnology

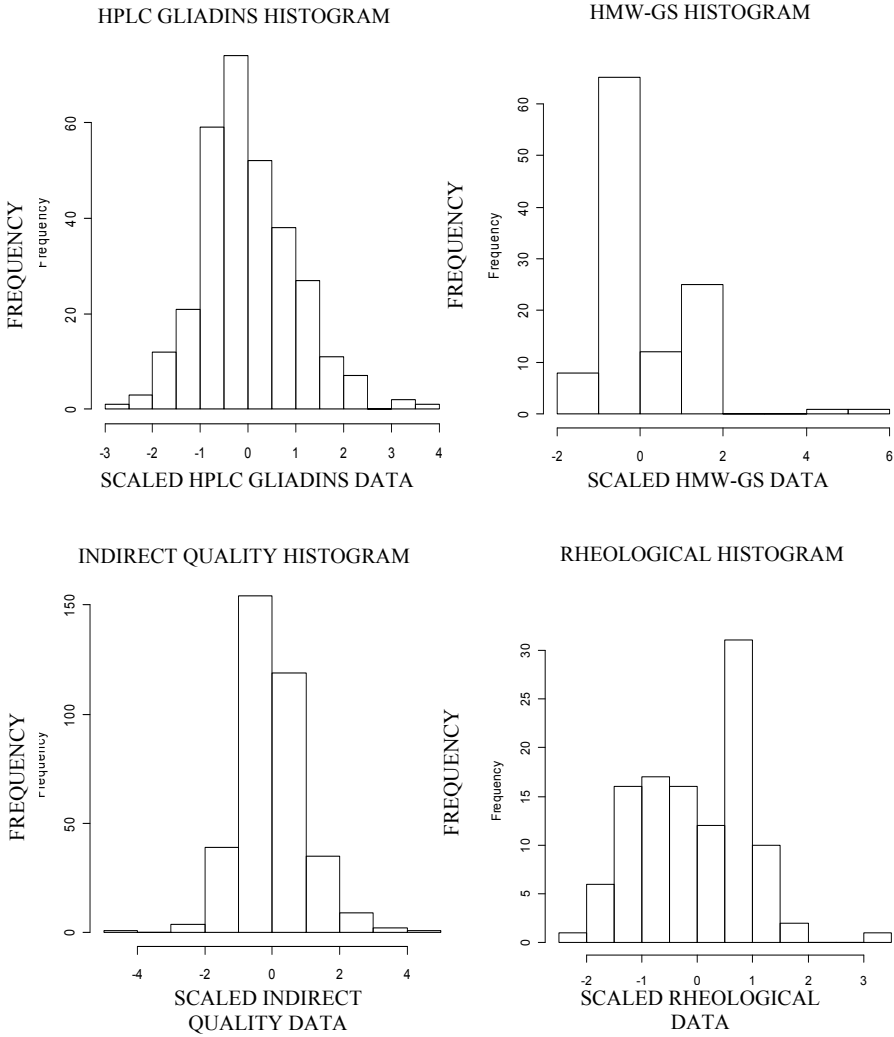

Fig. 1. Histograms of scaled HPLC gliadins, HMW-GS, indirect quality and rheological data

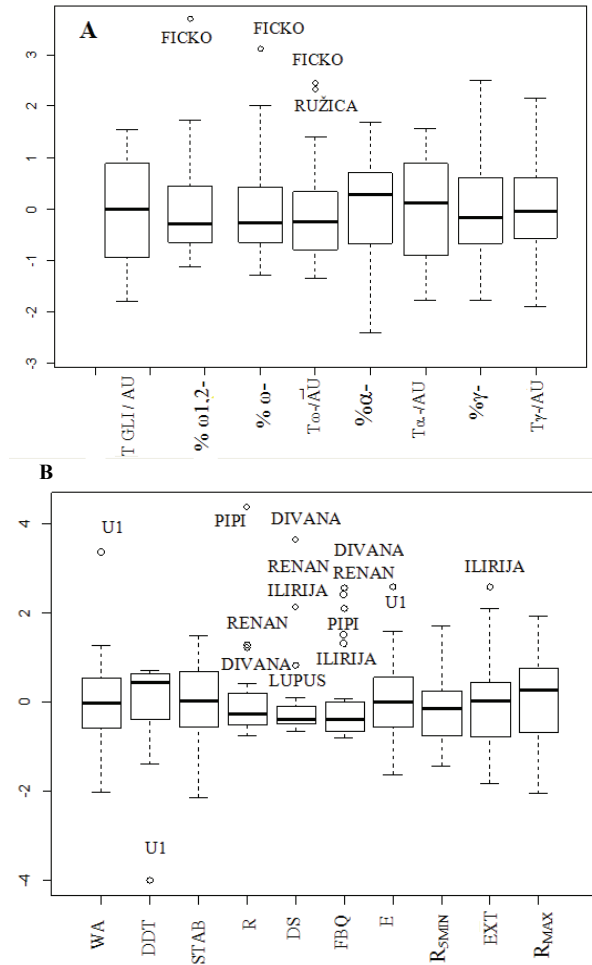

Fig. 2. Box plots of quantile (25 %) distributions of HPLC gliadins (A) and rheological (B) data with detection of the cultivar statistical “whiskers”

Similarly, the bimodal character is obtained for the rheological data, also with an isolated right-hand tail. These distributions indicate statistically important clustering of the cultivars based on HMW-GS and rheological properties.

In order to investigate for each individual experimental variable empirical probability density function distributions (PDF) evaluated are quantiles which divide the data population of each variable into four equal classes with probabilities $p = 0.25$, presented as box plots in Fig. 2-3. On the same graphs are also depicted medians as robust estimates of averages, and specific cultivars as statistical “whiskers” which are statistical significantly from corresponding

distributions. From sizes of each quantile box can be observed skewing as distortion of empirical PDFs from normality. Cultivars which have individual properties significantly outside the expected quantile ranges are presented as isolated circles. The box plots for HMW-GS and indirect quality properties show the most deviation from statistical normality. The most statistically unexplained properties, presented as isolated whiskers, are for HPLC property %ω5-, farinographic FBQ, HMW-GS are Glu-B1, Glu-D1 and WG for quality properties.

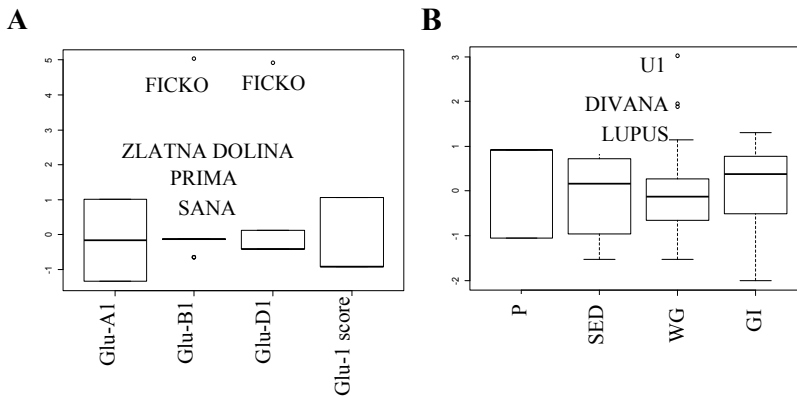

Fig. 3. Box plots of quantile distributions (25 %) of HMW-GS (A) and indirect quality data (B) with detection of the statistical “whiskers” of the cultivars

Due to large number of variables and their complex interaction, multivariate approach is applied for investigation of data structures and their interrelations. For each group of experimental data are evaluated latent variables P and scores T for each cultivar:

$$\mathbf{T}_{HPLC} = \mathbf{X}_{HPLC} \cdot \mathbf{P}_{HPLC} \quad (5)$$

$$\mathbf{T}_{HMW} = \mathbf{X}_{HMW} \cdot \mathbf{P}_{HMW} \quad (6)$$

$$\mathbf{T}_R = \mathbf{X}_R \cdot \mathbf{P}_R \quad (7)$$

$$\mathbf{T}_Q = \mathbf{X}_Q \cdot \mathbf{P}_Q \quad (8)$$

Errors E resulting from reduction of the variable space to low dimension of loading variables is given by:

$$\mathbf{X}_{HPLC} = \mathbf{T}_{HPLC} \cdot \mathbf{P}_{HPLC}^T + \mathbf{E}_{HPLC} \quad (9)$$

$$\mathbf{X}_{HMW} = \mathbf{T}_{HMW} \cdot \mathbf{P}_{HMW}^T + \mathbf{E}_{HMW} \quad (10)$$

$$\mathbf{X}_R = \mathbf{T}_R \cdot \mathbf{P}_R^T + \mathbf{E}_R \quad (11)$$

$$\mathbf{X}_Q = \mathbf{T}_Q \cdot \mathbf{P}_Q^T + \mathbf{E}_Q \quad (12)$$

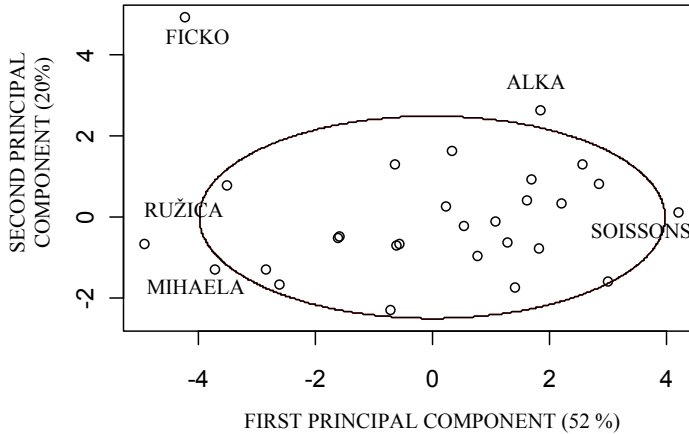

Fig. 4. Projections of the cultivars on the plane of the first two principal components of HPLC gliadins data. The outliers are determined by Mahalanobis distance measure with 75 % probability

From the scree plots of the variance distributions is revealed that 3 principal components account for about 85 % of the total data dispersions for each individual group of data. The cultivar projections on the plane of the first two principal components of HPLC gliadins data are shown in Fig. 4. Here is applied the concept of Mahalanobis distance (Eq. 13) for detection of multivariate cultivar outliers. The distance between two cultivars A and B is defined by:

$$d(\text{Mahalanobis}) = [(\mathbf{X}_A - \mathbf{X}_B)^T \cdot C_{AB}^{-1} \cdot (\mathbf{X}_A - \mathbf{X}_B)]^{1/2} \quad (13)$$

The distance is evaluated in the principal component plane and is weighted with the inverse of the sample covariance between the two objects:

$$C_{AB} = \frac{1}{n-1} \cdot (\mathbf{X}_A - \mathbf{1} \cdot \bar{X}_A)^T \cdot (\mathbf{X}_B - \mathbf{1} \cdot \bar{X}_B) \quad (14)$$

The Mahalanobis distances are distributed by $\chi^2(n-1)$ distribution which enables probabilistic determination of multivariate outliers. In Fig. 4 is depicted the ellipsoid with 75 % probability limit which discriminates five cultivars as outliers, with Ficko being the most diverse (distant) in the set of HPLC gliadins data.

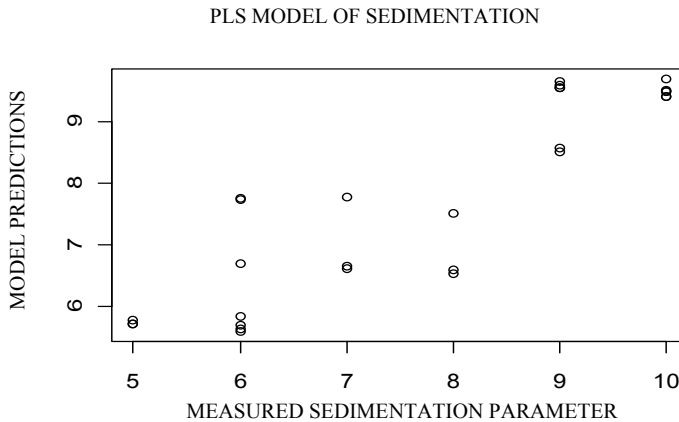

Fig. 5. Partial least squares (PLS) model for prediction and cross validation of sedimentation parameter on the first two principal components of high molecular mass (HMW) data

Partial least squares models are developed for prediction of quality and rheological properties based on multivariate analysis of HPLC and HMW –GS data. The main assumption is that rheological dough properties and indirect quality parameters can be predicted from measurements of molecular compositions. Each single property is considered as output variable y predictable from HPLC and HMW data X by linear models:

$$y = X_{HPLC} \cdot b_{HPLC} + b_{HPLC,0} \quad (15)$$

$$y = X_{HMW} \cdot b_{HMW} + b_{HMW,0} \quad (16)$$

The model parameters b is regression parameters on scores of data matrices in principal component space. In PLS model the principal components are determined from the criteria of maximisation of covariance of the output variable and the scores T . The predictive accuracy of the models is tested by cross validation (CV) method. As an example of the models, predictive of sedimentation value parameter from HMW data is presented in Fig. 5. Errors of the proposed model are observable from dispersion of predictions obtained by cross validation.

Conclusions

Applied are chemometric methods for evaluation of effects of genetic divergence on indirect quality parameters and dough rheological properties of Croatian (Osijek) selected and a number of international wheat cultivars. Due to

large number of HPLC gliadins and HMW-GS data the multivariate concept based on data grouping is emphasized.

Empirical probability distributions are inferred from histograms of auto-scaled data groups. The main conclusion is that HPLC gliadins and HMW-GS data are distributed approximately by normal distributions. However, the data for indirect quality parameters and rheological dough properties show multimodal distributions with pronounced tailed data. These observations imply important nonlinear interrelationship between wheat cultivar properties and their molecular data.

Detailed information on probability distribution functions for each measured variable is obtained by quantile graphical presentation (box plot). Based on the box plots determined are number of cultivars as statistical whiskers, indicating possible experimental outliers or distinguished properties.

The multivariable cultivar clustering and detection of outliers are determined by principal component analysis for each group of data. The data projection is effective, with average 85 % variance explained by the first three components. The outliers of cultivars are determined by use of Mahalanobis measure of distance and χ^2 distribution with level of 75 % probability.

Applicability of the chemometric results are demonstrated by development of linear PLS models of indirect physical properties and technical quality on molecular data (HPLC gliadins and HMW-GS). Accuracy of predictive of the proposed models is evaluated by cross-validation procedure.

The main advantage of the proposed multivariate analysis of molecular data and physical and technological properties is in ability of the models for prediction complex properties from molecular data and leading in rational improvement of future wheat cultivar selection.

References

- Horvat D., Jurković Z., Sudar R., Pavlinić D., Šimić G., (2002): The relative amounts of HMW glutenin subunits of OS wheat cultivars in relation to bread-making quality, *Cereal Res. Commun.* 30, 415–422.
- Horvat D., Kurtanjek Ž., Drezner G., Šimić G., Magdić D., (2009): Effect of HMM Glutenin Subunits on Wheat Quality Attributes, *Food Technol. Biotechnol.* 47 (3), 253-259.
- Jurković Z., Sudar R., Drezner G., Horvat D., (2000): The HMW glutenin subunit composition of OS wheat cultivars and their relationship with bread-making quality, *Cereal Res. Commun.* 28, 271–277.
- Kurtanjek, Ž., Horvat D., Magdić D., Drezner G. (2008): Factor Analysis and Modelling for Rapid Quality Assessment of Croatian Wheat Cultivars with Different Gluten Characteristics, *Food Technol. Biotechnol.* 46 (3), 270-277.
- R, Development Core Team (2009). R: A language and environment for statistical computing. R Foundation for Statistical Computing, Vienna, Austria.
- Statistica* (2009), StatSoft Inc. Tulsa, OK, USA. v. 8.0.
- Varmuza, K., Filmoser, P. (2009): *Multivariate Statistical Analysis in Chemometrics*, CRC Press, Boca Rato, USA.

The influence of interactions among phenolic compounds from chokeberry on the antiradical activity of chokeberry

UDC: 634.7 : 547.56

L. Jakobek*, M. Šeruga, P. Krivak

University of Josip Juraj Strossmayer in Osijek, Faculty of Food Technology Osijek, Franje Kuhača 20, HR 31000 Osijek, Croatia

Summary

In this work, interactions between chokeberry (*Aronia melanocarpa*) phenols and their influence on the antiradical activity were studied. Three fractions were extracted from chokeberries. Every fraction was enriched with different classes of phenolic compounds, first with flavonols and hydroxycinnamic acids, the second with anthocyanins and the third with insoluble phenols and proanthocyanidins. Antiradical activities of phenolic fractions and their mixtures were determined by using the DPPH test. Results showed that the reaction between phenols and DPPH^{*} radicals was a biphasic reaction with “fast” and “slow” scavenging rates. Phenolic mixtures showed lower antiradical activity in comparison to the antiradical activity of individual fractions which can be the result of various interactions between phenolic compounds. This suggests that interactions among phenols promoted a negative synergistic effect on the antiradical activity of chokeberries.

Keywords: phenolic compounds, antiradical activity, chokeberry, interactions, synergism

Introduction

Aronia berries (*Aronia melanocarpa*), commonly known as black chokeberries, are a member of Rosaceae family (Kulling and Rawel, 2008). Many studies have demonstrated the potential positive effects of chokeberries or their phenolic components on the human health. These include antioxidant effect (Kulling and Rawel, 2008; Wu et al., 2004), the inhibition of cancer cell proliferation, antimutagenic effects, cardioprotective effects, antidiabetes effects (Kulling and Rawel, 2008, Bermudez-Soto et al., 2007a; Bermudez-Soto et al., 2007b; Jurgonski et al., 2008). The antiradical activity or ability to scavenge free radicals has an important role in beneficial effects of chokeberry phenols on the human health and is an important characteristic of phenolic compounds. Chokeberry phenols showed stronger antiradical activity than other fruits and berries (Wu et al., 2004) which makes these berries interesting for various investigations.

A series of papers investigated the antiradical activity of fruits (Kulling and Rawel, 2008; Wu et al., 2004.; Zheng et al., 2003; Määttä-Riihinen et al., 2005).

* lidija.jakobek@ptfos.hr

But very little is known about interactions that can occur between phenolic compounds or between other fruit components, and the effects of these interactions on the antiradical activity of fruits. Some studies have shown that interactions among different compounds and among phenols itself can promote changes in the antiradical capacity of fruits (Pinelo et al., 2004). Interactions can lead to synergistic effects, negative synergism and additive effect (Pinelo et al., 2004).

The aim of this work was to study the antiradical activity of phenolic compounds from chokeberries, interactions among them and their influence on the total antiradical activity of chokeberries. Phenols were separated into three fractions. The first fraction was enriched with hydroxycinnamic acids, flavonol glycosides, the second with anthocyanins, and the third with insoluble phenols and high molecular weight (HMW) proanthocyanidins. The antiradical activity of fractions was studied by using the DPPH test. Fractions were then mixed and the antiradical activity of mixtures was evaluated and compared to the trend followed by each phenol fraction.

Materials and methods

Chokeberry samples

Black chokeberries (*Aronia melanocarpa*) were harvested at maturity in Slavonia (Croatia) in 2009. Immediately after harvesting, fruits were frozen and stored at $-20\text{ }^{\circ}\text{C}$ until analysis.

Extraction of phenolic fractions

The extraction was carried out by procedure already described in the literature (Määttä-Riihinen et al. 2004a; Määttä-Riihinen et al. 2004b). The frozen berries were homogenized, weighed ($\sim 10\text{ g}$), and extracted with ethyl acetate ($4 \times 20\text{ ml}$). The combined ethyl acetate extracts contained free and conjugated hydroxycinnamic acids, flavonol glycosides. An aliquot of ethyl acetate extract (50 ml) was evaporated to dryness ($35\text{ }^{\circ}\text{C}$) using a rotary evaporator and dissolved in 4 ml of methanol (fraction 1).

The remaining berry residue (after ethyl acetate extraction) was acidified with HCl (2 mol dm^{-3} , 4 ml) and extracted with methanol ($4 \times 25\text{ ml}$). The combined extracts contained anthocyanins in the form of flavylium cations. An aliquot of the methanol extract (40 ml) was evaporated to dryness, dissolved in 5 ml of methanol (fraction 2).

The berry residue remaining after anthocyanin extraction was suspended in 20 ml of methanol, acidified to 0.6 mol dm^{-3} with concentrated HCl, and refluxed for 2 h ($60\text{ to }70\text{ }^{\circ}\text{C}$) (fraction 3). This extract contained insoluble glycosidic forms of hydroxycinnamic acids and flavonols and HMW proanthocyanidins.

Proanthocyanidins were converted to anthocyanidins under the conditions in reflux procedure.

Fractions were directly used in the HPLC analysis and in the antiradical activity determinations.

High performance liquid chromatography

Main phenolic compounds in fractions were identified by using the high performance liquid chromatography (HPLC) with photo diode array detection (PDA). The instrument was Varian HPLC system (USA) consisting of ProStar 230 solvent delivery module, ProStar 330 PDA detector and OmniSpher C18 column (250 x 4.6 mm inner diameter, 5 μm , Varian, USA).

The flavonols and phenolic acids were separated using 0.1 % phosphoric acid as solvent A and 100 % HPLC grade methanol as solvent B (elution conditions: 0-30 min from 5 % B to 80 % B; 30-33 min 80 % B; 33-35 min from 80 % B to 5 % B; flow rate=0.8 ml min⁻¹; injection volumes 20 μl). 0.5 % phosphoric acid was used as solvent A and 100 % HPLC grade methanol as solvent B for separation of anthocyanins (elution conditions: 0-38 min from 3 % B to 65 % B; from 38-45 min, 65 % B; flow rate=1 ml min⁻¹, injection volumes were 20 μl) (Jakobek et al., 2007a, Jakobek et al., 2007b). UV-Vis spectra were recorded in a wavelength range from 190-600 nm (the detection wavelength was; 320 nm for chlorogenic, neochlorogenic acid; 360 nm for quercetin-3-rutinoside; 520 nm for anthocyanins). The total peak area at 320 nm was used for the quantification of total phenolic compounds in fraction 1 by using the chlorogenic acid calibration curve. The total peak area at 520 nm was used for the quantification of total phenolic compounds in fraction 2 and 3 by using the cyanidin-3-glucoside calibration curve.

Antiradical activity

The antiradical activity was measured spectrophotometrically with a UV-Vis spectrophotometer (UV 2005, Barcelona, Spain) by using the DPPH test (Brand-Williams et al., 1995). DPPH solution was prepared by diluting 10 to 400 μl DPPH (1mmol dm⁻³) in methanol to final volume of 3 ml and absorbance was measured at 517 nm. The DPPH calibration curve was constructed by plotting the DPPH[•] radical amount (μmol) vs absorbance (Eq. 1):

$$y = 0.2594x + 0.0042 \quad (1)$$

where:

$$\begin{aligned} y &= \text{amount of DPPH}^{\bullet} \text{ radicals } (\mu\text{mol}) \\ x &= \text{absorbance} \end{aligned}$$

Three dilutions of each phenol fractions (1, 2 and 3) were prepared. Each dilution contained an aliquot of individual fraction, 200 μl of methanolic DPPH[•]

solution (1mmol dm^{-3}) and methanol to final volume of 3 ml. The absorbance was read against the blank solution (prepared using 200 μl of methanol instead of DPPH^{*} solution) in period of 300 minutes. The amount of DPPH^{*} radicals were calculated in each moment of reaction according to the DPPH calibration curve and % of remaining DPPH^{*} radicals according to Eq. 2:

$$\% \text{ of remaining DPPH} = \frac{n(\text{DPPH})_t}{n(\text{DPPH})_0 / 100} \quad (2)$$

where:

$n(\text{DPPH})_t$ = amount of DPPH^{*} radicals (μmol) in time t

$n(\text{DPPH})_0$ = amount of DPPH^{*} radicals (μmol) in $t=0$

% inhibition of DPPH^{*} radicals were calculated according to Eq. 3:

$$\% \text{ inhibition} = 100 - \% \text{ of remaining DPPH} \quad (3)$$

Afterwards, the same volumes of phenolic fractions were mixed at various combinations. The antiradical activity of mixtures was determined by the same procedure as in individual phenol fractions. The antiradical activity of individual fractions was summed up and compared to the antiradical activity of mixtures.

Results and discussion

Phenolic fractions were extracted from chokeberries by procedure already described in the literature (Määttä-Riihinen et al., 2004a; Määttä-Riihinen et al., 2004b). The major phenolic compounds were identified by HPLC. Fig. 1, 2 and 3 show HPLC chromatograms of phenolic fractions with identified phenolic compounds.

In the first fraction, the major phenolic compounds extracted with ethyl acetate (Fig. 1) were neochlorogenic acid, chlorogenic acid and quercetin-3-rutinoside (rutin), in the total amount of 1472 mg/kg of fresh weight (F.W.). This agrees with literature data (Määttä-Riihinen et al., 2004a, Bermúdez-Soto and Tomás-Barberán, 2004; Slimestad et al., 2005).

The second fraction contained four major anthocyanins (Fig. 2), in the total amount of 8503 mg kg^{-1} of FW. All of them were cyanidin derivatives. This agrees with our previous investigations and with literature data (Määttä-Riihinen et al., 2004a; Jakobek et al., 2007a; Bermúdez-Soto and Tomás-Barberán, 2004; Slimestad et al., 2005).

After the extraction of major parts of free and conjugated forms of hydroxycinnamic acids, flavonols (Fraction 1) and anthocyanins (Fraction 2), the extraction residue was acid hydrolyzed to liberate insoluble high molecular weight (HMW) proanthocyanidins as anthocyanidins. Fig. 3 shows the chromatogram of the third fraction with the total amount of phenols 235 mg kg^{-1} F.W.

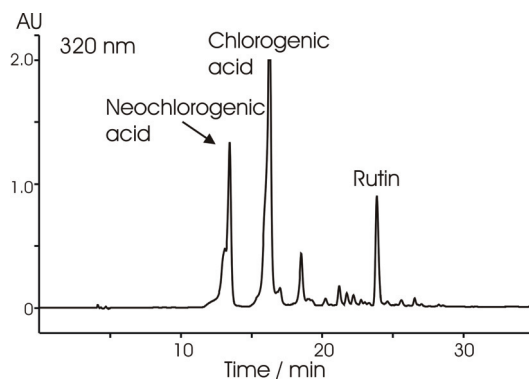

Fig. 1. The HPLC chromatogram of the first fraction extracted with ethyl acetate, recorded at 320 nm, with identified major phenolic acids and flavonols

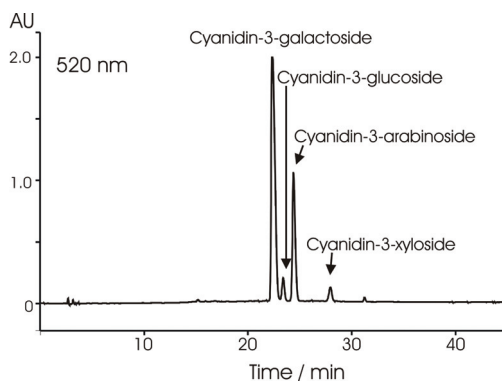

Fig. 2. The HPLC chromatogram of the second fraction extracted with acidified methanol, recorded at 520 nm, with identified major anthocyanins

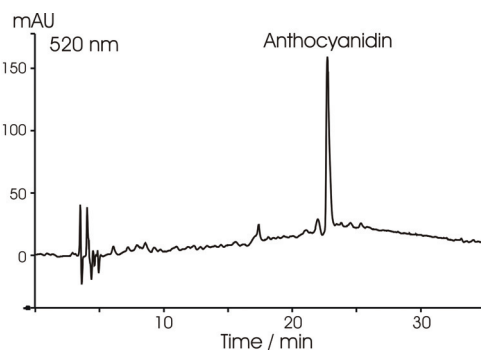

Fig. 3. The HPLC chromatogram of the third fraction extracted with acidified methanol and reflux, recorded at 520 nm

The ability of chokeberry phenols to scavenge free DPPH[•] radicals was studied by using the DPPH method. The reaction was monitored over a period of 300 minutes. The antiradical activity was monitored in individual phenolic fractions and expressed as % inhibition of DPPH[•] radicals. After that, the same concentrations of phenolic fractions were mixed and their antiradical activity was determined and expressed as % inhibition of DPPH[•] radicals. The measured antiradical activity caused by phenolic mixtures was compared to the summated values which were obtained by summing up the antiradical activity of individual phenolic fractions. In that way it could be seen if the antiradical activity of phenolic mixtures was lower or higher than predicted antiradical activity (summated values).

Fig. 4, 5, and 6 show the antiradical activity of individual phenol fractions (summated values) and phenolic mixtures (measured values). The results show that all phenols needed 4 or 5 hours to reach the steady state. Similar type of behavior was reported earlier in the study of Brand-Williams et al. (1995). They reported three types of kinetic behavior in the reaction between antioxidant compounds and DPPH[•] radicals, rapid, intermediate and very slow kinetic behavior (Brand-Williams et al., 1995). In this study, in the reaction between chokeberry phenols and free radicals, slow kinetic behavior was observed. Furthermore, all chokeberry phenols showed a biphasic reaction with fast and slow scavenging rates. Mixtures followed the reaction kinetic similar to that of individual fractions. Kinetic behavior was slow and mixed phenols needed 4 to 5 hour to reach the steady state. Moreover, the reaction between mixtures and DPPH[•] radicals was biphasic with fast and slow scavenging rates.

Furthermore, the results show that all phenolic mixtures (measured values) had lower antiradical activity than it was predicted by summing up antiradical activities of individual fractions (Fig. 4, 5 and 6). The mixing of various phenolic fractions caused the decrease of the antiradical activity. This indicated that phenolic combinations showed a tendency toward decreased antiradical activity. In other words, mixtures of various chokeberry phenols showed negative synergism. Negative synergism was observed earlier as well (Pinelo et al., 2004). In the study of Pinelo et al., (2004), the antiradical activity was determined by using the DPPH test, and the mixture of catechin, resveratrol and quercetin showed lower antioxidant activity in comparison to the trend followed by each single phenol. Negative synergism can be the result of various interactions between phenolic compounds. Phenolic compounds can be involved in various polymerization reactions which can increase their molecular complexity and affect their ability to react with free radicals. This leads to the decrease of the antiradical activity. Interactions between phenolic compounds from chokeberries could affect the total antiradical activity of chokeberries. The results also suggest that more complex systems could have lower antiradical activity in comparison to the simple ones.

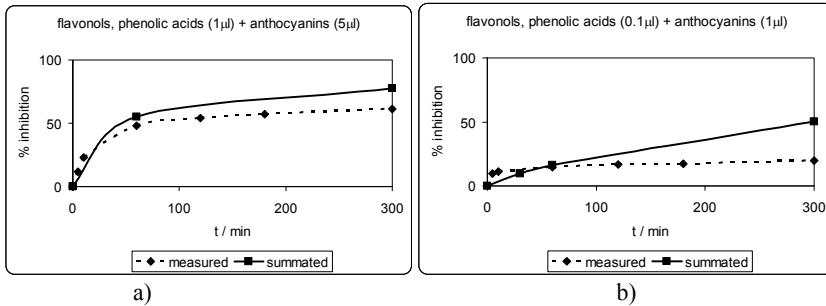

Fig. 4. The antiradical activity of mixtures of fraction 1 (flavonols, phenolic acids) and fraction 2 (anthocyanins) and comparison with the trend followed by individual fractions. The antiradical activity was expressed as % inhibition of DPPH[•] radicals, and figures a) and b) represent different concentrations of mixtures. Summated antiradical activity denotes the sum of antiradical activities of individual phenol fractions. Measured antiradical activity represents total antiradical activity of the phenol mixture.

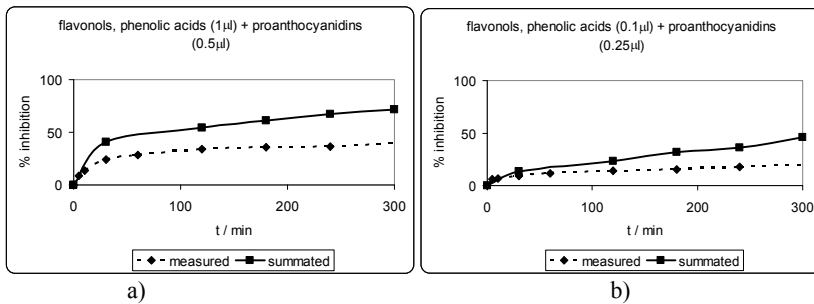

Fig. 5. The antiradical activity of mixtures of fraction 1 (flavonols, phenolic acids) and fraction 3 (proanthocyanidins as anthocyanidins) and comparison with trend followed by individual fractions. The antiradical activity was expressed as % inhibition of DPPH[•] radicals, and figures a) and b) represent different concentrations of mixtures. Summated antiradical activity denotes the sum of antiradical activities of individual phenol fractions. Measured antiradical activity represents total antiradical activity of the phenol mixture.

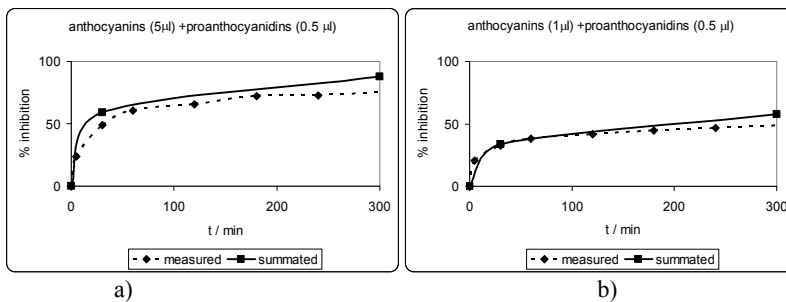

Fig. 6. The antiradical activity of mixtures of fraction 2 (anthocyanins) and fraction 3 (proanthocyanidins as anthocyanidins) and comparison with trend followed by individual fractions. The antiradical activity was expressed as % inhibition of DPPH[•] radicals, and figures a) and b) represent different concentrations of mixtures. Summated antiradical activity denotes the sum of antiradical activities of individual phenol fractions. Measured antiradical activity represents total antiradical activity of the phenol mixture.

Conclusions

Results obtained in this study showed that the mixing of phenolic compounds from chokeberries created more complex phenolic system, and promoted changes in the antiradical activity of chokeberries. Phenolic mixtures showed the tendency toward the decrease of the antiradical activity of chokeberries. Lower antiradical activity of phenolic mixtures can be the result of various interactions occurring between phenolic compounds in more complex systems. When producing food enriched with phenolic compounds, all of these effects should be considered.

References

- Bermúdez-Soto, M.J., Tomás-Barberán, F.A. (2004): Evaluation of commercial red fruit juice concentrates as ingredients for antioxidant functional juices, *Eur. Food Res. Technol.* 219 (2), 133-141.
- Bermúdez-Soto, M.J., Larrosa, M., García-Cantalejo, J., Espín, J.C., Tomás-Barberán, F.A., García-Conesa, M.T. (2007a): Transcriptional changes in human caco-2 colon cancer cells following exposure to a recurrent non-toxic dose of polyphenol-rich chokeberry juice, *Genes Nutr.* 2, 111-113.
- Bermúdez-Soto, M.J., Larrosa, M., García-Cantalejo, J.M., Espin, J.C., Tomás-Barberán, F.A., García-Conesa, M.T. (2007b): Up-regulation of tumor suppressors carcinoembryonic antigen-related cell adhesion molecule 1 in human colon cancer Caco-2 cells following repetitive exposure to dietary levels of a polyphenol-rich chokeberry juice, *J. Nutr. Biochem.* 18, 259-271.
- Brand Williams, W., Cuvelier, M.E., Berset, C. (1995): Use of a free radical method to evaluate antioxidant activity, *Lebensm.-Wiss. U. Technol.* 28, 25-30.
- Jakobek, L., Šeruga, M., Medvidović-Kosanović, M., Novak, I. (2007a): Anthocyanin content and antioxidant activity of various red fruit juices, *Dtsch. Lebensm.-Rundsch.* 103 (2), 58-64.
- Jakobek, L., Šeruga, M., Novak, I., Medvidović-Kosanović, M. (2007b): Flavonols, phenolic acids and antioxidant activity of some red fruits, *Dtsch. Lebensm.-Rundsch.* 103 (8), 369-378.
- Jurgoński, A., Juśkiewicz, J., Zduńczyk, Z. (2008): Ingestion of black chokeberry fruit extract leads to intestinal and systemic changes in a rat model of prediabetes and hyperlipidemia, *Plant Foods Hum. Nutr.* 63, 176-182.
- Kulling, S.E., Rawel, H.M. (2008): Chokeberry (*Aronia melanocarpa*)-A review on the characteristic components and potential health effects, *Planta. Med.* 74, 1625-1634.
- Määttä-Riihinen, K.R., Kamal-Eldin, A., Mattila, P.H., González-Paramás, A.M., Törrönen, A.R. (2004a): Distribution and content of phenolic compounds in eighteen scandinavian berry species, *J. Agric. Food Chem.* 52 (14), 4477-4486.
- Määttä-Riihinen, K.R., Kamal-Eldin, A., Törrönen, A.R. (2004b): Identification and quantification of phenolic compounds in berries of *Fragaria* and *Rubus* species (Family Rosaceae), *J. Agric. Food Chem.* 52 (20), 6178-6187.

Topic: Food technology and biotechnology

- Määttä-Riihinen, K.R.; Kähkönen, M.P., Törrönen, A.R., Heinonen, M.I. (2005): Catechins and proanthocyanidins in berries of *Vaccinium* species and their antioxidant activity, *J. Agric. Food Chem.* 53, 8485-8491.
- Pinelo, M., Manzocco, L., Nunez, M.J., Nicoli, M.C. (2004): Interaction among phenols in food fortification: negative synergism on antioxidant capacity, *J. Agric. Food Chem.* (52), 1177-1180.
- Slimestad, R., Torskangerpoll, K., Nateland, H.S., Johannessen, T., Giske, N.H. (2005): Flavonoids from black chokeberries, *Aronia melanocarpa*, *J. Food Compos. Anal.* 18, 61-68.
- Wu, X., Gu, L., Prior, R.L., McKay, S. (2004): Characterization of anthocyanins and proanthocyanidins in some cultivars of *Ribes*, *Aronia*, and *Sambucus* and their antioxidant capacity, *J. Agric. Food Chem.* 52 (26), 7846-7856.
- Zheng, W.; Wang, S.Y. (2003). Oxygen radical absorbing capacity of phenolics in blueberries, cranberries, chokeberries, and lingonberries, *J. Agric. Food Chem.* 51 (2), 502-509.

Technical criteria for the development of calibrations for moisture meters

UDC: 551.508.7 : 531.72

V. Jocić^{1*}, A. Škalić², K. Buntak¹

¹*State Office for Metrology, Ulica grada Vukovara 284, 10000 Zagreb, Croatia*

²*Inspecto d.o.o. for the control of the quality of goods, Električne Centrale 1, 31400 Đakovo, Croatia*

Summary

Dielectric (capacitive) technology used by the moisture meters for grains and oilseeds is based on the principle of the relation between the moisture content and the dielectric constant. The dielectric constant increases with the increase in moisture (water) content. Since the rate of increase is not the same for all types of grain, the unique calibration constants have to be developed for each type of grain whose moisture is measured using the moisture meter. Water content in grain is important for the storage of grain, and the accuracy of the results affects forming of the price on the market. Due to different measurement results, which are within the bounds of the maximum permissible error and occur in cases of the same model of moisture meters, there may be a lack of trust between the producers and the buyers of grain. Since it is a quick method and the instrument has a clearly defined permissible error at verification, the only solution to this problem is standardisation of calibration constants. The testing laboratory of the State Office for Metrology, which prepares samples for verification of moisture meters, has initiated the development of calibration constants for barley and wheat that render possible maximum level of homogeneity of measurement results. The laboratory has also set the technical criteria for making and testing in the first phase, followed by the implementation and the development of the constants for other agricultural cultures. For the purposes of development of calibration in this paper used the minimum number of prepared samples of barley (11) which is determined by the standard method of moisture, and has made corrections to the calibration of the existing commercial moisture meter. Measurement of the moisture meter was made before the correction, and show an error which is expressed as the mean absolute amount of the moisture meter measurements in relation to the reference method of 0.190, after correcting the calibration error is reduced to 0.038. This paper describes the process of developing calibration. The technical criteria for the development of calibrations are a group of methods consisting of sample collecting, determination of the moisture content for the grain using the standard ISO 712:2009 method, measuring with the moisture meter, computer processing of the results using the programme for calibrations and our own method of monitoring the conditions of handling the samples used for verification of moisture meters.

Keywords: moisture meters, moisture content, calibration, standardisation

* vlatka.jocic@dzm.hr

Introduction

One of the primary activities of the State Office for Metrology is verification of legal measuring instruments and ensuring the public guarantee concerning the safety and adequate accuracy of measurements for the purpose of free trade and consumer protection. The work of the State Office laboratory which prepares samples for verification of moisture meters is primarily dedicated to the development, monitoring and improvement of the methods of sample making as the basic tool for the verification. However, the measurements on site show that there is a difference in the results between the individual moisture meters. The reason for this lays in the non-unified calibration constants of different origins and obsolete technical requirements (OG 44/94) which do not include the software into the examination of the measuring instruments in such a way as to carry out the standardisation of the calibration constants, which are then necessary to be implemented into the legislation as part of the technical requirements.

The analysis of the measuring instruments in the Republic of Croatia which are used in the commercial transactions of agricultural cultures has shown that the model of technical criteria for the development of calibrations must be adapted to the existing situation in such a way as to be easily applicable, sustainable, understandable for all users and able to keep pace with the development of new technologies.

Taking into consideration the diversity of agroclimatic conditions of the grain-producing countries, the models corresponding to the individual geographic areas are applied (GIPSA, 1999), which follow the general instructions of the umbrella metrological organisation. A few years of analysis of grain with different moisture content from the same geographical area are needed for the development of calibration constants for moisture meters (three or more, depending on the type of the agricultural culture). The data are evaluated and rough errors eliminated, after which follow testing and implementation of the approved calibrations (OIML R 59, 2009). The US Federal Grain Inspection Service approves the official calibrations for the measuring instrument GAC 2100 manufactured by Dickey-John with nine years of validity for certain cultures. In this way the occurrence of deviation of the result is reduced to the minimum, and the calibration procedure refers to the official measuring instrument (GIPSA, 1999). The advantages of this model are a large database for the measurement data and the simplicity of the procedure (everyone uses the same model of instrument). In spite of the uniformity of results, this model shows some defects in terms of the lack of flexibility towards the other measuring instruments manufacturers and some changes are therefore being prepared (Pierce, 2009). The verification model applicable for the use of moisture meters produced by various manufacturers is used in France where it is possible for the manufacturer of the measuring instrument to develop the calibration constants if it is verified by the competent institution (NLE, France), which is periodically controlled by the relevant regional office (DRIRE, France).

Since there are no manufacturers of moisture meters in Croatia and there are few models of measuring instruments with type approval in use, the calibration constants on the instruments are mostly factory settings or their modifications. At the occasion of measuring instrument verification, Agrionica d.o.o., company for moisture meter servicing has been using the unified calibration constants over the last three years (applied to 90 moisture meters manufactured by Dickey-John). The constants have been approved by the State Office and the analysis has shown that the repeatability of measuring is satisfactory, which has rendered possible the writing of guidelines referring to the technical criteria for the development of calibrations. Besides, a correction of calibration constants has been carried out in cooperation with Chopin Technologies, the moisture meter manufacturer from France, and Agrionica d.o.o. service, with the samples in the laboratory of the State Office on the Aqua TR meter, which is new on the Croatian market and technologically very advanced. The results obtained have confirmed the procedure and unified it within the technical criteria for the development of the calibration for moisture meters, which is shown in this work.

Materials and methods

Material

The used samples of barley have been gathered by the Inspecto d.o.o. inspection company at the time of harvest (2010) in the silos in Đakovo and Osijek, in accordance with the HRN ISO 950:1999 method.

No more than 24 hours should pass from the time of sample gathering to the time of processing and storing in the controlled conditions. During the transportation the samples must be kept from major temperature changes which would lead to the loss of moisture.

Working conditions in the laboratory

The manipulation of samples and the measurements are carried out in controlled laboratory conditions. The laboratory temperature: from 20 to 23 °C, maximum change of 1 °C/h, air humidity from 30 to 55 %. The measuring instruments for monitoring of the conditions (thermometer, hygrometer) are calibrated periodically (once a year).

Preparation of samples and storage

Admixtures and damaged grains are removed from the samples by means of mechanical sifting through adequate sieves. The sample is accepted if it is completely purified from admixtures and without dust, and if the grain is healthy, without odour and of a colour characteristic for its type. The mass of the sample is from 1000 to 1500 g. Purified and marked sample (year of harvest, origin, number of

samples) is vacuum-packed in plastic foil and stored in a refrigerator (storage temperature is from 5 to 8 °C) or set to laboratory conditions for 12 hours and then used. Vacuum-packing of the sample has proven to be the best way of keeping, compared with the storage in a plastic container with a lid or a jar with a ground stopper, because it reduces the contact of the sample with the air and prevents the development of microorganisms. In case of samples with low content of moisture, this manner of storage delays the date of expiry up to one year.

Humidity determination using the curing shed method

The moisture of the sample is determined by means of the ISO 712:2009 method for grain in accordance with all the requirements of the method. The analysis is carried out in controlled laboratory conditions (*Storage conditions and environment*). The analysed sample is taken from the vacuum bag, so that its part needed for moisture determination can be taken out (c. 30 g) and vacuum-packed again. The sample exposure to the air and to the temperature changes has to be reduced to the minimum. The samples are hermetically sealed all through the grinding procedure, until their weighing.

Measuring of moisture using moisture meters

The moisture meter used in this case was Aqua TR with the factory calibration constant for barley, manufactured by Chopin technologies from France. The moisture meter was turned on and acclimatized under the laboratory conditions (for 12 hours, in accordance with manufacturer's instructions), and the measuring of barley was carried out (Table 1). The results achieved are within the limits of the permissible error for the initial verification of the measuring instrument (OG 44/1996).

Table 1. Measuring moisture of barley using a moisture meter

Rec.	Date / Time	Num.	Calibrations	H%	HLW(kg/ha)
0001	2010/08/25 08:4...	007	JECAM	11.50	68.00
0002	2010/08/25 08:5...	007	JECAM	15.38	66.97
0003	2010/08/25 08:5...	007	JECAM	13.60	57.03
0004	2010/08/25 08:5...	007	JECAM	11.75	68.34
0005	2010/08/25 08:5...	007	JECAM	15.19	62.02
0006	2010/08/25 08:5...	007	JECAM	10.23	66.11
0007	2010/08/25 09:0...	007	JECAM	14.40	68.69
0008	2010/08/25 09:0...	007	JECAM	9.58	63.63
0009	2010/08/25 09:0...	007	JECAM	12.70	67.21
0010	2010/08/25 09:0...	007	JECAM	16.27	67.57

Results and discussion

After the measuring with the moisture meter using the existing calibrations (linear), the value measured using the curing shed method is added to the results in the table of the program for the calculation of calibration delivered by the manufacturer of the measuring instrument (Table 2). The correction of the calibration coefficient is carried out based on the calculation from the resulting parameters and the calibration curve (Fig. 1).

Table 2. Calculation (Cal) of coefficients for calibration constant

Cal			
H% Linear	H% Reference	H% Calculated	Difference
11.5	11.99	-1.7	13.7
15.38	14.93	2.8	12.1
13.6	13.6	0.8	12.8
11.75	12.16	-1.4	13.6
15.19	14.72	2.6	12.1
10.23	10.86	-3.4	14.3
14.4	14.06	1.7	12.3
9.58	10.41	-4.3	14.7
12.7	12.93	-0.2	13.2
16.27	15.87	3.7	12.2
10.17	11.34	-3.5	14.8
Average	12.99	-0.27	13.26
Minimum	10.41	-4.29	12.14
Maximum	15.87	3.71	14.82
Nb value	11		

Calibration AQUA-TR / AGRI-TR

Product :	a0	a1	a2	a3
	-21	2	-4	3

$$H = a_0 + a_1 * \text{lin} + a_2 / 100 * (\text{lin})^2 + a_3 / 10000 * (\text{lin})^3$$

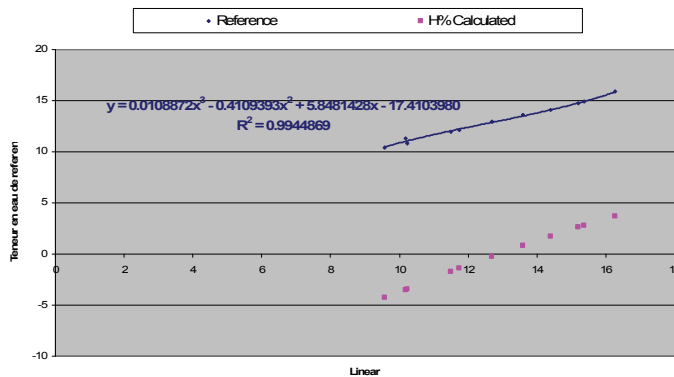

Fig. 1. Calibration curve

The average difference of the deviation value for barley between the moisture measured by means of a curing shed and measured using the moisture meter is 0,19 (Table 3). The value for correction is entered into the settings of the moisture meter, after which it is sent to the manufacturer of the measuring instrument who includes the new value of the calibration constant into the calibration base. The measuring shows the reduced result error.

Table 3. Moisture (H%) measured by use of moisture meter and reference value before and after the correction

1 ST MEASUREMENT			2 ND MEASUREMENT		
H% Linear 1	H% Reference	Difference1	H% Linear2	H% Reference	Difference2
11.5	11.99	-0.45	11.83	11.99	0,16
15.38	14.93	0	15,44	14.93	-0,51
13.6	13.6	0.41	13,83	13.6	-0,23
11.75	12.16	-0.47	12,24	12.16	-0,08
15.19	14.72	0.63	15,19	14.72	-0,47
10.23	10.86	-0.34	10,59	10.86	-0,57
14.4	14.06	0.83	14,63	14.06	0,47
9.58	10.41	0.23	9,94	10.41	-0,02
12.7	12.93	-0.4	12,95	12.93	-0,44
16.27	15.87	1.17	16,31	15.87	1
		0.1909090			-0,0381818

After the correction, the calibration constant is entered into the measuring instrument (Fig. 2) and the measuring is repeated with the same samples. The calibration constant is marked by its name and number, and stored in the memory of the measuring instrument.

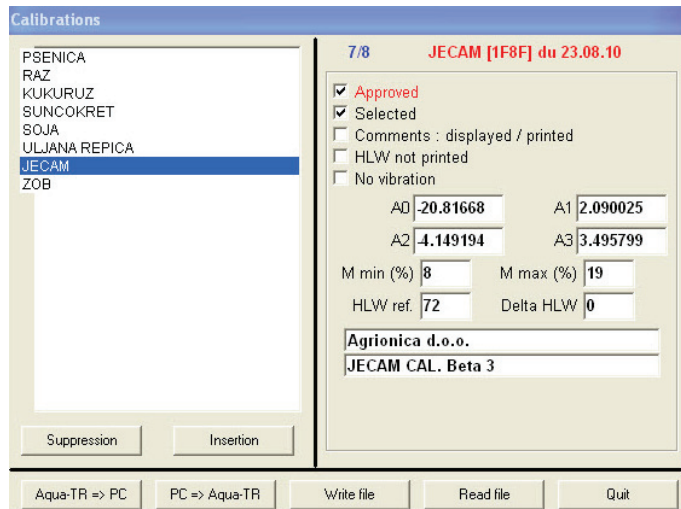

Fig. 2. Calibration constant on the moisture meter

Conclusions

The measuring has been carried out on eleven samples of barley with the moisture range from 10.41 % to 15.87 %, which represents the minimum necessary for the correction of the calibration constant, despite the fact that there is an obvious reduction of the error, which is the objective of this work. The procedure is also completely applicable in case of the measuring instruments by other manufacturers of moisture meters used for measuring moisture in grains and oilseeds in Croatia. The experience has shown that the manufacturers cooperate on the development of the calibration constants because the reliability of their measuring instruments is in their best interest, and the reduction of the error means the most to the users of the measuring instruments because it guarantees fair trade. Furthermore, it is obvious from this example that the possible correction of the existing calibration is successful. The described procedure of sample preparation and measurement for the complete development of the new constant, when necessary, is the same with the greater number of samples (it is defined for each agricultural culture separately) taken from at least three harvests for the same culture (USDA, 1999). According to the information by the State Office, the standardisation of the existing calibrations in the Republic of Croatia is implementable to the majority of meters in use in the period of two years, in the sequence determined by the criteria of representation in the agricultural production. The technical criteria for the development of calibration constants and their implementation should be included into the Ordinance on metrological requirements for moisture meters, as well as the definition of the correct calibration and the conditions under which it is corrected or completely replaced with a new one.

Acknowledgments

Measurements using the moisture meter of Aqua TR model manufactured by Chopin technologies and the program support have been enabled by the company Agrionica d.o.o. from Požega.

References

- Determination of moisture content – Reference method. ISO 712:2009.
International Organization of Legal Metrology, “Moisture Meters for Cereal Grain and Oilseeds”, Fifth Committee Draft Revision International Recommendation 59, OIML TC17/SC1: 5. Metrological requirements, 15; 6. Technical requirements, 20; 7. Practical Instructions, 27; 8. Metrological Controls, 27. (2009)
International Standards Organisation: Cereals and Cereal product

Topic: Food technology and biotechnology

Pierce, R.O., Brenner, C.A., Freese, L.A., Funk, D.B. (2009): Standardizing Grain Moisture Meter Performance an On-going Calibration Program, An ASABE Meeting, Presentation, Paper Number: 096619, 2-6.

State Office for Metrology: The Metrological Requirements for Moisture Meters for Cereal Grain and Oilseeds, OB 44/1996.

United States Department of Agriculture, Marketing and Regulatory Programs Grain Inspection, Packers and Stockyards Administration, Federal Grain Inspection Service, Grain Moisture Handbook, Washington DC, ,Chapter 2: 2.1 General Requirements, Moisture Meter Calibration, ,2.3 Equipment Requirements, 2-2; 2.4 Annual Calibrations Study, 2-2; 2.6 Criteria For Changes, 2-5., Chapter 3: 3.2 Operations, 3-4; Testing official moisture meters, 3-10, January 1999.

Flavonoids in Croatian Chestnut (*Castanea sativa*) honey

UDC: 638.162 (497.5)

D. Kenjeric*, M. L. Mandić, Lj. Primorac, F. Čačić

*University of Josip Juraj Strossmayer in Osijek, Faculty of Food Technology Osijek,
Franje Kuhača 20, HR-31000 Osijek, Croatia*

Summary

All honey types can be generally described as supersaturated sugar solutions, but at the same time they differ in components, such as flavonoids, which are present in small amounts but are responsible for many of their specific properties. The aim of this study was to determine the content of flavonoids in Croatian unifloral chestnut (*Castanea sativa*) honey. For that purpose 9 chestnut honey samples, for which characterisation was achieved by the combination of physicochemical properties and pollen analysis, have been analysed. Flavonoid fraction was extracted from honey and then analysed using reversed-phase high performance liquid chromatography (RP-HPLC) method. Flavonoids myricetin, quercetin, luteolin, kaempferol, apigenin, isorhamnetin, chrysin and galangin were identified and quantified in each sample. Total amount of identified flavonoids varied from 149 µg/100 g of honey to 313 µg/100 g of honey, with the average of 231 µg/100 g of honey. All analysed samples showed common flavonoid profile.

Keywords: Croatian unifloral chestnut honey, flavonoids, RP-HPLC analysis

Introduction

Honey is supersaturated sugar solution which, besides the sugars, contains many other compounds e.g. organic acids, proteins, amino acids, minerals, vitamins and phytochemicals.

While the gross composition of honey is of concern to the regulatory authorities who are attempting to ensure that the public does not purchase adulterated products, it is important to remember that honey also contains a wide range of trace substances which may well endow the product with special therapeutic properties. The identification of minor compounds from honey is in the most cases a demanding but worthwhile task, because many of those compounds may well contribute to its reputation as a “health food” (Al-Qassem and Robinson, 2003).

At the top of the list of the biologically active components present in honey are flavonoids, class of natural compounds that recently has been the subject of considerable scientific and therapeutic interest.

Flavonoids are major functional compounds which are proven to have antioxidative (Alan and Miller, 1996), antibacterial (Weston, 2000), antitumor

* daniela.kenjeric@ptfos.hr

and anti-HIV (Wang et al., 1998; Ren et al., 2003) properties, but their usage for medicinal purposes is still in many developed countries allowed only in the form of natural flavonoid mixtures (herbal and insect preparations, e.g., propolis or honey) which are considered as supplements, while their marketing as drugs is very limited (Havsteen, 2002).

Amounts of the total flavonoids found in honey are about 6000 µg/kg (Anklam, 1998), and the presence of particular flavonoids depends on the botanical origin of honey.

The aim of this work was to determine the flavonoids present in the Croatian unifloral *Castanea* honey.

Materials and Methods

Honey samples

9 samples of *Castanea* honey were provided by the beekeepers from different parts of the Republic Croatia.

Though beekeepers, based on the position of the hives and flowering season, declared samples as unifloral *Castanea* honey, all the samples were subjected to pollen analysis with the aim of confirming honey type. Additional characterisation of the samples was achieved by the physicochemical attributes analysis in compliance with Croatian Regulation (Ministry of Agriculture and Forestry, 2000) and Harmonised methods of the European Commission (Bogdanov et al., 1997). Afterwards, samples were stored till the flavonoids analysis. Since flavonoids are relatively stable compounds, resistant to heat, oxygen and moderate degrees of acidity honey samples were prior to analysis stored in dark place but at room temperature (Peterson and Dwyer, 1998).

Pollen analysis

Analysis was conducted according to the method of Croatian Regulation (Ministry of Agriculture and Forestry, 2000), and identification of pollen grains was made by reference to the literature data (Von der Ohe and Von der Ohe, 2003) and personal comparative preparations.

Physicochemical analysis

Physicochemical parameters were determined according the methods prescribed by the Croatian Regulation (Ministry of Agriculture and Forestry, 2000) and Harmonised methods of the European Honey Commission (Bogdanov et al., 1997). Moisture content was determined using refractometric method, free acidity by titration of honey sample solution with 0.1M sodium hydroxide to pH

8.30, and electrical conductivity of the 20 % (w/v) water solution of honey (dry matter basis) was measured at 20.0 °C.

Flavonoids isolation

Flavonoids were isolated according to the method previously developed by Ferreres et al. (1994). Honey sample (*ca.* 50 g) was diluted with five parts of acidified water (pH adjusted on 2-3 with HCl). Solution was then passed through a glass column (25×2 cm) filled with Amberlite XAD-2 resins (pore size 9 nm, particle size 0.3-1.2 mm, Supelco, Bellefonte). During this passing the various phenolic compounds remained in the column, while sugars as well as other polar compounds were eluted with the aqueous solvent. Further, the column was washed with 100 mL of acidified water, and 300 ml of distilled water. The whole phenolic fraction was eluted with *ca.* 300 ml of methanol and taken to dryness under the reduced pressure. The dry residue was redissolved in 5 mL of distilled water and partitioned with ethyl ether (3×5 mL). The ether extracts were combined and ether removed under the reduced pressure. At the end of the extraction procedure, dry residue containing flavonoid fraction was redissolved in 0.5 mL of methanol and analysed by HPLC.

RP-HPLC analysis of honey flavonoids

For this purpose Varian ProStar liquid chromatographic system consisting of Solvent Delivery Module, Column Valve Module, UV/Vis Detector was used. Data were collected and analysed by ProStar 5.5 Star Chromatography Workstation and PolyView 2000 Ver. 6.0 Software. LiChrospher 100 RP-18 column (Merck, Darmstadt, Germany, 12.5×0.4 cm I.D., 5µm particle size) was used for separation of flavonoids. The mobile phase consisted of a mixture of water and formic acid (95:5) (solvent A) and methanol (solvent B) at a flow rate of 1 mL/min. To achieve better separation gradient elution was used starting with 30 % of methanol which remained isocratic for the first 15 minutes, and then followed by gradient to obtain 40 % of methanol at 20 min, 45 % of methanol at 30 min, 60 % of methanol at 50 min, 80 % of methanol at 52 min, and which then again become isocratic until the end of analysis in the 60 minutes. Chromatograms were recorded at 340 nm. The injection volume was 10 µL. The flavonoids identification was achieved through comparison of chromatographic data with authentic markers, while quantification was performed through external calibration data with the same compounds. Authentic markers were used for chromatographic comparison of data. Quercetin (3,3',4',5,7-Pentahydroxyflavone), luteolin (3',4',5,7-Tetrahydroxyflavone) and myricetin (3,3',4',5,5',7-Hexahydroxyflavone) were supplied by Sigma, while chrysin (5,7-Dihydroxyflavone), apigenin (4',5,7-Trihydroxyflavone), kaempferol (3,4',5,7-Tetrahydroxyflavone) galangin (3,5,7-Trihydroxyflavone) and isorhamnetin (3'-

Methoxy-3,4',5,7-tetrahydroxyflavone) were by Fluka (Buchs/Schweiz, Switzerland). Formic acid (Fluka) and methanol (Merck) were HPLC grade.

Data analysis

Mean values and standard deviations (SD) were calculated using computer programme Microsoft Excel 2000 (Microsoft Corp.).

Results and Discussion

Results of pollen analysis (Table 1) conducted with the aim of confirming the botanical origin showed that all samples, besides the sample M-72 which contains 84 % of *Castanea sativa* pollen grains, are in agreement with Croatian Regulation (Ministry of Agriculture and Forestry, 2000) which, due to strong over-representation of *Castanea sativa* pollen, prescribes minimum of 85 % for the declaration of honey as unifloral *Castanea* honey. Still, sample M-72 was included in further analyses due to the fact that it complied with prescribed values in all other parameters, and pollen analysis is known to have some problems (Anklam, 1998).

Table 1. Specific pollen content (%) and flavonoid content ($\mu\text{g}/100\text{ g}$ of honey) of Croatian unifloral *Castanea* honey samples

Sample code	% of <i>Castanea sativa</i> pollen grains	Flavonoids ($\mu\text{g}/100\text{ g}$ of honey)								
		MYR	QUE	LUT	KAE	API	ISH	CHR	GAL	Total
M-09	94	43.6	39.4	12.1	31.3	12.1	-	72.4	76.9	287.9
M-14	90	44.3	36.5	0.0	13.8	28.4	-	35.6	59.9	218.5
M-27	95	52.8	17.6	4.9	8.6	24.7	-	20.9	19.1	148.5
M-43	90	113.3	25.8	5.2	20.3	6.7	-	24.3	27.9	223.5
M-45	96	72.9	32.8	7.7	33.9	10.6	-	72.3	82.8	313.0
M-49	94	27.2	27.7	6.6	48.1	58.1	-	53.0	51.9	272.5
M-72	84	23.7	22.0	6.5	52.5	13.6	-	35.8	45.0	199.1
M-88	87	32.9	31.6	5.9	37.0	12.5	-	34.5	45.4	199.8
M-94	94	43.5	42.7	4.9	20.2	10.5	-	52.8	43.9	218.3
							-			
Mean	92	50.4	30.7	6.0	29.5	19.7	-	44.6	50.3	231.2
SD	4	27.7	8.2	3.2	15.0	16.0		19.1	20.7	51.1
MYR - myricetin, QUE - quercetin, LUT - luteolin, KAE - kaempferol, API - apigenin, ISH - isorhamnetin, CHR - chrysin, GAL - galangin; - flavonoid not detected										

Analysis of selected physicochemical parameters showed that all samples comply with the Croatian Regulation in the respect of water content and free acidity (Ministry of Agriculture and Forestry, 2000). Considering the electrical conductivity, two samples had lower values from the minimum (0.8 mS/cm) prescribed by the European Community Directive (The Council of the European Union, 2002), but since this parameter was not obligatory by the national Regulation, and they complied in other prescribed parameters, they were also included in further analysis.

The RP-HPLC analysis of isolated *Castanea* honey fraction revealed that all the samples have common flavonoid profile, which is shown on the Fig. 1. The largest chromatographic area, and therefore assumable the largest amounts of particular compounds, belong to the compounds that elute during the first ten minutes of the analysis. These are the unidentified phenolic acids. Identified flavonoids, which eluted during the next 50 minutes, were present in much smaller amounts than phenolic acids in all samples.

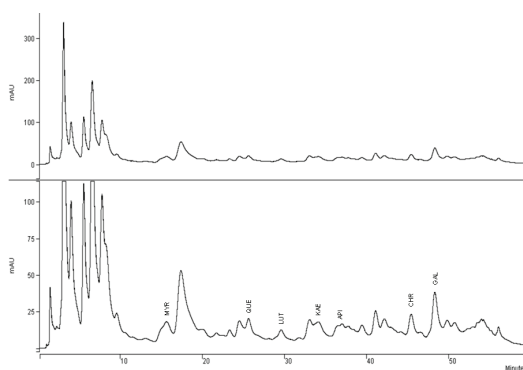

Fig. 1. Typical RP-HPLC chromatogram of flavonoids present in Croatian unifloral *Castanea* honey recorded at 340 nm. Up: whole area of absorbance. Down: Zoomed area of lower absorbances. Peaks: MYR- myricetin, QUE-quercetin, LUT-luteolin, KAE-kaempferol, API-apigenin, CHR-chrysin and GAL-galangin

Results of the flavonoid quantification conducted at 340 nm are shown in the Table 1. Average value of total identified flavonoids was $231.2 \pm 51.1 \mu\text{g}/100 \text{ g}$ of honey. Tomás-Barberán et al (2001) have reported 169-1300 μg of total flavonoids/100 g of honey for the Italian, Spanish, French and German *Castanea* honeys. In all analysed samples flavonols myricetin, quercetin and kaempferol, and flavones luteolin, apigenin, chrysin and galangin were found. Flavonol isorhamnetin, which was previously detected in rosemary (Gil et al., 1995),

heather (Ferrerres et al., 1994), and different types of French unifloral honeys (Soler et al., 1995), was not found in any of the samples.

Flavonoids originating from pollen-nectar contributed in average 58.9 % of total identified flavonoids, while propolis derived flavonoids chrysin and galangin contributed 41.1% of total flavonoid content (Fig 2.). Among pollen-nectar derived flavonoids, the most represented was myricetin (21.8 %, 50.4 µg/100 g of honey), followed by quercetin (13.3 %, 30.7 µg/100 g of honey), and kaempferol (12.8 %, 29.5 µg/100 g of honey). Flavone luteolin was present in the smallest amounts (2.6 %, 6.0 µg/100 g of honey) from all identified flavonoids.

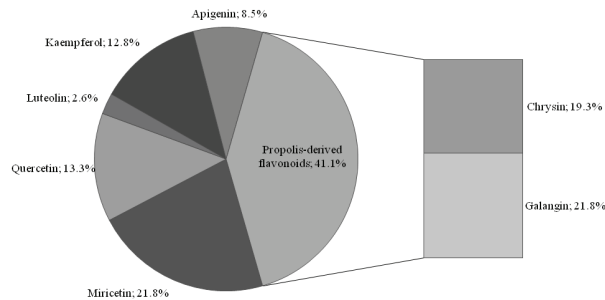

Fig. 2. Average share (%) of individual flavonoid compounds in total identified flavonoids

Castanea honey contained in average more total flavonoids than *Robinia* (208.4±111.8 µg/100 g of honey) (Kenjeric et al., 2007) and less than *Salvia* (288.5±114.3 µg/100 g of honey) (Kenjeric et al., 2008) honeys which were also produced in Croatia. Flavonol myricetin, which was the most represented from all identified pollen-nectar derived flavonoids in *Castanea* honey samples, was not present neither in *Robinia* (Kenjeric et al., 2007) nor in *Salvia* (Kenjeric et al., 2008) honey produced in Croatia. Additionally, it is noticeable that the share of pollen-nectar derived flavonoids in total identified flavonoids is higher in *Castanea* than in both previously reported honey types.

Conclusions

Content of total flavonoids in *Castanea* honeys varied from 148.5 µg/100 g of honey to 313.0 µg/100 g of honey. Pollen-nectar flavonoids dominated over propolis derived flavonoids.

Acknowledgement

This research was carried out as a part of the Technological project TP-02/0113-07 financed by the Ministry of the Science and Technology of the Republic of Croatia.

References

- Alan, L., Miller, N.D. (1996): Antioxidant flavonoids: structure, function and clinical usage, *Alt. Med. Rev.* 1, 103-111.
- Al-Qassem, R., Robinson R.K. (2003): Some special nutritional properties of honey – a brief review, *Nutr. Food Sci.* 33(6), 254-260.
- Anklam, E. (1998): A review of the analytical methods to determine the geographical and botanical origin of honey, *Food Chem.* 63, 549-562.
- Bogdanov S., Martin P., Lüllmann C. (1997): Harmonised methods of the European Commission. *Apidologie (extra issue)*
- Ferreres, F., Andrade, P., Tomás-Barberán, F.A. (1994): Flavonoids from Portuguese heather honey, *Z. Lebensm. Unters. Forsch.* 1991, 32-37.
- Ferreres, F., Tomás-Barberán, F. A., Soler, C., García-Viguera, C., Ortiz, A., Tomás-Lorente, F. (1994). A simple extractive technique for honey flavonoid HPLC analysis, *Apidologie.* 25, 21-30.
- Gil, M.I., Ferreres, F., Ortiz, A., Subra, E., Tomás-Barberán, F.A. (1995): Plant phenolic metabolites and floral origin of rosemary honey, *J.Agric. Food Chem.* 43, 2833-2838.
- Havsteen, B.T. (2002): The biochemistry and medical significance of the flavonoids, *Pharmacol. Therapeut.* 96(2-3), 67-202.
- Kenjeric, D., Mandić, M.L., Primorac, Lj., Bubalo, D., Perl, A. (2007): Flavonoid profile of *Robinia* honeys produced in Croatia, *Food Chem.* 102, 683-690.
- Kenjeric, D., Mandić, M.L., Primorac, Lj., Čačić, F. (2008): Flavonoid pattern of sage (*Salvia officinalis* L.) unifloral honey, *Food Chem.* 110, 187-192.
- Ministry of Agriculture and Forestry (2000): Regulation on the quality of honey and other bee products, *Official Gazette.* 20, 642-652.
- Peterson, J., Dwyer, J. (1998): Flavonoids: Dietary occurrence and biochemical activity, *Nutr. Res.* 18(12), 1995-2018.
- Ren, W., Qiao, Z., Wang, H., Zhu, L., Zhang, L. (2003): Flavonoids: Promising anticancer agents, *Med. Res. Rev.* 23, 519-534.
- Soler, C., Gil, M., García-Viguera, C., Tomás-Barberán, F.A. (1995): Flavonoid patterns of French honeys with different floral origin, *Apidologie.* 26(1), 53-60.
- The Council of the European Union (2002): Council Directive 2001/110/EC of 20 December 2001 relating to honey, *Off. J. Eur. Commun.* 10, 47-52.
- Tomás-Barberán, F.A., Martos, I., Ferreres, F., Radovic, B.S., Anklam, E. (2001): HPLC flavonoid profiles as markers for the botanical origin of European unifloral honeys, *J. Sci. Food Agric.* 81(5), 485-496.
- Von der Ohe K., Von der Ohe W. (2003): Celle's Mellisopalynological Collection, Celle, Germany: Niedersächsisches Landesinstitut für Bienenkunde.
- Wang, H.K., Xia, Y., Yang, Z.Y., Nataschke, S.L., Lee, K.H. (1998): Recent advances in the discovery and development of flavonoids and their analogues as antitumor and anti-HIV agents, *Adv. Exp. Med. Biol.* 439, 191-225.
- Weston, R.J. (2000): The contribution of catalase and other natural products to the antibacterial activity of honey, a review, *Food Chem.* 71, 235-239.

Influence of trehalose addition on selected aroma compounds in strawberry cream fillings

UDC: 641.451 : 66.022.3

M. Kopjar^{1*}, J. Hribar², M. Simčič², E. Zlatič², V. Piližota¹

¹*University of Josip Juraj Strossmayer in Osijek, Faculty of Food Technology Osijek, Franje Kuhača 20, 31000 Osijek, Croatia*

²*University of Ljubljana, Biotechnical Faculty, Jamnikarjeva 101, 1000 Ljubljana, Slovenia*

Summary

Aroma is one of the most important quality properties in food products and has great influence on acceptability of foods. Since it is very difficult to control it, in this study addition of different amounts of trehalose (3, 5 and 10 %) to strawberry cream fillings were used as possible tool for retention of selected aroma compounds which are the most responsible for strawberry aroma. Selected aroma compounds were fruity esters (ethyl acetate, ethyl butanoate, 2 methyl-ethyl butanoate, 3 methyl-ethyl butanoate, ethyl pentanoate, methyl-ethyl pentanoate, ethyl hexanoate, methyl hexanoate, methyl butanoate), γ -decalactone and furaneol. Samples were prepared without and with addition of strawberry aroma, thus influence of initial amount of aroma compounds was also observed. Overall looking, trehalose addition caused retention of fruity esters with exception of ethyl acetate. Increase of trehalose addition did not cause proportional increase in fruity esters amount. However, in the case of γ -decalactone and furaneol, results showed that trehalose addition did not have the same effect as in case of fruity esters. Initial amount of aroma compounds had high influence on number and amount of aroma compounds detected in samples, as well as on effect of trehalose on selected aroma compounds probably due to interactions of all compounds of the samples.

Keywords: aroma compounds, trehalose addition, strawberry cream filling

Introduction

Stability of aroma compounds in many different foods has been of increasing interest due to its relationship with the quality and acceptability of foods, but it is difficult to control it. Processing and storage, addition of different ingredients, and packaging materials, in foods often cause modifications of overall aroma by reducing aroma compound intensity or producing off-flavour components (Madene et al., 2006). Incorporation of small amounts of aroma compounds into foods can greatly influence the final product quality, cost and consumer satisfaction. The food industry is continuously developing new ingredients,

* Mirela.Kopjar@ptfos.hr

processing methods, and packaging materials to improve flavour preservation and delivery (Madene et al., 2006; Zeller and Salieb, 1996).

Addition of different additives, into the food products, can influence their physicochemical properties, aroma, texture and colour. Additionally, they can improve overall quality of food products since they interact with food compounds. According to many authors, carbohydrates are known to enclose volatile aroma compounds (Lovrić et al., 1978; Piližota et al., 1983; Saravacos, 1993; Komes et al., 2003; Komes et al., 2005; Komes et al., 2007), so, in this study influence of trehalose on aroma compounds was investigated. Trehalose (α,α -trehalose) is a disaccharide formed by α 1,1 linkage of two d-glucose molecules (Birch, 1963). It is a non-reducing sugar that is not easily hydrolysed by acid, and the glycosidic bond is not cleaved by α -glucosidase. The molecular formula and weight are $C_{12}H_{22}O_{11}$ and 342.31, respectively (Birch, 1963; Elbein, 1974). Due to its natural functions, mechanisms of action and technical qualities, trehalose could be applied in the food, cosmetic and medical industries (Colaço and Roser, 1995; Sugimoto, 1995). The only limiting factor to the generalised use of trehalose in the food industry was cost (Sugimoto, 1995). After development of a new manufacturing process, the production costs of trehalose were dramatically reduced. In the early 1990s the cost of 1 kg of commercialised trehalose could reach US\$ 700 (Paiva and Panek, 1996) but after development of enzymatic process of trehalose production price was reduced to 5–6 US\$ kg⁻¹ (Schiraldi et al., 2002). These production costs reductions led its use in a wide variety of cost sensitive applications, including foods. Trehalose has also been introduced commercially as an ingredient in the US by Cargill Health and Food Technologies, and is recognized as a GRAS material by the Food and Drug Administration. The remarkable ability of trehalose to completely protect cryptobiotic plants and animals from desiccation damage can be applied in drying foods on an industrial scale (Pszczola, 2002).

Strawberry is a very delicious fruit growing in nearly all the countries in the world. Because of its typical, very attractive aroma, strawberry has always been a favoured object in aroma analysis. Volatile components of strawberries have been extensively studied and more than 360 volatiles are assumed to be involved in strawberry aroma. A complex mixture of esters, aldehydes, alcohols and sulphur compounds mainly determines strawberry aroma, but esters are quantitatively and qualitatively the most important class of volatiles (Lovrić et al., 1978; Piližota et al., 1983; Komes et al., 2003; Kafkas et al., 2005).

Most food products are very complex matrices due to their chemical composition and structure. They are often multi-component materials and present several phases. Food products are composed of volatile and non-volatile constituents and interactions between those constituents strongly affect the quality of food products. Influence of trehalose addition on colour (Kopjar et al., 2008a, Duangmal et al., 2008), aroma (Kopjar et al., 2008a) and texture (Kopjar et al., 2008b) of some food products were already proven. The strawberry cream

filling is one of those food products. In previous article, Kopjar et al. (2008) showed that there was significant influence of trehalose addition and its amount on fruity esters content in evaporated and freeze-dried strawberry cream fillings. In this article broader insight of influence of trehalose addition and its amount on fruity esters, respectively, γ -decalactone and 2,5-dimethyl-4-hydroxy-3(2H)-furanone (furanol) was given and possible effect of initial amount of strawberry aroma compounds on final aroma profile of evaporated strawberry cream fillings was investigated.

Materials and Methods

Material

Raw material for preparation of strawberry cream fillings, without and with trehalose addition (3, 5 and 10 % as partial sucrose replacement), was obtained from food company Fructal d.d. (Ajdovščina, Slovenia) where ingredients (commercially frozen strawberry puree, starch, vegetable fat, sucrose, glucose syrup, sorbitol) were mixed together according to industrial recipe. The total solids of the mixture of ingredients were 40 %.

Sample preparation

Samples of strawberry cream fillings were prepared in the laboratory by evaporation of mixture of ingredients (40 % of total solids) until 76 % of total solids in samples were achieved. Evaporation was conducted with laboratory rotavapor (Büchi Rotavapor R-114, Switzerland) under the vacuum (Büchi Vac V-500 and Büchi Vacuum Controller B-721, Switzerland) at 80 °C. The pressure was gradually decreased until 30 mbar was achieved. The rotavapor was equipped with water bath (Büchi Watherbath B-480, Switzerland), which was used for controlling temperature. To achieve 76 % of total solids 1 hour and 40 minutes were needed.

Strawberry cream fillings were prepared without and with an addition of strawberry aroma (as it is prepared in industry). Aroma (2 %) was added after strawberry cream fillings preparation. Samples were homogenised by hand on metallic plate and left 10 days to stabilise at room temperature. Sampling for aroma compounds evaluation was conducted before addition of strawberry aroma and after 10 days of sample stabilisation.

Determination of aroma compounds

GC-MS analyses were carried out for evaluation of selected fruity esters (ethyl acetate, ethyl butanoate, 2 methyl-ethyl butanoate, 3 methyl-ethyl butanoate, ethyl pentanoate, methyl-ethyl pentanoate, ethyl hexanoate, methyl hexanoate,

methyl butanoate), γ -decalactone and 2,5-dimethyl-4-hydroxy-3(2H)-furanone. The extraction of volatiles was carried out with solid-phase microextraction (SPME) fiber 85 μ m Carboxen/PDMS (Supelco) at 50 °C for 40 min. For analyses, 6890N instrument (Agilent, SAD) equipped with MS 5971A detector (Hewlett Packard, SAD) was used. Compounds were analysed on a ZB-WAX column (60 m x 0.32 mm x 0.5 μ m, Phenomenex). The temperature program was as follows: 5 min at 40 °C, temperature gradient 4 °C/min, and final temperature 230 °C for 5 min. The carrier gas was helium with a flow rate of 1 mL/min at 40 °C. Desorption of adsorbed volatiles was carried out by exposing the fiber in the injector port of the GC at 270 °C for 5 min. For thermal desorption, the splitless injection mode was used and the split valve was opened after 0.5 min. Mass spectra were obtained with 70 eV electron impact ionisation, while the mass spectrometer was continuously scanning m/z 30–300. Determination of the analysed compounds was confirmed by retention times of single compounds and from bibliographic data. The results were expressed as total peak area. Analyses were conducted in triplicates.

Results and Discussion

In this study broader insight of trehalose influence on aroma compounds, selected fruity esters, γ -decalactone and furaneol, in strawberry cream fillings, is given. Also, possible influence of initial amount of aroma compounds on final aroma profile will be discussed.

Influence of trehalose addition

From the results of aroma compounds amount in strawberry cream fillings in evaporated samples without addition of strawberry aroma (Fig 1) it can be seen that trehalose addition and its amount had influence on aroma compounds in samples. Samples with addition of trehalose (as a partial sucrose replacement in strawberry cream filling) had higher amount of aroma compounds but there were some exceptions, such in the case of furaneol (all amount of trehalose), ethyl acetate (5 and 10 % of trehalose addition), ethyl butanoate and ethyl 2-methyl butanoate (10 % of trehalose addition). Amount of aroma compounds did not increase proportionally with increase of amount of trehalose, in some cases it was even detected reverse effect. Addition of 3 % of trehalose (sucrose replacement) caused higher retention of ethyl acetate and ethyl butanoate, while with further increase of trehalose addition decrease of amount of aroma compounds was observed and amount was even lower than in samples without trehalose addition. In the case of ethyl 2-methyl butanoate, addition of 3 % of trehalose caused the highest retention of this compound in samples. Addition of 5 % replacement of sucrose with trehalose still influenced retention of higher amount of this ester in contrast to samples with 10 % of sucrose replacement

with trehalose in which lower amount of this ester have been observed. There was slightly higher amount of γ -decalactone after addition of trehalose. Trehalose addition did not cause retention of furaneol. Actually, the content of furaneol was lower in the samples with trehalose addition and it did not change with increase of trehalose amount. The highest amount of furaneol was determined in the samples without trehalose addition.

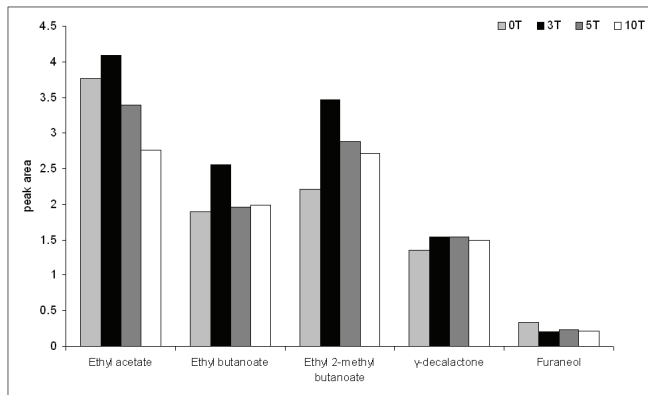

Fig. 1. Amount of aroma compounds in strawberry cream fillings without addition of aroma (T – trehalose)

Fig 2. presents results of determination of amount of aroma compounds with addition of strawberry aroma. In the case of samples with addition of strawberry aroma different tendency was observed. With addition of trehalose up to 5 % (sucrose replacement) the increase of an amount of ethyl acetate, ethyl butanoate, ethyl pentanoate and ethyl hexanoate was observed. After addition of 10 % of trehalose only increase of ethyl butanoate was observed, while all other esters exhibited decrease but still those amounts were higher than in samples without trehalose addition. Again, there was no proportional increase of fruity esters with increase of trehalose addition. Methyl hexanoate and methyl butanoate were not detected and it was evident that trehalose did not influenced their retention except in case of methyl hexanoate when 10 % of trehalose was added. For ethyl 2-methyl butanoate and ethyl 3-methyl butanoate it was observed that with addition of trehalose up to 5 % higher amount of those esters were obtained, while with 10 % of trehalose addition amount of esters slightly decreased. Addition of trehalose had also positive influence on retention of ethyl methyl pentanoate. With higher amounts of sucrose replacement, especially with 5 % of trehalose, there was higher influence of trehalose, but with lowest amount (3 %) of trehalose addition there was negligible influence. Regarding retention of, γ -decalactone and furaneol, addition of trehalose caused decrease of their amounts.

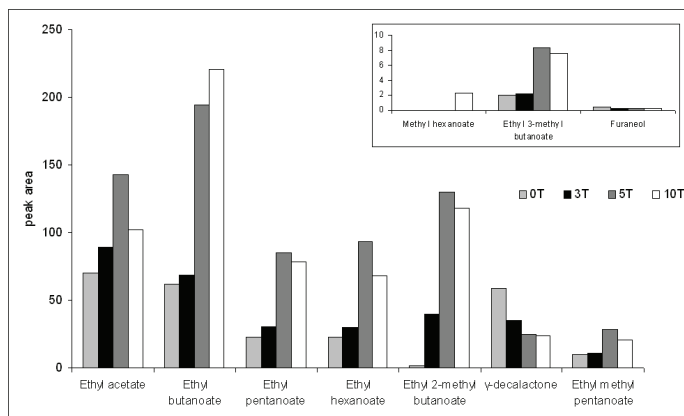

Fig. 2. Amount of aroma compounds in strawberry cream fillings with addition of aroma (T – trehalose)

From the results it can be seen that trehalose has double effect. In the case of investigated esters, except for ethyl methyl pentanoate, trehalose addition caused increase of aroma compounds while in the case of γ -decalactone and furaneol it caused decrease of this aroma compounds in samples. Also, it is very important to note that in some cases (ethyl 3-methyl butanoate, methyl butanoate and methyl hexanoate) aroma compounds were only detected when trehalose was added. This is one more proof that structure of aroma compounds and composition of food matrix is very important for retention of aroma compounds in food matrix.

Even if many authors tried to explain mechanisms of trehalose action, real mechanism is still not known, but there are three theories, that exist. Three theories that have been put forward to explain the mechanism of the action of trehalose are: 1) water replacement hypothesis, 2) glass transformation hypothesis and 3) chemical stability hypothesis (Colaço and Roser, 2005). After conducting our study, we do not want to point out just one theory but rather we would agree that combined effect of all three theories might be responsible for trehalose influence on retention of aroma compounds. The ability of sugar molecules to bind protectively onto the surface of molecular structures has been ascribed also to their ability to form hydrogen bonds, the so called »water replacement hypothesis«. Unlike most other disaccharides, trehalose has no direct internal hydrogen bonds. All four internal bonds are indirectly connected via the two water molecules, which form part of the native dihydrate structure. This arrangement gives to the molecule an unusual flexibility around the disaccharide bond, which may allow trehalose to fit more closely to the irregular surface of macromolecules than other, more rigid disaccharides, in which the rings are directly hydrogen bonded to each other. The well-known ability of

sugars to solidify as glass from solution rather than by crystallisation has also been suggested as an important element in the mechanism by which trehalose confers desiccation tolerance on cryptobionts. A further property of glass transition is to prevent the loss of small hydrophobic volatile esters during drying and storage, thus ensuring their release only after rewetting and dissolution of the glassy matrix. Unlike many other sugars that also undergo glass transition, trehalose produces glasses that are not hygroscopic (Colaço and Roser, 2005). Branca et al. (2000) pointed out that trehalose solutions in comparison to sucrose and maltose solutions, showed the smallest partial molar volume value, indicative of a more packed conformation, together with a greater partial volume increase with temperature, which indicates a greater structural sensitivity. In addition, the trehalose water system is characterized by the highest values of both the interaction strength parameter and of hydration number, supporting the hypothesis of a more packed conformation especially at the lowest temperatures. From a biological point of view, their finding could imply a greater ability of trehalose to encapsulate biomolecules in more rigid and packed structures and hence a greater bioprotector effectiveness of trehalose in respect to sucrose (Branca et al., 2000). Findings of Bordat et al. (2004) showed that trehalose water solution has superior effects in “destructuring” the network of water and in slowing down its dynamics in comparison of sucrose and maltose solutions. These two properties could play a key role in the understanding of the microscopic mechanisms of bioprotection. In their opinion their work also highlights the narrow links between the various hypotheses listed above, which are not fully satisfactory when taken individually.

Influence of strawberry aroma addition

As it was already mentioned above, and shown in our results, comparison of samples with native strawberry aroma (without addition of aroma) with result of samples with addition of strawberry aroma, after preparation, showed that there was influence of addition of aroma on its retention in complex strawberry cream filling matrix. Except the higher amount of aroma in samples, what was expected, there have been noted that there was different influence of trehalose addition. It is very important to have in mind that initial concentration of aroma compounds is very important and that samples with strawberry aroma addition have different trend than samples without aroma addition. It is not unlikely that the various compounds compete for binding sites when they are added as a mixture of compounds (Escher et al., 1999; Van Ruth and King, 2003). Arvisenet et al. (2002) investigated the retention of three aroma compounds (isoamyl acetate, ethyl hexanoate and linalool), in starch containing model food matrices, and found out that isoamyl acetate had little effect on the retention of linalool and ethyl hexanoate in a medium containing amylose. They observed that the retention of ethyl hexanoate was slightly improved (higher) in the presence of

linalool. They assumed that a competition phenomenon might occur at higher aroma compound concentrations when the free interhelical spaces of amylose become less important, thus they repeated experiment with higher concentrations first with ethyl hexanoate, than with linalool, and a competitive effect was observed. The higher the concentration of one aroma compound was, the less the second one was retained. For both aroma compounds, they observed a linear decrease of the retention with increasing concentration of the second aroma compound, but it was clear that the addition of linalool had far more influence on the retention of ethyl hexanoate than the opposite. The same authors also found out that in the waxy corn starch pastes, containing two aroma compounds in a blend, the presence of isoamyl acetate caused decrease of the retention of linalool and seemed to decrease also the retention of ethyl hexanoate. The opposite tendency was found out for ethyl hexanoate. The presence of this compound decreased the retention of isoamyl acetate. These two aroma compounds seemed to be in competition for amylopectin (Arvisenet et al., 2002). Rutschmann and Solms (1990) mentioned a possible cooperative effect: the formation of a complex with a first molecule favoured the formation of a complex with a second one. As consequence of previous studies, possible explanation for different behaviour of aroma compounds in samples without and with strawberry aroma addition could be competitive and cooperative effect of aroma compounds.

Conclusions

Formulation of food products is very important since composition of matrix strongly influence the quality properties of the foods. Retention of aroma compounds is very complex phenomena, as it can be seen from our results. It depends on matrix composition and interactions between volatile and non-volatile constituents of matrix, as well as preparation process since it can influence the structure of food matrix, which, of course, affects aroma compounds behaviour. The structure of aroma compounds and properties also strongly affects their retention, as well as initial concentration of aroma compounds, since it can lead to competitive and/or cooperative phenomena and through that, of course on retention or release of aroma compounds from food matrix.

Small modifications (like replacement of sucrose with trehalose and addition of strawberry aroma) of food matrix composition and preparation processes greatly affect retention of the aroma compounds in strawberry cream fillings probably due to change in interactions between ingredients in food matrix. Generally looking, addition of trehalose caused higher content of fruity esters, while on other two investigated aroma compounds had reverse effect. During formulation of food products, when one is trying to improve existing or develop new product, should have in mind influence of trehalose addition on other quality properties like colour and texture, since in our previous articles (Kopjar et al., 2008a; Kopjar et al. 2008b) we showed that trehalose has great impact on overall quality.

Acknowledgment

This work was supported by research on Croatian-Slovenian joint project and National Scientific Project financed by Croatian Ministry of Science, Education and Sports. We would like to thank to Fructal d.d. (Ajdovscina, Slovenia) for providing raw material for strawberry paste preparation. Also, we would like to thank scientists from Biotechnical Faculty, University of Ljubljana (Slovenia) for their assistance during this study.

References

- Arvisenet, G., Voilley, A., Cayot, N. (2002): Retention of aroma compounds in starch matrices: competitions between aroma compounds toward amylose and amylopectin, *J. Agric. Food Chem.* 50 (25), 7345-7349.
- Birch, G.G. (1963): Trehalose. In: *Advances in carbohydrate chemistry*, vol. 18. Academic Press: New York, pp. 201-225.
- Bordat, P., Lerbret, A., Demaret, J.-P., Affouard, F., Descamps, M. (2004): Comparative study of trehalose, sucrose and maltose in water solutions by molecular modelling, *Europhys. Lett.* 65 (1), 41-47.
- Branca, C., Magazù, S., Maisano, G., Migliardo, P. (2000): Experimental study of the hydration properties of homologous disaccharides, *J. Biol. Phys.* 26 (4), 295-306.
- Colaço, C.A.L.S., Roser, B. (1995): Trehalose - a multifunctional additive for food preservation. In: *Food packaging and preservation*. Blackie Professional, London, UK, pp. 123-140.
- Duangmal, K., Saicheua, B., Sueeprasan S. (2008): Colour evaluation of freeze-dried roselle extract as a natural food colorant in a model system of a drink, *LWT* 41(8), 1437-1445.
- Elbein, A.D. (1974): The metabolism of α,α -trehalose. In: *Advances in carbohydrate chemistry and biochemistry*, vol. 30. Academic Press, New York, USA, pp. 227-256.
- Escher, F.E., Nuessli, J., Conde-Petit, B. (1999): Interactions of flavor compounds with starch in food processing. In: *Flavor release*. New Orleans, Louisiana, USA, pp. 230-245.
- Kafkas, E., Kafkas, S., Margery Kochen-Dean, M., Schwab, W., Larkov, O., Lavid, N., Bar, E., Ravid, U., Lewinson, E. (2005): Comparison of methodologies for the identification of aroma compounds in strawberry, *Turk. J. Agric. For.* 29 (5), 383-390.
- Komes, D., Lovrić, T., Kovačević Ganić, K., Gracin, L. (2003): Study of trehalose addition on aroma retention in dehydrated strawberry puree, *Food Tech. Biotech.* 41 (2), 111-119.
- Komes, D., Lovrić, T., Kovačević Ganić, K., Gajdos Kljusurić, J., Banović, M. (2005): Trehalose improves flavour retention in dehydrated apricot puree, *Int. J. Food Sci. Tech.* 40 (4), 425-435.
- Komes, D., Lovrić, T., Kovačević Ganić, K. (2007): Aroma of dehydrated pear products, *LWT* 40 (9), 1578-1586.

Topic: Food technology and biotechnology

- Kopjar, M., Piližota, V., Hribar, J., Simčič, M., Zlatič, E., Nedić Tiban, N. (2008a): Influence of trehalose addition and storage conditions on the quality of strawberry cream filling, *J. Food Eng.* 87 (3), 341-350.
- Kopjar, M., Piližota, V., Hribar, J., Nedić Tiban, N., Šubarić, D., Babić, J., Požrl, T. (2008b): Influence of trehalose addition on instrumental textural properties of strawberry pastes, *Int. J. Food Prop.* 11 (3), 646-655.
- Lovrić, T., Piližota, V., Abramović, G. (1978): Utjecaj dodatka šećera na neka svojstva kvalitete liofilizirane kaše od jagode (Influence of sugar addition on the quality of lyophilized strawberry squash), *Prehrambeno-tehnološka revija* 16, 76-80.
- Madene, A., Jacquot, M., Scher, J., Desobry, S. (2006): Flavour encapsulation and controlled release. Review, *Int. J. Food Sci. Tech.* 41 (1), 1–21.
- Piližota, V., Lovrić, T., Abramović, G. (1983): Utjecaj dodatka šećera i debljine sloja (materijala) na zadržavanje sastojaka arome kod liofilizacije kaše jagode i kupine (Influence of sugar addition and thickness of layer of food material on aroma compounds retention in lyophilized strawberry and blackberry squash), *Kemija u industriji* 10, 507-514.
- Paiva, C.L.A.; Panek, A.D. (1996): Biotechnological applications of the disaccharide trehalose. *Biotech. Annual Rev.*, 2, 293–314.
- Pszczola, D.E. (2002): Exploring novel flavor and health concepts on the west coast front, *Food Tech.* 54 (5), 39–40.
- Rutschmann, M.A., Solms, J. (1990): Formation of inclusion complexes of starch with different organic compounds. III. Study of ligand binding in binary model systems with (-) limonene, *LWT* 23, 80-83.
- Saravacos, G.D. (1993): Technological developments in fruit and vegetable dehydration, In: Food flavor, ingredients and composition. Elsevier, New York, USA, pp. 389-404.
- Schiraldi, C., Di Lernia, I., De Rosa, M. (2002): Trehalose production: exploiting novel approaches, *Trends in Biotech.* 20 (10), 420–425.
- Sugimoto, T. (1995): Production of trehalose by enzymatic starch saccharification and its applications, *Shokuhin Kogyo (Food Industry)* 38: 34–39.
- Van Ruth, S.M., King, C. (2003): Effect of starch and amylopectin concentrations on volatile flavour release from aqueous model food systems, *Flavour Frag. J.* 18 (5), 407–416.
- Zeller, B.L., Salleb, F.Z. (1996): Production of microporous sugars for adsorption of volatile flavours, *J. Food Sci.* 61 (4), 749–759.

Cryoprotective effect of maltose on chicken myofibrillar proteins (CMP)

UDC: 637.5'65 : 543.5

D. Kovačević, K. Mastanjević*, K. Suman

University of Josip Juraj Strossmayer in Osijek, Faculty of Food Technology Osijek, Franje Kuhača 20, 31000 Osijek, Croatia

Summary

The cryoprotective effects of maltose on chicken myofibrillar proteins (CMP) were investigated. CMP were produced from broiler mixed with different mass fraction of maltose ($w = 0 - 10 \%$), frozen and stored for 30 days on $-30 \text{ }^{\circ}\text{C}$. Myofibrillar protein functional stability was monitored by salt extractable protein (SEP) and differential scanning calorimetry (DSC). Salt extractable protein (SEP) showed that the addition of maltose caused smaller decrease in protein solubility after 30 days of frozen storage. Peak thermal transition temperatures (T_p) and denaturation enthalpy (ΔH) of myofibrillar proteins were evaluated. Differential scanning calorimetry (DSC) revealed a shift in peak thermal transition temperature (T_p) of myosin and actin to higher temperature as the mass fraction of maltose increases. After 30 days of frozen storage transitions enthalpies (ΔH) of myosin and actin of CMP samples showed increase with the increase of mass fraction of maltose. Since the value of denaturation enthalpy is directly related to amount of native proteins, higher values of ΔH indicates to the higher cryoprotective effects of maltose on chicken myofibrillar proteins.

Keywords: thermal transitions temperatures, cryoprotection, maltose chicken myofibrillar proteins, DSC, SEP

Introduction

Washed chicken meat is surimi-like product made from chicken meat. The process for making surimi-like product from chicken, with modified technology from fish surimi (Dawson et al., 1996) results in semi-purified protein fraction containing a high concentration of myofibrillar proteins. Freezing has become one of the most frequently used preservation method for meat and meat products. To protect myofibrillar proteins from freeze-denaturation and during frozen storage and maintain its possible high processability, cryoprotectants, such as disaccharides, polysaccharides, polyalcohol's, acids, polyphosphates are generally added (Park et al., 1988; MacDonald and Lanier 1991). Most commonly used instrumental methods for determination cryoprotective effects of added substances are measurement of myofibrillar protein solubility SEP (Salt

* kresimir.mastanjevic@ptfos.hr

extractable protein)(Sych et al., 1990), Ca²⁺ATP-ase activity, unfrozen water by Nuclear Magnet Resonance (NMR), and transition temperatures and enthalpy of myofibrillar proteins by Differential scanning calorimetry (DSC) (Sych et al., 1990; Yang and Froning 1994; Kijowski and Richardson 1996; Stangierski and Kijowski 2008).

Maltose (D-glucopyranosyl- α (1 \rightarrow 4)-D-glucopyranoside) is a reducing disaccharide. It has been found to have protective effect against thermal inactivation of enzymes (Kawai and Suzuki 2007) and freeze draying of microorganisms (Hamoudi et al., 2007).

The purpose of this work is to investigate with differential scanning calorimetry (DSC) and measurement of myofibrillar protein solubility SEP (Salt extractable protein) cryoprotective effects of maltose on chicken myofibrillar proteins (CMP).

Material and Methods

Samples of CMP were prepared in the laboratory from broiler (mainly *Pectoralis major M.* and *Pectoralis minor M.*) by the procedure of Yang and Froning (Yang and Froning 1992) with modifications. Instead, tap water, distilled water was used for washing and leaching. Samples were mixed with maltose ($w = 0 - 10\%$). Mass fractions were determined as percent of total mass. The pH level was measured in a homogenate of the sample with distilled water (1:10, p/v) with pH/Ion 510 – Bench pH/Ion/mV Meter (Eutech Instruments Pte Ltd/ Oakton Instruments, USA). Water activity (a_w) was determined using a Rotronic Hygrolab 3 (Rotronic AG, Bassersdorf, Switzerland) at room temperature (20 ± 2 °C). The FoodScan Meat Analyser was used to determine moisture, total protein and total fat according to the AOAC 2007. 04. (2007). Samples were packed in polyethylene bags, frozen, and stored at -30 °C. Denaturation due to freezing was evaluated after 30 days by salt extractable protein (SEP) and differential scanning calorimetry (DSC) analysis.

Salt soluble proteins (SEP)

Soluble proteins were extracted by the procedure of Li and Wick 2001 (Li and Wick 2001), with modifications. Sample of mass 1 g with 6 ml standard brine STB solution, was mixed with a vortex mixer (Vibromix 10, Tehnica, Slovenia) at 4 °C for 30 min. The salt soluble proteins were recovered in the supernatant following centrifugation at $10\,000 \times g$, 4 °C, 15 min in a Heraeus Multifuge 3L-R. The Bio-Rad Protein Assay (Bio-Rad Laboratories) was used to estimate protein concentration in the resulting supernatants using bovine albumin as a protein standard. Salt extractable protein (SEP) was expressed as the concentration of salt extractable protein (mg ml^{-1}), estimated by Bio-Rad analysis.

DSC measurements

Differential scanning calorimetry (DSC) was performed with Mettler Toledo DSC 822^e differential scanning calorimeter equipped with STAR^e software. Samples of cca. 15 mg (± 1 mg) were weighed and sealed into standard aluminium pans (40 μ l) and scanned over the range from 25 to 95 °C at the heating rate of 10 °C min⁻¹, using empty standard aluminium pan as a reference. The onset (T_o), peak (T_p) and endset (T_e) temperatures were determined from DSC curves. The changes in enthalpy (ΔH J g⁻¹), associated with the denaturation of proteins, were determined by measuring the area under the DSC curves using STAR^e software. Denaturation enthalpies (ΔH), were expressed on the total mass fraction of protein.

Statistical analysis

Three determinations for basic chemical composition, pH, a_w , onset (T_o), peak (T_p) and endset (T_e) temperatures, denaturation enthalpies (ΔH) and SEP were measured for each sample. Experimental data were analyzed by the analysis of variance (ANOVA) and Fisher's least significant difference (LSD), with significance defined at $p < 0.05$. Statistical analysis was carried out with Statistica ver. 7.0 StatSoft Inc. Tulsa, OK, USA.

Results and Discussion

The average basic chemical composition, pH and a_w values of individual samples of CMP did not vary significantly and amounted to 86.17 % \pm 0.58 water, 13.06 % \pm 0.58 protein, 0.73 % \pm 0.07 fat, 6.95 \pm 0.04 pH and 0.98 \pm 0.01 a_w .

Salt soluble proteins (SEP)

Myofibrillar protein denaturation during storage in the frozen state expressed by the loss of protein solubility during is a result of formation of hydrogen or hydrophobic bonds, as well as disulfide bonds and ionic interaction (Sych et al., 1990, MacDonald and Lanier 1991, Auh et al., 1999). The salt extractable protein (SEP) of CMP mixed with maltose ($w = 0 - 10$ %) after 30 days of frozen storage at -30 °C are shown in Table 1. The highest values of SEP had a sample mixed with 10 % of maltose, and lowest the CMP sample without addition of maltose. SEP concentrations of CMP varied significantly ($p < 0.05$) with addition of maltose. The increase of SEP values with increase of mass fraction of maltose indicated possible cryoprotection effects of maltose on CMP.

Table 1. Salt extractable protein SEP (mgml⁻¹) of CMP as a function of mass fraction of maltose ($w = 0 - 10\%$) after 30 days of frozen storage.

w (%)	SEP (mg ml ⁻¹)
0	3.38 ^a ± 0.14
2	4.72 ^b ± 0.04
4	4.85 ^{bc} ± 0.03
6	4.94 ^b ± 0.02
8	5.30 ^c ± 0.05
10	5.52 ^c ± 0.39

Values are means ±SD of triplicate.
Values in the same row with different superscripts a-f and are significantly different ($p < 0.05$).

Differential scanning calorimetry

Differential scanning calorimetry thermogram's of CMP mixed with maltose after 30 days of storage at $-30\text{ }^{\circ}\text{C}$ are presented in Fig. 1.

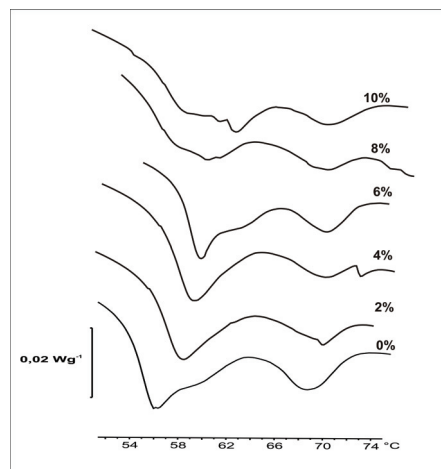

Fig. 1. DSC thermograms of CMP stored for 30 days at $-30\text{ }^{\circ}\text{C}$ as a function of mass fraction of maltose ($w = 0 - 10\%$)

CMP thermograms normally contained two endothermic transitions. Referring to previous DSC studies of similar samples (Kijowski and Richardson 1996; Fernandez-Martin 2007) it can be assumed that the two peaks are related to the thermal denaturation of myosin and actin. Onset (T_o), peak (T_p) and endset (T_e) of myosin and actin for CMP mixed with maltose

after 30 days of frozen storage are presented in Tables 2 and 3. Values of the peak thermal temperatures (T_p) of myosin and actin were different then values of raw chicken breast meat reported by Kijowski and Mast (1988), Murphy et al., (1998) and Bircan and Barringer (2002). Similar results were reported by Yang and Froning (1994) and Kijowski and Richardson (1996) for washed mechanically deboned poultry meat, this could be explained by concentration of myofibrillar protein by washing and different pH and ionic environment when compared to the raw state of muscle (Lesiow and Xiong 2001). Analysis of variance showed that myosin's T_o , T_p and T_e varied significantly ($p < 0.05$) as a function of mass fraction of maltose (Table 2). Shifts in T_p of myosin to the higher values as the mass fraction of maltose increases can be interpreted as a stabilization of myofibrillar proteins since a higher temperature was required to denature these proteins (Sych et al., 1991; Herrera et al., 2001). Highest values of T_p of myosin shows the samples of CMP mixed with 10 % of maltose. T_p of actin transitions vary significantly ($p < 0.05$) with addition of maltose (Table 3). T_p of myosin shows higher shift by increase of mass fraction of maltose then a T_p of actin for all samples (Table 2 and 3) (Sych et al., 1990). The method of expressing peak enthalpies ΔH was adopted to provide an estimate of the quantity of native proteins. Enthalpies of myosin and actin transitions for CMP samples with addition of maltose, after 30 days of frozen storage, are shown in Tables 2 and 3. Values of ΔH for myosin and actin showed increase with the increase of mass fraction of maltose, which is in agreement with the results reported by Stangierski and Kijowski (2008). The highest values of transition enthalpies showed samples mixed with 10 % of maltose. ΔH for myosin varied significantly ($p < 0.05$) as a function of mass fraction of maltose (Table 2). For actin, ΔH also varied significantly ($p < 0.05$) as a function of mass fraction of maltose (Table 3).

Results of these study presented indicate that is possible to reduce negative effects of frozen storage on the functional properties of chicken myofibrillar proteins by addition of maltose.

Table 2. Values of transitions temperatures (T_o , T_p , T_e) and denaturation enthalpies (ΔH) of CMP myosin mixed with different mass fractions of maltose ($w = 0 - 10$ %)

w (%)	T_o (°C)	T_p (°C)	T_e (°C)	ΔH (J g ⁻¹)
0	50.05 ^a ± 0.09	55.38 ^a ± 0.03	60.39 ^a ± 0.05	4.01 ^a ± 0.02
2	50.43 ^a ± 0.60	55.77 ^b ± 0.15	60.46 ^a ± 0.21	4.16 ^a ± 0.01
4	51.62 ^b ± 0.36	56.25 ^c ± 0.06	61.14 ^b ± 0.10	4.22 ^b ± 0.03
6	52.13 ^{bc} ± 0.09	56.77 ^d ± 0.11	61.50 ^c ± 0.16	4.76 ^c ± 0.05
8	52.63 ^c ± 0.27	57.66 ^e ± 0.19	61.92 ^d ± 0.13	4.91 ^d ± 0.06
10	53.50 ^d ± 0.20	58.41 ^f ± 0.17	62.54 ^e ± 0.19	5.75 ^e ± 0.02

Values are means ±SD of triplicate. Values in the same row with different superscripts a-f and are significantly different ($p < 0.05$).

Table 3. Values of transitions temperatures (T_o , T_p , T_c) and denaturation enthalpies (ΔH) of CMP actin mixed with different mass fractions of maltose ($w = 0 - 10\%$)

w (%)	T_o (°C)	T_p (°C)	T_c (°C)	ΔH (J g ⁻¹)
0	66.23 ^a ± 0.04	70.73 ^a ± 0.11	71.87 ^a ± 0.04	1.21 ^a ± 0.01
2	66.87 ^b ± 0.13	71.05 ^b ± 0.10	72.15 ^a ± 0.16	1.25 ^a ± 0.05
4	67.43 ^c ± 0.15	71.47 ^c ± 0.14	72.97 ^b ± 0.16	1.55 ^b ± 0.04
6	67.92 ^d ± 0.13	71.87 ^d ± 0.10	73.47 ^c ± 0.20	1.70 ^c ± 0.03
8	68.48 ^e ± 0.06	72.72 ^e ± 0.14	73.86 ^d ± 0.07	1.74 ^d ± 0.02
10	68.83 ^f ± 0.11	73.55 ^e ± 0.16	74.95 ^e ± 0.16	1.82 ^e ± 0.04

Values are means ±SD of triplicate. Values in the same row with different superscripts a-f and are significantly different ($p < 0.05$).

Conclusions

The smaller loss of myofibrillar protein solubility, the shift in thermal transition temperature of myosin and actin to higher temperature and increase of enthalpies of myosin and actin transition as the mass fraction of maltose increases, approve that maltose was acting according to the cryoprotecting mechanism and interacted with chicken myofibrillar proteins.

References

- AOAC.2007. Official methods of analysis 18th edn, Association of Official Analytical Chemists. Gaithersburg, MD
- Auh, J.H., Lee, H.G., Kim, J.W., Kim, J.C., Yoon, H.S., Park, K.H. (1999): Highly concentrated branched oligosaccharides as cryoprotectant for surimi, *J. Food Sci.* 64, 418-422.
- Bircan, C., Barringer, S.A. (2002): Determination of protein denaturation of muscle foods using the dielectric properties, *J. Food. Sci.* 67, 202-205.
- Dawson, P.L., Sheldon, B.W., Ball, H.R. (1988): Extraction of Lipid and Pigment Components from Mechanically Deboned Chicken Meat, *J. Food. Sci.* 53, 1615-1617.
- Fernandez-Martin, F. (2007): Bird muscles under hydrostatic high-pressure/temperature combinations - A DSC evaluation, *J. Therm. Anal.* 87, 285-290.
- Hamoudi, L., Goulet, J., Ratti C. (2007): Effect of protective agents on the viability of *Geotrichum candidum* during freeze-drying and storage, *J. Food. Sci.* 72, 45-49.
- Herrera, J.J., Pastoriza, L., Sampedro, G. (2001): A DSC study on the effects of various maltodextrins and sucrose on protein changes in frozen-stored minced blue whiting muscle, *J. Sci. Food Aric.* 81, 377-384.
- Kawai, K., Suzuki T. (2007): Stabilizing effect of four types of disaccharide on the enzymatic activity of freeze-dried lactate dehydrogenase: Step by step evaluation from freezing to storage. *Pharm Res.* 24, 1883-1890.

Topic: Food technology and biotechnology

- Kijowski, J., Richardson, R.I. (1996): The effect of cryoprotectants during freezing or freeze drying upon properties of washed mechanically recovered broiler meat, *Int. J. Food Sci. Technol.* 31, 45-54.
- Kijowski, J.M., Mast, M.G. (1988): Thermal-Properties of Proteins in Chicken Broiler Tissues, *J. Food. Sci.* 53, 363-366.
- Lesiow, T., Xiong, Y.L.L. (2001): Mechanism of rheological changes in poultry myofibrillar proteins during gelation, *Avian Poult. Biol. Rev.* 12, 137-149.
- Li, C.T., Wick, M. (2001): Improvement of the physicochemical properties of pale soft and exudative (PSE) pork meat products with an extract from mechanically deboned turkey meat (MDTM), *Meat Sci.* 58, 189-195.
- MacDonald, G.A., Lanier, T. (1991): Carbohydrates As Cryoprotectants for Meats and Surimi, *Food Technol.* 45, 150-159.
- Stangierski, J., Kijowski, J. (2008): Effect of selected substances on the properties of frozen myofibril preparation obtained from mechanically recovered poultry meat, *Eur. Food Res. Technol.* 226, 1415-1429.
- Sych, J., Lacroix, C., Adambounou, L.T., Castaigne, F. (1990): Cryoprotective Effects of Lactitol, Palatinit and Polydextrose on Cod Surimi Proteins During Frozen Storage, *J. Food Sci.* 55, 356-360.
- Sych, J., Lacroix, C., Carrier, M. (1991). Determination of Optimal Level of Lactitol for Surimi, *J. Food Sci.* 56, 285-290.
- Yang, T.S., Froning, G.W. (1992): Changes in Myofibrillar Protein and Collagen Content of Mechanically Deboned Chicken Meat Due to Washing and Screening, *Poultry Sci.* 71, 1221-1227.

Bioactive potential of herbal infusions prepared from traditional medicinal plants

UDC: 633.88 : 615.85

I. Ljubičić, A. Legac, A. Belščak-Cvitanović,
D. Horžić, F. Dujmić, D. Komes*

University of Zagreb, Faculty of Food Technology and Biotechnology, Department of Food Engineering, Pierottijeva 6, 10000 Zagreb, Croatia

Summary

The aim of this study was to evaluate the polyphenolic compounds and antioxidant properties of 10 medicinal plants prepared as infusions. The content of total phenols, flavonoids, flavan-3-ols and tannins of herbal infusions of lemon balm (*Melissa officinalis* L.), thyme (*Thymus serpyllum* L.), mint (*Mentha piperita* L.), nettle (*Urtica dioica* L.), blackberry leaf (*Rubus fruticosus*), olive leaf (*Olea europaea*), chamomille (*Matricaria recutita* L.), yarrow (*Achillea millefolium* L.), black locust (*Acacia pseudorobinia*) and horsetail (*Equisetum arvense*) were evaluated quantitatively by using UV/Vis spectrophotometric methods. Antioxidant capacity of herbal infusions was evaluated by using the ABTS (2,2'-azino-bis(3-ethylbenzthiazoline-6-sulphonic acid) and FRAP (ferric reducing/antioxidant power) assays. The highest content of total phenols was found in the infusion prepared from the leaves of lemon balm, followed by infusion made from mint, while the infusion prepared from the flowers of camomile contained the lowest phenolic content. Linden infusion was characterized with the highest flavan-3-ols content, while the raspberry leaf infusion exhibited the highest tannin content, which is in accordance with the results obtained by previous findings of other authors. The ranking of herbal infusions based on their decreasing antioxidant potential corresponds to the one obtained for the total phenol content, which is confirmed by a high correlation obtained between the results, pointing out to the fact that the phenolic compounds are responsible for the antioxidant capacity of herbal infusions.

Keywords: antioxidant capacity, herbal infusions, polyphenols, tannins

Introduction

Naturally derived antioxidants, especially polyphenols, currently present the main focus of scientific community, due to their excellent antioxidant properties, which makes the consumption of foods rich in these compounds highly recommended. In addition, the interest in chemical composition of medicinal herb products is growing because of ongoing developments in nutrition and in biochemical surveying and prospecting (Rodushkin et al., 1999). A wide array of positive health effects has been ascribed to plant polyphenols, such as their

* dkomes@pbf.hr

ability to protect against cancer and cardiovascular diseases, as well as their antimicrobial, antiinflammatory and anticariogenic properties. Although significant attention has been paid to the antioxidant capacity of polyphenols present in green tea and medicinal herbs and spices, it is much less known that leaf tissues of some common plants and spices, traditionally used in folk medicine, also possess a high content of these beneficial bioactive compounds. Traditional medicine plays an important role in the general state of health of a population. As more natural remedies are being commercialised, there is a need for scientifically accurate overview of their composition and activities. Herbal supplements are sold in the form of pills, capsules, liquids and creams, but the recent trend has been to take these herbal supplements as „tea“, the common name given to herbal infusions (Mellgren, 2001).

In Europe, tea makers have witnessed a shift in sales from black tea to aromatic and healthy alternatives, such as herbal infusions, which resulted with the increase in herbal infusion consumption by almost 50 % from 1997 to 2002 (Gallaher et al., 2006). In spite of the dramatic rise in sales of herbal infusions world-wide in recent years, there is a general lack of data regarding the composition of herbs and herbal infusions. Because many people are now consuming these herbal supplements, it is important to understand their nutrient composition as well as their effect on human health.

There are many medicinal plants used in the Croatian traditional medicine and diet. Among them, the plants listed in Table 1 are the most usually prepared and consumed as herbal teas. The wide spectrum of their beneficial activities listed in Table 1, are also attributed to the presence of polyphenolic compounds and their antioxidant properties. Therefore, the aim of this study was to determine the content of polyphenolic compounds and antioxidant capacity of herbal infusions of 10 traditionally used herbal species in order to provide an insight in the levels of polyphenolic antioxidants that are assured by consuming a cup of herbal infusion.

Materials and methods

Chemicals

Folin-Ciocalteu, formic acid, potassium peroxodisulfate, sodium carbonate, formaldehyde and hydrochloric acid were of analytical grade and supplied by Kemika (Zagreb, Croatia). Methanol (HPLC grade) was supplied by J.T.Baker (Deventer, Netherlands). Vanillin, Trolox (6-hydroxy-2,5,7,8-tetramethylchromane-2-carboxylic acid), ABTS (2,2'-azino-bis(3-ethylbenzthiazoline-6-sulphonic acid)diammonium salt) as well as gallic acid and tannic acid were obtained from Sigma-Aldrich (Steinheim, Germany).

Table 1. Details of the plant species analyzed in this study and their medicinal purposes

Common Name	Latin name	Family	Indications
Lemon balm	<i>Melissa officinalis</i> L.	<i>Lamiaceae</i>	Gastrointestinal disturbances, functional dyspepsia, nervous and sleeping disorders, sedative and spasmolytic actions (Bruneton, 1999)
Mint	<i>Mentha piperita</i> L.	<i>Lamiaceae</i>	Treats digestive disorders, spastic problems, ailments of the gall bladder and bile duct and catarrhs of the respiratory tract (van Myk and Wink, 2004)
Blackberry leaves	<i>Rubus fruticosus</i> L.	<i>Rosaceae</i>	Protection against endothelial dysfunction and vascular failure <i>in-vitro</i> ; cytotoxic effects on human oral, prostate, lung cancer cells (Serraino et al., 2003; Feng et al., 2004; Seeram et al., 2006)
Thyme	<i>Thymus serpyllum</i> L.	<i>Lamiaceae</i>	Dyspepsia, gastrointestinal disturbances, cough due to cold, whooping cough, bronchitis, laryngitis and tonsillitis, antimicrobial, bronchospasmolytic, an expectorant (Bruneton, 1999)
Yarrow	<i>Achillea millefolium</i> L.	<i>Asteraceae</i>	Treats arthritis, fever, the common cold and hypertension, lack of appetite and minor dyspeptic complaints (van Myk and Wink, 2004)
Horsetail	<i>Equisetum arvense</i> L.	<i>Equisetaceae</i>	Diuretic, treats inflammations of the lower urinary tract, kidney gravel and post-traumatic and static oedema, for healing wounds and other skin disorders (van Myk and Wink, 2004)
Nettle	<i>Urtica dioica</i> L.	<i>Urticaceae</i>	Antioxidant, anti-inflammatory, immune-suppressive antirheumatoid (rheumatic arthritis) and other inflammatory diseases (Broer and Behnke, 2002; Teucher, Obertreis, Rutkowski and Schmitz, 1996)
Black locust	<i>Acacia pseudorobinia</i> L.	<i>Fabaceae</i>	Calms stomach aches, hyperacid gastritis, distensions, eliminates coughs and hoarseness, remedy against asthma and bronchitis and headaches (van Myk and Wink, 2004)
Chamomille	<i>Matricaria recutita</i> L.	<i>Asteraceae</i>	Treats inflammations of the skin, mucosa and other skin disorders, internally against flatulent nervous dyspepsia, gastritis, diarrhoea, travel sickness, anxiety (van Myk and Wink, 2004)
Olive leaves	<i>Olea europea</i> L.	<i>Oleaceae</i>	Antihypertensive, diuretic, hypoglycaemic, antipyretic and antispasmodic activities (van Myk and Wink, 2004)

Sample preparation

Dried plant materials of lemon balm (*Melissae folium*), thyme (*Serpylli herba*), mint (*Menthae piperitae folium*), blackberry (*Rubi fruticosi folium*), horsetail (*Equiseti herba*), yarrow (*Millefolii herba*), olive leaves (*Oleae folium*) and nettle (*Urticae folium*), chamomile (*Matricariae flos*), black locust (*Acaciae herba*) were purchased at a local medicinal market. Extraction was carried out by pouring 200 mL of boiled distilled water over the plant samples (2 g) at room temperature. After extraction (5 min), the infusions were filtered through a tea strainer.

Determination of total phenol (TPC) and flavonoid content (TFC)

Total phenol content of herbal infusions was determined spectrophotometrically according to a modified method of Lachman et al. (1998). Briefly, 0.5 mL of the sample was pipetted into a 50 mL volumetric flask containing 2.5 mL of Folin-Ciocalteu's reagent, 30 mL of distilled water and 7.5 mL of 20 % water solution of Na₂CO₃, and the volume was made up with distilled water. After 2 h the absorbance was measured at 765 nm against a blank sample. To determine the content of total flavonoids (TFC), these compounds were precipitated using formaldehyde, which reacts with C-6 or C-8 atoms of 5,7-dihydroxy flavonoids to form methyl derivatives that further react with other flavonoid compounds also at C-6 and C-8 positions. The condensed products of these reactions were removed by filtration and the remaining non-flavonoid phenols were determined as previously described. Flavonoid content was calculated as the difference between total phenol and non-flavonoid phenols content. Gallic acid was used as the standard and the results were expressed as mg/L gallic acid equivalents (GAE) (Kramling and Singleton, 1969). All measurements were performed in triplicate.

Determination of flavan-3-ol content by the Vanillin assay

Herbal infusions were analyzed for their flavan-3-ol content using a method described by Di Stefano et al. (1989). Briefly, a volume of 500 µL of extract was added to 3 mL of the freshly prepared vanillin reagent (4 % methanolic solution) and after 5 min 1.5 mL of concentrated HCl was added. After incubation of 15 min in a cold water bath absorbance of the sample was measured at 500 nm against a blank sample. The blank sample was prepared by replacing the 4 % vanillin solution with methanol. Absorbance of the blank sample was subtracted from the absorbance of the corresponding vanillin-containing sample (ΔE). The content of flavan-3-ols was calculated according to the formula: (+)-catechin = $290.8 \times \Delta E$, and the results were expressed as mg (+)-catechin/L.

Determination of tannin content

The content of tannins was determined according to a procedure described by Schneider (1976). A volume of 2 mL of plant extract was mixed with 8 mL of water and 10 mL of acetate buffer. The mixture prepared in such a way represents the solution 1 (S1). A volume of 10 mL of the solution S1 was shaken with 50 mg of casein during 60 minutes and then filtered. This filtrate represents the solution S2. A quantity of 1 mL of each, solution S1 and S2, was mixed separately with 0.5 mL of Folin-Ciocalteu reagent and then both solutions were diluted to 10 mL with 33 % sodium carbonate decahydrate solution. The absorbance of such prepared solutions was measured against a blank sample at 720 nm. The content of tannins was evaluated upon three independent analyses. Absorbance values obtained for S1 correspond to total polyphenol content. Differences between absorbances of S1 and S2 correspond to content of casein-adsorbed tannins in plant samples. The content of tannins was expressed as percentage toward the mass of dry plant material.

Determination of antioxidant capacity of herbal infusions

Ferric Reducing/Antioxidant Power

The ferric reducing/antioxidant power (FRAP) assay was carried out according to a standard procedure by Benzie and Strain (1996). All measurements were performed in triplicate. Aqueous solutions of $\text{FeSO}_4 \times 7\text{H}_2\text{O}$ (100-1000 μM) were used for the calibration curve and the results are expressed as mM Fe(II).

Free radical scavenging assay

The Trolox equivalent antioxidant capacity (TEAC) of herbal infusions was estimated by the ABTS radical cation decolorization assay (Re et al., 1999). Trolox (6-hydroxy-2,5,7,8-tetramethylchromane-2-carboxylic acid), a water soluble vitamin E analogue, was used as a standard. The results, obtained from triplicate analyses, were expressed as Trolox equivalents, and derived from a calibration curve determined for Trolox (100-1000 μM).

Statistical analysis

All measurements and analyses were carried out in triplicate. The results were analyzed statistically using the Statistica 7.0 program to determine the average value and standard error. Variance analysis, with a significance level of $\alpha=0.05$ %, was performed in order to establish the differences in the content of polyphenolic compounds among the herbal infusions. Correlation analysis was also run with the same statistical package.

Results and discussion

According to the results of this study, the infusion of lemon balm (709.44 mg GAE/L) prepared by simulating the ordinary household tea preparation, provides the highest intake of total phenols among the analyzed herbal infusions, followed by the infusions of mint (515.83 mg GAE/L) and blackberry leaves (480.28 mg GAE/L), while olive leaf infusion (88.67 mg GAE/L) provides the lowest content of these beneficial compounds.

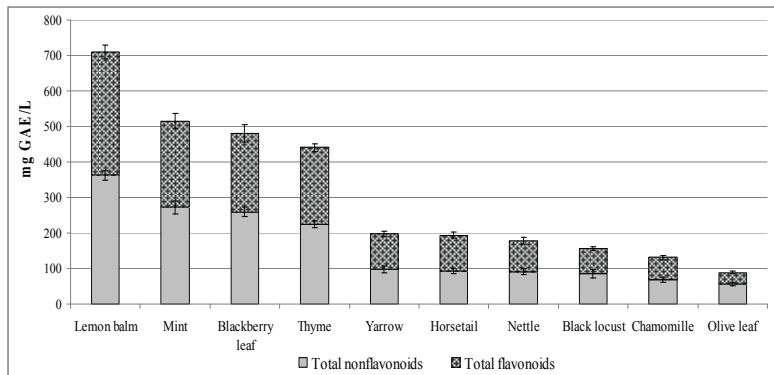

Fig. 1. Total phenol content (TPC) of herbal infusions

As can be seen on Fig.1 the plants of the Lamiaceae family (lemon balm, mint and thyme) and blackberry leaves are characterized with the highest content of polyphenolic compounds, which is in accordance with the results of Katalinić et al. (2006), who also confirmed the prevalence of these herbal species based on their polyphenolic content. Among the numerous herbal species prepared and consumed as herbal infusions, lemon balm is the predominant source of polyphenolic compounds. According to the results of our study, the herbal infusion of lemon balm provides 7.09 % of total phenols, which is a little more than compared to the results of Carnat et al. (1998), who found 11.8 % of total polyphenols in a lemon balm extract. However these results are influenced by the plant cultivar, extraction conditions or other factors preceding the determination. Although the infusions of black locust and chamomile are very often consumed due to numerous traditional medicinal uses and mild features, the results of this study indicate their low content of polyphenolic compounds. This might be explained by the fact that flowers instead of leaves or herb stems are used.

The content of total flavonoids and nonflavonoids follows the ranking of herbal infusions based on their TPC. Accordingly, the infusion with the highest TPC (lemon balm), contains as well the highest total flavonoid content (347.22 mg GAE/L) and total nonflavonoid content (347.22 mg GAE/L). Additionally, the

contents of total flavonoids and nonflavonoids are approximately equal in the investigated plants indicating to a uniform distribution of both flavonoid and nonflavonoid polyphenols in the investigated plants. This is not surprising taking into consideration the presence of a high content of both phenolic acids and flavonoid derivatives (mainly in the glycosilated form) in these plant species. The plants of the Lamiaceae family are characterized with a high content of rosmarinic acid, and other hydroxycinnamic acids like caffeic acid and chlorogenic acid, which display a broad spectrum of biological activities *in vitro* (Fecka and Turek, 2007). Beside these, numerous flavon- and flavonol-glycosides constitute the polyphenolic profile of medicinal herbs.

In order to provide a detailed insight in the compounds that constitute the flavonoid and non-flavonoid polyphenols of herbal infusions the content of flavan-3-ols and tannins was determined. Nettle infusion contained the highest flavan-3-ol content (8.43 mg catechin/L), followed by the infusions of thyme (8.34 mg catechin/L) and blackberry leaves (5.33 mg catechin/L), while olive leaves infusion contained the lowest flavan-3-ol content (0.48 mg catechin/L). The highest content of tannins was determined in blackberry leaves infusion (2.88 %), which is significantly lower than according to the results of Gudej and Tomczyk (2004), who found 4.12 -6.50 % of tannins in the leaves of several blackberry cultivars. These results justify the bitter and adstringent taste of this infusion. Lemon balm (2.59 %) and mint (2.25 %) were also characterized with a higher tannin content, which is in agreement with the results of previous studies (Carnat et al., 1998). As previously, the infusions containing the lowest total phenols also exhibited the lowest flavan-3-ol and tannin content (black locust, chamomile, olive leaves).

Table 2. The content of flavan-3-ols [mg(+)-catechin/L \pm SD] and tannins [% \pm SD] of herbal infusions

	Flavan-3-ols	Tannins
	mg (+)-catechin/L	%
<i>Lemon balm</i>	4.56 \pm 0.34	2.59 \pm 0.31
<i>Mint</i>	3.59 \pm 0.17	2.25 \pm 0.07
<i>Blackberry leaves</i>	5.33 \pm 0.61	2.88 \pm 0.16
<i>Thyme</i>	8.34 \pm 0.17	0.52 \pm 0.01
<i>Yarrow</i>	1.94 \pm 0.17	2.00 \pm 0.07
<i>Horsetail</i>	1.74 \pm 0.29	0.35 \pm 0.02
<i>Nettle</i>	8.43 \pm 0.29	0.89 \pm 0.09
<i>Black locust</i>	1.67 \pm 0.29	n.d.
<i>Chamomille</i>	4.65 \pm 0.29	0.17 \pm 0.01
<i>Olive leaves</i>	0.48 \pm 0.17	n.d.

The results confirm the common preferences of consumers, since the herbal infusions containing lower flavan-3-ols and tannins like chamomile and black locust provide milder, non-adstringent taste, while the ones imparting bitterness and adstringency (nettle, blackberry leaves) are not enjoyed so often among the consumers. Despite the taste, the consumption of herbal infusions should be more popularized among the consumers of all ages, because it assures the necessary daily intake of a variety of biologically active polyphenolic antioxidants.

Fig. 2. displays the antioxidant properties of herbal infusion determined by two different assays. The results of both assays indicate that the samples containing the highest TPC accordingly exhibit the highest antioxidant capacity. These observations were confirmed by a high correlation coefficient obtained between the TPC and antioxidant capacities ($r_{ABTS}=0.946$ and $r_{FRAP}=0.975$). As can be seen, the herbal infusions have separated in three groups according to their antioxidant properties. The herbs of the Lamiaceae family and blackberry leaves form the first one, which exhibit the best antioxidant properties, followed by yarrow, horsetail and nettle, forming the second group, while black locust, chamomile and olive leaf infusions constitute the last group with the poorest antioxidant potential. Compared to the previously determined contents of polyphenolic compounds, it is evident that the grouping of the herbal infusions based on the content of a specific compound is consistent throughout all determined polyphenolic compounds. This indicates the significant potential of consuming the herbal infusions of the Lamiaceae family and blackberry leaves, which significantly contribute to the daily intake of dietary polyphenols.

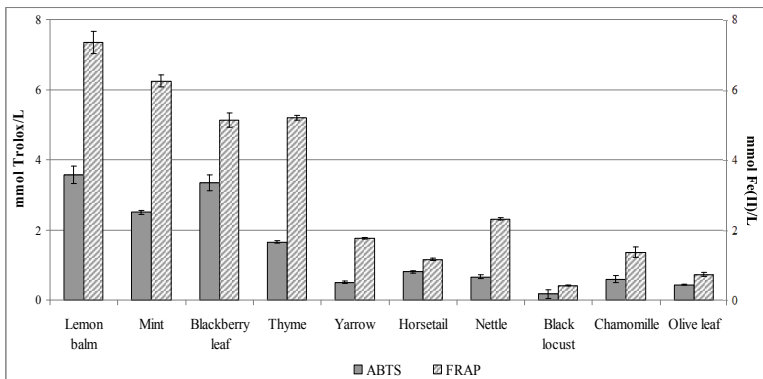

Fig. 2. Antioxidant capacity of herbal infusions determined by the ABTS (mM Trolox) and FRAP (mM Fe(II)) assays

Conclusions

Among the analyzed herbal infusions, the infusion of lemon balm was characterized as the richest source of polyphenolic compounds, as well as the highest antioxidant capacity. The content of total flavonoids and nonflavonoids follows the ranking of herbal infusions based on their TPC. Nettle infusion exhibited the highest flavan-3-ol content, while the infusion of blackberry leaves contained the highest tannin content. The infusions of olive leaf, black locust and chamomile were characterized as the poorest sources of all polyphenolic compounds. The obtained results suggest that due to the significant content of beneficial polyphenolic antioxidants, the consumption of herbal infusions should become more represented in the modern lifestyle in order to achieve the necessary daily intake of antioxidants.

References

- Benzie, I.F.F., Strain, J.J. (1996): The ferric reducing ability of plasma (FRAP) as a measure of “antioxidant power”: the FRAP assay, *Anal. Biochem.* 239, 70–76.
- Broer, J., Behnke, B. (2002): Immunosuppressant effect of IDS30, a stinging nettle leaf extract, on myeloid dendritic cells in vitro, *J. Rheumatology*, 4, 656–658.
- Bruneton, J. (1999): Pharmacognosy, phytochemistry, medicinal plants, Technique and Documentation, Paris: Lavoisier.
- Carnat, A.P., Carnat, A., Fraisse, D., Lamaison, J.L. (1998): The aromatic and polyphenolic composition of lemon balm (*Melissa officinalis* L. subsp. *officinalis*) tea, *Pharm. Acta Helv.* 72, 301–305.
- Di Stefano, R., Cravero, M.C., Gentilini, N. (1989): Metodi per lo studio dei polifenoli dei vini. *L'Enotecnico*, 25, 83-89.
- Fecka, I., Turek, S. (2007): Determination of water-soluble polyphenolic compounds in commercial herbal teas from Lamiaceae: peppermint, melissa, and sage, *J. Agric. Food Chem.* 55(26), 10908-17.
- Feng, R., Bowman, L.L., Lu, Y., Leonard, S.S., Shi, X., Jiang, B.H., Castranova, V., Vallyathan, V., Ding, M. (2004): Blackberry extracts inhibit activating protein 1 activation and cell transformation by perturbing the mitogenic signaling pathway, *Nutr. Canc.* 50, 80–89.
- Gallaher, R.N., Gallaher, K., Marshall, A.J., Marshall, A.C. (2006): Mineral analysis of ten types of commercially available tea, *J. Food. Comp. Anal.* 19, S53–S57.
- Gudej, J., Tomczyk, M. (2004): Determination of Flavonoids, Tannins and Ellagic Acid in Leaves from *Rubus* L. Species, *Arch. Pharm. Res.* 27(11), 1114-1119.
- Katalinić, V., Miloš, M., Kulišić, T., Jukić, M. (2006): Screening of medicinal plant extracts for antioxidant capacity and total phenols, *Food Chem.* 94, 550–557.
- Kramling, T.E., Singleton, V.E. (1969): An Estimate of the Nonflavonoid Phenols in Wines, *Am. J. Enol. Vitic.* 20, 86-92.
- Lachman, J., Hosnedl, V., Pivec, V., Orsák, M. (1998): Polyphenols in Cereals and Their Positive and Negative Role in Human and Animal Nutrition. In: Proceedings of Conference Cereals for Human Health and Preventive Nutrition, Brno, Czech Republic, pp. 118-125.

Topic: Food technology and biotechnology

- Mellgren, J. (2001): Healthy teas, *The Gourmet Retailer*, 22 (11), 58–63.
- Re, R., Pellegrini, N., Proteggente, A., Pannala, A., Yang, M., Rice-Evans, C. (1999): Antioxidant activity applying an improved ABTS radical cation decolorization assay, *Free Radic. Biol. Med.* 26, 1231–1237.
- Rodushkin, I., Ruth, T., Huhtasaari, A. (1999): Comparison of two digestion methods for elemental determinations in plant material by ICP techniques, *Anal. Chim. Acta*, 378, 191–200.
- Schneider, G. (1976): Zur Bestimmung der Gerbstoffe mit Casein, *Arch. Pharm.* 309, 38–44.
- Seeram, N.P., Adams, L.S., Zhang, Y., Lee, R., Sand, D., Scheuller, H.S., Heber, D. (2006): Blackberry, black raspberry, blueberry, cranberry, red raspberry, and strawberry extracts inhibit growth and stimulate apoptosis of human cancer cells in vitro, *J. Agric. Food Chem.* 54, 9329–9339.
- Serraino, I., Dugo, L., Dugo, P., Mondello, L., Mazzon, E., Dugo, G., Caputi, A.P., Cuzzocrea, S. (2003): Protective effects of cyanidin-3-O-glucoside from blackberry extract against peroxynitrite-induced endothelial dysfunction and vascular failure, *Life Sci.* 73, 1097–1114.
- Teucher, T., Obertreis, B., Ruttkowski, T., Schmitz, H. (1996): Cytokine secretion in whole blood for healthy subject following oral administration of *Urtica dioica* L. plant extract, *Arzneimittelforschung*, 9, 906–910.
- Van Wyk, B.E., Wink, M. (2004): Medicinal plants of the world, Portland, Oregon, USA: Timber Press, Inc.

Komparativna studija oksidacijske stabilnosti jestivih ulja sa Schaal oven testom i Rancimat metodom

UDC: 665.7.035.5

T. Moslavac^{1*}, A. Pozderović¹, A. Pichler¹, K. Volmut²

¹Sveučilište Josipa Jurja Strossmayera u Osijeku, Prehrambeno-tehnološki fakultet
Osijek, Franje Kuhača 20, 31000 Osijek, Hrvatska,

²IPK TVORNICA ULJA ČEPIN d.o.o., Grada Vukovara 18, 31431 Čepin, Hrvatska

Sažetak

Oksidacijska stabilnost je važan parametar kada se procjenjuje kvaliteta ulja i masti, daje dobru ocjenu njihove osjetljivosti na oksidacijsko kvarenje. Oksidacijska stabilnost različitih biljnih ulja istraživana je primjenom Schaal oven testa (63 °C) baziranom na određivanju peroksidnog broja i Rancimat metode baziranoj na konduktometrijskom mjerenju. Ispitivanja su provedena sa različitim biljnim uljima: suncokretovo ulje, laneno ulje, ulje kukuruzne klice, ulje kikirikija i rižino ulje. Oksidacija ulja inducirana je i mjerena primjenom Rancimat uređaja (model 743 Methrom). Rezultat oksidacije ulja izražen je sa indukcijom periodom (IP). Stabilnost ulja proporcionalna je indukcijom periodu. Peroksidne vrijednosti izražene su kao mmolO₂/kg. Rezultati mjerenja dobiveni Rancimat metodom podudaraju se sa onim baziranim na klasičnoj titraciji Schaal oven testom. Primjenom ovih metoda za praćenje stabilnosti biljnih ulja vidljivo je da rižino ulje ima najbolju stabilnost prema oksidaciji (Rancimat metoda), a ulje kukuruzne klice ima bolju stabilnost mjerenu Schaal oven testom. Laneno ulje pokazuje primjenom obje metode veliku osjetljivost na oksidacijsko kvarenje.

Ključne riječi: biljna ulja, oksidacijska stabilnost, Schaal oven test, Rancimat metoda

Uvod

Oksidacijsko kvarenje je najčešći tip kvarenja jestivih biljnih ulja, a predstavlja proces oksidacije nezasićenog lanca masne kiseline. Autooksidacija ulja može nastupiti sporije ili brže što ovisi o sastavu biljnog ulja, uvjetima skladištenja, prisutnosti sastojaka koji ubrzavaju ili usporavaju (antioksidansi) ovu reakciju oksidacije (Martin-Polvillo, 2004). Neugodan miris kao rezultat oksidacijskog kvarenja biljnih ulja pripisuje se primarnim i sekundarnim produktima oksidacije (Rovellini, 1997). Nastali produkti procesa autooksidacije u malim količinama narušavaju senzorska svojstva biljnih ulja (Broadbent i Pike, 2003). Održivost ili oksidacijska stabilnost jestivih biljnih ulja predstavlja vrijeme kroz koje se mogu sačuvati od procesa autooksidacije. Poznavanje stabilnosti ulja je važno kako bi se moglo unaprijed utvrditi vrijeme za koje se biljno ulje može sačuvati od jače

* tihomir.moslavac@ptfos.hr

izražene oksidacije te za određivanje vremenskog roka upotrebe ulja. Rezultati istraživanja oksidacijskog kvarenja biljnih ulja naglašavaju da im održivost ovisi, prije svega, o vrsti ulja odnosno o sastavu masnih kiselina kao i o udjelu prirodnih antioksidansa u ulju. Matthaus (1996) ukazuje da udjel pojedinih sastojaka biljnih ulja utječe na održivost suncokretovog ulja, repičinog ulja i orahovog ulja. Danas se najčešće primjenjuju metode za određivanje oksidacijske stabilnosti biljnih ulja temeljene na ubrzanoj oksidaciji ulja, a to su Schaal oven test, Swift test i Rancimat test (Shahidi, 2005; Farhoosh, 2008). Brojni istraživači provode komparativne studije oksidacijske stabilnosti jestivih biljnih ulja primjenom različitih instrumentalnih metoda za određivanje primarnih i sekundarnih produkata oksidacije ulja (Arain, 2009; Rudnik, 2001; Tan, 2002). Cilj istraživanja ovog rada bio je provesti komparativnu studiju oksidacijske stabilnosti jestivih biljnih ulja primjenom Schaal oven testa (63 °C) baziranom na određivanju peroksidnog broja i Rancimat metode baziranoj na konduktometrijskom mjerenju.

Materijali i metode

Ispitivanje oksidacijske stabilnosti određeno je u različitim vrstama biljnih ulja: suncokretovo ulje, ulje kukuruznih klica, ulje kikirikija, rižino ulje (rafinirana ulja), laneno ulje (hladno prešano). Ispitivanje početnih kemijskih karakteristika (parametara kvalitete) različitih biljnih ulja provedeno je primjenom standardnih metoda.

Određivanje slobodnih masnih kiselina

Porast kiselosti biljnih ulja nastaje kao rezultat hidrolitičke razgradnje triacilglicerola djelovanjem lipolitičkih enzima (lipaza) u prisustvu vode, a izražena je kao udjel (%) slobodnih masnih kiselina. Nastale slobodne masne kiseline (SMK) u uljima određene su standardnom metodom (ISO 660: 1996) koja se temelji na principu titracije s otopinom natrij-hidroksida.

Određivanje peroksidnog broja (Pbr)

Peroksidni broj je pokazatelj stupnja oksidacijskog kvarenja biljnih ulja. Određivanje peroksidnog broja je jedna od najviše primjenjivanih metoda za ispitivanje primarnih produkata oksidacije biljnih ulja (hidroperoksidi, peroksidi). Peroksidni broj ispitivanih biljnih ulja određen je standardnom metodom (ISO 3960:1998). Rezultat je izražen kao mmol aktivnog kisika koji potječe iz nastalih peroksida prisutnih u 1 kg ulja (mmol O₂/kg).

Određivanje anisidinskog broja (Abr)

Anisidinski broj omogućava direktno određivanje količine nehlapljivih karbonilnih spojeva, a predstavljaju sekundarne produkte oksidacije biljnih ulja

koji su nastali razgradnjom nestabilnih primarnih produkata oksidacije. Nastali nehlapljivi karbonilni spojevi negativno utječu na oksidacijsku stabilnost biljnih ulja te narušavaju senzorska svojstva. Iz njihove vrijednosti može se procijeniti održivost jestivog ulja. Veća vrijednost ovog broja ukazuje na slabiju održivost ulja. Smatra se da biljno ulje dobre kvalitete treba imati vrijednost anisidinskog broja manju od 10 (nema ograničenja u zakonskom propisu). Anisidinski broj ispitivanih biljnih ulja određen je standardnom metodom (ISO 6885), a temelji se na reakciji p- anisidina sa višim nezasićenim aldehydima (2,4-dienal i 2-enal) u kiselom mediju (octenoj kiselini), pri čemu nastaju Schiff-ove baze.

Određivanje Totox broja (TB)

Vrijednost peroksidnog broja u kombinaciji sa anisidinskim brojem koristi se za određivanje ukupne oksidacijske vrijednosti (OV) biljnih ulja ili Totox broja. Rezultat Totox broja izračunava se prema jednadžbi:

$$\text{Totox broj} = 2 \text{ Pbr} + \text{Abr}$$

Totox broj ili oksidacijska vrijednost ulja smatra se vrlo korisnim pokazateljem kvalitete i oksidacijske stabilnosti biljnih ulja jer se preko anisidinskog broja dobije podatak o oksidacijskoj prošlosti ulja, a preko peroksidnog broja o trenutnom oksidacijskom stanju ulja.

Određivanje oksidacijske stabilnosti ulja

Poznavanje oksidacijske stabilnosti biljnih ulja važno je kako bi se unaprijed moglo odrediti vrijeme za koje se ulje može sačuvati od jače izražene oksidacije, bez bitnih promjena kvalitete.

Rancimat metoda

Održivost ili oksidacijska stabilnost ispitivanih biljnih ulja određena je testom ubrzane oksidacije ulja Rancimat testom (ISO 6886:2006E). Test se temelji na ubrzanom kvarenju biljnih ulja pri povišenim temperaturama uz konstantan dovod zraka određene brzine protoka u uzorak ulja. Indukcijski period (IP) oksidacije ulja određuje se na osnovi količine izdvojenih kratko lančanih hlapljivih organskih kiselina, uvedenih u demineraliziranu vodu. Mjerenjem porasta vodljivosti vode indirektno se prati tijek oksidacijskog kvarenja ulja. Vrijednost indukcijskog perioda (vrijeme izraženo u satima) ukazuje na otpornost ispitivanog biljnog ulja prema oksidaciji. Dobivena veća vrijednost indukcijskog perioda predstavlja i veću oksidacijsku stabilnost ili održivost ulja. Korišten je automatski uređaj za određivanje oksidacijske stabilnosti ulja Rancimat model 743 (Metrohm, Švicarska), kod uvjeta rada: masa uzorka ulja

3,0 g, temperatura 120 °C, protok zraka 9 L/h. Određivanje oksidacijske stabilnosti svih uzoraka ulja provedeno je u duplikatu, a prikazana je srednja vrijednost indukcijskog perioda.

Schaal oven test

Schaal oven test je jedna od najstarijih metoda za određivanje oksidacijske stabilnosti jestivih biljnih ulja. Primjenom ovog testa uzorci biljnih ulja se zagrijevaju u termostatu pri temperaturi 63 °C te se prati porast vrijednosti peroksidnog broja ili promjene senzorskih svojstava ulja nastale oksidacijskim kvarenjem u određenim vremenskim razmacima (satima, danima, tjednima). Rezultat za oksidacijsku stabilnost ispitivanih biljnih ulja primjenom ovog testa prikazan je kao vrijednost peroksidnog broja nakon određenog vremena provedbe testa (4 dana). Ovaj način ispitivanja je naročito pogodan ako se provodi međusobno uspoređivanje različitih biljnih ulja po oksidacijskoj stabilnosti ili održivosti. Dobiveni rezultati ovim testom pri 63 °C daju nam najpribližnji podatak za procjenu stvarne održivosti biljnih ulja. Ustanovljeno je da vrijednost jednog dana održivosti ulja sa Schaal oven testom odgovara stvarnoj održivosti ulja od 6 do 12 dana pri sobnoj temperaturi (oko 20 °C).

Rezultati i rasprava

U Tablici 1 iznesene su kemijske karakteristike različitih vrsta biljnih ulja korištenih za ispitivanje oksidacijske stabilnosti primjenom Rancimat metode i Schaal oven testa. Vrijednosti dobivene za slobodne masne kiseline (SMK) i peroksidni broj (Pbr) su u skladu sa *Pravilnikom o jestivim uljima i mastima* (Narodne novine 22/10), a rezultati za anisidinski broj (Abr) i Totox broj (TB) ukazuju na to da su ispitivane vrste biljnih ulja dobre kvalitete.

Tablica 1. Početne kemijske karakteristike ispitivanih biljnih ulja
Table 1. Initial chemical characteristics of the analyzed vegetable oils

	SMK (%)	Pbr (mmolO ₂ /kg)	Abr	TB
Suncokretovo ulje	0,06 ± 0,01	0,21 ± 0,09	7,15 ± 0,11	7,57
Laneno ulje	1,15 ± 0,02	1,05 ± 0,03	0,89 ± 0,01	2,99
Ulje kikirikija	0,04 ± 0,03	1,79 ± 0,01	5,01 ± 0,09	8,59
Ulje kukuruznih klica	0,12 ± 0,01	0,73 ± 0,02	7,63 ± 0,03	9,09
Rižino ulje	0,24 ± 0,01	1,88 ± 0,01	5,67 ± 0,01	9,43

SMK - slobodne masne kiseline (% oleinske kiseline)

SMK - free fatty acid (%)

Pbr - peroksidni broj (mmolO₂/kg)

Pbr - peroxide value

Abr - anisidinski broj

Abr - anisidine value

TB - Totox broj

±SD (n=2)

Oksidacijska stabilnost ispitivanih biljnih ulja određena Rancimat metodom, izražena indukcijskim periodom (IP) u satima prikazana je u Tablici 2.

Tablica 2. Oksidacijska stabilnost biljnih ulja određena Rancimat metodom
Table 2. Oxidative stability of vegetable oils determined by the Rancimat method

	IP (h)
Suncokretovo ulje	2,68 ± 0,03
Laneno ulje	0,13 ± 0,08
Ulje kikirikija	4,45 ± 0,09
Ulje kukuruznih klica	4,95 ± 0,02
Rižino ulje	5,49 ± 0,04

IP - indukcijski period (h)

IP - induction period (h)

±SD (n=2)

Vrijednosti (IP) dobivene Rancimat testom pokazuju da rižino ulje, ulje kukuruznih klica i ulje kikirikija imaju dobru stabilnost i otpornost prema oksidacijskom kvarenju. Kod ispitivanih biljnih ulja rižino ulje pokazuje najbolju oksidacijsku stabilnost kod navedenih uvjeta testa. Razlog tome je visok udjel oleinske kiseline 18:1 (42,5 %) dok je udjel linolne kiseline 18:2 iznosio 39 % od ukupnih masnih kiselina. Također, visok udjel α -tokoferola (vitamin E) i antioksidansa te aktivni sastojak γ -oryzanol (1 %) kod rižinog ulja utječu na održivost ulja, osiguravaju dobru stabilnost ulja na oksidacijsko kvarenje pri čemu je dobiven indukcijski period (IP) 5,49 h. Indukcijski period ulja kukuruznih klica (4,95 h) ukazuje također na bolju stabilnost u odnosu na suncokretovo ulje (2,68 h). Dobru oksidacijsku stabilnost ulja kukuruznih klica osigurava visok udjel prirodnih antioksidansa (ukupnih tokoferola i fenolne kiseline), naročito visok udjel γ -tokoferola (70-80 % od ukupnih) koji je antioksidans veće aktivnosti. Dobra održivost ovog ulja ostvarena je i zbog prisustva ubikvinona (koenzim Q) oko 200 mg/kg koji ima antioksidacijski učinak (Dimić, 2005). Merrill i sur. (2008) izvješćuju o oksidacijskoj stabilnosti konvencionalnih i visoko-oleinskih biljnih ulja koja su ispitivana OSI testom, vidljivo je da ulje kukuruznih klica pokazuje odličnu održivost. Indukcijski period ulja kikirikija pokazuje dobru stabilnost zahvaljujući većem udjelu oleinske kiseline u sastavu masnih kiselina te udjelu prirodnog antioksidansa γ -tokoferola. Rezultati održivosti biljnih ulja su u suglasnosti s istraživanjima Farhoosha i sur. (2008) koji su istraživali utjecaj parametara provedbe Rancimat testa na oksidacijsku stabilnost biljnih ulja. Chu i Hsu (1999) su ispitivali utjecaj prirodnih antioksidansa na oksidacijsku stabilnost ulja kikirikija primjenom OSI testa i dobili dobre rezultate održivosti ulja. Od svih istraživanih biljnih ulja izuzetak je laneno ulje koje ima vrlo malu oksidacijsku stabilnost sa dobivenim niskim indukcijskim periodom 0,13 h. Velika osjetljivost na oksidaciju i slabija

održivost lanenog ulja uzrokovana je visokim udjelom nezasićenih masnih kiselina (linolna, linolenska- preko 50 %). Stoga ovo ulje nije pogodno za pripremu hrane prženjem (Haumann, 1990).

Oksidacijska stabilnost ispitivanih biljnih ulja određena je Schaal oven testom (63 °C). Tijekom 4 dana praćena je vrijednost peroksidnog broja svakih 12 sati te su rezultati prikazani u Tablici 3. Svi uzorci biljnih ulja pokazali su postepeni porast peroksidnog broja (Pbr) sa vremenom provedbe testa. Povećanje Pbr puno je veće za laneno ulje. Rezultati u tablici pokazuju da ovo ulje ima najmanju oksidacijsku stabilnost, jer su dobivene veće vrijednosti peroksidnog broja nakon 4 dana testa pri 63 °C u odnosu na druga ulja. Zapaženo je da ulje kukuruznih klica i rižino ulje imaju bolju oksidacijsku stabilnost kod ovih uvjeta Schaal oven testa, postignuta je niska vrijednost Pbr 2,14 i 4,78 (mmolO₂/kg ulja) nakon 4 dana testa.

Tablica 3. Oksidacijska stabilnost biljnih ulja određena Schaal oven testom tijekom 4 dana praćena peroksidnim brojem svakih 12 sati

Table 3. Oxidative stability of vegetable oils determined by the Schaal oven test during 4 days followed by measurement of peroxide values each 12 hours

Biljno ulje	Pbr (mmol O ₂ /kg)								
	početni	12	24	36	48	60	72	84	96 (sati)
Suncokretovo ulje	0,21	0,49	1,11	1,75	3,17	5,22	6,51	8,28	10,61
Laneno ulje	1,05	2,20	4,20	6,04	8,47	10,20	12,38	14,55	15,51
Ulje kikirikija	1,79	2,01	2,55	3,15	3,43	4,48	4,66	6,06	7,22
Ulje kukuruznih klica	0,73	0,90	1,00	1,56	1,60	1,68	1,74	1,81	2,14
Rižino ulje	1,88	1,98	1,97	2,06	2,23	3,16	3,28	4,04	4,78

Pbr - peroksidni broj, mmol O₂/kg

Usporedbom dobivenih rezultata određivanja oksidacijske stabilnosti ispitivanih biljnih ulja primjenom Rancimat metode i Schaal oven testa prikazanih u Tablicama 2 i 3 može se uočiti da postoji određena sličnost dobivenih vrijednosti za stabilnost ovih ulja. Primjenom ovih metoda za praćenje stabilnosti ispitivanih ulja vidljivo je da rižino ulje i ulje kukuruznih klica imaju bolju stabilnost prema oksidaciji, a laneno ulje ostvaruje najmanju stabilnost.

Zaključak

Usporedbom dobivenih rezultata određivanja oksidacijske stabilnosti ispitivanih biljnih ulja primjenom Rancimat metode i Schaal oven testa može se uočiti da postoji određena sličnost dobivenih vrijednosti za održivost ovih ulja.

Primjenom ovih metoda vidljivo je da rižino ulje ima najbolju stabilnost prema oksidaciji (Rancimat metoda), a ulje kukuruzne klice ima bolju stabilnost mjerenu Schaal oven testom.

Laneno ulje pokazuje primjenom obje metode veliku osjetljivost na oksidacijsko kvarenje, ostvaruje najmanju stabilnost ili održivost zbog visokog udjela nezasićenih masnih kiselina.

Ulje kikirikija pokazuje bolju održivost zbog većeg udjela oleinske kiseline u odnosu na suncokretovo ulje gdje dominira linolna kiselina.

Literatura

- Arain, S., Sherazi, S.T.H., Bhangar, M.I., Talpur, F.N., Mahesar, S.A. (2009): Oxidative stability assessment of Bauhinia purpurea seed oil in comparison to two conventional vegetable oils by differential scanning calorimetry and Rancimat methods, *Thermochimica Acta* 484, 1-3.
- Broadbent, C.J., Pike, O.A. (2003): Oil stability indeks correlated with sensory determination of oxidative stability in canola oil, *JAACS* 80, 59-63.
- Chu, Y. H., Hsu, H. F. (1999): Effects of antioxidants on peanut oil stability, *Food Chemistry* 66 (1), 29-34.
- Dimić, E. (2005): Hladno ceđena ulja, Tehnološki fakultet Novi Sad, pp. 83-87.
- Farhoosh, R., Niazmand, R., Rezaei, M., Sarabi, M. (2008): Kinetic parameter determination of vegetable oil oxidation under Rancimat test conditions, *Eur J Lipid Sci Tech* 110 (6), 587-592.
- HRN EN ISO 660, Životinjske i biljne masti i ulja, Određivanje kiselinskog broja i kiselosti, 1996.
- HRN EN ISO 3960, Životinjske i biljne masti i ulja, Određivanje peroksidnog broja - Jodometrijsko određivanje točke završetka, 2007.
- HRN EN ISO 6885, Životinjske i biljne masti i ulja, Određivanje anisidinskog broja, 2006.
- ISO 6886:2006(E), Životinjske i biljne masti i ulja, Određivanje oksidacijske stabilnosti (test ubrzane oksidacije), 2006.
- Haumann, B. F. (1990): Low-Linolenic flax:ariatio on familia oliseed, *INFORM* 1 (11), 934-941.
- Martin-Polvillo, M., Marquez-Ruiz, G., Dobarganes, M.C. (2004): Oxidative stability of sunflower oils differing in unsaturation degree during long-term storage at room temperature, *JAACS* 81, 577-583.
- Matthaus, B.W. (1996): Determination of the Oxidative Stability of Vegetable Oils by Rancimat and Conductivity and Chemiluminescence Measurements, *JAACS* 73 (8), 1039-1043.

- Rudnik, E., Szczucinska, A., Gwardiak, H., Szulc, A., Winiarska, A. (2001): Comparative studies of oxidative stability of linseed oil, *Thermochimica Acta* 370, 135-140.
- Merrill, L. I., Pike, O. A., Ogden, L. V. (2008): Oxidative Stability of Conventional and High-Oleic Vegetable Oils with Added Antioxidants, *JOACS* 85, 771-776.
- Rovellini, P., Cortesi, N., Fedeli, E. (1997): Ossidazioni dei lipidi. Nota 1. *Rivista Italiana delle Sostanze Grasse* 74, 181-189.
- Shahidi, F. (2005): Bailey's Industrial Oil and Fat Products (Sixth edition), Volume 1, Edible Oil and Fat Products: Chemistry, Properties and Health Effects, Eiley-Interscience publication, 269-513.
- Tan, C. P., Che Man, Y. B., Selamat, J., Yusoff, M. S. A. (2002): Comparative studies of oxidative stability of edible oils by differential scanning calorimetry and oxidative stability indeks methods, *Food Chemistry* 76, 385-389.

Comparative studies of oxidative stability of edible oils by Schaal oven test and the Rancimat method

T. Moslavac¹, A. Pozderović¹, A. Pichler¹, K. Volmut²

¹University of Josip Juraj Strossmayer in Osijek, Faculty of Food Technology Osijek, Franje Kuhača 20, 31000 Osijek, Croatia

²IPK TVORNICA ULJA ČEPIN d.o.o., Grada Vukovara 18, 31431 Čepin, Croatia

Summary

Oxidative stability is an important parameter when evaluating the quality of oils and fats, as it gives a good estimation of their susceptibility to oxidative deterioration. The oxidative stability of different vegetable oils was studied using the Schaal Oven test (63 °C) method based on determination of peroxide value and Rancimat method based on conductometric measurements. Different vegetable oil samples were used in this study: sunflower oil, linseed oil, corn oil, peanut oil and rice bran oil. The oxidation was induced and measured using Rancimat equipment (model 743 Methrom). The result of oil oxidation was expressed as induction period (IP). Stability is proportional to the induction period. Peroxide values were expressed as mmolO₂/kg. The results obtained from Rancimat method measurements correspond with those based on the classical titration method Schaal Oven test. By applying these methods for tracking vegetable oils stability, it is observed that the rice bran oil has the highest stability against oxidation (the Rancimat method), and the corn oil has the highest stability measurable by the Schaal Oven test. Linseed oil shows a great susceptibility to oxidative deterioration, when both methods applied.

Keywords: vegetable oils, oxidative stability, Schaal Oven test, Rancimat method

Proizvodnja i primjena bakterijskih egzopolisaharida u pekarstvu

UDC: 664.66.022.39

J. Mrvčić*, O. Hrsto, D. Stanzer, S. Grba, V. Stehlik-Tomas

Prehrambeno-biotehnološki fakultet, Laboratorij za tehnologiju vrenja i kvasca, Pierotijeva 6, 10000 Zagreb, Hrvatska

Sažetak

Pojedine bakterije mliječne kiseline proizvode egzopolisaharide tijekom primijene u proizvodnji pekarskih proizvoda. Egzopolisaharidi mogu zamijeniti hidrokoloide koji se koriste za poboljšanje volumena, teksture, svježine i roka trajanja pekarskih proizvoda. U ovom istraživanju optimiran je proces proizvodnje egzopolisaharida u MRS podlozi i *in situ* s pomoću bakterije *Leuconostoc mesenteroides*. Analiza sintetiziranih egzopolisaharida pokazala je da se radi o homopolisaharidu dekstranu. Rezultati su također pokazali da je sinteza egzopolisaharida i u MRS podlozi i u tijestu vezana za rast, a optimalni parametri procesa njihove sinteze su: temperatura 20 °C, vrijeme procesa 18 h, te koncentracija saharoze 110 g/L. Pri istim uvjetima sintetizirano je oko 15 g/L egzopolisaharida u MRS podlozi te oko 19 g egzopolisaharida/kg brašna tijekom kiseljenja tijesta. Dodatak saharoze u tijesto u cilju sinteze egzopolisaharida tijekom kiseljenja tijesta, nije imao utjecaj na proizvodnju kiselina, tj. na sam proces kiseljenja tijesta.

Ključne riječi: egzopolisaharidi, bakterije mliječne kiseline, pekarstvo

Uvod

Hucker i Pederson su još 1930. g. prvi objavili da vrste roda *Leuconostoc* proizvode dekstran. Dekstran je polisaharid visoke molekulske mase, sastavljen od jedinica D-glukoze, kojeg iz saharoze osim vrsta iz roda *Leuconostoc* proizvode i brojne druge vrste bakterija, prije svega iz rodova *Streptococcus* te *Acetobacter*. Iako se dekstran, obzirom na veliku primjenu u prehrambenoj, kemijskoj i farmaceutskoj industriji komercijalno proizvodi, trenutno se provode brojna znanstvena istraživanja o proizvodnji dekstrana te drugih egzopolisaharida (EPS) s pomoću mikroorganizama. Prvenstveno se istražuje mogućnost primjene novih mikroorganizama kao proizvođača EPS (Sarwat i sur., 2008; Bounaix i sur., 2009) te potencijalna prebiotička aktivnost EPS (Semjonovs i sur., 2008). Provode se i istraživanja o utjecaju EPS na reološka svojstva prehrambenih proizvoda (Katina, 2005; Ketabi i sur., 2008).

Velika raznovrsnost mikrobnih EPS otvara im mogućnost primjene u brojnim prehrambenim proizvodima, pa tako i u pekarstvu. Naime, u pekarstvu se

*jmrvcic@pbf.hr

trenutno koriste znatne količine aditiva koji sadrže hidrokoloide. Korišteni hidrokoloidi najčešće su biljnog podrijetla i odlikuju se sposobnošću vezanja veće količine vode u tijestu, što pozitivno djeluje na volumen, teksturu, svježinu i rok trajanja kruha. Mikrobni EPS sintetizirani u tijestu djeluju isto kao i hidrokoloidi. Preliminarni rezultati o ulozi reuterana, dekstrana i levana proizvedenih s pomoću bakterija mliječne kiseline (BMK) u pekarstvu pokazuju da EPS efektivno poboljšavaju reološka svojstva tijesta i kvalitetu kruha (Korakli i sur., 2006; Brandt i sur., 2003; Tiekling i sur., 2003). Posebice se istražuje bakterija *Leuc. mesenteroides* koja se odlikuje visokom produktivnošću EPS dekstrana (Decock i Capelle, 2005). Prednosti određenih tipova dekstrana i tijesta sa dodatkom dekstrana su višestruke. Zbog svoje hidrokoloidne prirode dekstran veže više vode u tijesto, što ima za posljedicu povećanu svježinu gotovog proizvoda. Dekstran poboljšava i stabilnost tijesta i sposobnost tijesta da zadrži CO₂ tako što sudjeluje u stvaranju glutenske mreže čime se poboljšava učinak dizanja tijesta (Tiekling i sur., 2003). Stoga se nameće zaključak da bi EPS sintetizirani s pomoću BMK koje se koriste u kiseljenju tijesta mogli zamijeniti ili smanjiti uporabu sve skupljih aditiva u pekarskoj industriji. Dodatak aditiva u pekarske proizvode podliježe deklariranju, pa zamjena hidrokoloida egzopolisaharidima sintetiziranim tijekom fermentacije zadovoljava sve veće zahtjeve potrošača za proizvodnjom hrane "prirodnim putem". Pored toga sintetizirani egzopolisaharidi mogu djelovati i kao prebiotici te antioksidansi (Kodali i Sen, 2008).

Biosinteza i sekrecija EPS s pomoću BMK odvija se tijekom različitih faza rasta, a tip i količina sintetiziranih EPS ovisi o samom mikroorganizmu te uvjetima rasta. Količina EPS sintetiziranih s pomoću BMK ovisi o sastavu podloge (ugljkovim i dušikovim spojevima) te uvjetima fermentacije: temperaturi, vremenu fermentacije i pH vrijednosti (Degeest i de Vuyst, 2000). Osnovni problem proizvodnje EPS s pomoću BMK su vrlo niski prinosi koji se kreću oko 0.1-1.5 g/L, dok komercijalno primjenjena bakterija *X. campestris* proizvodi oko 30-50 g/L EPS. Smatra se da bi ekonomska isplativost proizvodnje i izolacije EPS sintetiziranih s pomoću BMK za primjenu kao prehrambenih aditiva trebala biti oko 10-15 g/L. Ukoliko se EPS proizvode *in situ* prinosi mogu biti znatno manji.

Cilj ovog rada bio je optimirati proces proizvodnje EPS u MRS podlozi i *in situ* s pomoću *Leuc. mesenteroides*, jedne od bakterija u starteru mješovitih kultura koji se koristi za proizvodnju kiselog tijesta u nekim hrvatskim pekarama.

Materijal i metode

Identifikacija proizvodnih sojeva

Kulture bakterija *Leuc. mesenteroides*, *L. brevis*, *L. plantarum*, *L. casei*, *P. acidilactici* i *P. pentosaceus* čuvane su na kosom modificiranom MRS agaru (glukoza je

zamijenjena istom količinom maltoze) u hladnjaku pri temperaturi +4 °C. S kosog MRS agara kulture su naciyepljene u epruvete sa po 10 mL sterilne tekuće MRS podloge. Nakon inkubacije tijekom 24 sata, razrijeđene kulture naciyepljene su na Petrijeve ploče s krutom MRS podlogom u koju je dodano 50 g/L saharoze. Petrijeve ploče inkubirane su u termostatu 48 h na 32 °C. Sluzavi rast bio je indikator vrste koja proizvodi EPS.

Priprema inokuluma

S kosog MRS agara, kultura *Leuc. mesenteroides* naciyepljena je u epruvete sa po 10 mL sterilne tekuće MRS podloge. Nakon inkubacije tijekom 18 sati, umnožena kultura prebačena je u Erlenmeyerove tikvice od 500 mL, sa 200 mL sterilne podloge istog sastava. Tikvice začepljene vatenim čepovima trešene su na rotacijskoj tresilici pri 60 o/min i 32 °C tijekom 18 sati. Prirasla biomasa (5 % v/v) korištena je kao inokulum za proizvodnju egzopolisaharida u MRS podlozi, ili je odcentrifugirana i korištena kao inokulum za proces proizvodnje egzopolisaharida *in situ*.

Planiranje eksperimenta i proizvodnja egzopolisaharida

Kako bi se ispitao utjecaj temperature, vremena fermentacije i koncentracije saharoze na sintezu egzopolisaharida kako u MRS podlozi tako i *in situ*, korišten je program Design-Expert ("central composite design in response surface methodology"). Pokus je sadržavao 15 uzoraka i svaki je ponovljen tri puta. Tijekom proizvodnje egzopolisaharida u tekućem mediju, MRS podlozi je nakon inokulacije dodavana različita koncentracija saharoze (40, 50, 75, 100, 110 g/L) te su tikvice inkubirane na različitim temperaturama (6, 10, 20, 30, 34 °C) različito vrijeme (14, 15, 17.5, 20, 21 h). Proizvodnja egzopolisaharida *in situ* provodila se u staklenim čašama od 100 mL, s 50 g tijesta (iskorištenje tijesta: 200). Tijestu je također nakon inokulacije dodavana saharoza u navedenim količinama te je sinteza EPS provedena na gore navedenim temperaturama različito vrijeme.

Izolacija i pročišćavanje EPS

Metoda izolacije EPS temelji se na taloženju EPS s etanolom (Ruas-Madiedo i Reyes-Gavilan, 2005). Nakon provedene sinteze 10 ml uzorka stavljeno je na taloženje s 20 ml 10 % trikloroctene kiseline u hladnjak preko noći. Uzorak je zatim centrifugiran 10 min na 10000 o/min kako bi se uklonili istaloženi proteini. Supernatantu koji sadrži EPS dodana su 2 volumena etanola te je također provedeno taloženje preko noći u hladnjaku. Izolirani EPS su zatim sušeni na 105 °C do konstantne mase i vagani.

Za izolaciju EPS iz tijesta odvagano je oko 5 g tijesta te su mu dodana dva volumena vode. Uzorak je nakon homogenizacije centrifugiran 10 min na 10000 o/min. Nakon

toga provedeno je pročišćavanje supernatanta s trikloroocetnom kiselinom te taloženje EPS s etanolom kao što je predhodno opisano.

Identifikacija EPS izoliranih iz MRS podloge i tijesta

Izolirani EPS hidrolizirani su prema slijedećoj metodi: Oko 1g EPS dobivenih nakon taloženja etanolom hidrolizirano je s 5 ml 2M H₂SO₄, 1 sat, u autoklavu na 121 °C. Nakon toga suspenzija je neutralizirana s 2M NaOH. Sastav monosaharida, kao i koncentracija fermentabilnih šećera i mliječne kiseline, određen je s pomoću HPLC uređaja ProStar Varian 230, na RI detektoru, uz pomoć MetaCarb 67H, 300 × 6.5 mm kolone, te mobilne faze 5 mM H₂SO₄ (Mrvčić, 2008).

Rezultati i diskusija

Identifikacija proizvodnih sojeva i karakterizacija sintetiziranih EPS

Kako bi se ispitala mogućnost pojedinih vrsta BMK koje se koriste u kiseljenju tijesta da proizvode EPS, provedeni su preliminarni pokusi naciepljivanja pojedinih vrsta BMK na Petrijeve ploče s krutom MRS podlogom kojoj je dodana saharoza. Ispitane su vrste *Leuc. mesenteroides*, *L. brevis*, *L. plantarum* te *L. casei* iz zbirke mikroorganizama Laboratorija za tehnologiju vrenja i kvasca, te *P. acidilactici* i *P. pentosaceus* izolirani iz komercijalnih startera (LA-1, LA-2, Lalvain). Iako se u literaturi mogu naći podaci da *L. plantarum* te vrste roda *Pediococcus* proizvode EPS, sposobnost proizvodnje EPS pokazao je samo *Leuc. mesenteroides*. Na Slici 1 vidljiv je sluzavi rast ove bakterije na podlozi s dodatkom saharoze što upućuje na proizvodnju EPS (EPS⁺ fenotip). Poznato je da bakterija *L. brevis* ne proizvodi EPS i korištena je kao negativna kontrola. HPLC analiza kiselinskog hidrolizata EPS proizvedenih u MRS podlozi uz dodatak saharoze pokazala je da se radi o homopolisaharidu dekstranu, obzirom da je u hidrolizatu detektirana samo glukoza (Hrsto, 2010).

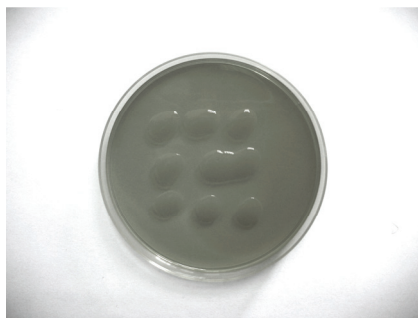

Slika 1. Sluzavi rast *Leuc. mesenteroides* na MRS agaru s dodatkom 5 % saharoze
Fig. 1. Slimy growth of *Leuc. mesenteroides* on MRS agar with addition of 5 % sucrose

Optimiranje procesa proizvodnje EPS u MRS podlozi

Iako su provedena brojna istraživanja, u literaturi su prisutni kontradiktorni podaci o utjecaju pojedinih parametara fermentacije, prije svega temperature i vremena fermentacije, na prinos egzopolisaharida (Degeest i sur., 2000). Stoga su provedena istraživanja utjecaja parametara procesa na sintezu EPS u cilju njihove optimizacije. Ispitan je utjecaj temperature, vremena fermentacije i koncentracije saharoze na prinos EPS (Slike 2 i 3).

Prema literaturnim podacima temperatura, koncentracija saharoze te vrijeme sinteze najvažniji su parametri koji utječu na sintezu EPS. Optimalna temperatura sinteze EPS često se razlikuje od temperature optimalne za rast. De Vuyst i Degeest (1999) navode da niska temperatura potiče proizvodnju EPS što se objašnjava činjenicom da pri temperaturi različitoj od optimalne stanice sporije rastu i sporije sintetiziraju polimere stanične stjenke, pri čemu je više molekula raspoloživo za biosintezu EPS. S druge strane neki literaturni navodi ukazuju na veću proizvodnju EPS pri višim temperaturama i temperaturama optimalnim za rast. Tallgren i sur. (1999) navode kao optimalnu temperaturu sinteze dekstrana s pomoću *Leuc. mesenteroides* 5-13 °C, dok su Sarwat i sur. (2008) postigli maksimum sinteze dekstrana s *Leuc. mesenteroides* CMG713 na 30 °C. Rezultati ostvareni u ovom istraživanju ukazuju na razliku temperaturnih optimuma rasta i sinteze EPS u slučaju ispitivanog soja *Leuc. mesenteroides*. Naime, optimalna temperatura rasta radnog mikroorganizma je 32 °C, dok je optimalna temperatura sinteze EPS oko 20 °C (Slike 2 i 3). Pri ovoj temperaturi dobiveno je 15,5 g/L EPS uz dodatak 110 g/L saharoze nakon 18 h fermentacije. Pri nižim (10 °C) i višim (30 °C) temperaturama ostvarene su manje količine sintetiziranih EPS. Smanjenje sinteze EPS pri ekstremnim temperaturama u literaturi je objašnjeno nestabilnošću enzima dekstran sukraze. Isto tako, temperatura ne utječe samo na količinu sintetiziranih EPS već i na molekularnu masu sintetiziranih EPS (Pereira-Duta i sur., 2005).

Vrijeme potrebno za sintezu maksimalne količine EPS ovisi o koncentraciji saharoze. Iako brojna istraživanja ukazuju na vrijeme potrebno za sintezu EPS od 72 - 96 h, u ovom istraživanju utvrđeno je da je za postizanje maksimalne količine EPS dovoljno oko 18 h. Produljenjem vremena inkubacije ne dolazi do daljnje sinteze EPS iako saharoza nije u potpunosti iscrpljena iz podloge (rezultati nisu prikazani). To se može objasniti negativnim utjecajem niske pH vrijednosti na sintezu EPS. Kinetika proizvodnje EPS s pomoću ove bakterije karakteristična je krivulja proizvodnje metabolita vezanog za rast. Sinteza EPS počinje gotovo istovremeno s rastom, pokazuje maksimalnu brzinu kada se kultura nalazi u eksponencijalnoj fazi rasta i postiže maksimum na kraju eksponencijalne faze rasta tj. na kraju aktivnog rasta (Hrsto, 2010). U literaturi se mogu naći podaci i o EPS kao sekundarnim metabolitima čija sinteza se odvija u stacionarnoj fazi rasta (Petry i sur., 2000).

Utjecaj koncentracije saharoze u MRS podlozi na sintezu EPS ispitivan je pri koncentraciji saharoze od 40 – 110 g/L. Rezultati su pokazali da koncentracija

saharaze znatno utječe na koncentraciju sintetiziranih EPS (Slika 3). Maksimalna koncentracija EPS postignuta je pri najvećoj koncentraciji saharoze u podlozi.

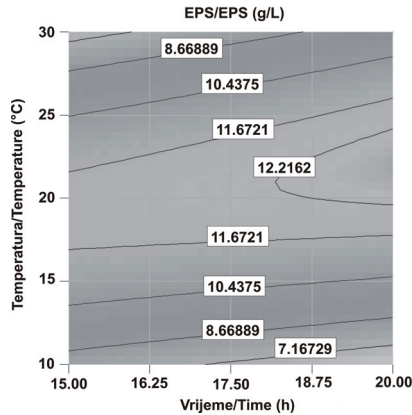

Slika 2. Utjecaj temperature i vremena fermentacije na koncentraciju sintetiziranih EPS pri koncentraciji saharoze od 75 g/L u MRS podlozi
Fig. 2. The effect of temperature and time of fermentation on the synthesized EPS concentration in MRS medium with addition of 75 g/L sucrose

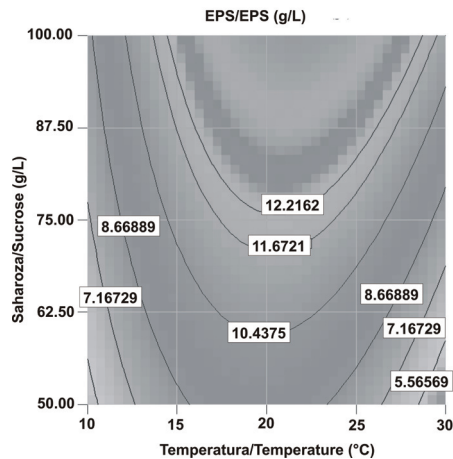

Slika 3. Utjecaj koncentracije saharoze dodane u MRS podlogu i temperature fermentacije na koncentraciju sintetiziranih EPS nakon 18 h fermentacije
Fig. 3. The influence of fermentation temperature and sucrose concentration in MRS medium on the EPS concentration after 18 hours of fermentation

Optimiranje procesa proizvodnje EPS in situ

Nekoliko vrsta BMK, većinom iz rodu *Leuconostoc* i *Lactobacillus* pokazale su sposobnost proizvodnje egzopolisaharida direktno tijekom kiseljenja tijesta

(Katina i sur., 2005). Pokusi provedeni u ovom istraživanju (Slike 5, 6 i 7) pokazali su da bakterija *Leuc. mesenteroides* također može proizvoditi EPS tijekom kiseljenja tijesta bez značajnog utjecaja na kinetiku kiseljenja i proizvodnju kiselina. HPLC analiza kiselinskog hidrolizata EPS izoliranih iz kiselog tijesta te EPS izoliranih iz kiselog tijesta kojem je na početku kiseljenja dodana saharoza pokazala je da se radi o heteropolisaharidima. Detektirani su monomeri glukoze, ksiloze i arabinoze. U tijestu s dodatkom saharoze povećan je udio glukoze u sastavu EPS što upućuje na zaključak da su detektirani heteropolisaharidi prirodno prisutni polisaharidi brašna, dok *Leuc. mesenteroides* i u brašnu proizvodi dekstran koji u ukupnoj količini EPS povećava udio glukoze. Rezultati prikazani Slikama 4 i 5 pokazuju da je i u tijestu kao i u MRS podlozi optimalno vrijeme kiseljenja oko 18 h, a koncentracija sintetiziranih EPS veća je pri većim koncentracijama saharoze dodane u brašno, dok je optimalna temperatura fermentacije znatno različita od temperature optimalne za sintezu EPS u MRS podlozi. Naime, maksimalna koncentracija od 21,8 mg EPS/g brašna postignuta je pri temperaturi 20 °C i koncentraciji saharoze 110 g/kg brašna, nešto niža koncentracija EPS od 19,7 mg EPS/g brašna postignuta pri temperaturi 10 °C, ali uz dodatak saharoze od 100 g/kg brašna, dok je pri 6 °C sintetizirano 20,1 mg EPS/g brašna dodatkom znatno manje količine saharoze (75 g/kg brašna). Očito je da je jednaku količinu EPS pri nižim temperaturama moguće proizvesti dodatkom manje količine saharoze. Međutim, ako se gleda cjelokupni proces kiseljenja, a ne samo proizvodnja EPS, kao optimalnu temperaturu moglo bi se definirati također 20 °C s obzirom da se pri nižim temperaturama ostvaruje i manja sinteza kiselina (Slika 6).

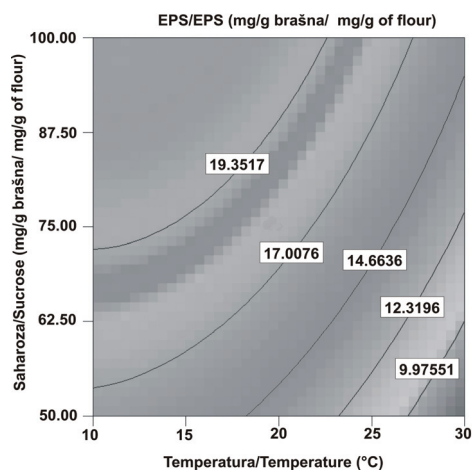

Slika 4. Utjecaj koncentracije saharoze dodane u tijesto i temperature fermentacije na količinu sintetiziranih EPS nakon 18 h fermentacije

Fig. 4. The effect of sucrose concentration in dough and fermentation temperature on the EPS concentration after 18 hours of fermentation

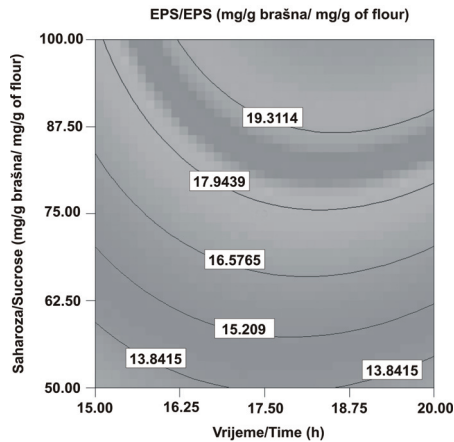

Slika 5. Utjecaj koncentracije saharoze dodane u tijesto i vremena fermentacije na količinu sintetiziranih EPS pri temperaturi 20 °C
Fig. 5. The effect of fermentation time and concentration of sucrose in dough on the EPS concentration at 20 °C

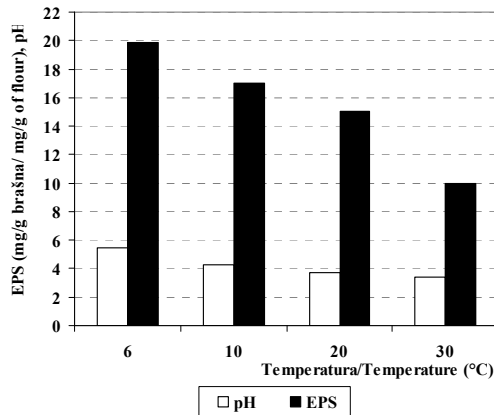

Slika 6. EPS i pH vrijednosti tijesta tijekom kiseljenja tijesta s pomoću *Leuc. mesenteroides* uz dodatak 75 g saharoze/kg brašna pri različitim temperaturama
Fig. 6. EPS and pH of dough during the dough souring with *Leuc. mesenteroides* with addition of 75 g sucrose/kg flour at various temperatures

Navedene vrijednosti količine sintetiziranih EPS u tijestu predstavljaju srednju vrijednost sedam ponovljenih pokusa i greška mjerenja znatno je veća nego kod određivanja koncentracije EPS sintetiziranih u MRS podlozi. To se posebice odnosi na koncentraciju EPS sintetiziranih na 6 °C. I drugi autori navode poteškoće u

određivanju količine EPS sintetiziranih direktno u tijestu (Katina, 2005; Kaditzky i Vogel, 2008). Kao glavni razlog navode se prirodno prisutni EPS u brašnu čija se topivost u vodi mijenja djelovanjem mikrobnih enzima i enzima brašna, kao i sposobnost ekstrakcija sintetiziranih EPS iz tijesta tijekom fermentacije, prvenstveno zbog promjena uzrokovanih sintezom kiselina.

Kako bi se ispitaio utjecaj dodane saharoze na proces kiseljenja tijesta praćene su promjene u koncentraciji fermentabilnih šećera, sintetiziranih metabolita i pH vrijednosti u kontrolnom uzorku bez dodatka saharoze i uz dodatak 5 % saharoze na brašno. U uzorcima tijesta kojima je dodana saharoza nakon 18 h fermentacije zabilježena je veća koncentracija glukoze i fruktoze što pokazuje da sva glukoza nije potrošena za sintezu EPS (Slika 7). Uz dodanu saharozu brašno sadrži još 1-2 % šećera koje kvasci zajedno sa zaostalim šećerima mogu brzo fermentirati. Saharoza osim sinteze EPS *in situ* uzrokuje i sintezu drugih metabolita, kao što su manitol, glukoza i acetat, koji isto tako mogu pridonijeti kvaliteti kruha (Korakli i Vogel, 2006). S druge strane, dodana saharoza ne utječe na sintezu mliječne kiseline.

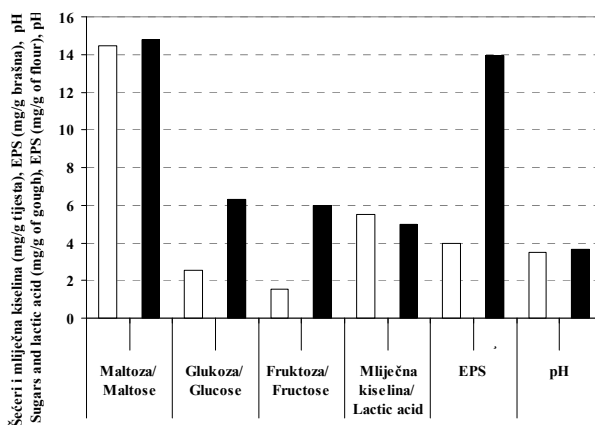

Slika 7. Koncentracija fermentabilnih šećera i sintetiziranih metabolita u kontrolnom uzorku bez dodatka saharoze (prazno) i uz dodatak 5 % saharoze na brašno (puno) nakon 18 h kiseljenja pri 20 °C s pomoću *Leuc. mesenteroides*

Fig. 7. Concentrations of sugars and methabolites, and pH values in dough without (white bars) and with (black bars) the addition of 5 % sucrose in flour, after 18 hours of souring at 20 °C with *Leuc. mesenteroides*

Zaključak

Bakterija *Leuc. mesenteroides*, koja se uobičajeno koristi kao jedna od starter kultura u proizvodnji pekarskih proizvoda, pokazala je sposobnost sinteze EPS kako u MRS podlozi tako i *in situ*, što otvara nove mogućnosti u proizvodnji

kvalitetnijih pekarskih proizvoda bez uporabe aditiva. Pokazalo se da je temperatura od 20 °C u obje podloge optimalna za proizvodnju egzopolisaharida te da saharoza u podlozi stimulira njihovu sintezu. Posebno je važno naglasiti da u odabranim uvjetima tijekom kiseljenja tijesta proizvodnja egzopolisaharida nije utjecala na proizvodnju kiselina.

Literatura

- Bounaix, M.S., Gabriel, V., Morel, S., Robert, H., Rabier, P., Remaud-Siméon, M., Gabriel, B., Fontagné-Faucher, C. (2009): Biodiversity of exopolysaccharides produced from sucrose by sourdough lactic acid bacteria, *J. Agric. Food Chem.* 22, 89-97.
- Brandt, M.J., Roth, K., Hammes, W.P. (2003): Effect of an exopolysaccharides produced by *L. sanfranciscensis* LTH 1729 on dough and bread quality. In: Sourdough from Fundamentals to Application, De Vuyst, L. (ed.), Vrije Universiteit, Brussels, pp. 80.
- Decock, P., Capelle, S. (2005): Bread technology and sourdough technology, *Trends Food Sci. Technol.* 16, 57-64.
- Degeest, B., De Vuyst, L. (2000): Correlation of activities of the enzymes α -phosphoglucosyltransferase, UDP-galactose 4-epimerase, and UDP-glucose pyrophosphorylase with exopolysaccharide biosynthesis by *Streptococcus thermophilus* LY03, *Appl. Environ. Microbiol.* 66, 3519-3527.
- De Vuyst, L., Degeest, B. (1999): Heteropolysaccharides from lactic acid bacteria, *FEMS Microbiol.* 23, 153-177.
- Hucker, G.J., Pederson, C.S. (1930): Studies on the coccaceae XVI. Genus *Leuconostoc*, N.Y. Agr. Expt. Sta. Tech. Bull. 167, 3-8.
- Hrsto, O. (2010): Proizvodnja egzopolisaharida s pomoću bakterije *Leuconostoc mesenteroides*, Diplomski rad, Prehrambeno-bioteknološki fakultet, Zagreb.
- Kaditzky, S., Vogel, R.F. (2008): Optimization of exopolysaccharide yields in sourdoughs fermented by lactobacilli, *Eur. Food Res. Technol.* 228, 291-299.
- Katina, K. (2005): Sourdough: a tool for the improved flavour, texture and shelf-life of wheat bread, Valtion Teknillinen Tutkimuskeskus, Doctoral Thesis, University of Helsinki, Finland.
- Ketabi, A., Soleimani-Zad, S., Kadivar, M., Sheikh-Zeinoddin, M. (2008): Production of microbial exopolysaccharides in the sourdough and its effects on the rheological properties of dough, *Food Res. Int.* 41(10) 948-951.
- Kodali, V.P., Sen, R. (2008): Antioxidant and free radical scavenging activities of an exopolysaccharide from a probiotic bacterium, *Biotechnol. J.* 3, 1-7.
- Korakli, M., Vogel, R.F. (2006): Structure/function relationship of homopolysaccharide producing glycosyltransferases and therapeutic potential of their synthesised glycans, *Appl. Microbiol. Biotechnol.* 71, 790-803.
- Mrvčić, J. (2008): Uvjeti i procesi ugradnje biogenih elemenata u bakterije mliječne kiseline, Disertacija, Prehrambeno-bioteknološki fakultet, Zagreb.
- Pereira-Duta, F., de França, F.P. de Almeida-Lopes, L.M. (2005): Optimization of culture conditions for exopolysaccharides production in *Rhizobium* sp. using the response surface method. Electronic Journal of Biotechnology, Pontificia Universidad Católica de Valparaíso, Chile.

- Petry, S., Furlan, S., Crepeau, M.J., Cerning, J., Desmazeau, M. (2000): Factors Affecting Exocellular Polysaccharide Production by *Lactobacillus delbrueckii* subsp. *bulgaricus* Grown in a Chemically Defined Medium, *Appl. Environ. Microbiol.* 66, 3427-3431.
- Ruas-Madiedo, P., Reyes-Gavilan, C.G. (2005): Methods for the screening, isolation and characterization of exopolysaccharides produced by lactic acid bacteria, *J. Dairy Sci.* 88(3), 843-856.
- Sarwat, F., Qader, S.A.U., Aman, A., Ahmed, N. (2008): Production and Characterization of a Unique Dextran from an Indigenous *Leuconostoc mesenteroides* CMG713, *Int. J. Biol. Sci.* 4, 379-386.
- Semjonovs, P., Jasko, J., Auzina, L., Zikmanis, P. (2008): The Use of Exopolysaccharide-Producing Cultures of Lactic Acid Bacteria to Improve the Functional Value of Fermented Foods, *J. Food Technol.* 6, 101-109.
- Tallgren, A.H., Airaksinen, U., von Weissenberg, R., Ojamo, H., Kuusisto, J., Leisola, M. (1999): Exopolysaccharide-Producing Bacteria from Sugar Beets, *Appl. Environ. Microbiol.* 65(2), 862-864.
- Tieking, M., Korakli, M., Ehrmann, M.A., Gänzle, M.G., Vogel, R.F. (2003): *In situ* production of exopolysaccharides during sourdough fermentation by cereal and intestinal isolates of lactic acid bacteria, *Appl. Environ. Microbiol.* 69, 945-952.

Production and application of bacterial exopolysaccharides in bread-making

J. Mrvčić, O. Hrsto, D. Stanzer, S. Grba, V. Stehlik-Tomas

University of Zagreb, Faculty of Food Technology and Biotechnology, Pierottijeva 6, 10000 Zagreb, Croatia

Summary

Lactic acid bacteria that produce exopolysaccharides are researched to serve as replacements for hydrocolloids, which are used in bread-making and have a positive effect on volume, texture, freshness and shelf life of bread. The aim of this study was to optimize the production process of EPS in MRS medium and *in situ* using bacteria *Leuconostoc mesenteroides*. Analysis of acidically hydrolyzed exopolysaccharides showed that the synthesized exopolysaccharide is homopolysaccharide dextran. The results also showed that the synthesis of exopolysaccharides in MRS medium and dough are related to growth, and that optimal parameters of synthesis are the temperature of 20 °C, process time of 18 h, and the sucrose concentration of 110 g/L. Under these conditions about 15 g/L exopolysaccharides in MRS medium, and about 19 g exopolysaccharides/kg of flour dough during souring was synthesized. Addition of sucrose in order to synthesize exopolysaccharides during the dough souring had no significant effect on the acid production.

Keywords: exopolysaccharides, lactic acid bacteria, bread-making

Antioxidant properties of various solvent extracts of mulberry leaves

UDC: 634.38 : 615.322.07

I. Mujić¹, M. Radojković^{2*}, S. Vidović²,
Z. Zeković², Ž. Lepojević²

¹*Colegium fluminense polytechnic of Rijeka, Carla Hugueas 6, 52440 Poreč, Croatia*

²*Faculty of Technology, Novi Sad, Bulevar Cara Lazara 1, 21000 Novi Sad, Serbia*

Summary

Mulberry (*Morus nigra*) is a fast-growing deciduous plant that grows under different climatic conditions. Reports indicate that mulberry leaves contain proteins, carbohydrates, calcium, iron, ascorbic acid, β -carotene, vitamin B-1, folic acid and vitamin D. They have been shown to possess medicinal properties such as diuretic, hypoglycemic and hypotensive. However, it is only recently that the mechanism of their action has been related to their antioxidant activity. The antioxidant properties, total phenols and total flavonoids contents of methanol, ethanol, acetone and water extracts of mulberry leaves were examined. Drug-solvent extraction ratio was 1:10, 1:20 and 1:30 (w/v). The highest amount of total phenols (72.18 mg CAE/g of dry extract) and total flavonoids (12.26 mg EC/g of dry extract) were achieved for mulberry extracts obtained by 70 % acetone, i.e. water. Antioxidant activities of dry extracts were tested using a standard DPPH procedure and reducing power assay method. Using the same method antioxidant activity of investigated extracts was compared to antioxidant activity of standard antioxidant compound Vitamin C. Extracts obtained by ratio drug: solvent of 1:20 (w/v) were approved the best antioxidant properties of all research.

Keywords: extraction, mulberry extracts, antioxidant components, phenols, flavonoids

Indroduction

All over the world, people depended on herbs for the treatment of various ailments before the advent of modern medicine. Medicinal plants constitute an arsenal of chemicals that could be exploited by human to prevent disease (Kuetz et al., 2009). A great number of aromatic, spicy, medicinal and other plants contain chemical compounds exhibiting antioxidant properties. Numerous studies were carried out on some of these plants, e.g. rosemary, sage, oregano, which resulted in a development of natural antioxidant formulations for food, cosmetic and other applications. However, scientific information on antioxidant properties of various plants, particularly those that are less widely used in culinary and medicine is still rather scarce. Therefore, the assessment of such properties remains an interesting and useful task, particularly for finding new sources for natural antioxidants, functional foods and nutraceuticals (Miliauskas et al., 2004; Ercisli et al., 2007; Urooj et al., 2007).

* ramarija@uns.ac.rs

Mulberry (*Morus nigra*) is a fast-growing deciduous plant that grows under different climatic conditions. Reports indicate that mulberry leaves contain proteins, carbohydrates, calcium, iron, ascorbic acid, β -carotene, vitamin B-1, folic acid and vitamin D (Urooj et al., 2007). Apart from their use as animal and insect feed, they have been shown to possess medicinal properties such as diuretic, hypoglycemic and hypotensive activities (Kelkar et al., 1996). However, it is only recently that the mechanism of their action has been related to their antioxidant activity. The presence of rutin, quercetin, isoquercetin and other flavonoids in mulberry leaves have been reported (Zhishen et al., 1999). The total antioxidant activity of plant foods is the result of individual activities of each of the antioxidant compounds present such as vitamin C, tocopherols, carotenoids, and phenolic compounds, the latter being the major phytochemicals responsible for antioxidant activity of plant materials (Javanmardi et al., 2003; Pizzale et al., 2002).

The aim of this study was to determine a content of some active components and evaluate antioxidant properties in different solvent mulberry extracts. Investigation included determination of total phenols and flavonoids, the scavenging activity on DPPH radicals and reducing power of extracts.

Materials and methods

Chemicals

1, 1-Diphenyl-2-picryl-hydrazyl-hydrate (DPPH), Folin Ciocalteu folin reagents, chlorogenic acid, catechin and ascorbic acid reagent were purchased from Sigma (Sigma-Aldrich GmbH, Sternheim, Germany). Trichloroacetic acid was purchased from Carloerba (Carloerba, Milano, Italy). Ferrum trichloratum, aluminium chloride-6-hydrate, sodium hydroxide, sodium nitrate, di-sodium hydrogenphosphate, sodium dihydrogenphosphate, sodium carbonate anhydrous, potassium ferricyanide were purchased from Centrohem (Centrohem, Stara Pazova, Serbia). All other chemicals and reagents were of analytical reagent grade.

Materials

Mulberry (*Morus nigra*) leaves were harvested in June 2009 from the Institute for Medicinal Plant Research “Dr. Josif Pančić”, Serbia. Samples were grounded in blender before the extraction. Mean particle size ($d=0.3881$ mm) was determined using sieve sets (Erweka, Germany).

Extraction of antioxidants from mulberry leaves

Plant sample (10.0 g) was extracted by 70 % ethanol, 70 % methanol, 70 % acetone or water as a solvent. Drug-solvent extraction ratio was 1:10, 1:20 and 1:30 (w/v). The extraction process was carried out using ultrasonic bath (B-220, Branson and

Smith-Kline Company, USA) at the room temperature for 1 hour. After filtration, 5 ml of liquid extract was used for extraction yield determination. Solvent was removed by rotary evaporator (Devarot, Elektromedicina, Ljubljana) under vacuum, and was dried at 60 °C to the constant mass. Dry extracts were stored in the glass bottles at - 4 °C to prevent oxidative damage until analysis.

Determination of extraction yield

After extraction process, 5 ml of liquid extract was used for extraction yield determination. Solvent was removed by rotary evaporator (Devarot, Elektromedicina, Ljubljana) under vacuum, and was dried at 105 °C to the constant mass. Extraction yield was expressed as g of yield per 100 g of plant (%).

Determination of total phenols content

The content of total phenolic (TP) compounds in investigated mulberry dry extracts, were determined by Folin-Ciocalteu procedure by Kahkonen (1999) using chlorogenic acid as a standard. The absorbance measurements were performed using a JANWAY 6300 VIS-spectrophotometer, at 765 nm. The standard diagram was prepared with standard chlorogenic acid solutions. Total phenolic compounds content has been expressed as mg of chlorogenic acid equivalent (CAE) per g of dry extract - mg CAE/g.

Determination of total flavonoids content

Determination of flavonoids content was performed using a modified colorimetric method by Jia (1999). The absorbance measurements were performed using a JANWAY 6300 VIS-spectrophotometer, at 510 nm. The standard diagram was prepared with standard catechin solutions. The flavonoids contents were expressed as mg catechin equivalent (CE) per g of dry extract-mg CE/ g.

DPPH assay

The free radical scavenging activity of mulberry extracts was determined as described by Espin (2000). Radical scavenging capacity (% RSC) was calculated by following equation:

$$\%RSC = 100 - \frac{A_{sample}}{A_{blank}} \cdot 100$$

where:

A_{sample} is absorbance of sample solution and
 A_{blank} is absorbance of blank sample.

This activity was also expressed as the inhibition concentration at 50 % (IC₅₀), the concentration of test solution required to give 50 % of decrease in absorbance compared to the blank sample.

Determination of reducing power

The reducing power of mulberry extracts and ascorbic acid were determined by Oyaizu method (1986). Absorbance of samples was measured at 700 nm. Higher absorbance indicates a higher reducing power and higher antioxidant activity.

Results and discussion

It is believed that the natural antioxidants have an important role in the prevention and treatment of many diseases (Hollman at al., 1999). Antioxidants can enter the body through food or food supplements in order to preserve the health of diseases such as cancer, cardiovascular and inflammatory diseases (Shi at al., 2005). Mulberry leaves have antihyperglycemic effect because of the presence of a α -glucosidase inhibitor, 1-deoxynojirimycin and, and fagomine, which potentiates glucose-induced insulin secretion. The mulberry leaf extract has neuroprotective effects, and it can be used as a skin whitening agent and antiinflammatory compound (Choi and Hwang, 2005). Isoquercitrin, rutin, and quercetin 3-(6-malonylglucoside) in the mulberry leaf ethanol extract are able to inhibit low-density lipoprotein oxidation (Doi at al., 2003; Enkhmaa at al., 2005; Katsube at al., 2006). Rutin is the major compound in the mulberry leaf ethanol extract (Lee at al., 2008). Mulberry leaves are now widely consumed as tea infusion. Increased popularity in the intake of plant-based food antioxidants has prompted extensive research on their absorption and bioavailability in both human and animals. Studies on the bioavailability of dietary antioxidants, which provide evidence of the efficacy of antioxidants in the body, are more relevant than those that just report on their in vitro antioxidant properties. However, most studies involved the use of high-dose antioxidants, which range from 50 to 250 mg (Lee at al., 2008).

Extraction yield, total phenol content and flavonoid content in mulberry extract

The yield, total phenols (mg CAE/g) and total flavonoids (mg CE/g) data for different extracts from mulberry leaves are shown in table 1. Extraction yield were different, for different solvents and applied it depends on their polarity. The highest yield was given by water as solvent (25.17 %), as expected, due to the extraction of impurities. Also, apply different ratio drug: solvent influenced the extraction yield and total phenol content and flavonoid content. The highest content of total phenols was determined for *Morus nigra* extract obtained by acetone (72.18±2.46 mg CAE/g). At the other hand, the highest content of total

flavonoids was obtained by water as extraction solvent (12.26±0.92 mg CE/g). Drug: solvent extraction ratio 1:20 has proven to be acceptable for further testing.

Table 1. Extraction yield, total phenol content (TP), and flavonoid (TF)

Mulberry sample	Drug-solvent extraction ratio (w/v)	Extraction yield (% w/w)	TP mg CAE/g	TF mg CE/g
Methanol	1:10	15.04	59.49±3.21	8.92±0.63
	1:20	16.95	69.16±1.89	9.46±0.20
	1:30	17.11	66.90±2.64	10.43±0.71
Ethanol	1:10	12.88	57.60±1.85	9.17±1.25
	1:20	13.62	70.99±1.07	10.86±0.30
	1:30	14.83	69.16±1.18	10.39±0.49
Acetone	1:10	11.46	67.30±2.22	9.41±0.71
	1:20	12.64	72.18±2.46	11.65±0.84
	1:30	14.33	68.53±1.35	12.11±0.72
Water	1:10	21.82	52.15±0.89	11.20±1.28
	1:20	21.91	58.99±1.60	12.26±0.92
	1:30	25.17	49.66±1.50	12.16±1.82

Antioxidant activity of mulberry extracts

The method of scavenging the stable DPPH* radical is widely used method to evaluate antioxidant activity in relatively short time compared to some other methods. DPPH* is a stable free radical and it accepts an electron or hydrogen radical to become a stable diamagnetic molecule (Singleton and Rosi, 1965). The highest value of radical scavenging capacity was achieved for mulberry extract obtained by acetone as extraction solvent, 13.03, 37.50, 67.25 and 89.73 % for extract concentrations of 0.002, 0.005, 0.01 and 0.02 mg/ml, respectively. Radical scavenging activity was found to exhibit 50 % of inhibition value (IC₅₀ value) at the different extract concentration shown in table 2. Based on the results, it can be seen that all mulberry extract reach the value of IC₅₀ lower than of 0.01 mg/ml, indicating high antioxidant activity of all investigated extracts.

Table 2. IC₅₀ value of mulberry extracts

Mulberry sample	Drug-solvent extraction ratio (w/v)	IC ₅₀ [mg/ml]
Methanol	1:20	0.0078
Ethanol	1:20	0.0099
Acetone	1:20	0.0071
Water	1:20	0.0097

Different studies have indicated that the electron donation capacity (reflecting the reducing power) of bioactive compounds is associated with antioxidant activity (Siddhuraju at al., 2002; Yen at al., 1993). In this assay, the ability of extracts to reduce iron (III) to iron (II) was determined and compared to that of ascorbic acid, which is known to be a strong reducing agent. All the extracts showed some degree of electron donation capacity in a concentration-dependent manner, but the capacities were inferior to that of ascorbic acid (Fig. 1). Acetonic extract containing the highest amount of total phenolics, was the most potent reducing agent, where as water extract containing the least amount of phenolics, was the weakest in the activity. Similar relations between iron (III) reducing activity and total phenol content have been reported in the literature (Benzie at al., 1999; Gao at al., 2000; Zhu at al., 2002); however the correlation may not be always linear (Yildirim at al., 2000).

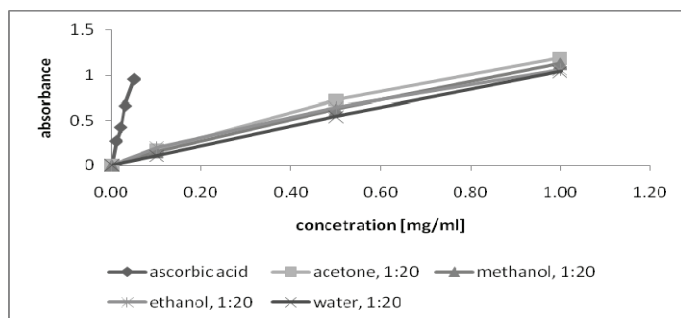

Fig. 1. Reducing power of ascorbic acid and mulberry extract using different solvent, by spectrophotometric detection of $\text{Fe}^{3+} \rightarrow \text{Fe}^{2+}$ transformation

Conclusions

All mulberry extracts showed high contents of antioxidant component and antioxidant activity. Extraction yield were different, for different solvents and depends on their polarity. Also, apply different ratio drug: solvent influenced the extraction yield and total phenol content and flavonoid content. The highest extraction yield was given by water as solvent. The highest content of total phenols was determined for extract obtained by acetone. At the other hand, the highest content of total flavonoids was obtained by water as extraction solvent. Acetonic extract containing the highest amount of total phenolics, was the most potent reducing agent, where as water extract containing the least amount of phenolics, was the weakest in the activity. The highest value of radical scavenging capacity was achieved for mulberry extract obtained by acetone as extraction solvent.

The results indicated the mulberry extracts have antioxidant activity. Because of its properties, *Morus nigra* leaves or their extracts obtained by acetone can be used as natural source of antioxidants, i.e. possible constituent in food or pharmaceutical products.

References

- Benzie, I.F.F., Szeto, Y.T., (1999): Total antioxidant capacity of teas by the ferric reducing antioxidant power assay, *Journal of Agricultural and Food Chemistry* 47, 633–636
- Choi, E.M., Hwang, J.K., (2005): Effects of *Morus alba* leaf extract on the production of nitric oxide, prostaglandin E2 and cytokines in RAW264.7 macrophages, *Fitoterapia* 76, 608–613
- Doi, K., Kojima, T., Fujimoto, Y., (2000): Mulberry leaf extract inhibits the oxidative modification of rabbit and human low density lipoprotein, *Biol Pharm Bull* 23, 1066–1071
- Enkhmaa, B., Shiwaku, K., Katsube, T., Kitajima, K., Anuurad, E., Yamasaki, M., (2005): Mulberry (*Morus alba* L.) leaves and their major flavonol quercetin 3-(6-malonoylglucoside) attenuate atherosclerotic lesion development in LDL receptor-deficient mice, *Jour. Nutr.* 135, 729–734
- Ercisli, S., Orhan, E., (2007): Some physico-chemical characteristics of black mulberry (*Morus nigra* L.) genotypes from Northeast Anatolia region of Turkey, *Scientia Horticulturae*, 116 (1), 41–46
- Espin, J.C., Soler-Rivas, C., Wicher, H.J. (2000): Characterization of total free radical scavenger capacity of vegetable oils and oil fractions using 2,2-diphenyl -1-picrylhydrazil radical, *J. Agri. and Food Chemistry*. 48, 648–656.
- Gao, X., Bjork, L., Trajkovski, V., Uggla, M., (2000): Evaluation of antioxidant activities of rosehip ethanol extracts in different test systems, *Journal of Agricultural and Food Chemistry* 80, 2021–2027
- Hollman, P. C. H. and Katan, M. B., (1999): Dietary flavonoids: intake, health effects and bioavailability, *Food Chemistry Toxicol.* 37, 937–942.
- Javanmard, J., Stushnoff, C., Locke, E., Vivanco, J.M., (2003): Antioxidant activity and total phenolic content of Iranian *Ocimum accessions*, *Food Chemistry* 83, 547–550.
- Jia, Z., Tang, M., Wu, Ju., (1999): The determination of flavonoid contents in mulberry and their scavenging effects on superoxide radicals, *Food Chem.* 64, 555–599.
- Kahkonen, M.P., Hopia, A.I., Vuorela, H.J., Rauha, J.P., Pihlaja, K., Kujala, T.S., Heinonen, M. (1999): Antioxidant activity of plant extracts containing phenolic compounds, *J. Agricultural and Food Chemistry* 47, 3954–3962.
- Katsube, T., Imawaka, N., Kawano, Y., Yamazaki, Y., Shiwaku, K., Yamane Y., (2006): Antioxidant flavonol glycosides in mulberry (*Morus alba* L.) leaves isolated based on LDL antioxidant activity, *Food Chemistry* 97, 25–31
- Kelkar, S.M., Bapat, V.A., Ganapathi, T.R., Kaklig, G.S., Rao, P.S., Heble, M.R., (1996): Determination of hypoglycemic activity in *Morus indica* L. (mulberry) shoot cultures, *Current Science* 71, 71–72.

- Kuete, V., Fozing, D.C., Kapche, F.G.D., Mbaveng, A.T., Kuate, J.R., Ngadjui, B.T., Abegaz, B.M., (2009): Antimicrobial activity of the methanolic extract and compounds from *Morus mesozygia* stem bark, *Journal of Ethnopharmacology* 124 (3), 551-555
- Lee, C.Y., Sim, S.M., Cheng, H.M. (2008): Phenylacetic acids were detected in the plasma and urine of rats administered with low-dose mulberry leaf extract, *Nutrition Research* 28 (8), 555-563
- Miliauskas, G., Venskutonis, P.R., Beek, T.A.V., (2004): Screening of radical scavenging activity of some medicinal and aromatic plant extracts, *Food Chemistry* 85, 231-237
- Oyaizu, M. (1986): Studies on product of browning reaction prepared from glucose amine. *Japanese J. of Nutrition* 44, 307-315.
- Pizzale, L., Bortolomeazzi, R., Vichi, S., Uberegger, E., Conte, L.S., (2002): Antioxidant activity of sage (*Salvia officinalis* and *S fruticosa*) and oregano (*Origanum onites* and *O indercedens*) extracts related to their phenolic compound content, *Journal of the Science of Food and Agriculture* 82, 1645-1651.
- Siddhuraju, P., Mohan, P.S., Becker, K., (2002): Studies on the antioxidant activity of Indian Laburnum (*Cassia fistula* L.): a preliminary assessment of crude extracts from stem bark, leaves, flowers and fruit pulp, *Food Chemistry* 79, 61-67
- Singleton, V.L., Rossi, J.A., (1965): Colorimetric of total phenolic with phpsphomolybdic phosphotungstic acid reagens, *Am. J. Enol. Vitic.* 16, 144-158.
- Shi, J., Nawaz, H., Pohorly, J., Mittal, G., Kakuda, Y. And Jiang, Y., (2005): Extraction of polyphenolics from plant material for functional foods- engineering and technology, *Food Rev. Int.* 21, 139-166.
- Urooj, A., Arabshahi-Delouee, S., (2007): Antioxidant properties of various solvent extracts of mulberry (*Morus indica* L.) leaves, *Food Chemistry* 102 (4), 2007, 1233-1240
- Yen, G.C., Duh, P.D., Tsai, C.L., (1993): Relationship between antioxidant activity and maturity of peanut hulls, *Journal of Agricultural and Food Chemistry* 41, 67-70
- Yildirim, A., Mavi, A., Oktay, A.A., Algur, O.F., Bilaloglu, V., (2000): Comparison of antioxidant and antimicrobial activity of tilia (*Tilia argenta* Desf. Ex. D.C.), sage (*Salvia triloba* L.) and black tea (*Camellia sinensis* L.) extracts, *Journal of Agricultural and Food Chemistry* 48, 5030-5034
- Zhishen, J., Mengcheng, T., Jianming, W., (1999): The determination of flavonoid contents in mulberry and their scavenging effects on superoxide radicals, *Food Chemistry* 64, 555-559.

Shelf-life of fresh-cut pears processed after harvest and storage in controlled atmosphere

UDC: 634.13 : 664.8.035

N. Nedić Tiban*, V. Piližota, I. Rendić

*University of Josip Juraj Strossmayer in Osijek, Faculty of Food Technology Osijek,
Franje Kuhača 20, 31000 Osijek, Croatia*

Summary

The aim of this work was to investigate the effect of condition of raw material and different agents on shelf-life of fresh-cut pears *Packham's Triumph* variety. Treatments were obtained with pear fruits after harvest and after six months of controlled atmosphere storage. Colour and texture measurements, as well as visual evaluation of untreated and samples treated with different agents, during sixteen days of storage at 4 °C, were carried out. Fresh-cut pear slices were dipped for 2 minutes in water solution of hydrogen peroxide (HP), potassium sorbate (PS), ascorbic acid (AA), calcium ascorbate (CaA), sodium hexametaphosphate (SHMP), calcium chloride (CaC), and combinations of AA with SHMP (2 % AA + 1 % SHMP, 2 % AA + 2 % SHMP, 3 % AA + 1 % SHMP, 3 % AA + 2 % SHMP) and calcium chloride (2 % AA + 0.2 % CaC, 3 % AA + 0.2 % CaC). The shelf-life of fresh-cut pears (prepared from pears after harvest) could be prolonged, depending on treatment, on about 12 to 16 days (the best treatment was 2 % AA + 0.2 % CaC). Shelf-life of samples, prepared from fruit stored in controlled atmosphere for 6 months was approximately 8 days, except for samples treated with 1 % calcium ascorbate (12 days). Addition of calcium (calcium ascorbate) significantly prevented tissue breakdown of samples during storage at 2 °C. Quality of minimally processed fruits depends on fruit (raw material) quality during prolonged storage.

Keywords: pears, colour, texture, shelf-life

Introduction

The beneficial effect of controlled atmosphere storage (CA) for whole fruits has been well documented and is widely employed throughout food industry. CA storage of fruits and vegetables not only increases the shelf-life of these products and maintains good quality but also allows a consistent year-round supply in the marketplace.

Pear is a popular and commercially important fruit served as a fresh-cut item. With CA storage pears can be stored longer while retaining higher quality and reducing losses as compared to storage in a normal atmosphere (Kader, 1992; Ma and Chen, 2003). The effect of such storage of intact fruits on the subsequent shelf-life of the fresh-cut fruit is not well known (McLellan et al., 1990; Gorny et al., 2000; 2002).

* nela.nedic@ptfos.hr

Gorny et al. (2000) determined that, compared to air storage, CA (2 % O₂ + 98 % N₂) storage at -1 °C of whole mature-green pears extended shelf-life of slices by 1 to 2 days. A significant reduction in shelf-life of slices from pears stored at -1 °C in air and CA, compared to slices from freshly harvested pears was observed. Therefore, it seems beneficial to use CA for off-season pears (as opposed to air-stored) to maximize post-cutting life of slices. Browning is a particular problem in fruit with white flesh such as pear. Chemical dips (such as ascorbic acid, calcium salts and other compounds) have been shown to be effective in retarding browning and softening of fruits such as apple, pear, etc. (Piližota and Sapers, 2004; Oms-Oliu et al., 2010).

The aim of this work was to investigate the effect of different agents on shelf-life of fresh-cut pears *Packham's Triumph* variety immediately after harvest and after 6 months of CA storage. Colour and texture measurements, as well as visual evaluation of untreated and samples treated with different agents, during 16 days of storage at 2 °C, were carried out.

Materials and Methods

Packham's Triumph pears were obtained from a commercial orchard in Slavonia County (Croatia). Pear fruit firmness was measured on pared surfaces on opposite sides of fruit using a fruit pressure tester (McCormick, USA) with an 8 mm diameter tip. Pears selected for treatment had flesh firmness within the range of 58 - 75 N.

After harvest, pears were submitted to pre-cooling in air at 1 °C for 2 weeks before applying CA containing of 2 % O₂ and 1 % CO₂ at 2 °C. After 6 months of CA storage pears were kept for 1 week in air at 2 °C. Chemical analyses were obtained with pear fruits after harvest and after 6 months of CA storage. Total dry matter was obtained by vacuum drying previously prepared pear puree, at 70 °C until constant weight was achieved. Soluble solids were determined at 20 °C by means of a refractometer (Carl Zeiss, Germany). The pH was measured by using a pH meter (Mettler Toledo, Switzerland). Total acidity was measured by titration with 0.1 N NaOH, based on malic acid (AOAC, 1980). The titration AOAC method, using 2,6-dichlorophenol indophenol solution, was used to measure ascorbic acid. Reducing and total sugars were determined by Luff-Schoorl method (AOAC, 1980). Pectic compounds were determined by Carré-Haynes method (Carré and Haynes, 1922). Total phenol content was determined using the Folin-Ciocalteu colorimetric method described by Ough and Amerine (Ough and Amerine, 1988). Antioxidant activity was determined by DPPH assay (Arnao et al., 2001).

Fresh-cut processing

Pears were held at room temperature for ca 1 hr before fresh-cut processing. The pears were sanitized by immersion for 2 minutes in 1000 mg/L Cl₂ solution (total Cl₂ calculated from level of added sodium hypochlorite, adjusted to pH 6.5

with citric acid) and rinsed with tap water before fresh-cut processing. Cutting of pears were performed manually with a knives, into 8 wedges. To minimize browning during sample preparation, the wedges from individual pears were immersed in browning inhibitor solution immediately after cutting, removed with a plastic colander, and pooled until sufficient wedges were accumulated according to the experimental design (each sample containing the wedges from 5 pears). Pear wedges were gently dried by rolling on four layers of absorbent tissue to remove excess liquid from the surface.

Fresh-cut pear wedges were dipped for 2 minutes in water solution of hydrogen peroxide (HP), calcium chloride (CaC), ascorbic acid (AA, Kemika, Croatia), calcium ascorbate (CaA), potassium sorbate (PS, Merck, Germany), sodium hexametaphosphate (SHMP, Fluka, Switzerland), and combinations of AA with SHMP (2 % AA + 1 % SHMP, 2 % AA + 2 % SHMP, 3 % AA + 1 % SHMP, 3 % AA + 2 % SHMP) and CaC (2 % AA + 0.2 % CaC, 3 % AA + 0.2 % CaC). Immediately following treatment (or dipping in water) and dewatering, sets of 8 wedges were stored in plastic bags. Samples were stored at 2 °C for up to 16 days. The colour of pear wedges was evaluated with a Minolta CR-300 tristimulus chromameter (Minolta Camera Co., Japan) using the standard white reflector plate. Results were expressed as L*, a*, and b*, C* and h° values immediately after treatments (0 time), and during storage on day 1, 4, 8, 12 and 16 using the averaging mode with 30 replications. Total colour difference (ΔE) from the control sample (untreated and water treated sample), was used to describe the colour change, immediately after treatment and during storage, by the following equation:

$$\Delta E = ((\Delta L^*)^2 + (\Delta a^*)^2 + (\Delta b^*)^2)^{1/2}.$$

Visual observations of sample appearance (colour, visible structural integrity and general visual appeal) were made by three of the investigators at day 1, 4, 8, 12 and 16.

Firmness of fresh-cut pear wedges was measured on 0, 1, 4, 8, 12 and 16 day using a texture analyser (TA.XT 2, Stable Micro Systems, UK) fitted with a 2 mm diameter probe. The penetration depth was 5 mm and the cross-head speed was 1.5 mm s⁻¹. Ten pieces per replicate were performed for texture measurements.

Results and Discussion

In Table 1, composition parameters and pH of *Packham's Triumph* pear are given. Analyses were performed immediately after harvest and after 6 months of CA storage. Fresh pears had slightly lower values of total dry matter, soluble solids and sugars. Total acidity, content of ascorbic acid and total phenolics, pectic compounds and antioxidant activity of fresh pears was higher compared to pears from CA storage, especially content of ascorbic acid. Results of composition parameters are in accordance with the investigations of other authors (Moya-León et al., 2006).

Table 1. Composition parameters and pH of *Packham's Triumph* pear after harvest and after 6 months of CA storage

Parameter	After harvest	After CA storage
Total dry matter (%)	18.91	20.27
Soluble solids (%)	16.30	18.30
pH	4.04	4.40
Total acidity (%)	0.22	0.17
Ascorbic acid (mg/100 g)	36.36	0.41
Total phenol content (g/L)	1.11	1.06
Pectic compounds (%)	0.82	0.73
Total sugars (%)	10.47	12.30
Reducing sugars (%)	10.00	11.47
Antioxidant activity (mgGAE/100 g)	18.49	5.14

Colour assesment

Colour was recorded using CIE L*a*b* uniform colour space, where L* indicates lightness, a* indicates chromacity on a green (-) to red (+) axis, b* chromacity on a blue (-) to yellow (+) axis, and using L*C*h° colour scale (C* - chroma, intensity of colour, h° - hue angle, actual colour). Sapers and Douglas (1987) reported that enzymatic browning at the cut surfaces of apples could be monitored by measuring changes in reflectance L* and a* values, and that b* values seemed to be unrelated to the extent of browning, which is in agreement with our results.

Since L* is a measure of the colour in the light-dark axis, decreased values indicated that the samples turned darker (data not shown). Fig. 1 and 2 showed that a* parameter tended to increase during storage of both type of fresh-cut pears (fresh-cut pears after harvest, and fresh-cut pears stored for 6 months in CA before preparation of samples). Initial samples (0 day) showed negative a* values in all samples (the smallest values were -4.00 and -3.48 for the samples treated with 2 % and 3 % AA, respectively). After 8 days of storage, a* value increased in all samples and the highest increase was observed in a control samples (around 4.20).

The rate of lightness decrease may be divided into two periods. In the first period, lasting until the 4th day of storage of fresh-cut pears, processed immediately after harvest, the browning (decrease in L* and h° values, and increase of a* value) increased sharply, which could be attributed to the consumption of substrates by polyphenoloxidase (PPO). In the case of pears processed after 6 months of CA storage, sharp decrease in L* and h° values, and increase of a* value was recorded after 1st day of storage. In the second period browning was much slower. The second period for fresh-cut pears, processed immediately after harvest, was observed between 4th and 8th day of storage, and for fresh-cut pears processed after CA storage, between 1st and 4th day of storage.

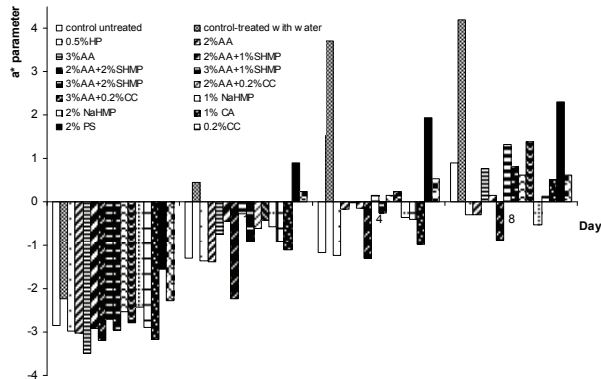

Fig. 1. Effect of different agents and formulations on a* parameter of colour of *Packham's Triumph* pear wedges during 8 day storage at 2 °C (processed after harvest)

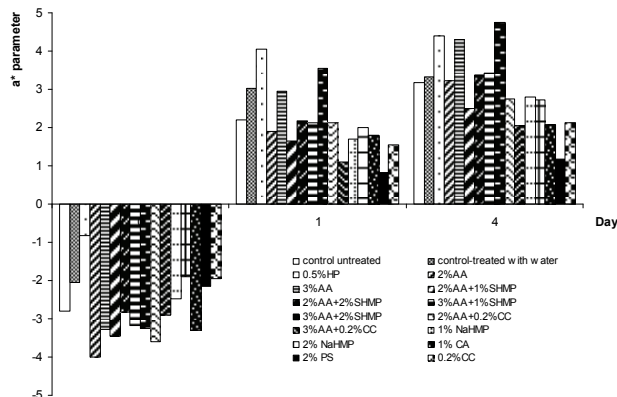

Fig. 2. Effect of different agents and formulations on a* parameter of colour of *Packham's Triumph* pear wedges during 4 day storage at 2 °C (processed after CA storage)

One of the best parameters for describing the colour variation is the colour difference (ΔE). Table 2 shows the variation of this parameter depending on treatment, during storage of fresh-cut samples at 2 °C.

ΔE_{c_u} -colour difference was calculated from L^* , a^* and b^* values of sample for the same day in comparison to control sample (untreated) and ΔE_{c_w} -colour difference was calculated according to control sample (treated with water).

The smallest total colour change (ΔE) had samples treated with 2 % AA + 0.2 % CaC, samples treated with 3 % AA + 2 % SHMP, samples treated with 1 % CaA, etc. Nevertheless, ΔE value was very close to 1 in many cases, which imply almost non-perceptible changes in fresh-cut samples.

Combinations of 2 % AA or 3 % AA and also, 1 % CaA applied as a dip successfully reduced pear wedge surface browning, extending the shelf-life of product. Treatments with browning inhibitor formulations containing SHMP were more effective than treatments without SHMP in suppressing darkening during storage of fresh-cut pears.

Pears treated with combination of 2 % AA + 0.2 % CaC, and 2 % PS solution showed the best results in visual colour evaluation (data not shown).

Table 2. Total colour difference (ΔE) of untreated and treated fresh-cut pears during 8 day storage at 2 °C

Treatment	Day	ΔE_c_u		ΔE_c_w	
		After harvest	After CA	After harvest	After CA
control untreated	0	-	-	3.75	4.82
	1	-	-	6.03	9.84
	4	-	-	12.35	7.73
	8	-	-	10.42	-
control-treated with water	0	3.75	4.82	-	-
	1	6.03	10.20	-	-
	4	12.35	8.03	-	-
	8	10.42	-	-	-
0.5 % HP	0	2.05	7.40	1.83	3.74
	1	2.09	10.75	7.87	2.31
	4	5.00	9.14	14.95	1.72
	8	3.77	-	12.94	-
2 % AA	0	0.90	1.86	3.30	6.47
	1	1.81	5.88	7.77	5.23
	4	3.16	6.62	12.52	2.19
	8	4.39	-	14.25	-
3 % AA	0	3.50	1.53	3.25	6.31
	1	2.11	6.69	4.01	4.05
	4	3.68	9.40	9.42	1.90
	8	4.88	-	6.06	-
2 % AA + 1 % SHMP	0	1.68	1.30	4.06	5.71
	1	2.84	3.65	3.55	6.43
	4	1.63	5.85	10.99	2.27
	8	0.57	-	10.76	-
2 % AA+2 % SHMP	0	2.09	2.49	3.27	6.83
	1	1.93	4.13	7.79	5.74
	4	4.75	6.65	14.82	1.56
	8	4.51	-	14.26	-
3 % AA + 1 % SHMP	0	2.12	2.85	3.01	7.60
	1	2.52	3.58	4.00	7.25
	4	2.68	4.17	10.12	4.75
	8	2.17	-	8.28	-

Treatment	Day	ΔE_{c_u}		ΔE_{c_w}	
		After harvest	After CA	After harvest	After CA
3 % AA + 2 % SHMP	0	0.38	1.33	3.41	6.11
	1	0.56	7.88	6.29	3.59
	4	2.84	9.87	12.15	2.72
	8	1.51	-	9.22	-
2 % AA + 0.2 % CaC	0	1.25	2.14	4.26	6.73
	1	2.05	3.45	4.00	6.56
	4	2.54	3.32	11.42	4.79
	8	1.01	-	9.87	-
3 % AA + 0.2 % CaC	0	1.85	3.52	3.79	7.60
	1	1.81	2.04	4.64	8.89
	4	4.00	2.09	9.87	6.82
	8	2.83	-	8.36	-
1 % SHMP	0	4.33	2.59	2.92	3.13
	1	1.28	2.64	4.83	7.34
	4	3.29	4.34	12.04	4.34
	8	3.78	-	13.52	-
2 % SHMP	0	15.89	2.80	3.90	2.20
	1	22.02	3.93	3.08	6.11
	4	20.78	7.97	11.78	3.55
	8	22.82	-	10.47	-
1 % CaA	0	1.38	2.45	2.68	7.26
	1	1.31	2.34	6.65	8.56
	4	5.45	2.05	13.90	8.39
	8	3.43	-	12.26	-
2 % PS	0	6.75	1.57	3.61	5.34
	1	6.32	2.39	0.70	9.28
	4	6.84	2.61	5.76	7.36
	8	4.93	-	5.73	-
0.2 %CaC	0	4.71	1.58	2.85	5.73
	1	3.45	2.23	2.71	8.16
	4	3.93	2.37	9.90	7.38
	8	1.89	-	11.01	-

ΔE_{c_u} -colour difference was calculated from L*, a* and b* values of sample for the same day in comparison to control sample (untreated)

ΔE_{c_w} -colour difference was calculated according to control sample (treated with water)

Firmness

The large decrease in L* value for most samples was the result of browning and tissue breakdown, which produced a dark and uneven water-logged appearance that may have been due to use of some slightly overripe pears for treatments (especially for pears stored in CA). Changes in fruit flesh firmness during storage at 2 °C are shown in Fig. 3 and 4.

Treatment with CaA and addition of 0.2 % CaC to browning inhibitor formulations containing AA prevented a loss of fresh-cut firmness in comparison to treatment formulations without CaC addition. Calcium salts effect

on cell wall structure and membrane permeability. It interacts with pectin to form a cross-linked polymer network that increases mechanical strength, thus delaying senescence and controlling physiological disorders in fruit.

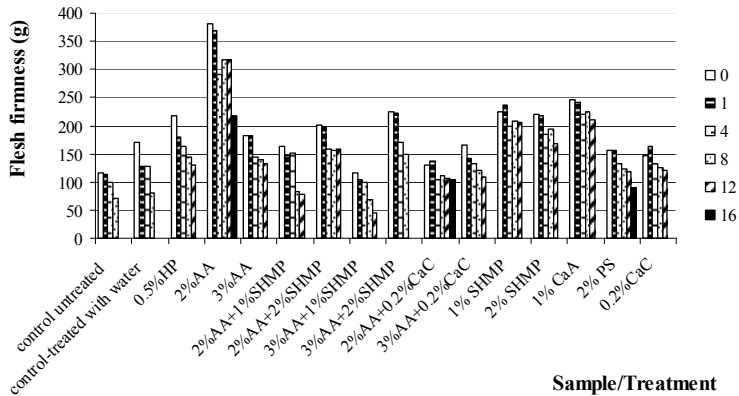

Fig. 3. Effect of treatments on flesh firmness of fresh-cut pears during 16 days storage at 2 °C (processed after harvest)

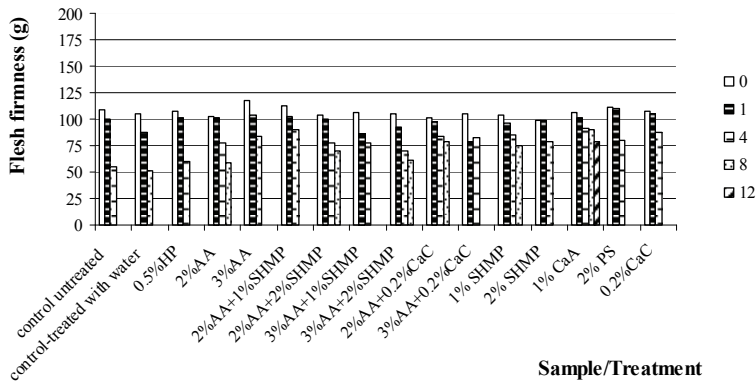

Fig. 4. Effect of treatments on flesh firmness of fresh-cut pears during 12 day storage at 2 °C (processed after CA storage)

The lowest loss of firmness in both types of fresh-cut pears was obtained in samples treated with 0.2 % CaC, combination of 2 % AA + 0.2 % CaC, as well as samples treated with 1 % CaA. The highest loss of firmness in both types of fresh-cut pears was recorded in samples treated with water.

Conclusions

Darkening of fresh-cut pears during storage, manifested in decrease in L* value and h° value, and increase in a* value, resulted from enzymatic browning and

tissue breakdown. Our results showed the effectiveness of ascorbic acid (AA) and calcium chloride (CaC) to preserve minimally processed pears from quality losses. Calcium ascorbate (CaA) treatment and addition of 0.2 % CaC to browning inhibitor formulations containing ascorbic acid prevented a loss of fresh-cut pears firmness in comparison to treatment formulations without CaC addition. The shelf-life of fresh-cut pears (prepared from pears after harvest) could be prolonged, depending on treatment, on about 12 to 16 days (the best treatment was 2 % AA + 0.2 % CaC). Shelf-life of samples, prepared from fruit stored in controlled atmosphere for 6 months was approximately 8 days, except for samples treated with 1 % CaA which was 12 days. Further investigations are required in order to determine the effects of fruit ripeness, variety, storage conditions, and to improve other processing conditions such as packaging methods.

References

- AOAC (1980): Official methods of analysis, 13th Ed. Association of Official Analytical Chemists, Washington DC.
- Arnao, M.B., Cano, A., Acosta, M. (2001): The hydrophilic and lipophilic contribution to total antioxidant activity, *Food Chem.* 73 (2), 239-244.
- Carré, M.H., Haynes, D. (1922): The estimation of pectin as calcium pectate and the application of this method to the determination of the soluble pectin in apples, *Biochem. Jour.* 16, 60-69.
- Gorny, J.R., Cifuentes, A., Hess-Pierce, B., Kader, A.A. (2000): Quality changes in fresh-cut pear slices as affected by cultivar, ripeness stage, fruit size, and storage regime, *J. Food Sci.* 65 (3), 541-544.
- Gorny, J.R., Hess-Pierce, B., Cifuentes, A., Kader, A.A. (2002): Quality changes in fresh-cut pear slices as affected by controlled atmospheres and chemical preservatives, *Postharvest Biol. Technol.* 24, 271-278.
- Kader, A.A (1992): Postharvest Biology and Technology: An Overview. In: Postharvest Technology of Horticultural Crops, Kader, A.A. (ed.), University of California, USA: Division of Agriculture and Natural Resources, Publication 3311, pp. 15-20.
- Ma, S.S., Chen, P.M. (2003): Storage disorder and ripening behavior of “Doyenne du Comice” pears in relation to storage conditions, *Postharvest Biol. Technol.* 28, 281-294.
- McLellan, M.R., Blanpied, G.D., Massey, L.M. (1990): Harvest date and CA storage management effects on quality of processed apple slices, *J. Food Sci.* 55 (4), 1046-1048.
- Moya-León, M.A., Vergara, M., Bravo, C., Montes, M.E., Moggia, C. (2006): 1-MCP treatment preserves aroma quality of “Packhams Triumph” pears during long-term storage, *Postharvest Biol. Technol.* 42, 185-197.
- Oms-Oliu, G., Rojas-Graü, A., Gonzáles, L.A., Varela, P., Soliva-Fortuny, R., Hernando, I.H., Munuera, I.P., Fiszman, S., Martín-Belloso, O. (2010): Recent approaches using chemical treatments to preserve quality of fresh-cut fruit: a review, *Postharvest Biol. Technol.* 57, 139-148.
- Ough, C.S., Amerine, M.A. (1988): *Methods for Analysis of Musts and Wines*, New York, USA: John Wiley and Sons, pp. 187–188, 192–194.
- Sapers, G.M., Douglas, Jr F.W. (1987): Measurement of enzymatic browning at cut surfaces and in juice of raw apple and pear fruits. *J. Food Sci.* 52, 1258–1262, 1285.
- Piližota, V., Sapers, G.M (2004): Novel browning inhibitor formulation for fresh-cut apples, *J. Food Sci.* 69 (4), 140-143.

Reološka svojstva modelnih otopina saharoze, pektina i celuloze kod niskih temperatura

UDC: 539.501 : 547.458

A. Pozderović*, T. Moslavac, A. Pichler, K. Paragović

Sveučilište Josipa Jurja Strossmayera u Osijeku, Prehrambeno-tehnološki fakultet Osijek, Franje Kuhača 20, 31000 Osijek, Hrvatska

Sažetak

Poznavanje reoloških svojstava značajno je za vođenje procesa pri proizvodnji hrane i pri postizanju određenih svojstava hrane. Različiti ugljikohidrati bitni su sastojci velikog broja prehrambenih proizvoda. U ovom radu bio je istraživani utjecaj udjela topljive suhe tvari, netopljive suhe tvari i brzine smicanja na reološka svojstva modelnih otopina saharoze kod niskih temperatura prije zamrzavanja i tijekom zamrzavanja. Pripremljene su modelne otopine saharoze različitih masenih udjela (20 %, 30 % i 40 %) te različite kombinacije modelne otopine saharoze masenog udjela 30 % s dodatkom pektina (0,2 % i 0,4 % (71 % esterifikacije)) i celuloze (1 %, 2 %, 3 % i 4 %). Mjerenja su provedena na rotacijskom viskozimetru s rashladnom jedinicom. Mjerena je ovisnost smičnog naprežanja i smične brzine pri 5 °C i 0 °C; pri konstantnoj brzini smicanja kontinuiranim i stupnjevitim hlađenjem. Rezultati su pokazali da su sve ispitivane otopine čiste saharoze na 5 °C i 0 °C newtonske tekućine. Dodatkom pektina i povećanjem udjela krutih čestica dodatkom celuloze u otopinu saharoze povećava se njezina viskoznost, te ona poprima pseudoplastična svojstva. Stupnjevitim hlađenjem smicanje ispitivanih otopina se odvija pri višim temperaturama hlađenja, dok se kontinuiranim hlađenjem odvija pri nižim temperaturama.

Ključne riječi: reološka svojstva, modelne otopine, niske temperature, saharoza, viskoznost

Uvod

Reologija je znanost koja ima različitu primjenu u proizvodnji i preradi hrane, te općem prihvaćanju hrane (Man i sur., 1975). Poznavanje reoloških svojstava hrane značajno je u izvedbi procesa tečenja, mjerenja stabilnosti procesa, utvrđivanju potrebnih procesnih parametara, te kontroli kvalitete tijekom proizvodnje i skladištenja (Davis, 1973; Kokini, 1987; Rao i sur., 1986). Zbog njihove prehrambene vrijednosti i organoleptičkih svojstava za mnoge je proizvode bitno ponašanje i utjecaj ugljikohidrata na kvalitetu i vođenje procesa u području niskih temperatura. Najčešće se kao dodatci ili zaslađivači koriste različiti monosaharidi i disaharidi (saharozu). Čiste otopine saharoze pokazuju newtonski karakter (Mathlouthi i sur., 1995; Quintas i sur., 2006) do

* andrija.pozderovic@ptfos.hr

koncentracije 78 % (Saggin and Coupland, 2004). Osim šećera često upotrebljavani su i hidrokoloidei kao stabilizatori i sredstva za želiranje. Dodatak hidrokoloida otopinama šećera mijenja njihova reološka svojstva i newtonski karakter (Cancela i sur., 2005; Galmarini i sur., 2010).

Pektin je kompleksan polisaharid, nalazi se u većini biljnih tkiva i voću. Karboksilna skupina pektina često je esterificirana s metanolom. Stupanj esterifikacije (DE) određuje mehanizam želiranja pektina i njegov utjecaj na reološka svojstva (Sato i sur., 2008).

Provedena su brojna istraživanja reoloških svojstava hrane pri niskim temperaturama. Istraživan je utjecaj različitih dodataka, kemijskog sastava hrane i temperatura skladištenja (Rao i sur., 1986; Pozderović i sur., 2005; Šubarić i sur., 2010).

Istraživanje je provedeno u svrhu utvrđivanja utjecaja topljive suhe tvari i netopljive suhe tvari, odnosno krutih čestica (celuloza) i brzine smicanja na reološka svojstva modelnih otopina saharoze kod niskih temperatura prije zamrzavanja i tijekom zamrzavanja.

Materijali i metode

Istraživanja su provedena sa modelnim otopinama saharoze, pektina i celuloze. Pripremljene su modelne otopine saharoze različitih masenih udjela (20 %, 30 % i 40 %), te modelne otopine saharoze masenog udjela 30 % s različitim udjelom pektina (0,2 % i 0,4 % (71 % esterifikacije)) i celuloze (1 %, 2 %, 3 % i 4 %). Modelne otopine pripremljene su otapanjem određene količine navedenih tvari u destiliranoj vodi i neposredno nakon pripreme podvrgnute mjerenju reoloških svojstava pri temperaturama 5 °C i 0 °C, te temperaturama tijekom zamrzavanja. Mjerenja su provedena na rotacionom viskozimetru Rheotest 3 (WEB MLW, Werk Mendingen Sitz Freital, Njemačka) primjenom sustava koncentričnih cilindara. Optočni tekućinski termostat Ultra – Kryostat MK 70 s uređajem za precizno reguliranje i održavanje temperature od 60 °C do – 30 °C je korišten za ohlađivanje uzorka do temperature zamrzavanja.

Reološka svojstva ispitivanih modelnih otopina određena su mjerenjem i grafičkim prikazom ovisnosti smičnog naprezanja (τ) i smične brzine (D) i izračunavanjem koeficijenta konzistencije (k) i indeksa tečenja (n).

Power law model odnosno Ostwald – De Waele-ova jednadžba korištena je za izračunavanje reoloških parametara (Malkin i Isayev, 2006):

$$\tau = k \cdot D^n \quad (1)$$

gdje je: τ - smično naprezanje (Pa), k – koeficijent konzistencije (Pasⁿ), D – smična brzina (s⁻¹) i n – indeks tečenja.

Prividna viskoznost μ (Pas) izračunata je primjenom izraza:

$$\mu = k \cdot D^{(n-1)} \quad (2)$$

Provedena su tri tipa mjerenja. Mjerena je ovisnost smičnog naprezanja i smične brzine pri temperaturama 5 °C i 0 °C, promjena smičnog naprezanja s promjenom temperature i vremena pri konstantnoj brzini smicanja kod kontinuiranog hlađenja i stupnjevitog hlađenja.

Pri konstantnoj temperaturi 5 °C i 0 °C mjerena je ovisnost smičnog naprezanja (τ) i smične brzine (D) od $D = 40,5 \text{ s}^{-1}$ do $D = 1312 \text{ s}^{-1}$ (uzlazno mjerenje). Kod konstantne brzine smicanja tijekom kontinuiranog hlađenja uzorka od 0 °C do temperature pri kojoj je još moguće smicanje utvrđena je temperatura pri kojoj dolazi do naglog povećanja smičnog naprezanja (τ) što se manifestira kao oštar prijelom krivulje. Ta temperatura je označena kao kritična temperatura T_k . Nakon toga se nastavilo hlađenje odnosno pothlađivanje pri čemu je određena najniža temperatura pothlađivanja pri kojoj još dolazi do smicanja (T_m). Kontinuirano hlađenje od 0 °C do temperature zamrzavanja modelnih otopina provedeno je pri konstantnoj smičnoj brzini $D = 1312 \text{ s}^{-1}$, vrijednosti smičnog naprezanja, viskoznosti i temperature očitavane su svakih 1 min, a prije temperature pri kojoj dolazi do naglog porasta smičnog naprezanja (T_k) svakih 30 sekundi. Stupnjevito hlađenje provedeno je u određenom intervalu smične brzine $D = 40,5 - 1312 \text{ s}^{-1}$, mjerenje od 0 °C do neposredno prije temperature T_k , a zatim kontinuirano hlađenje do temperature pothlađivanja pri kojoj još dolazi do smicanja (T_m).

Rezultati i rasprava

Na osnovi rezultata provedenih reoloških mjerenja pri temperaturama 5 °C i 0 °C, ovisno o udjelu topljive i netopljive suhe tvari, utvrđeno je da su sve ispitivane modelne otopine čiste saharoze newtonske tekućine, a ostale modelne otopine (ovisno o udjelu pektina i celuloze) pokazuju blagi prijelaz prema pseudoplastičnim tekućinama ($n < 1$, Tablica 1).

U Tablici 1 prikazani su dobiveni reološki parametri ispitivanih modelnih otopina saharoze, pektina i celuloze pri temperaturama 5 °C i 0 °C. Iz navedene tablice je vidljivo povećanje viskoznosti povećanjem udjela suhe tvari (20 %, 30 % i 40 % saharoze). Viskoznost se kreće od 3,69 mPas za 20 %-tnu modelnu otopinu saharoze do 12,40 mPas za 40 %-tnu otopinu pri 5 °C i od 4,31 mPas za 20 %-tnu modelnu otopinu saharoze do 15,99 mPas za 40 %-tnu otopinu pri 0 °C.

Dodatkom pektina, 0,2 % i 0,4 % (71 % esterifikacije) u 30 %-tnu modelnu otopinu saharoze dolazi do znatnijeg porasta vrijednosti viskoznosti s povećanjem udjela pektina. Povećanje viskoznosti se kreće od 5,90 mPas za 30 %-tnu modelnu

otopinu saharoze, 17,06 mPas za 30 %-tnu otopinu saharoze + 0,2 % pektina i 24,02 mPas za 30 %-tnu otopinu saharoze + 0,4 % pektina, pri temperaturi 5 °C. Dodatak pektina u 30 %-tnu otopinu saharoze uzrokuje prijelaz u nenewtonsku pseudoplastičnu tekućinu ($n < 1$).

Tablica 1. Reološki parametri modelnih otopina u ovisnosti o udjelu topljive i netopljive suhe tvari pri temperaturama 5 °C i 0 °C.

Table 1. Rheological parameters of model solutions in dependance of soluble and insoluble dry solid content at temperatures 5 °C and 0 °C.

Modelna otopina Model solution	T (°C)	k (Pas ⁿ)	n	μ (mPas) pri 1312 s ⁻¹
20 % S	5	0,004	1,00	3,69
	0	0,004	1,00	4,31
30 % S	5	0,006	1,00	5,90
	0	0,007	1,00	7,22
40 % S	5	0,012	1,00	12,40
	0	0,016	1,00	15,99
30 % S + 0,2 % P	5	0,035	0,90	17,06
	0	0,046	0,89	20,70
30 % S + 0,4 % P	5	0,096	0,81	24,02
	0	0,093	0,86	32,94
30 % S + 0,2 % P + 1 % C	5	0,038	0,90	18,69
	0	0,074	0,90	22,77
30 % S + 0,2 % P + 2 % C	0	0,065	0,82	18,25
30 % S + 0,2 % P + 3 % C	0	0,053	0,86	19,23
30 % S + 0,2 % P + 4 % C	0	0,056	0,85	19,38
30 % S + 1 % C	0	0,013	0,92	7,10
30 % S + 2 % C	0	0,012	0,93	7,39
30 % S + 3 % C	0	0,017	0,89	8,45
30 % S + 4 % C	0	0,014	0,93	8,53

S-saharaza; P-pektin; C-celuloza

Reološki parametri: k-koeficijent konzistencije; n-indeks tečenja; μ-prividna viskoznost kod $D=1312 \text{ s}^{-1}$

S-sucrose; P-pectin; C-cellulose

Rheological parameters: k-consistency coefficient; n-flow index; μ-apparent viscosity at $D=1312 \text{ s}^{-1}$

Dodatkom netopljive suhe tvari (celuloza) i povećanjem udjela krutih čestica (1 %, 2 %, 3 % i 4 % celuloze), pri temperaturi 0 °C, viskozitet 30 %-tne otopine saharoze postepeno, neznatno raste. Dodatak celuloze uzrokuje smanjenje

vrijednosti indeksa tečenja ($n < 1$) što ukazuje da modelna otopina blago poprma pseudoplastična svojstva.

Hlađenjem ispitivanih modelnih otopina na temperature u području zamrzavanja dolazi do pothlađivanja do najniže temperature pri kojoj još dolazi do smicanja (T_m). Na Slici 1 i u Tablici 2 prikazani su rezultati dobiveni pri kontinuiranom hlađenju do temperature T_m . Iz podataka u Tablici 2 vidi se da povećanjem udjela topljive suhe tvari (saharoze) tijekom kontinuiranog hlađenja pri konstantnoj brzini smicanja $D = 1312 \text{ s}^{-1}$ dolazi do sniženja temperature T_m i porasta viskoznosti pri temperaturi T_m , a koji iznosi za 20 %-tnu otopinu saharoze 5,82 mPas, za 30 %-tnu otopinu saharoze 11,30 mPas i za 40 %-tnu otopinu saharoze 23,74 mPas.

Iz Slike 1 vidi se da kontinuiranim hlađenjem ispitivanih modelnih otopina osim kod otopine 30 % S + 0,2 % P + 1 % C i otopine 30 % S + 0,2 % P nema naglog povećanja smičnog napreznja i nema loma krivulje u području zamrzavanja. To znači da nije došlo do početka zamrzavanja i stvaranja kristala leda koje uzrokuje pojavu točke T_k i nagli porast smičnog napreznja uz lom krivulje. Kod modelnih otopina 30 % S + 0,2 % P + 1 % C i 30 % S + 0,2 % P dolazi do pojave gdje snižavanje temperature znatno manje utječe na vrijednost smičnog napreznja i prividnu viskoznost sve do trenutka kada je postignuta određena kritična temperatura T_k (lom krivulje) nakon koje dolazi do naglog povećanja smičnog napreznja i viskoznosti, pri tome se temperatura vrlo sporo snižava iako je brzina odvođenja topline ostala ista.

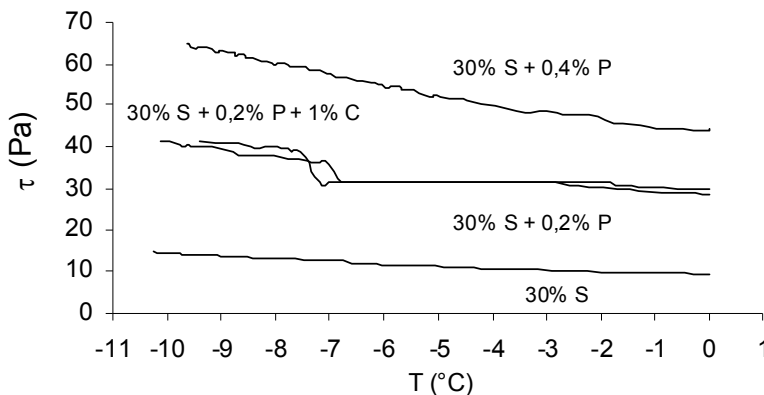

Slika 1. Ovisnost smičnog napreznja (τ) o temperaturi tijekom kontinuiranog hlađenja modelne otopine 30 %-tne saharoze uz dodatak pektina i celuloze

Fig. 1. Shear stress temperature dependance during continuous cooling of 30 % sucrose model solution with addition of pectin and cellulose

Tablica 2. Ovisnost temperature T_k i T_m i viskoznosti o udjelu topljive i netopljive suhe tvari modelnih otopina pri kontinuiranom hlađenju i konstantnoj brzini smicanja ($D = 1312 \text{ s}^{-1}$).

Table 2. Dependence of temperatures T_k and T_m and viscosity of soluble and insoluble dry solid content of model solutions at continuous cooling and constant shear rate ($D = 1312 \text{ s}^{-1}$).

Modelna otopina Model solution	T_k (°C)	T_m (°C)	μ_{T_m} (mPas)
20 % S	-	- 8,75	5,82
30 % S	-	- 10,25	11,30
40 % S	-	- 9,75	23,74
30 % S + 0,2 % P	- 6,80	- 10,10	31,31
30 % S + 0,4 % P	-	- 9,65	49,26
30 % S + 0,2 % P + 1 % C	- 7,20	- 9,40	31,92

S-saharoza; P-pektin; C-celuloza

T_k -temperatura nakon koje dolazi do naglog povećanja smičnog naprezanja i manjeg snižavanja temperature; T_m -najniža temperatura pothlađivanja kod koje još dolazi do smicanja;

μ_{T_m} -viskoznost pri temperaturi T_m

S-sucrose; P-pectin; C-cellulose

T_k -temperature after fast increase of shear stress and lower temperature decrease;

T_m -the lowest sub-cooling temperature at which still shear occurs;

μ_{T_m} -viscosity at T_m temperature

Iz podataka u Tablici 2 i na Slici 1 vidi se da kod veće koncentracije pektina (0,4 %) dolazi do znatno veće vrijednosti viskoznosti pri temperaturi T_m (49,26 mPas), ali nema loma krivulje što znači da nije došlo do početka zamrzavanja i kristalizacije leda.

Stupnjevitim hlađenjem, odnosno zadržavanjem modelnih otopina na pojedinim temperaturama nižim od 0 °C, također su određene temperature za pojedine otopine do kojih je bilo moguće smicanje. U Tablici 3 i na Slici 2 prikazani su rezultati dobiveni pri stupnjevitom hlađenju do temperature T_m . Iz Tablice 3 vidi se da povećanjem koncentracije šećera dolazi do snižavanja temperature T_m do koje je još moguće smicanje. Za 20 %-tnu otopinu saharoze temperatura je – 5 °C, za 30 %-tnu otopinu – 7 °C i za 40 %-tnu – 8 °C. Dodatkom celuloze i povećanjem koncentracije pektina dolazi do povećanja smičnog naprezanja i viskoziteta pri temperaturama u području zamrzavanja, a najniža temperatura kod koje je moguće smicanje je veća kod dodatka pektina 0,4 % (– 7,5 °C) nego kod dodatka pektina 0,2 % (– 9 °C). Također dodatkom 1 % celuloze u 30 %-tnu otopinu saharoze + 0,2 % pektina T_m je viša nego bez dodatka celuloze (– 8 °C u odnosu na –9 °C).

Tablica 3. Ovisnost temperature T_m i smičnog napreznja kod temperature T_m o udjelu topljive i netopljive suhe tvari modelnih otopina pri stupnjevitom hlađenju i konstantnoj brzini smicanja ($D = 1312 \text{ s}^{-1}$).

Table 3. Dependence of temperature T_m and shear stress at temperature T_m of soluble and insoluble dry solid content of model solutions at scale cooling and constant shear rate ($D = 1312 \text{ s}^{-1}$).

Modelna otopina Model solution	T_m (°C)	τ_{T_m} (Pa)	μ_{T_m} (mPas)
20 % S	- 5	6,59	5,02
30 % S	- 7	12,67	9,65
40 % S	- 8	30,89	23,57
30 % S + 0,2 % P	- 9	43,40	36,60
30 % S + 0,4 % P	- 7,5	45,29	59,91
30 % S + 0,2 % P + 1 % C	- 8	51,01	39,08

S-saharoza; P-pektin; C-celuloza

T_m -najniža temperatura pothlađivanja kod koje još dolazi do smicanja; τ_{T_m} -smično napreznje kod temperature T_m ; μ_{T_m} -viskoznost pri temperaturi T_m

S-sucrose; P-pectin; C-cellulose

T_m -the lowest sub-cooling temperature at which still shear occurs; τ_{T_m} -shear stress at temperature T_m ; μ_{T_m} -viscosity at T_m temperature.

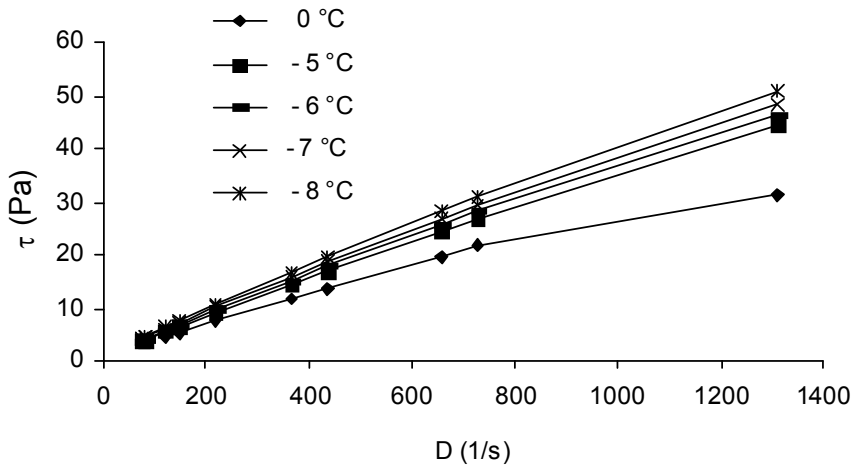

Slika 2. Utjecaj dodatka 0,2 % pektina (71 % esterifikacije) i 1 % celuloze na reološka svojstva 30 %-tne otopine saharoze kod temperatura u području smrzavanja pri stupnjevitom hlađenju

Fig. 2. Influence of 0.2 % pectin (71 % of esterification) and 1 % cellulose addition on rheological properties of 30 % sucrose solution at temperatures in freezing region at scale cooling

Zaključak

Reološkim ispitivanjem modelnih otopina čiste saharoze pri temperaturama 5 °C i 0 °C utvrđeno je da su sve newtonske tekućine. Modelne otopine 30 %-tne saharoze dodatkom pektina i celuloze pokazuju blagi prijelaz prema pseudoplastičnim tekućinama ($n > 1$). Dodatak pektina znatno više utječe na povećanje viskoznosti i na vrijednost indeksa tečenja (n) nego dodatak celuloze. Kontinuiranim i stupnjevitim hlađenjem ispitivanih modelnih otopina saharoze kod konstantne brzine smicanja do niskih temperatura u području zamrzavanja dolazi do pothlađivanja do najniže temperature pri kojoj još dolazi do smicanja (T_m). Temperatura T_m modelne otopine saharoze je niža, a viskoznost otopine veća što je veći udio saharoze.

Kod kontinuiranog hlađenja pri konstantnoj brzini smicanja nekih ispitivanih otopina od 0 °C do temperature T_m utvrđena je kritična temperatura T_k pri kojoj dolazi do naglog povećanja smičnog naprezanja. Kritična temperatura T_k utvrđena je kod modelnih otopina 30 % S + 0,2 % P i 30 % S + 0,2 % P + 1 % C. Stupnjevitim hlađenjem otopine saharoze temperatura T_m je niža, a viskoznost pri toj temperaturi veća, što je udio saharoze veći. Dodatkom većeg udjela pektina kao i dodatkom celuloze temperatura T_m i viskoznost su viši. Stupnjevitim hlađenjem ispitivanih otopina temperature T_m kod kojih je još moguće smicanje su više nego kod kontinuiranog hlađenja.

Literatura

- Cancela M.A., Alvarez E., Maceiras R. (2005): Effects of temperature and concentration on carboxymethylcellulose with sucrose rheology, *J. Food Eng.* 71(4), 419-424.
- Davis S.S. (1973): Rheological properties of semi-solid foodstuffs, *J. Texture Stud.* 4(1), 15-40.
- DeMan J.M., Voisey P.W., Rasper V.F., Stanley D.W. (1975): Rheology and texture in food quality, Avi publishing Company INC Westport
- Galmarini M.V., Baeza R., Sanchez V., Zamora M.C., Chirife J. (2010): Comparison of the viscosity of trehalose and sucrose solution at various temperatures: Effect of guar gum addition, *Food Sci. Technol. - LEB*, 1-5.
- Kokini J.L. (1987): The physical basis of liquid food texture and texture-taste interactions, *J. Food Eng.* 6, 51-81.
- Malkin A.Y., Isayev A.I. (2006): Rheology. Concepts, Methods, and Application, ChemTec Publishing, Toronto, pp. 136-137.
- Mathlouthi M., Genotelle J. (1995): Rheological properties of sucrose solutions and suspensions in Sucrose. Properties and applications, Blackie Academic and Professional, London, pp. 126-154.
- Pozderović A., Moslavac T., Pichler A. (2005): Utjecaj udjela suhe tvari na reološka svojstva kaše jabuke pri niskim temperaturama prije i tijekom smrzavanja, *Kem. Ind.* 54(7-8), 341-346.
- Quintas M., Brandao T.R.S., Silva C.L.M., Cunha R.L. (2006): Rheology of supersaturated sucrose solutions, *J. Food Eng.* 77, 844-852.

- Rao M.A., Cooley H.J., Noguiera J.N., McLellan M.R. (1986): Rheology of Apple Sauce: Effect of Apple Cultivar, Firmness, and Processing Parameters, *J. Food Sci.* 51(1), 176-179.
- Saggin R., Coupland J.N. (2004): Rheology of xanthan/sucrose mixtures at ultrasonic frequencies, *J. Food Eng.* 65(1), 49-53.
- Sato A.C.K., Oliveira P.R., Cunha R.L. (2008): Rheology of Mixed Pectin Solutions, *Food Biophysics* 3(1), 100-109.
- Šubarić D., Babić J., Ačkar Đ., Miličević B., Kopjar M., Slačanac V. (2010): Reološka i termofizikalna svojstva modelnih smjesa za sladoled sa smanjenim udjelom masti i šećera, *Mljekarstvo* 60(2), 127-134.

Rheological properties of sucrose model solutions with pectin and cellulose at low temperatures

A. Pozderović, T. Moslavac, A. Pichler, K. Paragović

University of Josip Juraj Strossmayer in Osijek, Faculty of Food Technology Osijek, Franje Kuhača 20, 31000 Osijek, Croatia

Summary

The knowledge of rheological properties is important for conduction of processes in food production and achieving specific properties of food. The different carbohydrates are important ingredients of many food products.

The aim of this paper was to investigate the influence of soluble dry solid content, insoluble dry solid content and shear rate on rheological properties of sucrose model solutions at low temperatures before and during freezing. Model solutions were made from different mass weights of sucrose (20 %, 30 % i 40 %) and different combinations of model solution of 30 % sucrose with addition of pectin (0,2 % i 0,4 % (71 % esterification)) and cellulose (1 %, 2 %, 3 % i 4 %). Measurements were conducted by rotational viscosimeter with refrigeration unit. Dependence of shear stress and shear rate at 5 °C i 0 °C; at constant shear rate by continuous and scale cooling were measured. Results showed that all examined model solutions of pure sucrose at 5 °C i 0 °C had newtonian character. Pectin and cellulose addition in sucrose model solutions increase viscosity and it becomes pseudoplastic. The shear of investigated solutions was conducted at higher cooling temperatures at scale cooling, while at continuous cooling the temperatures were lower.

Keywords: rheological properties, model solutions, low temperatures, sucrose, viscosity

Utjecaj dodatka pektina na reološka svojstva kaše jabuke pri niskim temperaturama

UDC: 664.292 : 634.11

A. Pozderović*, T. Moslavac, A. Pichler, K. Paragović

*Sveučilište Josipa Jurja Strossmayera u Osijeku, Prehrambeno-tehnološki fakultet
Osijek, Franje Kuhača 20, 31000 Osijek, Hrvatska*

Sažetak

Reološka svojstva hrane bitna su za utvrđivanje procesnih parametara i definiranje senzornih karakteristika pojedinih prehrambenih proizvoda. Kaša jabuke je heterogeni koloidni sustav dobiven pasiranjem prethodno usitnjenog i termički tretiranog voća. U radu je istraživana utjecaj udjela i stupnja esterifikacije pektina, brzine smicanja i brzine hlađenja na reološka svojstva kaše jabuke pri niskim temperaturama, temperaturama prije zamrzavanja i tijekom zamrzavanja. Pripremljena je osnovna kaša jabuke sorte Idared blanširanjem u 10 %-tnoj otopini saharoze koja se koristila za pripremu kaša uz dodatak pektina različitog stupnja esterifikacije (71 % i 62 %) u različitim koncentracijama (0,2 % i 0,4 %). Reološka svojstva mjerena su na rotacijskom viskozimetru s rashladnom jedinicom. Mjerena je ovisnost smičnog naprezanja i brzine smicanja pri temperaturama 0 °C i 5 °C, promjena smičnog naprezanja s promjenom temperature i vremena pri konstantnoj brzini smicanja pri kontinuiranom hlađenju. Određena je najniža temperatura pothlađivanja kod koje još dolazi do smicanja (T_m) i temperatura nakon koje dolazi do naglog povećanja smičnog naprezanja, prividne viskoznosti i manjeg snižavanja temperature (T_k). Dokazano je da su sve ispitivane kaše jabuke newtonske pseudoplastične tekućine. Povećanjem koncentracije pektina višeg stupnja esterifikacije povećava se prividna viskoznost i koeficijent konzistencije; pektin nižeg stupnja esterifikacije ima obrnuto djelovanje. Dodatkom pektina snižava se temperatura zamrzavanja.

Ključne riječi: reološka svojstva, kaša jabuke, niske temperature, pektin

Uvod

Reološka svojstva prehrambenih namirnica vrlo su značajna za razumijevanje promjena u strukturi hrane tijekom različitih procesa proizvodnje i skladištenja (Varela i sur., 2007). Mnoge namirnice, kao što su voćne kaše i umaci su nekohezivne disperzije sastavljene od različitih krutih i tekućih faza. Veličina čestica i njihov oblik u takvim suspenzijama nisu isti i utječu na njihovo kompleksno reološko ponašanje (Cantu-Lozano i sur., 2000). Važan utjecaj također imaju temperatura (Vitali and Rao, 1984) i udio topljive suhe tvari (Ilicali, 1984; Haminiuk i sur., 2006). Brojnim istraživanjima ustanovljeno je da

* andrija.pozderovic@ptfos.hr

se voćne kaše ponašaju kao nenevtonske tekućine (Holdsworth, 1971) što je rezultat složenih interakcija između topivih šećera, pektinskih tvari i suspendiranih krutih čestica (Ahmed i sur., 2004). Općenito, kaše voća i povrća su pseudoplastične (Rao, 1977).

Pektin, polisaharid izgrađen od linearnih lanaca poligalakturonske kiseline, ima svojstvo želiranja i značajno utječe na reološka svojstva voćnih kaša. Stupanj esterifikacije pektina predstavlja udio esterificiranih karboksilnih grupa unutar molekule (Oakenfull, 1991; Rolin, 1993).

Poznavanje reoloških svojstva hrane pri niskim temperaturama (Hegedušić i sur., 2000; Ohnishi i sur., 2004), a posebno u fazi zamrzavanja značajno je radi provedbe i unapređenja procesa zamrzavanja. Provedena su brojna reološka istraživanja na bazi kaše jabuke. Hegedušić i Lovrić (1990) su ispitivanjima na bazi kaše jabuke ustanovili da zamrzavanje, te skladištenje pri niskim temperaturama i odmrzavanje nakon toga uzrokuje smanjenje koeficijenta konzistencije (k) i povećanje indeksa tečenja (n) nakon odmrzavanja ispitivanih sustava što je posljedica promjena u teksturi uvjetovanih faznim prijelazima u procesima zamrzavanja i odmrzavanja. Pozderović i suradnici (2005) su istraživali utjecaj udjela suhe tvari na reološka svojstva kaše jabuke pri niskim temperaturama prije i tijekom zamrzavanja. Qui i suradnici (1988) su istraživali utjecaj postupka prerade jabuke, čvrstoće i veličine čestica na reološko ponašanje kaše jabuke.

Ostwald-De-Waele-ov reološki model ili power law jednadžba koristi se za opisivanje ponašanja sokova i voćnih kaša jer dobro opisuje eksperimentalne podatke, jednostavan je i ima široku tehnološku primjenu (Branco i Gasparetto, 2003).

U radu je istraživana utjecaj dodatka pektina različitog stupnja esterifikacije na reološka svojstva kaše jabuke pri niskim temperaturama uz kontinuirano hlađenje.

Materijali i metode

U ovom radu istraživanja su provedena na kaši jabuke sorte Idared. Osnovna kaša jabuke pripremljena je tako da su jabuke sortirane i vagane, zatim guljene, uklonjene su sjemene lože te su jabuke narezane na kriške približno jednake veličine i blanširane u 10 %-tnoj otopini saharoze, volumena dva puta većeg od mase jabuke (1 kg jabuka/2 L 10 %-tne otopine). Blanširanje je provedeno pri temperaturi od 88 °C u trajanju jednu i pol minutu. Da bi se spriječilo posmeđivanje u otopinu za blanširanje je dodano 1 % askorbinske kiseline (Kemig d.o.o., Hrvatska). Blanširane kriške jabuke pasirane su na laboratorijskoj pasirci (CTC, Njemačka) te je u tako dobivenu kašu još dodano askorbinske kiseline (2 g askorbinske kiseline/1 kg kaše). U osnovnu kašu jabuke dodan je pektin (Obipectin, Švicarska) različitog stupnja esterifikacije (71 % SE i 62 % SE) u koncentracijama 0,2 % i 0,4 %.

Mjerenja reoloških svojstava provedena su na rotacijskom viskozimetru RHEOTEST 3 WEB MLW PRUFGERATE – WERK MENDINGEN/SITZ FREITAL, primjenom sustava koncentričnih cilindara. Rheotest 3 odlikuje se širokim mjernim područjem smičnog naprezanja, smične brzine i viskoznosti. Ohlađivanje uzorka do temperature zamrzavanja provedeno je pomoću optoćnog tekućinskog termostata Ultra-Kryostat MK 70, MLW s uređajem za precizno reguliranje i održavanje temperature od 60 °C do – 30 °C (max. odstupanje temperature $\pm 0,02$ °C).

Mjerenjem reoloških svojstava utvrđeno je na osnovi ovisnosti smičnog naprezanja i brzine smicanja da su sve kaše jabuke pseudoplastične tekućine. Stoga su reološki parametri koeficijent konzistencije (k) i indeks tečenja (n) izračunati primjenom Ostwald De-Waele-ovog "stupnjevitog zakona":

$$\tau = k \cdot D^n \quad (1)$$

gdje je: τ - smično naprezanje (Pa), k – koeficijent konzistencije (Pasⁿ), D – smična brzina (s⁻¹) i n – indeks tečenja.

Prividna viskoznost μ (Pas) izračunata je primjenom izraza:

$$\mu = k \cdot D^{(n-1)} \quad (2)$$

Provedena su dva tipa mjerenja. Mjerenje ovisnosti smičnog naprezanja (τ) i brzine smicanja (D) pri temperaturama 5 °C i 0 °C i mjerenje promjene smičnog naprezanja (τ) s promjenom temperature i vremena pri konstantnoj brzini smicanja ($D=1312$ s⁻¹) i kontinuiranim hlađenjem.

Prvi tip mjerenja proveden je mjerenjem smične brzine u intervalu od $D = 40,5$ s⁻¹ do maksimalno moguće smične brzine $D = 1312$ s⁻¹ za ispitivani sustav pri konstantnoj temperaturi (5 °C i 0 °C).

Kontinuirano hlađenje provedeno je pri konstantnoj smičnoj brzini $D= 1312$ s⁻¹ uz konstantno hlađenje od 0 °C do najniže temperature pothlađivanja kod koje još dolazi do smicanja (T_m). Vrijednosti za smično naprezanje, viskoznost i temperaturu očitavane su svakih pola minute neposredno prije temperature na kojoj dolazi do naglog porasta vrijednosti smičnog naprezanja (T_k). Za svaki uzorak provedena su tri mjerenja svih ispitivanih parametara. Provedena je i kemijska analiza ispitivanih kaša (maseni udio Ca-pektata, netopljive i topljive suhe tvari i ukupnih kiselina).

Rezultati i rasprava

Kemijski sastav ispitivanih kaša jabuke prikazan je u Tablici 1.

Tablica 1. Kemijski sastav ispitivanih kaša jabuke
Table 1. Chemical composition of examined apple puree

Uzorak Sample	Ca-pektat Ca-pectat w(%)	Netopljiva tvar Insoluble content w(%)	Topljiva tvar Soluble content w(%)	Ukupne kiseline Total acids (mmol/100g)
Osnovna kaša jabuke Basic apple puree	0,6583	1,5499	10,50	3,9
Osn. kaša jabuke+0,2% P1 Basic apple puree+0,2% P1	0,7386	2,2177	10,40	3,3
Osn. kaša jabuke+0,4% P1 Basic apple puree+0,4% P1	0,7035	2,111	9,20	3,4
Osn. kaša jabuke+0,2% P2 Basic apple puree+0,2% P2	0,6276	1,811	10,75	3,3
Osn. kaša jabuke+0,4% P2 Basic apple puree+0,4% P2	0,7479	1,892	10,10	4,3

P1- pektin 71 % SE(stupanj esterifikacije); P2- pektin 62 % SE (stupanj esterifikacije)
P1- pectin 71 % SE (esterification stage); P2- pectin 62 % SE (esterification stage)

Dodatkom pektina u osnovnu kašu jabuke povećao se udio netopljive tvari kod svih ispitivanih kaša, dok se udio topljive tvari neznatno smanjio, osim kod kaše s dodatkom 0,2 % pektina 62 % SE. Udio Ca-pektata se povećao, osim kod kaše s dodatkom 0,2 % pektina 62 % SE. U uzorku osnovne kaše jabuke uz dodatak 0,4 % pektina 62 % SE ukupne kiseline su se povećale u odnosu na ostale kaše gdje je došlo do njihovog smanjenja u odnosu na osnovnu kašu. Rezultati mjerenja reoloških svojstava ispitivanih kaša jabuke pri temperaturama 5 °C i 0 °C te izračunati reološki parametri prikazani su u Tablici 2. Iz njih je utvrđeno da su sve ispitivane kaše jabuke pokazivale pseudoplastična svojstva. Pri istoj vrijednosti brzine smicanja ($D = 437,00 \text{ s}^{-1}$), pri temperaturi 5 °C sve ispitivane kaše jabuke imaju niže vrijednosti prividne viskoznosti (μ_p) i koeficijenta konzistencije (k) nego pri temperaturi 0 °C na kojoj su te vrijednosti veće. Vrijednosti indeksa tečenja (n) se ne mijenjaju značajno sniženjem temperature s 5 °C na 0 °C.

Prema podacima u Tablici 2 vidi se da se dodatkom oba ispitivana pektina u osnovnu kašu jabuke smanjila prividna viskoznost i koeficijent konzistencije dok se indeks tečenja povećao u odnosu na osnovnu kašu jabuke.

Tablica 2. Reološki parametri ispitivanih kaša jabuke, pri temperaturama 5 °C i 0 °C
Table 2. Rheological parameters of examined apple purees at temperatures 5 °C and 0 °C

Uzorak Sample	T (°C)	k (Pas ⁿ)	n	R ²	μ pri 437 1/s (mPas)	Tip tekućine Flow behaviour
Osnovna kaša jabuke Basic apple puree	5	31,20	0,195	0,96	263,75	pseudoplastična pseudoplastic
	0	32,96	0,196	0,93	279,51	
Osn. kaša jabuke+ 0,2% P1 Basic apple puree+ 0,2% P1	5	14,20	0,292	0,99	190,86	pseudoplastična pseudoplastic
	0	17,40	0,281	0,99	217,31	
Osn. kaša jabuke+ 0,4% P1 Basic apple puree+ 0,4% P1	5	18,13	0,299	0,97	249,16	pseudoplastična pseudoplastic
	0	20,80	0,292	0,97	270,03	
Osn. kaša jabuke+ 0,2% P2 Basic apple puree+ 0,2% P2	5	15,44	0,265	0,99	176,58	pseudoplastična pseudoplastic
	0	17,01	0,263	0,99	192,38	
Osn. kaša jabuke+ 0,4% P2 Basic apple puree+ 0,4% P2	5	11,38	0,327	0,99	193,15	pseudoplastična pseudoplastic
	0	13,19	0,323	0,99	212,15	

P1- pektin 71 % SE (stupanj esterifikacije); P2- pektin 62 % SE (stupanj esterifikacije)

Power – law parametri: k-koeficijent konzistencije; n-indeks tečenja; R2-koeficijent determinacije;

μ-prividna viskoznost

P1- pectin 71 % SE (esterification stage); P2- pectin 62 % SE (esterification stage)

Power –law parameters: k-consistency coefficient; n-flow index; R2-correlation coefficient;

μ-apparent viscosity

Međutim, povećanjem udjela pektina 71 % SE i pektina 62 % SE s 0,2 % na 0,4 % povećavaju se vrijednosti prividnog viskoziteta pri konstantnoj brzini smicanja $D = 437,00 \text{ s}^{-1}$, pri 5 °C i 0 °C. Povećanjem udjela pektina s 0,2 % na 0,4 % koeficijent konzistencije (k) se kod pektina 71 % SE povećava sa 14,20 Pasⁿ na 18,13 Pasⁿ pri temperaturi 5 °C i sa 17,4 Pasⁿ na 20,8 Pasⁿ pri temperaturi 0 °C. Povećanjem udjela pektina 62 % SE koeficijent konzistencije se smanjuje sa 15,44 Pasⁿ na 11,38 Pasⁿ pri temperaturi 5 °C i sa 17,0 Pasⁿ na 13,19 Pasⁿ pri temperaturi 0 °C. Indeks tečenja (n) se povećanjem udjela pektina 71 % SE ne mijenja značajno dok se povećanjem udjela pektina 62 % SE povećava kod obje temperature. Pri konstantnoj brzini smicanja tijekom kontinuiranog hlađenja uzorka od 0 °C do temperature na kojoj je još moguće smicanje utvrđena je temperatura nakon koje dolazi do naglog povećanja smičnog naprezanja (τ) što se manifestira kao oštar prijelom krivulje (Slika 1). Ta temperatura je označena kao kritična temperatura T_k . Pri temperaturi T_k vjerojatno dolazi do kristalizacije i nastajanja kristala leda uslijed čega se naglo povećava smično naprezanje (τ) pri konstantnoj brzini smicanja. Nakon toga se nastavilo hlađenje odnosno pothlađivanje pri čemu je utvrđena najniža temperatura pothlađivanja kod koje još dolazi do smicanja (T_m). Do temperature T_m kaše su imale viskozna svojstva zbog čega je moguće smicanje, a pri temperaturi T_m prelaze iz viskoznog u kruti plastični materijal zbog čega više nije moguće smicanje. Na Slici 1 i u Tablici 3 prikazan je utjecaj dodatka pektina na reološka svojstva ispitivanih kaša jabuke i utjecaja na temperature T_k i T_m pri kontinuiranom hlađenju i pri konstantnoj brzini smicanja. Iz podataka na Slici 1 vidi se

da se dodatkom pektina u kašu jabuke povećava smično naprezanje (τ) pri niskim temperaturama i konstantnoj brzini smicanja. Smično naprezanje se također povećava povećanjem udjela pektina i stupnja esterifikacije. Iz Tablice 3 i Slike 1 vidi se da su dodatkom pektina u kašu jabuke temperature T_k i T_m više. Te temperature su više i ako je udio pektina veći.

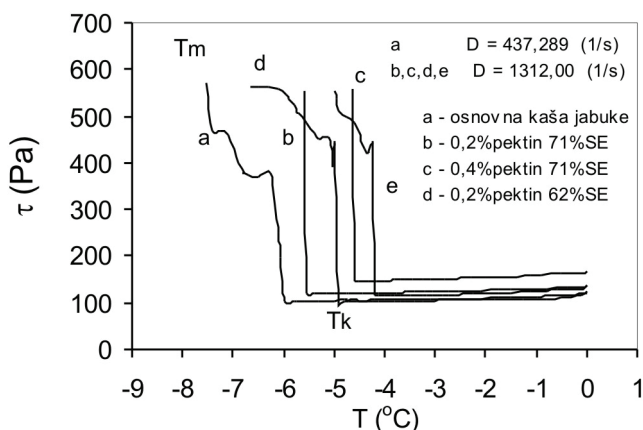

Slika 1. Utjecaj dodatka pektina osnovnoj kaši jabuke na smično naprezanje (τ) i temperature T_k i T_m , tijekom kontinuiranog hlađenja pri konstantnoj brzini smicanja

Fig. 1. Influence of adding pectin in basic apple puree on shear stress (τ) and temperatures T_k i T_m , during continuous cooling at constant shear rate

Tablica 3. Utjecaj dodatka pektina u kašu jabuke na temperature T_k i T_m kod kontinuiranog hlađenja
Table 3. Influence of adding pectin in apple puree on temperatures T_k and T_m at continuous cooling

Uzorak Sample	D(1/s)	T_k (°C)	T_m (°C)
Osnovna kaša jabuke Basic apple puree	437,289	-6,0	-7,25
Osn. kaša jabuke+ 0,2% P1 Basic apple puree+ 0,2% P1	1312,00	-5,5	-5,6
Osn. kaša jabuke+ 0,4% P1 Basic apple puree+ 0,4% P1	1312,00	-4,6	-4,65
Osn. kaša jabuke+ 0,2% P2 Basic apple puree+ 0,2% P2	1312,00	-4,9	-6,65
Osn. kaša jabuke+ 0,4% P2 Basic apple puree+ 0,4% P2	1312,00	-4,2	-5,0

P1- pektin 71 % SE (stupanj esterifikacije); P2- pektin 62 % SE (stupanj esterifikacije);
 D-brzina smicanja; T_k -temperatura nakon koje dolazi do naglog povećanja smičnog naprezanja i
 manjeg snižavanja temperatura; T_m -najniža temperatura pothlađivanja kod koje još dolazi do smicanja
 P1- pectin 71 % SE (esterification stage); P2- pectin 62 % SE (esterification stage);
 D-shear rate; T_k -temperature after fast increasement of shear stress and lower temperature
 decreaseament; T_m -the lowest sub-cooling temperature at which still shear occurs

Zaključak

Rezultati mjerenja reoloških svojstava ispitivanih kaša jabuke pri temperaturi 5 °C i 0 °C pokazuju da se svi uzorci ponašaju kao nenevtonske, pseudoplastične tekućine. Dodatkom ispitivanih pektina u osnovnu kašu jabuke u koncentraciji 0,2 % i 0,4 % pri ispitivanim niskim temperaturama 5 °C i 0 °C prividna viskoznost i koeficijent konzistencije se smanjuju a indeks tečenja povećava u odnosu na osnovnu kašu jabuke. Povećanjem udjela dodanih pektina s 0,2 % na 0,4 % pri ispitivanim temperaturama prividna viskoznost se povećava, dok pektini sa 71 % SE i 62 % SE imaju različit utjecaj na koeficijent konzistencije i indeks tečenja. Pri kontinuiranom hlađenju ispitivanih kaša od 0 °C do temperature na kojoj je još moguće smicanje (T_m) utvrđena je kritična temperatura T_k na kojoj dolazi do naglog povećanja smičnog naprezanja. Do temperature T_m kaše su imale viskozna svojstva, a na temperaturi T_m kaše imaju plastična svojstva. Kontinuiranim hlađenjem kaša jabuke od 0 °C do temperature T_m pri konstantnoj brzini smicanja smično naprezanje (τ) se povećava, ono je veće kod većeg udjela dodanog pektina i većeg stupnja esterifikacije pektina. Dodatkom pektina u kašu jabuke mijenjaju se reološka svojstva ispitivanih kaša kod niskih temperatura u području zamrzavanja. Uzrok tome je sniženje temperature zamrzavanja kod koje dolazi do nukleacije i nastajanja kristala leda što značajno utječe na reološka svojstva materijala u toj fazi procesa zamrzavanja. Dodatak pektina u kašu jabuke, udio i stupanj esterifikacije dodanog pektina različito utječu na temperature T_k i T_m . Sposobnost pektina kao sastojka koji utječe na očuvanje konzistencije kaše jabuke otvara mogućnosti primjene istog u razvoju novih proizvoda ili pak poboljšavanju postojećih proizvoda s ciljem unapređivanja kvalitete.

Literatura

- Ahmed J., Shivare V.S., Singh P. (2004): Colour kinetics and rheology of coriander leaf puree and storage characteristics of the paste, *Food Chem.* 84, 605-611.
- Branco I.G., Gasparetto C. (2003): A response surface methodology applied to the study of temperature effect on the rheological behavior of ternaries mixtures with mango pulp and orange and carrot juices, *Cienc. Tecnol. Aliment.* 23, 166-171.
- Cantu-Lozano D., Rao M.A., Gasparetto C.A. (2000): Rheological properties of noncohesive apple dispersion with helical and vane impellers: effect of concentration and particle size, *J. Food Process Eng.* 23, 373-385.
- Haminiuk C.W.I., Sierakowski M.R., Vidal J.R.M.B., Masson M.L. (2006): Influence of temperature on the rheological behavior of whole araca pulp (*Psidium cattleianum* sabine), *Food Sci. Technol. - LEB* 39, 426-430.
- Hegedušić V., Lovrić T. (1990): Utjecaj smrzavanja i temperature skladištenja na reološka svojstva kašastih proizvoda od jabuke, *Kem. Ind.* 39(8), 377-381.
- Hegedušić V., Herceg Z., Rimac S. (2000): Rheological properties of carboxymethylcellulose and whey model solutions before and after freezing, *Food Technol. Biotech.* 38(1), 19-26.
- Holdsworth S.D. (1971): Applicability of rheological models to the interpretation of flow and processing behavior of food products, *J. Texture Stud.* 2(4), 393-418.

- Ilicali D.R.C. (1985): Correlation for the consistency coefficients of apricot and pear purees, *J. Food Eng.* 8, 47-51.
- Oakenfull D.G. (1991): The chemistry of high-methoxy pectins. In: The chemistry and technology of pectin, Walter R.H. (ed.), New York, Academic press, pp. 87-108.
- Ohnishi S., Shimiyama Y., Kumagai H., Miyawaki O. (2004): Effect of freezing on electrical and rheological properties of food materials, *Food Sci. Technol. Res.* 10(4), 453-459.
- Pozderović A., Moslavac T., Pichler A. (2005): Utjecaj udjela suhe tvari na reološka svojstva kaše jabuke pri niskim temperaturama prije i tijekom smrzavanja, *Kem. Ind.* 54 (7-8), 341-346.
- Qui C-G, Rao M.A. (1988): Role of pulp content and particle size in yield stress of apple sauce, *J. Food Sci.* 53, 1165-1170.
- Rao M.A. (1977): Rheology of liquid foods – A review, *J. Texture Stud.* 8(2), 135-168.
- Rolin C. (1993): Pectin. In: Industrial gums: Polysaccharides and their derivatives, Whistler R. L., Bemiller J. N. (ed.), New York, Academic press, pp. 257-293
- Valera P., Salvador A., Fiszman S. (2007): Changes in apple tissue with storage time: Rheological, textural and microstructural analysis, *J. Food Eng.* 78, 622-629.
- Vitali A.A., Rao M.A. (1984): Flow properties of low-pulp concentrated orange juice: Effect of temperature and concentration, *J. Food Sci.* 49, 882-888.

Influence of pectin addition on rheological properties of apple puree at low temperatures

A. Pozderović, T. Moslavac, A. Pichler, K. Paragović

University of Josip Juraj Strossmayer in Osijek, Faculty of Food Technology Osijek, Franje Kuhača 20, 31000 Osijek, Croatia

Summary

Rheological properties of food are important for determining process parameters and defining sensory characteristics of certain food products. Apple puree is heterogenic colloid system that was made by pasting of mashed and thermal treated fruit. This paper deals with the influence of pectin content and esterification stage, shear and cooling rate on rheological properties of apple puree at low temperatures before and during freezing. Basic apple puree of Idared sort was made by blanching in 10 % sucrose solution and was used for preparation of purees with different puree combinations with addition of pectin (0.2 % and 0.4 %) with different esterification stage (71 % and 62 %). Rheological properties were measured by rotational viscosimeter with refrigeration unit. Dependence of shear rate and shear stress at 5 °C and 0 °C; at constant shear rate by continuous cooling were measured. The lowest sub-cooling temperature at which still shear occurs (T_m) and the temperature after fast increase of shear stress, apparent viscosity and lower temperature decrease (T_k) were determined. It was proved that all apple purees are non newtonian pseudoplastic. Apparent viscosity and consistency coefficient were enhanced with the increasing content of higher stage esterification pectin while the lower esterification pectin had the opposite effect. The addition of pectin decreased the freezing temperature.

Keywords: rheological properties, apple puree, low temperature, pectin

Electrical conductivity and ash content of selected honey types

UDC: 638.162 : 543.5

Lj. Primorac*, I. Flanjak, M. Cvijetić, Z. Đapić

*University of Josip Juraj Strossmayer in Osijek, Faculty of Food Technology Osijek,
Franje Kuhača 20, 31000 Osijek, Croatia*

Summary

Mineral content of honey can be evaluated through ash content and/or electrical conductivity measurement. It primarily depends on botanical origin but also on soil type where nectar-bearing plant was located. Electrical conductivity, ash content and free acidity of 6 selected honey types, black locust (*Robinia pseudoacacia* L.), chestnut (*Castanea sativa* Mill.), sage (*Salvia officinalis* L.), Christ's thorn (*Paliurus spina Christi* Mill.), bastard indigo (*Amorpha fruticosa* L.) and honeydew honey were determined, as well as the relationship between those physicochemical parameters. Black locust and bastard indigo honeys, lightest among determined honey types, had lowest ash content and electrical conductivity, while darker chestnut and honeydew honeys had highest values for ash content and electrical conductivity. Good relationship between electrical conductivity and free acidity was obtained ($r=0.504$), while relationship between electrical conductivity and ash content was very high ($r=0.980$).

Keywords: honey, electrical conductivity, ash content

Introduction

Honey consist mostly of carbohydrates, but minor constituents, like acids, minerals, flavonoids and enzymes are largely responsible for the differences among individual honey types. Some physicochemical parameters (electrical conductivity, carbohydrate content, enzymes, pH and acidity) in combination with pollen analysis are suggested for unifloral honey characterisation (Anklam, 1998; Persano Oddo et al., 1995).

Mineral content (ash) and composition primarily depends on botanical origin, but also on soil type where nectar-bearing plant was located. Nectar honey generally has lower ash content than honeydew honey. At present, time consuming and difficult measurement of ash content has been replaced by fast and simple electrical conductivity measurement. Electrical conductivity depends on mineral and acid content in honey, the higher their content, the higher the resulting conductivity (Bogdanov et al., 2000). Linear relationship between ash content and electrical conductivity is well documented (Silva et al., 2009; Kropf

*ljiljana.primorac@ptfos.hr

et al., 2008; Bogdanov et al., 2000; Sanz et al., 1994; Sancho et al., 1991) but the resulting linear regression models reported by some authors differ considerably. The aim of this work was to determine electrical conductivity, ash content and free acidity of 6 honey types, black locust (*Robinia pseudoacacia* L.), chestnut (*Castanea sativa* Mill.), sage (*Salvia officinalis* L.), Christ's thorn (*Paliurus spina Christi* Mill.), bastard indigo (*Amorpha fruticosa* L.) and honeydew honey, as well as to evaluate relationship between those quality parameters.

Materials and Methods

Honey samples

Honey samples were collected during several production seasons directly from the beekeepers from different regions of Croatia. Samples were subjected to pollen analysis with the aim of confirming honey type (Louveaux et al., 1978; Ministry of Agriculture and Forestry, 2000). Identification of present pollen grains was made by reference to the literature data (Von der Ohe and Von der Ohe, 2003) and/or personal comparative preparation.

From 108 analysed samples, 41 were black locust (*R. pseudoacacia* L.), 25 chestnut (*C. sativa* Mill.), 12 sage (*S. officinalis* L.), 10 Christ's thorn (*P. spina Christi* Mill.), 6 bastard indigo (*A. fruticosa* L.) and 14 honeydew honey.

Physicochemical parameters

Determined physicochemical parameters were analysed by the officially prescribed methods (Bogdanov et al., 2009; AOAC Official Methods, 2002).

Electrical conductivity was determined in 20 % (w/v) water solution of honey (dry matter basis) at 20 °C. The measurements were performed by means of the conductometer and the results were expressed in mS/cm.

Ash content of honey was determined by burning in electric furnace at 600 °C until constant mass was attained and the results were expressed as percentage by weight.

Free acidity was determined by titrimetric method and the results were expressed in mmol/kg honey.

Data analysis

For each determined physicochemical parameter ranges were given and average values and standard deviation calculated. Relationship between parameters was evaluated using the Pearson correlation coefficient. Data analysis was performed using Microsoft Excel 2003 (*Microsoft Corp.*).

Results and Discussion

Mineral content of honey can be evaluated through ash content and/or electrical conductivity measurement. Average values, standard deviations and ranges of

electrical conductivity, ash content and free acidity of 6 selected honey types are presented in Table 1.

Table 1. Electrical conductivity, ash content and free acidity of analysed honey types

Honey type	Electrical conductivity [mS/cm]			Ash content [%]			Free acidity [mmol/kg]		
	average	SD	min-max	average	SD	min-max	average	SD	min-max
Black locust (n=41)	0.11	0.02	0.09-0.17	0.04	0.01	0.02-0.06	7.5	0.9	5.7-9.7
Chestnut (n=25)	1.27	0.23	0.95-1.66	0.52	0.12	0.34-0.83	14.8	4.9	8.0-25.4
Sage (n=12)	0.24	0.05	0.19-0.33	0.08	0.03	0.06-0.13	17.1	3.4	11.6-25.9
Christ's thorn (n=10)	0.67	0.11	0.56-0.85	0.22	0.04	0.15-0.27	19.6	4.4	13.5-27.7
Bastard indigo (n=6)	0.16	0.03	0.12-0.21	0.02	0.02	0.01-0.05	14.4	1.7	11.9-16.0
Honeydew (n=14)	1.21	0.25	0.93-1.75	0.55	0.15	0.34-0.85	35	13.1	18.2-60.0

Regarding electrical conductivity all 108 samples were in compliance with national (Ministry of Agriculture, Fisheries and Rural Development, 2009) and international (Council of the European Union, 2002) demands, while 3 honeydew honey samples had free acidity above prescribed 50 mmol/kg.

Bastard indigo and black locust honeys had lowest ash content, 0.02 % and 0.04 % respectively, while chestnut (0.52 %) and honeydew honey (0.55 %) had highest ash content. In accordance with results for ash content, same honey types had lowest and highest values of electrical conductivity. Although chestnut honey is nectar honey, it is characterised by very high ash content and electrical conductivity which can be used as differentiation parameter between chestnut and other nectar honeys. Generally, darker honeys have higher ash content and electrical conductivity than lighter honeys.

Ash content and electrical conductivity of black locust and chestnut honey obtained in this work are lower than reported Kropf et al. (2008) for Slovenian and Persano Oddo et al. (1995) for Italian black locust and chestnut honey. Honeydew honey is characterised with high electrical conductivity and ash content, and the results obtained in this work are similar to the results for Czech (Čelechovska and Vorlova, 2001) and Slovenian honeydew honeys (Kropf et al., 2008), while Persano Oddo et al. (1995) reported higher electrical conductivity of honeydew honey. Christ's thorn honey, characteristic for Mediterranean part of Croatia, had higher ash content and electrical conductivity than other Mediterranean honeys like sage, rosemary and lavender. The results for electrical conductivity of Christ's

thorn and sage honey are similar to the results reported in our previous papers (Kenjeric et al., 2006; Kenjeric et al., 2008). Although bastard indigo honey can be compared to black locust regarding electrical conductivity, it has slightly lower ash content and much higher free acidity than black locust honey. Honey acidity depends largely on type of honey but also can give information on fermentation process, storage conditions and processing of honey. Some types of honey have naturally higher acidity without signs of fermentation (Sanz et al, 1994). Usually spring honeys have lower acidity than summer honeys.

Electrical conductivity is ability of sample to conduct electricity. In honey it depends on minerals/ash and acids present. Good relationship between electrical conductivity and free acidity was obtained ($r=0.504$), while relationship between electrical conductivity and ash content was very high ($r=0.980$) (Fig. 1 and 2).

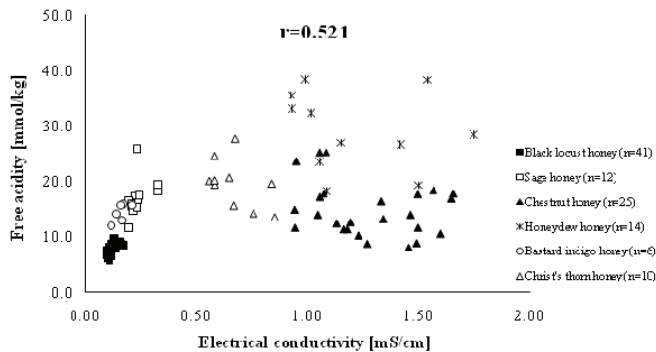

Fig. 1. Relationship between electrical conductivity [mS/cm] and free acidity [mmol/kg] of analysed honey types

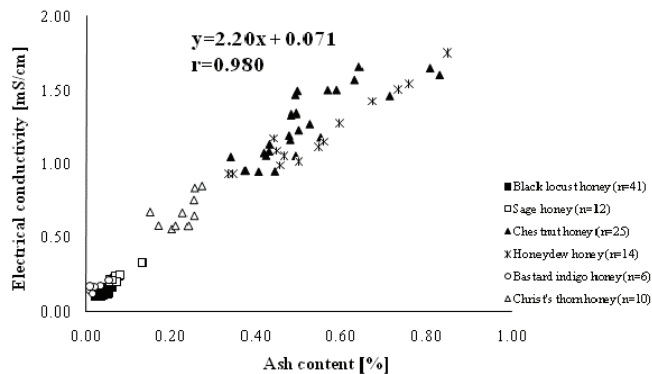

Fig. 2. Relationship between electrical conductivity [mS/cm] and ash content [%] of analysed honey types

Chestnut honey, naturally has very high electrical conductivity and low free acidity, contributes to weaker relationship between electrical conductivity and free acidity. When excluded all chestnut honey samples, the relationship between electrical conductivity and free acidity becomes more significant ($r=0.808$).

Linear regression model ($y=2.20x+0.071$, where y is electrical conductivity [mS/cm] and x is ash content [%]) for relationship between electrical conductivity and ash content obtained in this work differs from one proposed by International Honey Commission (IHC) (Bogdanov et al., 2000). The difference also exists between our linear regression model and one reported by Kropf et al. (2008) for Slovenian honeys. Possible explanation of difference could be in different honey types selected and their geographical origin, which results in different electrical conductivity values, as well as different number of samples used for calculation of linear regression model. Due to the difficulties that arise when comparing results calculated with different models, a model prescribed by IHC should be used as often as possible.

Conclusions

In six unifloral Croatian honey types electrical conductivity, ash content, and free acidity were evaluated and ranges for each parameter were given. The lowest ash content and electrical conductivity had lighter honeys, black locust and bastard indigo, while dark chestnut and honeydew honeys had highest values of determined physicochemical parameters. Although bastard indigo and black locust honey are comparable regarding electrical conductivity, the difference between those honey types was noticed in free acidity, which is almost two times higher for bastard indigo than black locust honey. Very high relationship was obtained between electrical conductivity and ash content, while relationship between electrical conductivity and free acidity was weaker, due to low free acidity of chestnut honey.

References

- Anklam, E. (1998): A review of analytical methods to determine the geographical and botanical origin of honey, *Food Chemistry* 61 (4), 549-562.
- AOAC International (2002): Official methods of analysis, Gaithersburg, Maryland, USA, (17th ed. rev. 1), Chapter 44, pp. 22-33.
- Bogdanov, S., Lülmann, C., Martin, P., Von der Ohe, W., Russmann, H., Vorwohl, G., Persano Oddo, L., Sabatini, A.-G., Marcazzan, G.L., Piro, R., Flamini, C., Morlot, M., Lheretier, J., Borneck, R., Marioleas, P., Tsigouri, A., Kerkvliet, J., Ortiz, A., Ivanov, T., D'Arcy, B., Mossel, B., Vit, P. (2000): Honey quality, methods of analysis and international regulatory standards. Review of the work of the International Honey Commission, Swiss Bee Res. Centre, 1-15.

Topic: Food technology and biotechnology

- Bogdanov S. (2009): Harmonised methods of the International Honey Commission, International Honey Commission (IHC), 1-61.
- Council of the European Union (2002): Council Directive 2001/110/EC of 20 December 2001 relating to honey, *Off. J. Eur. Commun.* L10, 47-52.
- Čelechovská, O., Vorlová, L. (2001): Groups of honey – physicochemical properties and heavy metals, *Acta Vet. Brno* 70, 91-95.
- Kenjeric, D., Primorac, Lj., Mandić, M.L., Bubalo, D., Perl Pirički, A., Flanjak, I. (2006): Dalmatian sage (*Salvia officinalis* L.) honey characterisation, *Deutsche Lebensmittel-Rundschau* 102, 479-484.
- Kenjeric, D., Primorac, Lj., Bubalo, D., Čačić, F., Corn, I. (2008): Palynological and physicochemical characterisation of Croatian honeys-Christ's thorn (*Paliurus spina Christi* Mill.) honey, *J. Cent. Eur. Agric.* 9(4), 689-696.
- Kropf, U., Jamnik, M., Bertoneclj, J., Golob, T. (2008): Linear regression model of the ash mass fraction and electricaj conductivity for Slovenian honey, *Food Technol. Biotechnol.* 46 (3), 335-340.
- Louveaux J., Maurizio A., Vorwohl G. (1978): Methods of melissopalynology, *Bee World* 59, 139-157.
- Ministry of Agriculture and Forestry (2000): Regulation on the quality of honey and other bee products, *Official Gazette* 20, 642-652.
- Ministry of Agriculture, Fisheries and Rural Development (2009): Regulation on the quality of honey, *Official Gazette* 93, 7-8.
- Persano Oddo, L. Sabatini, A., Piazza, M., Accorti, M. (1995): Characterization of unifloral honeys, *Apidologie* 26 (6), 453 - 465.
- Sancho M. T., Muniategui, S., Sánchez, M. P., Huidobro, J. F., Simal-Lozano, J. (1991): Relationships between electrical conductivity and total and sulphated ash contents in Basque honeys, *Apidologie* 22, 487-494.
- Sanz S., Pérez C., Herrera A., Sanz M., Juan T. (1994): La Rioja honey composition, *Rev.Esp.Cienc.Technol.Aliment.* 34(5), 540-552.
- Silva L.R., Videira R., Monteiro A.P., Valentão P., Andrade P.B. (2009): Honey from Luso region (Portugal): Physicochemical characteristics and mineral contents, *Microchem J.* 93, 73-77.
- Von der Ohe K., Von der Ohe W. (2003): Celle's Mellisopalynological Collection, Cielte, Germany: Niedersächsisches Landesinstitut für Bienenkunde.

Texture profile analysis of artisanal Croatian ewe's hard cheeses

UDC: 637.354 (497.5)

V. Slačanac^{*}, J. Hardi, V. Krstanović, Ž. Marketanović

*University of Josip Juraj Strossmayer in Osijek Faculty of Food Technology Osijek,
Franje Kuhača 20, 31000 Osijek, Croatia*

Summary

The aim of this study was to analyze texture of artisanal Croatian hard cheeses, produced according to long-lasting tradition, originally from some Adriatic islands, such as Pag and Krk. Except texture profile analysis (TPA), composition and some physico-chemical properties of analyzed cheeses (water activity, pH values, colour of cheeses) were determined. Obtained results show that wide range of variability between analyzed hard ewe's cheeses exists. Cheeses were differing in following textural parameters: hardness, cohesiveness, springiness, elasticity and chewiness. Furthermore, parameters of colour, analyzed on the base of colour measurements parameters (L^* , a^* , b^*) varied between analyzed cheeses. It has been indicate that yellow nouance of island cheeses dominate in relation to continent cheeses. Differences pH values were also statistically significant between cheeses, whereas the water activity (a_w) between analyzed cheeses was not significantly different.

Keywords: artisanal ewe' hard cheeses, texture profile, colour, water activity, pH value

Introduction

Every dairy food has a "texture" that defines the product type and level of quality (Foegeding et al., 2003). Cheese is one dairy food where texture is a critical factor in evaluation of quality (Marshall, 1990; Drake et al., 1999). In a number of studies has been confirmed that texture and flavour affect consumer perception of quality and acceptability (Wilkinson et al., 2000). Instrumental TPA (Texture Profile Analysis) has been used to "profile" or "fingerprint" cheese (Drake et al., 1999). In a number of studies has been observed that instrumental TPA good correlating with sensory texture attributes (Rephaelides et al., 1995; Foegeding et al., 2003). In this study, texture profiles and physicochemical characteristics (composition, acidity, colour and water activity) of 6 autochthonous Croatian hard ewe's cheeses, originally from Croatian Mediterranean were analyzed. Additionally, physicochemical and texture properties of analyzed Croatian artisanal cheeses were compared with these of Italian and Spanish hard ewe's cheeses.

^{*}Vedran.Slacanac@ptfos.hr

Materials and Methods

6 types of hard ewe's Croatian cheeses, as well as 1 type of Italian and 1 type of Spanish hard cheese were analyzed. Cheeses were coded as:

- A1, A2, A3, A4, A6 and A6 – for analyzed Croatian cheeses
- B1 – for an Italian type of hard ewe's cheese
- C1 – for a Spanish type of hard ewe's cheese

Cheese composition was analyzed using a FoodScan Analyzer (Foss, Sweden), according to the method described in Lawrence et al. (1987), which has been usually used for composition analyze of semi-hard and hard cheeses. Water, protein, milk fat and NaCl content were analyzed in all cheese samples.

pH values of analyzed ewe's cheeses were measured by MA 235, pH/Ion Analyzer (METTLER TOLEDO; Germany), according to official AOAC 962.19 method.

Water activity in cheeses was conducted by Rotronic Hygrolab 3 (Rotronic AG, Bassersdorf, Switzerland).

Measurement of colour was performed on Hunter-Lab Mini ScanXE (A60-1010-615 Model colorimeter, hunter-Lab, Reston, VA, USA). Hunter's parameters for the colour definition have been explained as:

- a* - green (-a*) or red (+a*)
- b* - blue (-b*) or yellow (+b)
- L* - totally bright (L* = 100) or totally dark (L* = 0).

Texture profile analyzes were conducted on TA.XT2i Plus (SMS Stable Micro Systems Texture Analyzer, Surrey, England) For instrumental TPA cheeses were cut into 15 mm cubes and warmed to room temperature. The test conditions were optimized as the follows (Bourne and Comstock, 1981): TA-25 probe; 50 mm dia cylinder; test speed 0.4 mm/s; pretest and posttest speed 0.4 mm/s; compression 80 %; pause 5 s. Following textural parameters were measure: hardness, cohesiveness, gumminess, resilience (deferred elasticity) and chewiness.

Puncture test was conducted using a TT-43 (PA/20) needle; dia 0.64 cm. Test and pretest speed were 0.5 mm/s, whereas the altitude of puncture throughout the cheese was 20 mm. Two parameters were determined by the puncture test: bioyield (kg/s) and flesh firmness (kg/s).

All the results were statistically analyzed by the use of Descriptive statistics pack in STATISTICA 8.0. Parameter values were compared between different samples using Correlation matrices and Fisher's Least Significance Differences (LSD) test, also in STATISTICA 8.0.

Results and Discussion

The basic composition and salt content in analyzed cheeses was presented in Table 1.

Table 1. Water, protein, milk fat and NaCl content in samples of hard ewe's (% , g/100 g)

Sample	Water*	Milk fat*	Proteins*	NaCl*
A1	37.58±1.2	32.01±0.05	42.08±0.5	1.80±0.2
A2	36.01±2.5	31.98±1.35	45.76±0.7	2.75±0.2
A3	38.26±0.7	31.14±0.11	47.89±1.2	1.65±0.4
A4	31.15±1.3	32.56±0.49	47.70±0.8	1.75±0.2
A5	38.27±1.1	28.66±2.26	40.32±1.4	2.81±0.7
A6	33.21±3.6	30.80±0.75	47.30±1.8	1.56±0.3
B1	33.55±1.8	33.50±2.66	41.41±0.6	2.12±0.5
C1	37.53±0.7	28.21±1.05	42.25±0.5	1.61±0.1

* - mean value ± SD of 5 replications

A1, A2, A3, A4, A5, A6, B1, B2 – coded cheeses

It is obvious that some significant differences between cheeses exist, both in composition and salt content. It could be the result of many factors during production and maturation of cheese, such as ovine milk composition, milk fermentation, traditional technological procedure and ripening duration. All analyzed cheeses are strictly traditional, and procedures of their production have regional character. E. g., cheeses produced on Croatian Mediterranean islands have been characterized with use of sea salt and lower salinity than cheeses produced in Croatian inland (Mioč et al., 2007).

In spite of determined differences in composition, pH values and water activity (a_w) between analyzed cheeses were not statistically significant (Table 2).

Table 2. Water activity (a_w) i pH values of analyzed cheeses *

Sample	a_w	pH
A1	0.906±0.06	5.40±0.05
A2	0.895±0.11	5.45±0.2
A3	0.903±0.10	5.55±0.05
A4	0.858±0.08	5.60±0.13
A5	0.931±0.08	5.60±0.09
A6	0.908±0.06	5.55±0.15
B1	0.915±0.07	5.65±0.15
C1	0.898±0.12	5.50±0.10

* - mean value ± SD of 5 replications

A1, A2, A3, A4, A5, A6, B1, B2 – coded cheeses

It suggests similar duration of ripening processes, as well as similar ways of milk fermentation during cheese production.

Very important parameter which has sensory and psychological influence on customers is colour of cheese. The results of the colour analyses are presented in Table 3. Variations in values of all three Hunter's parameters between cheeses are obvious. However, all analyzed cheeses had clearly expressed yellow nuance and high level of brightness, what has been characteristically for ovine cheeses, especially for hard ovine cheeses which mature during long time (Ryffel et al., 2008). Take to be mentioned that to cheeses analyzed in this study was not added colour, than it is arise from differences in milk composition and ripening processes.

Table 3. Measured values of colour parameters (*, **)

Sample	<i>L</i> *	<i>a</i> *	<i>b</i> *
A1	78.14 ^b	-0.48 ^c	20.75 ^d
A2	77.93 ^b	-1.51 ^c	24.86 ^{bc}
A3	77.25 ^b	-1.25 ^d	25.52 ^{ab}
A4	81.86 ^a	4.38 ^a	26.04 ^a
A5	75.65 ^c	-2.37 ^b	18.71 ^e
A6	72.96 ^d	-1.57 ^c	20.21 ^{de}
B1	74.29 ^{cd}	-1.63 ^c	24.65 ^{bc}
C1	78.72 ^b	2.22 ^b	25.50 ^{ab}

A1, A2, A3, A4, A5, A6, B1, B2 –coded cheeses

*L** (0= dark; 100 = total bright), *a** (+ red, - green), *b** (+ yellow, - blue)

*Mean values followed by the same letter in the same column not significantly different (P<0.05)

**Mean ± standard deviation, n = 5

Table 4 shows the values of textural parameters measured by TPA. According to the measured values, all cheeses have hardness typical for long-time ripened ewe's hard cheeses (Medina and Nunez, 2004). However, some variability between cheeses texture was still determined. The largest differences between cheeses were noted for hardness and chewiness. Cohesiveness was approximately equable for all analyzed cheeses, whereas the guminess and resilience varied between different cheeses, but not obviously like hardness and chewiness.

Correlation between some TPA parameters, e.g. between hardness and chewiness had been expected. However, calculated correlation parameters (Table 5) show that only statistically significant correlation was between cohesiveness and gummines.

Table 4. The Texture Profile Analysis results (*, **)

Sample	Hardness*	Cohesiviness**	Gumminess**	Resilience**	Chewiness**
A1	13204.073 ^{bc}	0.587	0.08	0.566	974.979 ^b
A2	12683.214 ^c	0.584	0.08	0.472	360.061 ^{dc}
A3	14302.093 ^d	0.531	0.053	0.610	607.625 ^c
A4	13693.157 ^b	0.556	0.059	0.560	553.192 ^{cd}
A5	12582.805 ^{cd}	0.572	0.074	0.596	416.793 ^d
A6	12796.97 ^c	0.598	0.061	0.692	312.350 ^e
B1	13434.779 ^b	0.590	0.042	0.460	299.839 ^e
C1	14517.460 ^d	0.606	0.071	0.874	1207.804 ^a

A1, A2, A3, A4, A5, A6, B1, B2 – coded cheeses

*Mean values followed by the same letter in the same column not significantly different (P<0.05)

** Mean ± standard deviation, n = 10

Table 5. Correlation matrix for TPA parameters

	Hardness	Cohesiviness	Gumminess	Resilience	Chewiness
Hardness	1.00	0.12	-0.36	0.51	0.64
Cohesiviness	0.12	1.00	0.83	0.32	0.69
Gumminess	-0.36	0.83	1.00	0.17	0.39
Resilience	0.51	0.32	0.17	1.00	0.66
Chewiness	0.64	0.69	0.39	0.66	1.00

Statistically significant on p ≤ 0.05

Picture test could be good indicator of crust thickness, crust hardness, but also of cheese hardness from crust to the center of cheese. Crust properties have been determined by flesh firmness, while the cheese hardness has been detected on the base of bioyield values. Table 6 show values measured by puncture test. The highest bioyield values were measured for Spanish and Italian hard ewe's cheese, but also for one Croatian cheese (coded as A1).

Table 6. The puncture test results for analyzed hard ewe' cheeses (*, **)

Sample	Bioyield (kg/s)	Flesh firmness (kg/s)
A1	420.068 ^d	161.494 ^c
A2	237.011 ^c	97.369 ^e
A3	320.389 ^b	211.706 ^a
A4	323.467 ^b	180.646 ^b
A5	156.786 ^d	96.578 ^e
A6	199.948 ^{cd}	141.311 ^d
B1	420.068 ^d	186.453 ^{ab}
C1	425.408 ^d	156.453 ^c

A1, A2, A3, A4, A5, A6, B1, B2 – coded cheeses

*Mean values followed by the same letter in the same column not significantly different (P<0.05)

**Mean ± standard deviation, n = 10

Wide range of variations between bioyield values of analyzed cheeses was noted (Lavanchy et al, 1994). It can be said that cheeses with high bioyield values has high hardness deep in the field of cheese. Differently, in cheeses with lower bioyield values, hardness decrease from crust to the cheese center. Flesh firmness is not in correlation with the bioyield and indicates the force necessary for breakthrough of cheese crust. According to data presented in Table 6, cheese A3 had the highest crust thickness and hardness. Statistical analyze of experimental data show that bioyield values obtained by puncture test are in correlation with values for hardness ($r = 0.78$) and chewiness ($r = 0.69$) given by TPA.

Conclusions

Results obtained by this study show that for the definition of cheese texture complex analyze is necessary and many factors must be taken into consideration. Cheese quality is directly defined with the parameters such as composition, texture, colour and acidity. Between them cheese texture is the most hardly to describe. Both TPA and puncture analysis could give adequate number of information for describing of cheese texture. Some variations in textural and physicochemical parameters between analyzed cheeses were noted, but all cheeses had characteristics typical for hard ewe's cheeses.

References

- Bourne, M., Comstock, S. H. (1981): Effect of degree of compression on texture profile parameters. *J. Texture Studies* 12, 201-216.
- Drake, M. A., Gerard, P. D., Truong, V. D., Daubert, C. A. (1999): Relationship between instrumental and sensory measurements of cheese texture. *J. Texture Studies* 30, 451-476.
- Foegeding, E. A., Brown, J., Drake, M-A., Daubert, C. R. (2003): Sensory and mechanical aspects of cheese texture. *Int. Dairy J.* 13, 585-591.
- Lavanchy, P., Berodier, F., Zannoni, M., Noel, Y., Adamo, C., Squella, J., Herrero, L. (1994): A guide to the sensory evaluation of texture of hard and semi-hard cheeses. *INRA Editions*, pp. 24-31.
- Lawrence, R. C., Gilles, J., Creamer, L. K. (1987): Symposium: Cheese ripening technology. *J. Dairy Sci.* 70, 1748-1760.
- Marshall, R. J. (1990): Composition, structure, rheological properties and sensory texture of processed cheese analogues. *J. Sci. Food Agricult.* 50, 237-252.
- Medina, M. and Nunez, M. (2004): cheeses made from ewe's and goat's milk. In: Fox F. P. (Ed.), *Cheese: Chemistry, Physics and Microbiology*. Vol. 2: Major Cheese Grops, third ed. Elsevier, Accadmic Press, London, pp. 279-299.
- Mioč, B., Pavić, V., Sušić, V. (2007): *Ovčarstvo (Sheep-farming)*, Hrvatska mljekarska udruga (Croatian Dairy Union), Zagreb, Croatia.
- Raphaelides, S., Antoniou, K. D., Petridis, D. (1995): Texture evaluation of ultrafiltered Teleme cheese. *J. Food Sci.* 60, 1211-1215.
- Ryffel, S., Piccinali, P., Butikofer, U. (2008): Sensory descriptive analysis and consumer acceptability of selected Swiss goat and sheep cheeses. *Small Rumin. Res.* 79, 80-86.
- Wilkinson, C., Dijksterhuis, G. B., Minekaus, M. (2000): From food structure to texture. *Trends Food Sci. Technol.* 11, 442-450.

Utjecaj mlijeka u prahu i uvjeta čuvanja na stabilnost čokolada

UDC: 663.915

S. Škrabal^{1*}, D. Šubarić², B. Miličević¹, Đ. Ačkar²,
J. Babić², R. Miličević³

¹Zvečevo dd, Prehrambena industrija, Kralja Zvonimira 1, 34000 Požega, Hrvatska

²Sveučilište Josipa Jurja Strossmayera u Osijeku, Prehrambeno tehnološki fakultet
Osijek, Franje Kuhača 20, 31000 Osijek, Hrvatska

³Fakultet za zaštitu i sigurnost na radu, I. Lučića 5, 10000 Zagreb, Hrvatska

Sažetak

Sivljenje površine čokolade i proizvoda koji sadrže čokoladu predstavlja jedan od najvećih problema konditorske industrije, koji rezultira promjenom senzorskih svojstava i teksture proizvoda. Do navedene pojave mogu dovesti brojni razlozi, a prije svega svojstva sastojaka, tehnološki parametri proizvodnje te uvjeti čuvanja. U ovome radu je ispitivan utjecaj različitih tipova mlijeka u prahu i uvjeta čuvanja na pojavu „sivljenja“ površine mliječne čokolade. U tu svrhu pripravljene su mliječne čokolade uz dodatak različitih tipova mlijeka u prahu. Nakon pripreme uzorci su tijekom 55 dana držani u sljedećim uvjetima: 12 sati pri 20 °C te potom 12 sati pri 29 °C i pri vlažnostima zraka ispod 50 %, 65 % i 75 %. Za praćenje sivljenja površine uzoraka korišten je tristimulusni kromametar, a pomoću diferencijalne motridbene kalorimetrije (DMK) praćena je promjena sastava površinskog sloja čokolade u cilju utvrđivanja mehanizma migracije masti na površinu. Rezultati istraživanja su pokazali da su tip mliječne sirovine i uvjeti čuvanja imali znakovit utjecaj na pojavu sivljenja površine čokolade. Navedeno je posebno evidentno pri višim vlažnostima zraka pri čemu je do izražaja došla higroskopnost sastojaka kao i pojava još jednog mehanizma sivljenja proizvoda. DMK mjerenjima sloja s površine proizvoda dobiveni su rezultati koji su pomogli u rasvjetljenju pojave sivljenja čokoladnih proizvoda.

Ključne riječi: mliječna čokolada, sivljenje, DMK, mlijeko u prahu

Uvod

Sivljenje površine čokolade je rezultat složenog procesa koji se odvija u čokoladi tijekom stajanja proizvoda ili kao posljedica loše vođenog tehnološkog procesa, korištenja neodgovarajućih sirovina te loših uvjeta skladištenja (Hamond i sur., 2006; Seguire, 2001). Sivljenje površine čokolade može se javiti kao posljedica migracije masti iz unutrašnjosti na površinu čokolade (tzv. masno sivljenje) ili kao posljedica stvaranja bijelog filma uslijed izdvajanja i kristalizacije šećera (tzv. šećerno sivljenje).

* svjetlana.skrabal@zvecevo.hr

DMK analize i promatranja pojave pod mikroskopom doveli su do zaključka da sivi dijelovi na površini odgovaraju kakaovom prahu i šećernim kristalima (Fryer i sur. 2000; Lonchampt i sur., 2006). Do navedene pojave može doći tijekom proizvodnog procesa ili tijekom skladištenja i transporta čokolade. Šećerno sivljenje ubrzava proces masnog sivljenja čokolade. Naime, uslijed *izlaska* šećera na površinu čokolade dolazi do oštećenja površine čokolade što uzrokuje ubrzanje migracije masti na površinu (Lonchampt i sur., 2006; Fryer i sur. 2000; Tietz i sur., 1998). *Masno sivljenje* čokolade je puno češće od šećernog. Sam mehanizam pojave nije još uvijek u potpunosti razjašnjen, ali pretpostavlja se da je to rezultat kombiniranog učinka polimorfne transformacije kakaovog maslaca (od oblika V do oblika VI) i razdvajanja faza (Hamond i sur., 2006; Seguire, 2001; Tietz i sur., 1998).

Upotrebom atomske mikroskopije (eng. *atomic force microscopy*) za istraživanje površine mliječne čokolade koja je bila izložena temperaturnim ciklusima 25 – 27 – 25 °C svaka 2 sata (u trajanju od 6, 12 i 24 ciklusa), utvrđeno je da je tek kod 24 – tog ciklusa došlo do prelaska β (V) oblika kakaovog maslaca u β (VI) oblik. Na površini su se pojavili mali kristali koji su imali sposobnost rasta (Rousseau, 2006). Sivljenje čokolade pospješuje i *razdvajanje faza* do kojeg dovode oscilacije temperatura tijekom skladištenja. Uslijed povišenja temperature pri kojoj se čuvaju čokoladni proizvodi, trigliceridi nižeg tališta prelaze u tekuće stanje, da bi hlađenjem ponovno iskristalizirali. Međutim, rastaljene masti rekristalizacijom se neće *povezati* s krutom fazom u kojoj se nalaze masti višeg tališta.

Raslojavanje pojedinih masnih frakcija u čokoladi često se pripisuje migraciji tekućih masnoća na površinu pomoću *kapilarne tranzicije* koja je potpomognuta razlikom u koncentraciji triacilglicerola (TAG) (Smith, 2007).

Proučavajući svojstva čokolade nakon dodavanja bezvodne mliječne masti i pet mliječnih frakcija dobivenih suhim frakcioniranjem mliječne masti, Tietz i sur. (2000) zaključili su da lipidi koji su u mliječnoj masti zastupljeni u manjim udjelima u velikoj mjeri utječu na vrijeme nukleacije, brzinu kristalizacije i brzinu *sivljenja* površine čokolade. Utjecaj mliječne masti ovisi o njenoj vrsti te o polarnim lipidima u mliječnoj masti. Utvrđeno je da je sivljenje mliječne čokolade u izravnoj vezi s udjelom slobodnih masnih kiselina, diacilglicerola i monoacilglicerola (Tietz i sur., 2000; Toro-Vazquez i sur., 2005; Rousseau, 2006; Ransom-Painter, 1997). Za sivljenje čokolade koje se javlja tijekom skladištenja karakterističan je rast malih kristala na površini i unutar proizvoda nakon određenog perioda (Hamond i sur. 2006; Timms, 2003). Uslijed oscilacija temperature tijekom skladištenja, bile one i vrlo male, u čokoladi dolazi do promjena na kristalima masti pri čemu nastaju novi polimorfni oblici. Kada temperatura poraste dovoljno visoko (iznad 32 °C), kakaov maslac se djelomično tali. Hlađenjem rastaljeni kakaov maslac nekontrolirano kristalizira u nestabilne polimorfne oblike zbog nedostatka jezgri stabilnih oblika, tako da i najmanje temperaturne oscilacije ubrzavaju pojavu sivljenja (Fong, 2004).

Za dužu stabilnost čokolada se treba skladištiti pri temperaturi od 15 do 18 °C i relativnoj vlažnosti zraka do 60 %. Pri višim temperaturama odvijaju se procesi polimornog prijelaza kakaovog maslaca i ubrzava se proces sivljenja.

Na adsorpciju vode u proizvod i šećerno sivljenje tijekom skladištenja utječu struktura čokolade i prisutnost hidrofilnih čestica koje vežu vodu. Imajući u vidu neke dosadašnje spoznaje o mogućnostima sprječavanja pojave šećernog sivljenja, može se konstatirati da ukoliko se proizvodi čuvaju pri relativnoj vlažnosti zraka do 60 %, do sivljenja neće doći tijekom 3 do 4 mjeseci pri temperaturi 17 °C, 5 do 6 mjeseci pri temperaturi 2 – 4 °C te više od 12 mjeseci pri temperaturi -18 °C (Timms, 2003).

Cilj ovoga istraživanja je bio utvrditi utjecaj tipa mlijeka u prahu na stabilnost prema sivljenju čokolada pri različitim uvjetima čuvanja (temperatura i vlažnost zraka) te utvrditi moguće mehanizme sivljenja čokolada analizom sive mase izlučene na površini proizvoda.

Materijal i metode

Priprema uzoraka

Čokolade su proizvedene standardnim postupkom proizvodnje čokoladnih masa u Tvornici konditorskih proizvoda „Zvečevo“, te upločene na automatskoj liniji Cavemil 600 (Carle and Montanari, Italija). U svrhu istraživanja priređeno je pet vrsta mliječne čokolade koje su se razlikovale prema porijeklu mliječne komponente. Svaki od uzoraka sadržavao je 50 % šećera, 30 % kakovog maslaca te 4,40 % mliječne masti. Uzorak MC-1 je sadržavao punomasno mlijeko u prahu proizvedeno sušenjem raspršivanjem (26 % mliječne masti, proizvođač Zvečevo, Požega, Hrvatska) i obrano mlijeko u prahu (1 % mliječne masti, proizvođač, Laktopol Sp.z.o.o. Warszawie, Poljska); uzorak MC-2 je sadržavao punomasno mlijeko u prahu proizvedeno sušenjem raspršivanjem (26 % mliječne masti, proizvođač, Laktopol Sp.z.o.o. Warszawie, Poljska) i obrano mlijeko u prahu (1 % mliječne masti, proizvođač, Laktopol Sp.z.o.o. Warszawie, Poljska); uzorak MC-3 je sadržavao punomasno mlijeko u prahu proizvedeno sušenjem na valjcima (26 % mliječne masti, proizvođač Zvečevo, Požega, Hrvatska) i obrano mlijeko u prahu (1 % mliječne masti, proizvođač, Laktopol Sp.z.o.o. Warszawie, Poljska); uzorak MC-4 je sadržavao karamelizirano punomasno mlijeko u prahu proizvedeno sušenjem na valjcima (26 % mliječne masti, proizvođač Zvečevo, Požega, Hrvatska) i obrano mlijeko u prahu (1 % mliječne masti, proizvođač, Laktopol Sp.z.o.o. Warszawie, Poljska); uzorak MC-5 je sadržavao karamelizirano punomasno mlijeko u prahu proizvedeno sušenjem na valjcima (26 % mliječne masti, proizvođač Hochdorf Swiss Milk AG, Hochdorf, Švicarska) i obrano mlijeko u prahu (1 % mliječne masti, proizvođač, Laktopol Sp.z.o.o. Warszawie, Poljska).

Tehnološki parametri pri upločavanju uzoraka

Temperatura čokoladne mase (prije izlijevanja u kalupe) je bila 30 - 30,5 °C; temperatura kalupa 29 °C; temperatura hladnjaka 5 °C; temperatura upločene čokolade 18 - 20 °C i temperatura radnog prostora za pakiranje čokolade 21 - 24 °C.

Čuvanje uzoraka

Proizvedene čokolade čuvane su otvorene tijekom 55 dana u rashladnom inkubatoru s kontrolom vlage (Climacell, Medical Intertrade) u kontroliranim uvjetima: 12 sati pri 20 °C te 12 sati pri 29 °C pri relativnoj vlažnosti ispod 50%; 12 sati pri 20 °C te 12 sati pri 29 °C pri relativnoj vlažnosti 65 %; 12 sati pri 20 °C te 12 sati pri 29 °C pri relativnoj vlažnosti 75 %.

Mjerenje boje gornje površine uzoraka provedeno je odmah po pripravi uzoraka te svakih 10 dana, a posljednje mjerenje obavljeno je 55. dan. Mjerenje boje čokolade provedeno je primjenom tristimulusnog kromametra Conica Minolta CR-600.

Mjerenje boje površine čokolade i obrada rezultata

Kromametar Conica Minolta CR-600 mjeri reflektiranu svjetlost s površine predmeta. Predmet se postavlja na otvor mjerne glave određenog promjera. U otvoru se nalazi ksenonska lučna svjetiljka koja pulsiranjem svjetlost baca okomito na površinu predmeta. Svjetlost se reflektira, a takvu svjetlost mjeri šest jako osjetljivih silikonskih fotoćelija. Podatke zapisuje računalo i izražava ih u pet različitih sustava (X, Y, Z; Yxy; Lab; Hunter Lab). Lab sustav daje približne vrijednosti kao i ljudsko oko te je stoga i korišten u ovome radu, a dobiveni parametri boje su L^* , a^* i b^* . L^* vrijednosti kreću se od 0 do 100 te daju ocjenu je li nešto tamno ili svijetlo. Ukoliko je $L^*=0$, predmet je crn, a ako je $L^*=100$, onda je bijel. a^* vrijednost može biti pozitivna ili negativna. Pozitivne vrijednosti ukazuju na crvenu, a negativne na zelenu boju. b^* vrijednost također može biti pozitivna ili negativna. Ako je vrijednost pozitivna, rezultat je žuta boja, a ako je negativna, plava (Bricknell i sur., 1998).

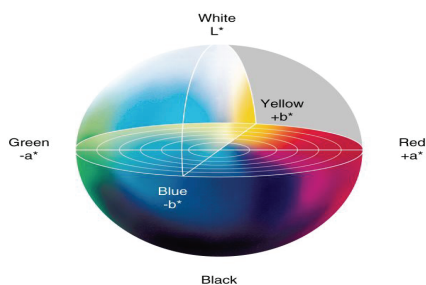

Slika 1. Prikaz očitavanja boje u Lab sustavu
Fig. 1. Display readings color in the Lab color system

Na osnovi izmjerenih vrijednosti (10 za svaki uzorak) izračunati su indeksi izbjeljivanja (WI) i vrijednost ukupne promjene boje (ΔE) prema slijedećim izrazima (Tietz i sur., 2000):

$$WI = 100 - [(100 - L^*)^2 + a^{*2} + b^{*2}]^{0,5}$$
$$\Delta E = [(\Delta L^*)^2 + (\Delta a^*)^2 + (\Delta b^*)^2]^{0,5}$$

Određivanje termofizikalnih svojstava

Za mjerenje termofizikalnih svojstava uzeti su uzorci čokolada nakon 55 dana čuvanja, a koji su prethodno korišteni za mjerenje promjene boje te uzorci čuvani pri sobnoj temperaturi („0^o uzorak“). S površine čokolade laganim struganjem je odstranjen površinski sloj koji je tijekom čuvanja promijenio boju. Upotrijebljene su odvage uzoraka 10 do 20 mg, a uzorci su vagani u standardnu aluminijsku posudu (40 μ L).

Posudica s uzorkom nakon vaganja hermetički je zatvorena, a zatim je provedeno mjerenje termofizikalnih svojstava.

Uzorci su bili podvrgnuti sljedećem temperaturnom programu: izotermno na 50 °C, 1 minuta; hlađenje od 50 °C do 0 °C, brzina hlađenja 10 °C/min.; izotermno na 0 °C, 1 minuta; zagrijavanje od 0 °C do 200 °C, brzina zagrijavanja 10 °C/min.

Korišten je kalorimetar Mettler-Toledo DSC model 822^e, a mjerenja su provedena u atmosferi dušika čistoće 5.0 (Linde). U radu je korištena totalna kalibracija n-oktan/In, dok je kalibracija toplinskog toka napravljena sa indijem (In), te opcija hlađenja sa tekućim dušikom (kontejner od 100 L, Messer, Frankfurt).

Obrada rezultata DMK mjerenja

DMK parametri: promjena entalpije (ΔH), temperatura početka procesa (T_o), temperatura vrha krivulje (T_p) i temperatura završetka (T_e) su dobiveni iz DMK egzotermne krivulje pomoću «STARe» softvera.

Rezultati i rasprava

Promjena boje površine proizvoda koji sadrže čokoladnu masu (čokolada, proizvodi presvučeni čokoladom, deserti, ...) jedan je od najvećih problema konditorske industrije (Aguilera i sur., 2004; Ghosh i sur. 2002; Briones i sur., 2005) pa se istraživanju ove pojave poklanja značajna pozornost. Iako je problem prisutan već dugo, još uvijek se istražuju mehanizmi te mogućnosti sprječavanja ove pojave. U ovome radu praćena je pojava sivljenja površine priređenih uzoraka čokolada, primjenom tristimulusnog kromametra, pri

sljedećim uvjetima čuvanja uzoraka: 12 sati pri 20 °C, zatim 12 sati pri 29 °C (svaki 10. dan tijekom 55 dana), pri tri različite vlažnosti zraka u prostoru u kojima su uzorci čuvani (50 %, 65 % i 75 %).

Na osnovi rezultata istraživanja može se konstatirati da su pojedine vrste mlijeka u prahu te vlažnost prostora u kojima su uzorci čuvani imali različit utjecaj na sivljenje površine ispitivanih čokolada. Pri tome su promjene kod pojedinih uzoraka, prije svega onih koji su čuvani u prostoru koji je sadržavao 75 % vlage u zraku, toliko uznepredovale da su pored pojave bijele prevlake na površini proizvoda dovele i do promjene teksture čokolade koja je u unutrašnjosti postala krta i „suha“.

Iz rezultata prikazanih u Tablici 1 vidljivo je da su uzorci mliječnih čokolada tijekom vremena čuvanja mijenjali boju. Čokolade koje su sadržavale mlijeko u prahu sušeno raspršivanjem intenzivno su posivile nakon 20 dana u prostoru sa 65 % vlage.

Iz nekih dosadašnjih istraživanja (Liang i sur., 2004; Momura i sur., 1988; Schmelzer i sur., 2001; Keogh i sur., 2004) može se zaključiti da mliječna mast djeluje kao inhibitor sivljenja. Navedena tvrdnja potvrđena je i u ovom istraživanju ako se u obzir uzmu uzorci MC-1 i MC-3, prije svega pri udjelu vlage u prostoru od 65 %. Uzorak MC-3 je sadržavao mlijeko u prahu sušeno na valjcima što kao posljedicu ima veći udio slobodne masti koja kao takva više utječe na pojedine parametre kvalitete, pa tako i na inhibiciju sivljenja. Kao posljedica toga, vrijednost ΔWI kod uzorka MC-3, nakon 55 dana i pri vlažnosti 65 % iznosila je 1,37 (Slika 4), a kod uzorka MC-1 (sadržavao mlijeko u prahu sušeno raspršivanjem) 2,81 (Slika 2). Pri vlažnosti zraka 75 % oba uzorka su se ponašala slično (intenzivno sivljenje je obuhvatilo cijelu površinu proizvoda). Navedena pojava je vjerojatno posljedica upijanja vode iz zraka koja se vezala za proteine i ugljikohidrate (šećere) te dovela do otapanja šećera i stvaranja putova za izlazak masti na površinu. Promjene koje su zapažene pri vlažnosti zraka 50 % kod oba uzorka su takvog intenziteta da ih prosječan konzument proizvoda ne bi okarakterizirao kao negativne, a nisu dovele ni do promjene drugih svojstava proizvoda. Uzorci mliječne čokolade MC-4 i MC-5 pripremljeni su korištenjem dva tipa (različiti proizvođači) karameliziranog mlijeka sušenog na valjcima. Iz rezultata prikazanih Slikama 5 i 6 vidljivo je da su značajnije promjene boje površine zamijećene kod uzorka MC-4 50-ti dan pri 75 % vlage, a kod uzorka MC-5 20-ti dan. Budući da je udio sastojaka identičan, razlika je vjerojatno posljedica različitih svojstava karameliziranoga mlijeka.

Tablica 1. Utjecaj vlažnosti zraka na ukupnu promjenu boje (ΔE) površine uzoraka mliječnih čokolada čuvanih u temperaturnom režimu 20 °C/12 h – 29 °C/12 h

Table 1. Influence of humidity on the overall color change (ΔE) surface samples of milk chocolate at temperature regime 20 °C/12 h - 29 °C/12 h

dan	ΔE , r.h. >50% r.h		MC-3	MC-4	MC-5
	MC-1	MC-2			
0					
10	0,76	1,29	1,10	1,02	1,05
20	1,65	1,96	2,00	1,80	2,42
30	1,23	1,48	1,66	1,62	1,79
40	1,17	2,03	2,26	2,27	2,24
50	1,36	1,82	1,89	1,65	1,55
55	1,56	2,05	2,23	2,13	2,00
	ΔE , r.h. 65% r.h		MC-3	MC-4	MC-5
dan	MC-1	MC-2			
0					
10	1,76	2,31	2,00	1,91	3,33
20	1,94	2,74	3,00	3,03	3,06
30	1,29	2,02	1,84	1,16	2,69
40	1,28	2,41	1,30	2,69	1,65
50	1,78	1,72	1,15	2,23	2,99
55	1,81	2,14	1,65	1,02	3,53
	ΔE , r.h. 75% r.h		MC-3	MC-4	MC-5
dan	MC-1	MC-2			
0					
10	2,11	2,10	1,37	0,81	1,78
20	2,63	2,83	1,79	2,80	4,44
30	3,36	3,02	2,08	3,07	4,58
40	2,77	3,43	2,43	2,86	5,49
50	3,53	4,72	2,18	4,76	6,56
55	3,73	4,97	2,27	5,02	5,37

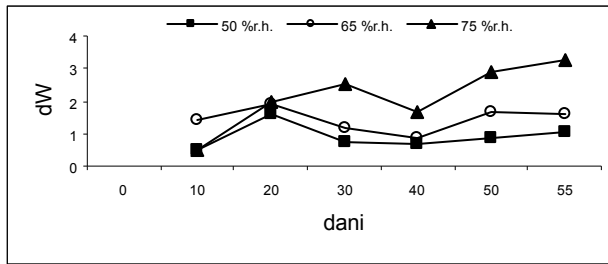

Slika 2. Izbjeljivanje površine mliječne čokolade, uzorak MC-1, prikazano kao promjena vrijednosti indeksa izbjeljivanja (mjereno kolorimetrijski), ovisno o vlažnosti zraka tijekom skladištenja. Uzorci su čuvani tijekom 55 dana u temperaturnom režimu: 12 sati pri 20 °C, 12 sati pri 29 °C

Fig. 2. Whitening surface of milk chocolate, sample MC-1, showing a change whitening index (measured colorimetrically), depending on humidity during storage. Samples were kept during 55 days in the temperature regime of 12 hours at 20 °C, 12 h at 29 °C

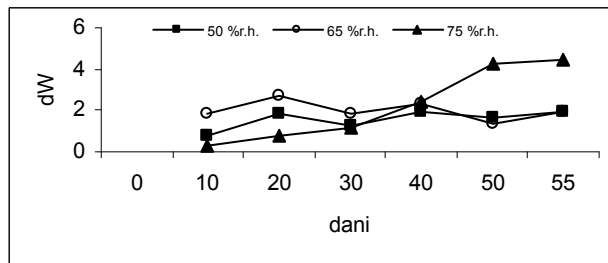

Slika 3. Izbjeljivanje površine mliječne čokolade, uzorak MC-2, prikazano kao promjena vrijednosti indeksa izbjeljivanja (mjereno kolorimetrijski), ovisno o vlažnosti zraka tijekom skladištenja. Uzorci su čuvani tijekom 55 dana u temperaturnom režimu: 12 sati pri 20 °C, 12 sati pri 29 °C

Fig. 3. Whitening surface of milk chocolate, sample MC-2, showing a change whitening index (measured colorimetrically), depending on humidity during storage. Samples were kept during 55 days in the temperature regime of 12 hours at 20 °C, 12 h at 29 °C

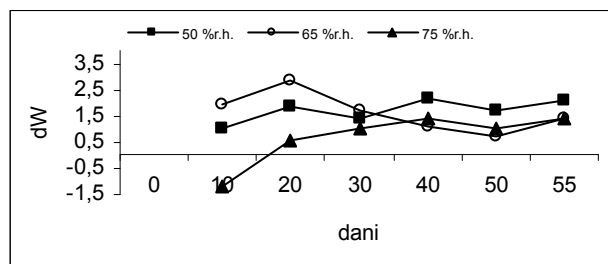

Slika 4. Izbjeljivanje površine mliječne čokolade, uzorak MC-3, prikazano kao promjena vrijednosti indeksa izbjeljivanja (mjereno kolorimetrijski), ovisno o vlažnosti zraka tijekom skladištenja. Uzorci su čuvani tijekom 55 dana u temperaturnom režimu: 12 sati pri 20 °C, 12 sati pri 29 °C

Fig. 4. Whitening surface of milk chocolate, sample MC-3, showing a change whitening index (measured colorimetrically), depending on humidity during storage. Samples were kept during 55 days in the temperature regime of 12 hours at 20 °C, 12 h at 29 °C

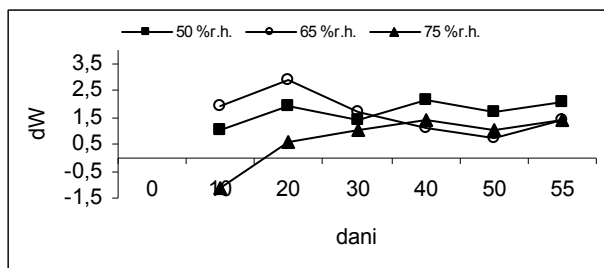

Slika 5. Izbjeljivanje površine mliječne čokolade, uzorak MC-4, prikazano kao promjena vrijednosti indeksa izbjeljivanja (mjereno kolorimetrijski), ovisno o vlažnosti zraka tijekom skladištenja. Uzorci su čuvani tijekom 55 dana u temperaturnom režimu: 12 sati pri 20 °C, 12 sati pri 29 °C

Fig. 5. Whitening surface of milk chocolate, sample MC-2, showing a change whitening index (measured colorimetrically), depending on humidity during storage. Samples were kept during 55 days in the temperature regime of 12 hours at 20 °C, 12 h at 29 °C

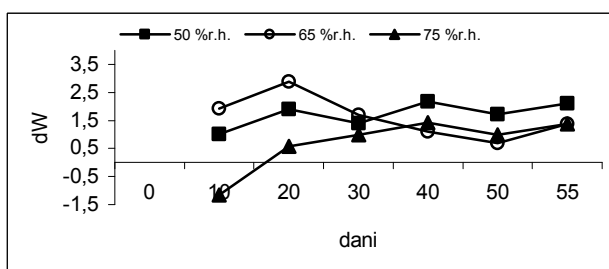

Slika 6. Izbjeljivanje površine mliječne čokolade, uzorak MC-5, prikazano kao promjena vrijednosti indeksa izbjeljivanja (mjereno kolorimetrijski), ovisno o vlažnosti zraka tijekom skladištenja. Uzorci su čuvani tijekom 55 dana u temperaturnom režimu: 12 sati pri 20 °C, 12 sati pri 29 °C

Fig. 6. Whitening surface of milk chocolate, sample MC-5, showing a change whitening index (measured colorimetrically), depending on humidity during storage. Samples were kept during 55 days in the temperature regime of 12 hours at 20 °C, 12 h at 29 °C

Pomoću diferencijalnog motridbenog kalorimetra (DMK) obavljena je analiza površine uzoraka čokolade prije skladištenja (kontrolni uzorak) te nakon skladištenja pri sljedećim uvjetima: relativna vlažnost prostora 50, 65 i 75 %, pri temperaturi 20 °C u trajanju od 12 sati te potom 12 sati pri 29 °C, tijekom 55 dana. DMK analizom dobiven je relativan sadržaj i omjer *masti* (kakaov maslac i ostale masti) i saharoze na površini čokolada. Relativan sadržaj i omjer masti i saharoze na površini ispitivanih uzoraka čokolade proporcionalan je entalpiji taljenja navedenih sastojaka.

Na Slikama 7 i 8 prikazane su entalpije taljenja saharoze i masti dobivene DMK analizom površina čokolada.

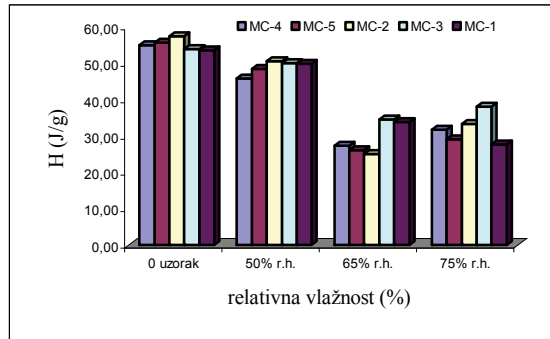

Slika 7. Entalpije taljenja saharoze dobivene DMK analizom površinskog sloja uzoraka mliječnih čokolada skladištenih pri različitim relativnim vlažnostima zraka i temperaturnom režimu 20 °C tijekom 12 sati te narednih 12 sati pri 29 °C, tijekom 55 dana

Fig. 7. Melting enthalpy of sucrose, DMK analysis of milk chocolate samples stored at different relative humidity and temperature regime 20° C during the next 12 hours and 12 hours at 29° C for 55 days

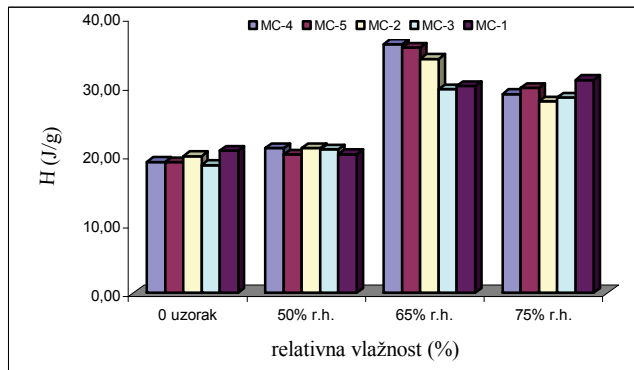

Slika 8. Entalpije taljenja kakaovog maslaca dobivene DMK analizom površinskog sloja uzoraka mliječnih čokolada skladištenih pri različitim relativnim vlažnostima zraka i temperaturnom režimu 20 °C tijekom 12 sati te narednih 12 sati pri 29 °C, tijekom 55 dana.

Fig. 8. Melting enthalpy of cocoa butter sucrose, DMK analysis of milk chocolate samples stored at different relative humidity and temperature regime 20° C during the next 12 hours and 12 hours at 29° C for 55 days

Iz rezultata je vidljivo da je kod svih uzoraka tijekom skladištenja pri povišenoj relativnoj vlažnosti (65 i 75 %) došlo do promjene u sastavu površinskog sloja koja se očitovala sniženjem udjela saharoze i povećanjem udjela masti. S druge strane, fluktuacija temperature tijekom skladištenja nije uzrokovala značajne promjene u sastavu površine čokolada pri relativnoj vlažnosti od 50 %. Kod

uzoraka čokolade MC-4, MC-5, MC-2, MC-3, MC-1 je tijekom skladištenja pri povišenoj relativnoj vlažnosti došlo do sniženja udjela saharoze, a porasta udjela masti na površini. Među navedenim uzorcima, najmanje promjene sastava površine čokolade bile su kod uzoraka MC-3 i MC-1 pri 65 % r.h. te uzoraka MC-3 i MC-2 pri 75 % r.h. Iz rezultata je vidljivo da su uzorci MC-4 i MC-5 za koje je zajedničko da su sadržavali karamelizirano mlijeko u prahu, imali nešto izraženiju migraciju masti ka površini.

Zaključak

Pojedini tipovi mlijeka u prahu te udio vlage u zraku prostora u kojima su uzorci čuvani imali su znakovit utjecaj na sivljenje površine ispitivanih čokolada. Pri tome su promjene kod pojedinih uzoraka, prije svega onih koji su čuvani u prostoru koji je sadržavao 75 % vlage u zraku toliko uznapredovale da su pored pojave bijele prevlake na površini proizvoda dovele i do promjene teksture čokolade koja je u unutrašnjosti postala krta i „suha“. Čokolade koje su sadržavale mlijeko u prahu sušeno na valjcima bile su otpornije na sivljenje zbog činjenice da mlijeko sušeno na valjcima sadrži viši udio slobodne mliječne masti koja je inhibitor sivljenja. Uzorci čokolada pripremljeni uz dodatak karameliziranog mlijeka pokazali su dobru stabilnost, a do značajnijih promjena došlo je tek pri vlažnosti zraka od 75 % i to najranije tek polovinom eksperimenta. Dodatak mlijeka u prahu sušenog raspršivanjem u proizvodnji čokolade doveo je do intenzivnijeg sivljenja površine čokolade. Razlog tome je njegova veća higroskopnost u odnosu na mlijeko u prahu sušeno na valjcima. Na osnovi rezultata dobivenih pomoću diferencijalnog motridbenog kalorimetra izvedeni su zaključci bitni za objašnjenje mehanizama izlaska masti na površinu čokolade. Na temelju analize sivog sloja sa površine posivljene čokolade ustanovljeno je da se tijekom vremena (55 dana), ovisno o vlažnosti zraka u prostoru u kojem su uzorci čuvani, mijenjao sastav sivog sloja. Najmanje promjene sastava desile su se pri čuvanju uzoraka pri vlažnosti zraka od 50 %. Pri višim vlažnostima zraka (65 i 75 %) došlo je do značajnije promjene sastava sivog sloja u kojem se povećavao udio masti, a smanjivao udio šećera. Iz dobivenih rezultata se može zaključiti da uslijed povećanja udjela vlage u zraku dolazi do otapanja šećera u površinskim slojevima čokolade pri čemu nastaju „pore“ koje omogućuju izlazak masti na površinu, a što je pojačano fluktuacijama temperature. Povećanje udjela masti u sivom sloju na površini posivljene čokolade ovisilo je o sastavu čokolade na isti način kao i kod praćenja promjene boje primjenom tristimulusnog kromametra. Naime, slobodna mliječna mast je utjecala na usporavanje migracije, odnosno uzorak koji je sadržavao mlijeko sušeno na valjcima imao je niži udio masti na površini proizvoda.

Literatura

- Aguilera, J.M., Michel, M., Mayor, G. (2004): Fat migration in chocolate: diffusion or capillary flow in a particulate solid?- a hypothesis paper, *J. Food Sci.* 69, 167-174.
- Ali, A., Selamat, J., Che Man, Y.B., Suria, A.M.(2001): Effect of storage temperature on texture, polymorphic structure, bloom formation and sensory attributes of filled dark chocolate, *Food Chem.* 72, 491-497.
- Bricknell, J. i Hartell, R.W.(1998): Relation of fat bloom in chocolate to polymorphic transition of cocoa butter, *J. Am. Oil Chem. Soc.* 75, 1609-1615.
- Brones, V., Aguilera, J.M.(2005): Image analysis of changes in surface color of chocolate, *Food Research International* 38, 87-94.
- Fong, E.P.(2004): Physico – chemical characteristics and sensory evaluation of milk chocolate and dark chocolate during storage. <http://www.ums.edu.my/ssmp/echocolate.htm> (21.4.2004.)
- Fryer, P., Pinschower, K.(2000): The materials science of chocolate. www.mrs.org/publications/bulletin (15. 12. 2000.)
- Ghosh, V., Ziegler, G.R., Anantheswaran, R.C.(2002): Fat, Moisture and Ethanol Migration through Chocolates and Confectionary Coatings, *Critical Reviews in Food Science and Nutrition* 42, 583-626.
- Hamond, E., Gedney, S.(2006): Fat Bloom. www.britanniafood.com (17.03.2006.)
- Keogh, K., Murray, C. Kelly, J., O’ Kennedy, B.(2004): Effects of the particle size of spray – dried milk powder on some properties of chocolate, *INRA, EDP Sciences* 84, 375-384.
- Kinta, Y., Hatta, T.: Composition and structure of fat bloom in untempered chocolate, *J. Food Sci.* 70, 450-452, 2005.
- Liang, B., Hartel, R.W. (2004): Effects of Milk Powders in Milk Chocolate, *J. Dairy Sci.* 87, 20-31, 2004.
- Loisel, C., Lecq, G. , Ponchel, G., Keller, G. Ollivon, M.(1997): Fat bloom and chocolate structure studied by mercury porosimetry, *J. Food. Sci.* 62, 781-788.
- Lonchamp, P. i Hartel, R.W. (2006): Surface bloom on improperly tempered chocolate, *Eur. J. Lipid Sci. Technol.* 108, 159-168.
- Momura, J. i sur.(1988): Fat blooming inhibitor, *Patent Number.* 4,726,959.
- Ransom – Painter, K.L., Willims, S.D., Hartel, R.W.: Incorporation of Milk Fat and Milk Fat Fractions into Compound Coatings Made from Palm Kernel Oil, *J. Dairy Sci.* 80, 2237 – 2248, 1997.
- Rousseau, D. (2006): On the porous mesostructure of milk chocolate viewed with atomic force microscopy, *Lebensm. Wiss. u. Technolo.* 39, 852 – 860.
- Seguine, E (2001): Diagnosing Chocolate Bloom, *The Manufacturing confectioner*, 45 – 50.
- Smith, W.K. , Cain, W.F., Talbot, G. (2007): Effect of nut oil migration on polymorphic transformation in a model system, *Food Chem.* 102, 656 – 663.
- Schmelzer, J.M., Hartel, R.W. (2001): Interactions of milk fat and milk fat fractions with confectionary fats, *J. Dairy Sci.* 84, 332 –441.
- Tietz, R.A. i Hartel, R.W. (1998): Relation of Fat Bloom in Chocolate to Polymorphic Transition of Cocoa Butter, *J. Am Oil Chem. Soc.* 75, 1609-1615.

- Tietz, R.A. i Hartel, R.W. (2000): Effects of minor lipids on crystallization of milk fat-cacao butter blends and bloom formation in chocolate, *J. Am. Oil Chem. Soc.* 77, 763-771.
- Timms, R.E. (2003): Confectionery fats handbook. Oily lipid library and Lipid Technology.
- Toro-Vazquez, J.F., Rangel-Vargas, E., Dibildox-Alvarado, E., Charo-Alonso, M.A. (2005): Crystallization of cocoa butter with and without polar lipids evaluated by rheometry, calorimetry and polarized light microscopy, *Eur. J. Lipid Sci Technol.* 107, 641 – 655.

Influence of milk powder and storage conditions on stability of chocolates

S. Škrabal¹, D. Šubarić², B. Miličević¹, Đ. Ačkar²,
J. Babić², R. Miličević³

¹*Zvečevo dd, Kralja Zvonimira 1, 34000 Požega, Croatia*

²*University of Josip Juraj Strossmayer in Osijek, Faculty of Food Technology Osijek, Franje Kuhača 20, 31000, Osijek, Croatia*

³*University College of Applied Sciences in Safety, I. Lučića 5, 10000 Zagreb, Croatia*

Summary

One of the most significant problems in confectionery industry is development of fat bloom which results in gray appearance and crumbly structure of chocolate and chocolate products. Although fat bloom has been studied extensively for many years, its actual mechanisms are not completely understood due to complexity of systems and interactions. Influence of different milk powder types on fat bloom of chocolate was investigated in this research. For this purpose, milk chocolates with spray dried and skimmed milk powder were prepared. To induce development of bloom, chocolate samples were exposed to temperature cycling between 20 and 29 °C at 12 hr intervals at 50, 60 and 75 % r. h., respectively during 55 days. Color changes were monitored by tristimulus chromameter and changes in grey layer composition were monitored by DSC. Results showed that type of milk powder and storage conditions had significant influence on fat bloom, which is especially pronounced at higher humidities, where hygroscopy caused additional blooming. Results of DSC measurements can be used in revealing of fat blooming.

Keywords: milk chocolate, fat bloom, DSC, milk powder

Application of NIR spectroscopy for monitoring quality of surimi

UDC: 664.951.81 : 543.4

D. Valinger¹, J. Gajdoš Kljusurić^{1*}, D. Kovačević², Ž. Kurtanjek¹

¹*University of Zagreb, Faculty of Food Technology and Biotechnology, Pierottijeva 6, 10000, Zagreb, Croatia*

²*University of Josip Juraj Strossmayer in Osijek, Faculty of Food Technology Osijek, Franje Kuhača 20, 31000, Osijek, Croatia*

Summary

Non-invasive spectroscopy in the near red range from 899 - 1699 nm (NIR) was applied with the aim to analyze commercial samples of surimi and analogs of sea shrimp. In this paper the aim was to investigate the possibility of recording reflectance samples for potential monitoring in the production process and sorting of samples according to the quality, in order to prevent adulteration, and classification. The surimi as shrimp analogs spectra samples were monitored at 4 °C room temperature of 21 °C over time intervals (0, 30, 60, 120 and 240 min) on both sides of the samples. The samples were treated by cooking in water and in a microwave oven in time intervals: 0; 0.5; 1 and 2 min. Analysis of the spectrums reveal changes in specific wave lengths of 919, 1177, 1201, 1343, 1458 and 1495 which correspond to O-H, C-H and N-H bonds that indicates possibility of determination of fat, protein and water in surimi and shrimp analogues enabling use of NIR for on-line monitoring of quality and selection.

Keywords: NIR spectroscopy, surimi, food quality

Introduction

One of the main challenges of food industry is to obtain reliable information of the products offered on the market (Růžičková and Šustova, 2006). Use of spectroscopy in the NIR region (near infrared region) allows a wide range of applications in the food chain production, controlling the quality indicators of raw materials, intermediary products and final products (Růžičková and Šustova, 2006) in order to provide a guarantee for consumers (Damez and Clejron, 2008). NIR spectroscopy is a method used especially for the determination of the main constituents (dry matter, proteins, fat and saccharides), for example in the case of surimi.

Surimi, as an intermediate fish product defined as a refined fish protein product prepared by washing mechanically deboned fish and minced and washed fish is stabilized by cryoprotectants (Udin et al., 2006).

*.jgajdos@pbf.hr

Previous studies have used NIRs to assess the protein and water content of whole fish and surimi with satisfactory results (Uddin et al., 2005; Uddin et al., 2006; Folkestad et al., 2008; Uddin et al., 2006a; Shimamoto et al., 2003).

The objective of the presented study is to evaluate the use of NIR spectroscopy for the quantitative analysis of different surimi samples for the high-speed determination of fat, protein and water content tested on different surimi samples. Explored was the possibility if NIRs could find its practical application in the production process as well as in the market control.

The technique of NIR spectroscopy is based on the electromagnetic absorption at the near-infrared region but the spectral analysis has to be assisted with various chemometric techniques, such as multiple linear regression analysis, MLRA, principal component analysis, PCA and canonical variate analysis, CVA (Ding and Xu, 1999; Alishahi et al., 2010).

Materials and methods

Surimi samples

Two commercial surimi samples, from two different manufacturers were used in this study. Land of origin for the first surimi, samples P, was China and the second sample, L, was from Lithuania. P surimi samples had 42 % of white fish meat and L samples had 29 % of white fish meat. For both manufacturers, Croatia was importer country and they were purchased from a supermarket.

Sample preparation

After purchasing all the samples were kept for two days under controlled conditions in freezer at temperature of -13 ± 1 °C prior to experiments. Measurements using NIR instrument were carried immediately after extraction of each sample from the freezer without any mechanical or chemical treatment prior to NIR spectroscopy. Each sample was unwrapped from foil and put on clean surface. The probe of NIR instrument was then leaned upon the sample slightly touching it. Both sides (white and red) of surimi were tested.

NIR measurements

Surimi NIR spectra were collected over the range of 904-1699 nm using a Control Development, Inc., NIR-128-1.7-USB/6.25/50µm shown in Fig. 1 with installed Control Development software Spec32.

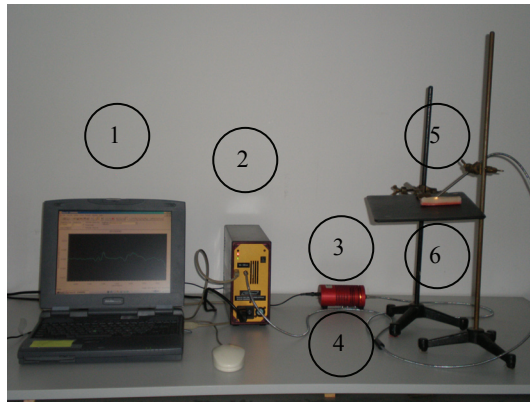

Fig. 1. NIR instrument connected to PC (Laptop with Spec32 software (1), NIR instrument (2), source of light (3), optical cable (4), measurement probe (5), surimi sample (6))

Modelling

NIR spectra were recorded in EXCEL format and imported to STATISTICA v. 8. software for evaluation. Imported are the original spectra and pre-processed spectra by Savitsky-Golay “smooth” algorithm for data filtering which is available by Control Development software Spec32. Firstly, the data are collected in a matrix **X** with samples placed in rows and NIR intensities are variables placed in columns. Each vector of the variables is auto-scaled with respect to each variable (wave length) sample average and standard deviation:

$$\mathbf{X}_{i,j} \leftarrow \frac{X_{i,j} - \bar{X}_j}{\sigma_j(X_j)} \quad (1)$$

Assuming normal distribution, for each variable sample statistics is calculated by:

$$\bar{\mathbf{X}}_j = \frac{1}{n} \cdot \sum_{i=1}^n X_{i,j} \quad \sigma_j^2 = \frac{1}{n-1} \cdot \sum_{i=1}^n (X_{i,j} - \bar{\mathbf{X}}_j)^2 \quad (2)$$

The scaled data matrix **X** is approximated by the projections into the subspace of principal components **P**:

$$\mathbf{T} = \mathbf{X} \cdot \mathbf{P} \quad (3)$$

The principal components form the loading matrix **P** and all the scores are collected in the target matrix **T**. The principal component model reconstructs the original data by the relation:

$$\mathbf{X} = \mathbf{T} \cdot \mathbf{P}^T + \mathbf{E} \quad (4)$$

In Eq. 4. \mathbf{E} is the error matrix of the residuals between the experimental data and the principal component projections. Components of the error matrix are assumed to be a result of all random factors included in the experiment, such as instrument error, sample treatment and laboratory conditions. Due to high colinearity between spectra data, very significant reduction in dimension is obtained. The principal component vectors are determined by sequential maximization of the variance of the projected data with assumption of the sample based covariance. The principal components are eigenvectors of the sample covariance, while the corresponding eigenvalues are the variances:

$$\mathbf{X}^T \cdot \mathbf{X} \cdot \mathbf{P}_i = \lambda_i \cdot \mathbf{P}_i \quad (5)$$

Variance of the data matrix is given by the sum:

$$\sigma^2(\mathbf{X}) = \sum_{i=1}^m \lambda_i^2 \quad (6)$$

The method enables extraction of the essential deterministic information from large sets of spectra correlated data by reduction of the dimension by only the first r significant principal components ($\mathbf{P}_1, \mathbf{P}_2 \dots \mathbf{P}_r$).

In this work the main purpose for principal component analysis (PCA) is to apply cluster analysis in the plane of the first two principal components for discrimination of sample origin and detection of possible product adulteration.

Results and discussion

In Fig.1 is shown the experimental setup with NIR instrument, optical cables and a sample holder. Each spectrum was digitally recorded and saved in EXCEL format for further analysis. Numerical evaluation of principal component analysis was performed by statistical software STATISTICA v. 8. Four samples of each surimi manufacturer, labelled as L and P, were subject to NIR analysis on upper and lower side of each sample. The data matrix \mathbf{X} (8x796) is composed of 8 rows, 4 samples of L and P, and 796 NIR reflectance in columns. In Fig. 2 are presented two typical samples NIR reflectance spectra for L and P samples. In order to perform PCA analysis applied is numerical derivation as presented in Fig. 3. For a first estimate of the spectra similarities evaluated are Pearson's correlation coefficients. The obtained matrix of cross-correlation coefficients is given in Table 1. The spectra are highly correlated as proved by very high coefficients with average value $R = 0.952$. Correlation between spectra of the same sample P is very high, $R = 0.99$, while for L samples is $R = 0.957$. However, there is noticeable decrease in the cross correlation, $R = 0.91$, between the two types of surimi products, L and P, which leads to possible recognition of samples based on correlation of full NIR spectra.

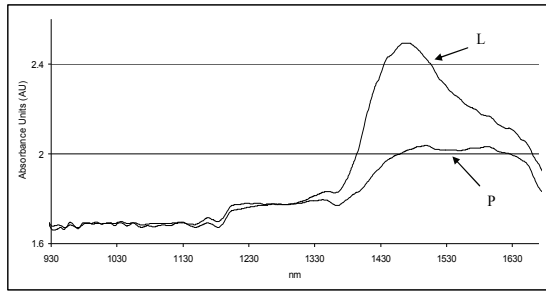

Fig. 2. NIR spectra for surimi samples P and L

Sample of NIR spectra for both surimi manufacturers are shown in Fig. 2. and their corresponding derivatives in Fig. 3.

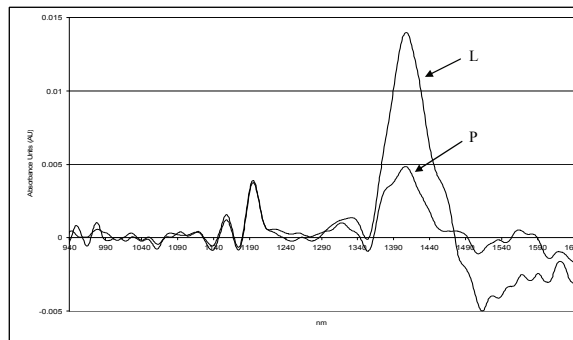

Fig. 3. Samples of the corresponding derivatives of NIR spectra for surimi samples P and L

Table 1. Matrix of correlation coefficients for the first derivative of NIR spectra for L and P surimi samples. Average correlation between L samples is $R_{L,L} = 0.957$, for P samples is 0.990, and average cross-correlation between L and P samples is $R_{L,P} = 0.911$

Variable	L1	L2	L3	L4	P1	P2	P3	P4
L1	1.00	1.00	0.99	0.93	0.93	0.93	0.90	0.95
L2	1.00	1.00	0.99	0.94	0.93	0.93	0.90	0.95
L3	0.99	0.99	1.00	0.89	0.96	0.96	0.94	0.97
L4	0.93	0.94	0.89	1.00	0.83	0.84	0.79	0.87
P1	0.93	0.93	0.96	0.83	1.00	0.99	0.99	0.99
P2	0.93	0.93	0.96	0.84	0.99	1.00	0.99	0.99
P3	0.90	0.90	0.94	0.79	0.99	0.99	1.00	0.99
P4	0.95	0.95	0.97	0.87	0.99	0.99	0.99	1.00

In order to apply NIR spectra for sample classification according to product manufacturer principal component analysis (PCA) is applied. Firstly are determined eigenvalues for the data matrix X composed of four independent measurements for

each manufacturer, L and P samples. Eigenvalues are calculated by numerical matrix inversion algorithm provided by STATISTICA v.8 software. Results are presented in Table 2. and graphically as scree plots in Fig. 4. The pronounced affect of the first two eigenvalues is observed and by the cumulative effect is observed that 99.5 % of variance is accounted by the first two principal components.

Table 2. Eigenvalues of the covariance matrix of NIR spectra for L and P samples

Value number	Eigenvalue	% Total variance	Cumulative Eigenvalue	Cumulative %
1	605.357	79.9679	605.357	79.968
2	147.962	19.5459	753.320	99.513
3	2.790	0.3686	756.111	99.882
4	0.516	0.0681	756.627	99.950
5	0.285	0.0376	756.912	99.988
6	0.061	0.0080	756.973	99.996
7	0.026	0.0035	757.000	100.000

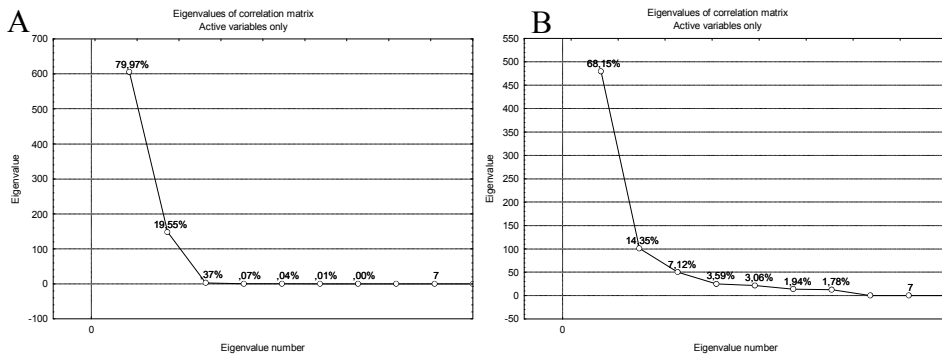

Fig. 4. Scree plots for the NIR spectra (A) and their derivatives (B)

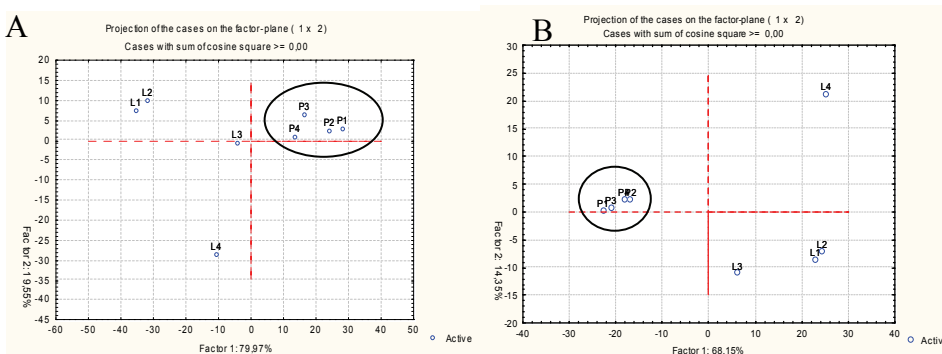

Fig. 5. Classification of L and P samples based on NIR spectra (A) and their corresponding derivatives (B) in the plane of the first two principal components

In Fig. 4 are compared scree plots for NIR spectra and its first derivative. The similar distribution of eigenvalues is obtained, showing the “knee point” after the second eigenvalue, at which occurs separation of deterministic information from random effects. However, account of random effects in the derivative of the spectra is higher, about 10 %. Projections of the samples on the first two principal component planes are presented in Fig 4. Clustering of the samples according to product manufacturer is observed in both cases, PCA 1-2 of NIR spectra Fig. 5A, and PCA 1-2 of the first derivatives Fig. 5B. The clustering effect based on NIR first derivative is more pronounced compared to the original NIR spectra, yielding very close scores for P and distinct from L samples.

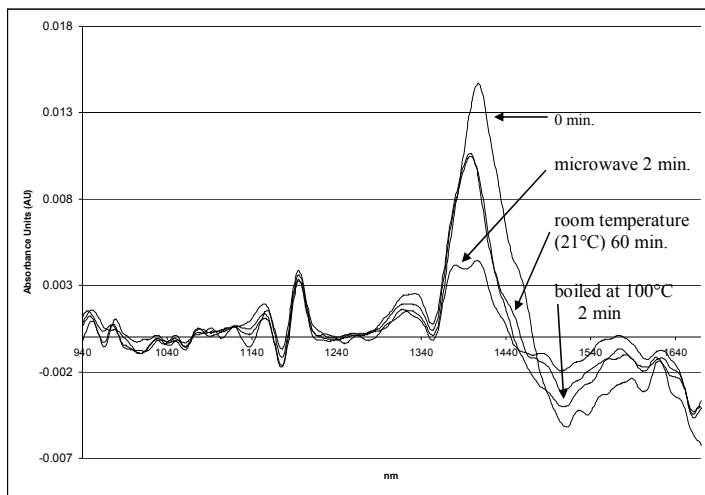

Fig. 6. Derivatives of NIR spectra of four surimi samples L after thermal treatment. First sample was recorder in immediately after it was taken from a freezer (-12 ± 1 °C), i.e. at time 0 min. The second was micro waved for two minutes, the third was thawed by leaving for 60 minutes at room temperature (21 °C) and the fourth sample was boiled in water at 100 °C for 2 minutes.

The scores of L samples show relatively large distance and a sub-cluster for L1 and L2 samples. Nevertheless, P and L scores are clearly discriminated by the second principal component, i.e. all P samples are on the left-hand side and L samples are on the right hand side. These results support the main objective to use NIR and PCA analysis for sample recognition and possible detection of product adulteration.

Effects of various thermal treatments of surimi can be monitored by NIR spectra. In Fig. 6 are given the effects on the first derivative after sample thawing for 60 minutes at room temperature, after 2 minutes of exposition in a microwave oven, and after boiling in water for 2 minutes at temperature 100 °C. These are

preliminary results, which support the main hypothesis that NIR spectrometer with optical cables is applicable for on-line process monitoring and control.

Conclusions

A NIR process analyzer with optical cables proved to be versatile and sufficiently accurate for recognition of surimi origin and for monitoring of thermal processes. Applied is principal component analysis for sample clustering and sample origin classification. The analysis is applied on auto-scaled data and numerical derivatives of the smoothed spectra. The scree plot of eigenvalues reveals that the first two principal components account for 90 % of extracted deterministic information. Based on scores on the plane of the first two principal components successfully are performed classifications of two surimi products of different origin (manufacturer).

By NIR spectra are monitored effects of applied thermal treatments thawing, micro-wave frying and boiling. Each of the thermal treatments has a characteristic NIR signature enabling on-line process monitoring and control.

References

- Alishahi, A., Farahmand, H., Prieto, N., Cozzolino, D. (2010): Identification of transgenic foods using NIR spectroscopy: a review, *Spec. Acta A.* 75, 1–7.
- Damez, J-L., Clerjon, S. (2008): Meat quality assessment using biophysical methods related to meat structure, *Meat Sci.* 80, 132–149.
- Ding, H.B. and Xu, R.J. (1999): Differentiation of Beef and Kangaroo Meat by Visible/Near-Infrared Reflectance Spectroscopy, *J Food Sci.* 64 (5), 814–817.
- Folkestad, A., Wold, J.P., Rørvik, K-A., Tschudi, J., Haugholt, K.H., Kolstad, K., Mørkøre, T. (2008): Rapid and non-invasive measurements of fat and pigment concentrations in live and Slaughtered Atlantic salmon (*Salmo salar L.*), *Aquacul.* 280, 129–135.
- Růžičková, J., Šustová, K. (2006): Determination of Selected Parameters of Quality Of the Dairy Products by NIR Spectroscopy, *Czech J. Food Sci.* 24 (6), 255–260.
- Shimamoto, J., Hasegawa, K., Hattori, S., Hattori, Y. and Mizuno, T. (2003): Non-destructive determination of the fat content in glazed bigeye tuna by portable near Infrared spectrophotometer, *Fisheries Sci.* 69, 1247–1256.
- Spec32 software (version 1.32, Control Development Inc., South Bend, USA)
- StatSoft, Inc. USA, (2009): STATISTICA (Data Analysis Software System) ver. 8.0.
- Uddin, M., Okazaki, E., Turza, S., Yumiko, Y., Tanaka, M., Fukuda, Y. (2005): Non-destructive Visible/NIR Spectroscopy for Differentiation of Fresh and Frozen-thawed Fish, *J. Food Sci.* 70 (8), 506–510.
- Uddin, M., Okazaki, E., Fukushima, H., Turza, S., Yumiko, Y., Fukuda, Y. (2006): Nondestructive determination of water and protein in surimi by near-infrared spectroscopy, *Food Chem.* 96, 491–495.
- Uddin, M., Okazaki, E., Uddin Ahmad, M., Fukuda, Y., Tanaka, M. (2006a): NIR spectroscopy: A non-destructive fast technique to verify Heat treatment of fish-meat gel, *Food Control.* 17, 660–664.

Liquefied wood – potential application in wood industry

UDC: 630*83

A. Antonović*, V. Jambreković, J. Ištvančić, N. Španić

University of Zagreb, Faculty of Forestry, Wood Technology Department, Institute for Material Technologies, Svetošimunska cesta 25, 10002 Zagreb, Croatia

Summary

Wood is one of the most abundant and accessible renewable resources available to mankind. All the main chemical wood components are high-weight-molecular polymers and form an interwoven network in the wood cell wall; consequently we can say that wood is a natural polymer. With growing emphasis on sustainable development, new methods involving alternative wood use are being explored. Great efforts are directed to new technology development for achieving effective wood utilization, and obtaining ecologically acceptable materials on their base. Particularly interesting is application of wood as a feedstock for producing polymers that could replace a part of the conventional fossil oil based plastics. Wood liquefaction is novel method, and its aim is to convert wood material in biodegradable polymer materials and increase percentage of wood utilization. Maximum attention attracted wood liquefaction in presence of some organic reagents and the most interesting are two methods. The first one is the preparation in presence of phenol, which resulted in liquefaction products rich with phenol units. The second liquefaction method was achieved in presence of polyhydric alcohols. Therefore, an overview of previous researches related to wood liquefaction and its potential application in the wood industry was made in this paper.

Keywords: liquefied wood, polymer materials, phenols, polyhydric alcohols

Introduction

Development of the novel types of materials at the beginning of the new millennium certainly can not be imagined without renewable resources. There are several main reasons for this, and among them the most important are certainly awareness of a lesser and lesser availability of non-renewable resources – fossil fuels (oil, coal, natural gas), but also the harmful consequences, their use in the last two centuries have left, on environment.

The global use of polymers has experienced decades of consistent growth and is showing no signs of reduction, especially as developing countries are poised to increase their per capita consumption. The growth in polymer consumption is in principle limited by finite oil reserves. However, polymer waste and its incompatibility with nature is often more visible and in some cases dangerous problem. The solution to both problems could be increasing the use of renewable

* alan.antonovic@zg.htnet.hr

resources used for polymer production. By improving properties of polymers such as biodegradation, polymers would remain in the natural carbon cycle.

Lignocellulosic materials and biomass are very important natural renewable raw materials. Wood, as a dominant resource, is the most commonly used material among all the "engineering" materials. As a consequence, wood takes place of great importance in the global picture of available raw material resources. Due to the continuing increase in demand for wood as well as new restrictions on wood products, demand for wood products with improved properties and performance is higher than ever before in history.

The primary production of biomass, which is narrowly defined as materials of terrestrial plant origin, is about 172 billion tons/year on land of which about 82% is the existing lignocellulosic materials in forests. Wood, therefore, is the most important component. Other lignocellulosic materials include agricultural residues, water plants, grasses, and other plant substances. These materials are unique in their chemical composition as well as their chemical, physical, and mechanical properties (Antonović, 2010).

From the chemical point of view, wood consists of 40-50 % cellulose, 20-30 % hemicellulose and 20-30 % lignin, along with minor content of ash (mineral substances) and extractives. All the main wood components are high-weight-molecular polymers and form an interwoven network in the wood cell wall; consequently we can say that the wood is a natural polymer (Fengel and Wegener, 1989).

Great efforts are directed to new technology development for achieving effective wood or biomass utilization, and obtaining ecologically acceptable materials on their base. Maximum attention attracted wood (biomass) liquefaction in presence of some organic reagents and their application in preparation of polymer materials. According to above, the aim of this paper was to make a review of previous researches related to wood liquefaction and its potential application in the wood industry.

Previous Researches

Wood liquefaction

Wood chemical components possess many active functional groups susceptible to reaction (Fig. 1 and 2). These reaction sites or functional groups are primary and secondary hydroxyls, carbonyls, carboxyls (ester), carbon-carbon, ether, and acetal linkages. Virtually every type of reagent capable of reacting with these functional groups can be applied to wood, and the literature is full of examples. Hence, based on the variety of functional groups, etherification, esterification, alkylation, hydroxyalkylation, graft copolymerization, cross linking, and oxidation have been conducted to produce a series of products with many applications (Hon, 1996).

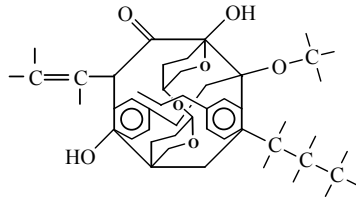

Fig. 1. A simplified illustration of functional groups in lignocellulosic materials (Hon, 1996)

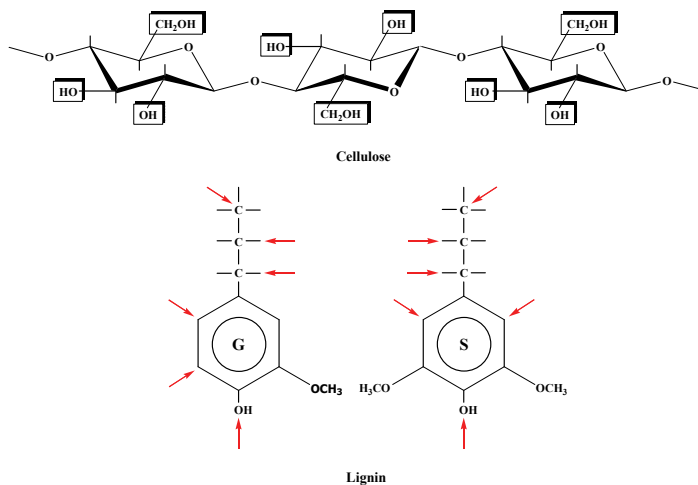

Fig. 2. Potential sites for chemical reactions in cellulose and lignin (Hon, 1996)

One approach, that has been researched last two decades, is to chemically derivate the wood components and thus increase their solubility in selected solvents. The dissolved macromolecules are then used in preparing useful polymeric materials. Another approach is to partially degrade the macromolecules to smaller soluble oligomers which are then used as feedstock for further use. Very often both methods overlap slightly, meaning that a limited degree of degradation takes place during the derivation and/or dissolution process. Such is indeed the case in wood liquefaction in which wood reacts with different types of reagents under elevated temperatures and in the presence of catalysts to yield a liquid product mixture known as liquid wood (Fig. 3). Liquefaction comprises a complex set of reactions taking place on the polymeric components of wood. They include derivatization such as esterification or etherification of free hydroxyl groups in cellulose or lignin as well as reactions that break the polymer chain of cellulose. In addition, liquefaction is affected by

physical constraints on wood reactivity such as the high crystallinity of cellulose. The tight packing of cellulose in the crystalline domains makes the reaction kinetics of otherwise reactive functional groups dependent on the diffusion of reagents into the tightly packed system. To overcome this limitation and speed up the liquefaction, increasingly harsh catalysts and reaction conditions, mainly mineral acids and high temperatures, have been employed.



Foto: Antonović, 2006

Fig. 3. Liquefied wood with liquefaction reagents mixture glycerol/H₂SO₄ (100/3)

After the discovery of the wood liquefaction phenomena, researches of different liquefaction parameters were conducted (types and ratios of reagents or solvents, catalysts types, liquefaction times and temperatures, wood or biomass species, anatomical part and sample granulations), in terms of (1) increasing of biomass concentration in liquefaction mixture, (2) achieving the real liquefaction degree with respect to solubility properties of liquefied biomass in organic solvents, (3) comprehension and understanding of the wood liquefaction mechanism, and (4) further application.

At the present time, several solvent systems of wood liquefaction can be identified in the previous researches, and that are processes which use phenols (Lin et al., 1997; Acemioğlu and Alma, 2002; Lee et al., 2002a), cyclic carbonates (Mun et al., 2001; Xie and Chen, 2005), ionic liquids (Honglu and Tiejun, 2006), dibasic esters without hydroxyl groups (Wei et al., 2004; Wei et al., 2005), and polyhydric alcohols (Kurimoto et al., 1999; Antonović, et al., 2006). The majority of attention was dedicated to application of liquefied wood in preparation and modification of resol- (Lee and Liu, 2002) and novolac-type phenol-formaldehyde resins (Alma et al., 1996; Lee et al., 2002b; Santana and Baumann, 1996; Hassan et al., 2009), urea-formaldehyde resins (Antonović, 2008; Antonović et al., 2009; Antonović et al., 2010), melamine-formaldehyde and melamine-urea-formaldehyde resins (Kunaver et al., 2010a), polyurethane resins (Kurimoto et al., 2000; Kurimoto et al., 2001; Wei et al., 2004; Kunaver et al., 2010b) and foams (Alma and Shiraishi, 1998; Lee et al., 2002c; Yao et al., 1996), saturated and unsaturated polyesters, isocyanate (Tohmura et al., 2005)

and epoxy resins (Nonaka et al., 1997; Kobayashi et al., 2000; Kobayashi et al., 2001; Xie and Chen, 2005), coatings (Budija et al., 2009a and 2009b) and their further application in novel types of materials, which have potential application in the wood industry. However, liquefaction reactions with phenols and polyhydric alcohols are the most interesting in the previous researches and literature, which will be more presented in further text.

Wood liquefaction with phenol

Several previous studies on the mechanism of wood components liquefaction with phenol were introduced. They showed that the phenolysis of wood components in the presence of an acidic catalyst resulted in dozens or even hundreds of different reactions that compete with each other. The mechanism of polysaccharides liquefaction (cellulose and hemicellulose), which are the main substance of wood quantity, happens with phenol using catalyst, through phenolysis of glucosidal bond. Appropriate glucosids were obtained through polysaccharides liquefaction with phenol. The reaction between polysaccharides and phenols is more complex than the reaction between polysaccharides and alcohols. The cause is phenol properties. Using phenols we develop substances with higher molecular weight, which prolong reaction time. The polysaccharides liquefaction time depends on solvent properties (Tišler, 2002; Grbac et al., 2003). Zhang et al. (2006) explored the mechanism of cellulose liquefaction in phenol. They indicated that pyranose, resulting from cellulose decomposition, can be combined to form the phenol hydroxyl and benzyl derivatives, which retained the characteristic phenolic functional groups.

Furthermore, due to the degradation of lignin in the presence of phenol, a variety of phenol compounds such as guaiacol, coniferyl alcohol, vanillin, etc. occur. Lignin liquefaction mechanism in the presence of phenol was studied with acid catalysts as well without them. They chose a model lignin component, guaiacil glycerol- β -guaiacil ether (GG), and found that guaiacol, which was formed during the degradation of GG at high temperatures without catalyst, homolitically dissolve to different radicals, which are capable for binding with phenol and formaldehyde (Lin et al., 1997).

Acemioğlu and Alma (2002) explored the kinetics of the wood phenolysis reaction in the presence of HCl as catalyst at a temperature of 60-150 °C during different reaction time. The results showed that about 90 % of wood can be liquefied in phenol at a temperature of 150 °C. However, only 30 % of phenol was found to react with wood components. Furthermore, the findings associated with the enthalpy activation showed that the wood phenolysis have a dominant endothermic nature of the reaction.

Lee and Ohkita (2003) showed that wood can be rapidly liquefied in the phenol at supercritical temperatures. Under these conditions, over 90 % of wood was liquefied for 30 seconds, and the properties of the product were similar to those

obtained by conventional liquefaction methods. Furthermore, Honglu and Tiejun (2006) used ionic liquids based on the imidazole as reagents for wood liquefaction, and found that by using this method quick and complete liquefaction at 120 °C for 25 min without an acidic catalyst can be achieved.

Wood liquefaction with polyhydric alcohols

Unlike liquefaction with phenol, the polysaccharides liquefaction mechanism with polyhydric alcohols occurs by alcoholise of glucosidal degradation. When using these polyhydric alcohols, anomer hydroxyl groups reduction end groups or the one from liberated glucose are protonised or alcoholised, so we get the same glycoside as in alcoholised mentioned before. Also, as in liquefaction with phenol, at the polysaccharides liquefaction in polyhydric alcohols first incurred the corresponding glucosides. Due to decomposition and reaction with the polyol, the liquefaction method converts wood components in reactive molecules (Tišler, 2002; Grbac et al., 2003).

The properties of newly established resins with liquefied wood are dependent not only on the lignocellulosic materials, but also on the size of wood particle. Generally, we can say that average size of wood particle (about 120 mesh) give composites of better performance and properties than those from smaller or bigger particles (Antonović, 2009).

In previous studies, from the polyhydric alcohols for wood liquefaction most commonly used are ethylene glycol (EG), diethylene glycol (DEG), dipropylene glycol (DPG), polyethylene glycol (PEG-400), glycerol, 1,6-hexandiol and 1,4-buthandiol etc., as well as their mutual mixtures in different ratios. Sulphuric, phenolsulphuric, phosphoric, hydrochloric and oxalic acid were used as catalysts. It should be noted that the use of acid catalysts leads to the recondensation of already decomposed wood components, which is a negative phenomenon. Various authors combined the liquefaction parameters, making it possible to perform wood liquefaction at temperature up to 350 °C, at normal pressure, and the time interval between 15-180 minutes (Tišler, 2002).

Recently, studies have appeared and promising results regarding the improvement of wood liquefaction procedures in polyhydric alcohols, in terms of reducing the ratio of wood/solvent. Thus, Kobayashi et al. (2005) studied the effect of treating wood with ozone in gaseous or liquid phase on the liquefaction process, and showed that it can be easily liquefied from untreated wood. Obtained liquefied wood had a very high ratio of wood/solvent, and the wood is pre-treated with ozone in the liquid phase. They showed that liquefied wood with a ratio of wood/solvent of 2:1 has sufficient fluidity to be activated as a starting material for chemical products, and it is possible to increase the content of the final wood products.

Kržan and Kunaver (2006) showed that wood can be effectively liquefied using microwave radiation as a source of heat. This method proved to be a quick way

to heat the reaction mixture to temperatures above 250 °C, causing the acceleration of liquefaction process. For example, when only glycol and organic acid anhydrides are used with the addition of phosphoric acid as the catalyst, complete liquefaction can be reached in 20 min. Higher content of liquefied wood are achieved at higher radiant power (300-700 W), longer irradiation time (5-20 min) and higher concentrations of phosphoric acid. Obtained liquefied wood had a complex composition of low molecular compounds, whose chemistry is not studied in detail. Variation of the liquefaction reactants showed that these procedures can use a wide range of reagents (glycol and anhydrides), commonly used in the formulations of resins, adhesives and coatings, without reducing efficiency. In fact, this leaves considerable freedom in designing the chemical structure of liquefied wood components that can be best suit to their end use. Furthermore, the results of using different types of wood species indicate that these liquefaction parameters can be applied to many hardwoods. The method of heating with microwave radiation showed promising application in the rapid development of laboratory experiments.

Generally, the wood liquefaction procedures with polyols are very simple. Their performance is not demanding, they do not use high pressure or very high temperatures, which makes experiments simpler.

Liquefied wood application

Phenol-formaldehyde resins

Lee and Chen (2008) liquefied the Japanese cedar wood using phenol with sulphuric and hydrochloric acid as catalysts. Then the liquefied wood reacted with formaldehyde, and thus prepared novolac-type phenol-formaldehyde resin. The results showed that the reaction of liquefied wood with formaldehyde was exothermic reaction, and thus formed a hard resin without additional heat. Because of liquefaction with two types of catalysts, two types of resins were designed. Both obtained novolac-type resins were used for the production of moulded products. Obtained products were made by mixing these resins with wood flour, hardener and zinc stearate in the weight ratio of 60:30:10:1 and hot pressed at 200 °C for 10 min.

Lee et al. (2002b) liquefied waste paper (newsprint, corrugated paperboard and business paper) in presence of phenol with the acid catalyst. The results showed significant difference in the liquefaction degree, due to different chemical composition. Obtained phenolysis products showed good properties of thermal flow and reactivity as well as in phenolated wood and commercial novolac-type phenol-formaldehyde resin. From that type of resin thermo stable moulded products were later obtained, which had the flexibility and thermal stability comparable with those obtained with the commercial novolac resin. The flexure

properties are further improved by co-condensation reaction between non-reacted phenol in the phenolysis products and formaldehyde.

Some authors have shown that phenolic adhesives made of five parts of wood and two parts of phenol have the same adhesive properties as well as commercial phenolic adhesives. Gluing of veneer thickness of 1 mm was carried out in the hot-press for 30 seconds at a temperature of 120-130 °C. Pressing temperature was almost 15 °C lower than the temperature required for commercial phenolic adhesives (Tišler, 2002).

A survey, in which the wood bark was liquefied with phenol in the presence of sulphuric acid as catalyst, showed that all anatomical parts of wood can be used for liquefaction. After setting a certain density with formaldehyde, a new type of phenol-formaldehyde resin was obtained. Bark wood has replaced up to 33 % of phenol-formaldehyde resin in the mixture. Lee and Liu (2003) liquefied wood bark in the presence of phenol with sulphuric and hydrochloric acid as catalyst. They researched the properties of resins prepared from liquefied bark, as well as potential use of liquefied bark-based resins in particleboards production. The results showed satisfactory bending and tensile strength (delamination).

Wood liquefaction with phenol in alkali medium leads to reaction mixture with a large amount of non-reacted phenols. Properties of resins significantly change depending on the ratio of phenol and aqueous NaOH. They contain more phenols; have lower molecular weight and melting point, but better mechanical properties (Tišler, 2002).

Lee et al. (2002) prepared resol-type phenol-formaldehyde resin by reaction between liquefied wood and formaldehyde under alkaline conditions. Such resin was successfully applied in the production of phenolic foams using appropriate combination of foaming agents. The obtained foams showed satisfactory densities and compressive properties compared to those obtained from conventional foam of resol resin.

Hassan et al. (2009) liquefied southern pine wood in phenol in 30–40: 70–60 weight ratios resulted in homogeneous liquefied materials, which were directly used to synthesize phenol–formaldehyde (PF)-type resins. The synthesized resins showed good physical and handling properties: low viscosity, stability for storage and transportation, and resin applicable by a common sprayer. Particleboard panels bonded with the synthesized resins showed promising physical properties and significantly lower formaldehyde emission values than those bonded with the urea–formaldehyde resin control. One deficiency observed for the synthesized resins was lower internal bond values, which might be overcome the use of a hot-stacking procedure. Overall, the process of wood liquefaction with limited amounts of phenol as a solvent was shown to have the potential of providing practical, low-cost PF-type resins with very low formaldehyde emission potentials.

Polyurethane foams and resins

Yao et al. (1996) prepared polyurethane foam with water absorbing property from liquefied starch in PEG and diphenylmethane diisocyanate (MDI) using surface-active agents by open cells method. To obtain the excellent water absorbing properties, it was essential to get a continuous cell structure. Continuous cell structure can be easily obtained by using the surface-active agents for the cell opening and adding a small amount of high-molecular weight triol in formula foam. Foam could absorb water up to 2000 wt % within a few minutes and also showed good water retention properties and significant mechanical properties.

Kurimoto et al. (2000) obtained wood liquefaction using glycerol and PEG-400 in the presence of sulphuric acid. Polyurethane (PU) films were prepared by a solution-casting technique after co-polymerization of the obtained liquefied wood and polymeric methylene diphenyle diisocyanate (PMDI) in dichloromethane. FT-IR spectra, weight loss in acetone, and tensile properties were studied as functions of the isocyanate/hydroxyl group ratio and of wood content in PU film. The increase of wood content at a mentioned ratio of 1.0 significantly enhanced the Young's modulus, and reduced the maximum elongation of liquefied wood-polyurethane film. Lee et al. (2002c) liquefied the waste paper in the presence of polyhydric alcohols for the preparation of biodegradable polyurethane foams, and have researched the thermal stability, biodegradability, and genotoxicity. The obtained foams showed satisfactory density and mechanical properties as those derived from the polyol foam of liquefied wood or starch.

Kunaver et al. (2010b) were performed liquefaction of Central-European softwoods meal using a mixture of diethylene glycol and glycerol and a minor addition of *p*-toluenesulfonic acid as a catalyst. The liquefied wood was then used as a replacement of a certain amount of the polyhydroxy alcohol in the polyester synthesis, enabled by the large number of hydroxyl groups that were available in the liquefied wood. Three different polyesters were synthesized by using adipic acid and phthalic acid anhydride as reagents. The polyesters have hydroxyl values that were reduced due to esterification, from 1043 mg KOH/g of the liquefied wood to 400–800 mg KOH/g. Polyhydroxyl alcohols (22–23 %) in the polyester formulations were replaced by wood derivatives. Such saturated polyesters are suitable for further use in polyurethane foam production.

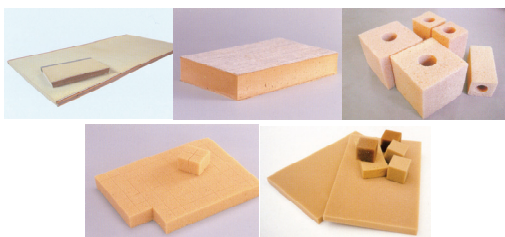

Fig. 4. Products from liquefied wood/polyurethane foams system (www.greentech-fc.co.jp)

Epoxy resins

Epoxy resins are widely used as packaging and insulation materials and adhesives because of their excellent moisture, solvent, and chemical resistance and good adhesion to many substrates. However, they are frequently used with some other materials in commercial applications. Lignin has a highly branched structure consisting of phenyl propane units. The content of phenol hydroxyls in the lignin macromolecules allows the utilization of lignin as a substitute for phenol in the synthesis of an epoxy resin. The introduction of the aromatic structure in lignin into the epoxy resin can enhance the adhesive strength and improve the thermal properties. Several approaches have been taken to incorporate lignin or lignin derivatives into epoxy resins. In the lignin molecules, a large number of the phenol hydroxyls are etherified. Liquefaction can release some of the etherified hydroxyl groups and reduce the molecular weight of lignin. The release of hydroxyl groups can increase the number of reactive groups. The reactivity of lignin can thus be improved (Xie and Chen, 2005).

When liquefied wood reacts with various epoxy compounds, new types of resins are obtained. The cured conditions and properties of obtained products were found. For research diglycidyl ether of ethylene glycol oligomers: tetraethylene glycol diglycidyl ether (TEGDGE), diethylene glycol diglycidyl ether (DEGDGE) and ethylene glycol diglycidyl ether (EGDGE), as well as diglycidyl ether of bisphenol A (DGEBA) were used as a epoxy compounds. The curing reagent was triethylene tetramine (TETA). Under conditions, which were changed, resins were obtained, whose properties increased with amount of liquefied wood. Similar properties were found in resins which were obtained from lignin, instead from wood. There, lignin was used, which was a side-effect from sulphuric procedure of cellulose production. Lignin was not liquefied, but dissolved in 1 % water solution of NaOH at 60 °C, after that it was mixed with epoxy components and curing reagent was added. The above mentioned methods gained a whole range of, so far, unknown properties of different resins and different possibilities of use.

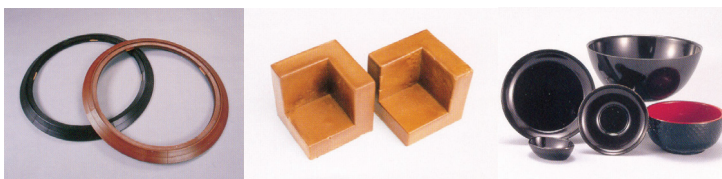

Fig. 5. Products from liquefied wood/epoxy resins system (www.greentech-fc.co.jp)

Kishi et al. (2006) synthesized epoxy resins based on wood. Wood was first liquefied in the presence of resorcinol with or without sulphuric acid as catalyst

at elevated temperature. Based on hydroxyl groups, resorcinol-based liquefied wood is considered a good raw material for synthesizing epoxy wood-based resins. Phenolic OH groups of liquefied wood reacted with epichlorohydrine in alkaline conditions. Epoxy resin functionality is controlled by the concentration of phenolic OH groups in liquefied wood, which was the dominant factor in the network density and flow properties of epoxy resins. The results of bending strength and elastic modulus of obtained highly cross linked wood-based epoxy resins were identical to those of commercially available epoxy resins, diglycidyl ether of bisphenol A (DGEBA). Also, the shear strength of adhesive from wood-based epoxy resin was higher than that of DGEBA when used plywood as a base for gluing. The mechanical properties and adhesive properties show that the epoxy resin-based wood may be suitable for natural resin matrix composites reinforced with plant fibres.

Urea-formaldehyde resins

Antonović (2008) researched the new systems of urea-formaldehyde adhesives modified with liquefied wood for particleboards production. Based on the obtained results, liquefied wood showed that it does not have any polymer or adhesion properties. Regarding that laboratory synthesis of designed liquefied wood-formaldehyde resin (LWF resin) was conducted. Liquefied wood is synthesized with formaldehyde respectively. Due to the polyphenolic properties of lignin in liquefied wood, LWF resin was synthesized analogously to the production of novolac-type of phenol-formaldehyde resin, and was prepared based on the percentage of lignin content in the researched type of wood specie (poplar). The ratio of formaldehyde/phenol was determined in a molar ratio of 0.75/1, in the reactor at 90 °C for 120 min. Prepared LWF resin was used in the modification of urea-formaldehyde resin up to 15 %, and obtained results showed a significant reduction of free formaldehyde emissions, while maintaining good particleboards physical and mechanical properties.

Antonović et al. (2009a, 2009b) explored the influence of experimental pressing parameters on the compatibility of liquefied wood with urea-formaldehyde resins, the influence on polymer structure and adhesion-cohesion properties of modified urea-formaldehyde adhesives and on the physical-mechanical properties and formaldehyde emission of particleboards. The results showed that in all cases of replacement of urea-formaldehyde resin wood with liquefied wood, emission of formaldehyde in particleboards was significantly reduced.

Furthermore, the same authors researched the properties of particleboards produced with catalytic activity of liquefied wood on urea-formaldehyde resin polymerization, and compared them with particleboards that were produced with commercial type of catalyst, such as ammonium chloride and ammonium sulphate. Before use, liquefied wood was not specially prepared, but the highly acidic nature of its components that enables liquefaction was used for resin

polymerization. Results showed that liquefied wood as a catalyst proved to be successful in replacing the classical and commercial types of catalysts. Obtained studies showed that liquefied wood as a catalyst has a positive effect on polymer structure, adhesion-cohesion properties of urea-formaldehyde adhesives, on the physical-mechanical properties and formaldehyde emission of particleboards (Antonović et al., 2010).

Melamine-formaldehyde resins

Kunaver and coworkers (2010a) liquefied different types of southern European hardwoods and softwoods with glycerol/diethylene glycol. The liquefied spruce wood was reacted in a condensation reaction in the hot press with different melamine–formaldehyde and melamine–urea formaldehyde resin precursors and used as adhesives for wood particleboards. The mechanical properties of these particleboards and the determination of formaldehyde release, proved that addition of 50 % of the liquefied wood to such resin precursors caused the product to meet the European standard quality demands for particleboards. They achieved up to 40% reduction of the formaldehyde emission. The temperature of the press unit was lowered from 180 °C to 160 °C with no significant influence on the mechanical properties.

Coatings

Budija et al. (2009a) were used as starting reactants for liquefaction black poplar wood, diethylene glycol (DEG), and sulphuric acid as a catalyst. The liquid mixture obtained by the liquefaction was composed of the real product of the reaction (the so called “excess solvent free liquefied wood” (ESFLW)) and of the remaining unreacted DEG. OH number investigation showed that the ESFLW in the liquid mixture contributes to maximally 60 % of the free -OH groups. The crosslinking of the ESFLW without any curing agents or additives was performed for the first time, and the drying stages investigated. FT-IR investigations demonstrated that the obtained crosslinked polymer film could be an ether and/or ester network.

Budija et al. (2009b) prepared a self-crosslinked coating entirely from liquefied spruce wood, without any curing agents. The liquefied spruce wood was then used as a feedstock to make a self-crosslinked coating. The curing reaction was performed in a laboratory oven (130 °C, 24h). FT-IR spectra of the self-crosslinked films indicated that the film formation process was a chemical reaction. Also, they investigated the surface resistance to cold liquids, flexibility, gloss and wettability by water, and results showed that spruce wood can be liquefied and transformed into a new material by the discovered self-crosslinking ability, and the new material can be used for a surface coating.

Conclusions

This review showed validity for the researches of liquefied wood application in novel types of polymeric materials. When talking about its potential use in the wood industry, attention must be focused on development of different types of resins (phenol- and urea-formaldehyde, polyurethane, resorcinol or isocyanate resins) for wood composite materials production (wood-based panels). Wood composite materials, such as particleboards, plywood, composite panels, OSB, MDF, WPC, HPL and other panel types, are materials of the future. With their wide spectra of potential applications these materials occupy almost all fields of use.

Adhesives for wood composite materials are essential non-wooden components in wood composite production. Based on previous researches presented in this paper, liquefied wood showed potential in resins designed for the wood composite materials production, as partial or complete replacement for synthetic resins.

Furthermore, new kinds of polyurethane and phenolic foams from liquefied wood can be potentially used in the furniture industry, especially in the production of upholstered furniture. Epoxy resins based on liquefied wood, because of their properties, will surely find its place in the wood industry as a moulded product or packaging.

Finally, the present studies indicated unimaginable possibilities of scientific research and development aimed at improving different types of resins derived from liquefied wood, and opened new challenges in the researches of natural, environmentally impeccable materials with unlimited raw resources.

References

- Acemioğlu, B., Alma, M.H. (2002): Kinetics of wood phenolysis in the presence of HCl as catalyst, *J. Appl. Polym. Sci.* 85, 1098-1103.
- Alma, M.H., Yoshioka, M., Shiraishi, N. (1996): The preparation and flow properties of HCl catalyzed phenolated wood and its blends with commercial novolac resin, *Holzforschung* 50, 85-90.
- Alma, M.H., Shiraishi, N. (1998): Preparation of polyurethane-like foams from NaOH-catalyzed liquefied wood, *Holz als Roh- und Werkstoff* 56, 245-246.
- Antonović, A., Kunaver, M., Jambreković, V., Kržan, A., Pervan, S., Ištvanić, J. (2006): Carbamide-formaldehyde adhesive systems modified with liquefied wood. Part I. Acid catalyst method of wood liquefaction with various polyhydric alcohols. In: International Conference Technologies of Wood Processing, Zvolen, Slovakia, 7-14.
- Antonović, A. (2008): Researches of new formaldehyde adhesive systems for wood panels modified with liquefied wood. Dissertation, University of Zagreb, Faculty of Forestry.
- Antonović, A., Jambreković, V., Brezović, M., Pervan, S., Kljak, J., Ištvanić, J., Španić, N. (2009a): New formaldehyde adhesive systems for particleboards modified with liquefied wood. In: Forest, Wildlife and Wood Sciences for Society Development, Prague, Czech Republic, 16-18.

- Antonović, A., Jambreković, V., Španić, N., Tišler, V., Medved, S. (2009b): Influence of some pressing parameters on properties of particleboards modified with liquefied wood. In: 20th International scientific conference - Wood is good – New materials, quality and design of products, Zagreb, Croatia, 21-31.
- Antonović, A., Jambreković, V., Kljak, J., Španić, N., Medved, S. (2010): Influence of urea-formaldehyde resin modification with liquefied wood on particleboard properties, *Drvna industrija* 61 (1), 5-14.
- Budija, F., Tavzes, Č., Zupančič-Kralj, L., Petrič, M. (2009a): Self crosslinking and film formation ability of liquefied black poplar, *Bioresour. Technol.* 100, 3316-3323.
- Budija, F., Pavlič, M., Petrič, M. (2009b): Characteristics of a self-crosslinked coating made from liquefied spruce wood. In: 20th International scientific conference - Wood is good – New materials, quality and design of products, Zagreb, Croatia, 165-171.
- Fengel, D., Wegener, G. (1989): Wood – Chemistry, Ultrastructure, Reactions. Kessel Verlag, Remagen, pp. 26-65.
- Grbac, I., Bogner, A., Antonović, A., Jambreković, V. (2003): Liquefied wood. In: 5th International Conference: Wood in Construction Industry - Current trends, Zagreb, Croatia, 77-84.
- Hassan, E. B., Kim, M. and Wan, H. (2009): Phenol-formaldehyde-type resins made from phenol-liquefied wood for the bonding of particleboard, *J. Appl. Polym. Sci.* 112, 1436–1443.
- Hon, D.N.-S. (1996): Chemical modification of lignocellulosic materials. Marcel Dekker, New York.
- Honglu, X., Tiejun, S. (2006): Wood liquefaction by ionic liquids, *Holzforschung* 60, 509-512.
- Kishi, H., Fujita, A., Miyazaki, H., Matsuda, S., Murakami, A. (2006): Synthesis of wood-based epoxy resins and their mechanical and adhesive properties, *J. Appl. Polym. Sci.* 102, 2285-2292.
- Kobayashi, M., Asano, T., Kajiyama, M., Tomita, B. (2005): Effect of ozone treatment of wood on its liquefaction, *J. Wood Sci.* 51, 348-356.
- Kobayashi, M.; Hatano, Y.; Tomita, B. (2001): Viscoelastic properties of liquefied wood/epoxy resin and its bond strength, *Holzforschung* 55, 667-671.
- Kobayashi, M., Tukamoto, K., Tomita, B. (2000): Application of liquefied wood to a new resin system – synthesis and properties of liquefied wood/epoxy resins, *Holzforschung* 54, 93-97.
- Kržan, A., Kunaver, M. (2006): Microwave heating in wood liquefaction, *J. Appl. Polym. Sci.* 101, 1051-1056.
- Kunaver, M., Medved, S., Čuk, N., Jasiukaitytė, E., Poljanšek, I., Strnad, T. (2010a): Application of liquefied wood as a new particle board adhesive system, *Bioresour. Technol.* 101, 1361-1368.
- Kunaver, M., Jasiukaityte, E., Čuk, N., Guthrie, J. T. (2010b): Liquefaction of wood, synthesis and characterization of liquefied wood polyester derivatives, *J. Appl. Polym. Sci.* 115, 1265–1271.
- Kurimoto, Y., Doi, S., Tamura, Y. (1999): Species effects on wood-liquefaction in polyhydric alcohols, *Holzforschung* 53, 617-622.
- Kurimoto, Y., Takeda, M., Doi, S., Tamura, Y., Ono, H. (2001): Network structures and thermal properties of polyurethane films prepared from liquefied wood, *Bioresour. Technol.* 77, 33-40.

- Kurimoto, Y., Takeda, M., Koizumi, A., Yamauchi, S., Doi, S., Tamura, Y. (2000): Mechanical properties of polyurethane films prepared from liquefied wood with polymeric MDI, *Bioresour. Technol.* 74, 151-157.
- Lee, W.J., Chen, Y.C. (2008): Novolac PF resins prepared from phenol liquefied *Cryptomeria japonica* and used in manufacturing moldings, *Bioresour. Technol.* 99, 7247-7254.
- Lee, W.J., Liu, C.T. (2003): Preparation of liquefied bark-based resol resin and its application to particle board, *J. Appl. Polym. Sci.* 87, 1837-1841.
- Lee, S. H., Ohkita, T. (2003): Rapid wood liquefaction by supercritical phenol, *Wood Sci. Technol.* 37, 29-38.
- Lee, S.H., Teramoto, Y., Shiraishi, N. (2002a): Resol-type phenolic resin from liquefied phenolated wood and its application to phenolic foam, *J. Appl. Polym. Sci.* 84 (3), 468-472.
- Lee, S.H., Teramoto, Y., Shiraishi, N. (2002b): Acid-catalyzed liquefaction of waste paper in the presence of phenol and its application to novolac-type phenolic resin, *J. Appl. Polym. Sci.* 83 (7), 1473-1481.
- Lee, S.-H., Teramoto, Y., Shiraishi, N. (2002c): Biodegradable polyurethane foam from liquefied waste paper and its thermal stability, biodegradability and genotoxicity, *J. Appl. Polym. Sci.* 83, 1482-1489.
- Lin, L., Yao, Y., Yoshioka, M., Shiraishi, N. (1997): Liquefaction mechanism of lignin in the presence of phenol at elevated temperature without catalysts. Studies on β -O-4 lignin model compound. I. Structural characterization of the reaction products, *Holzforschung* 51, 316-324.
- Mun, S.P., Hassan, E.B.M., Yoon, T.H. (2001): Evaluation of organic sulfuric acids as catalyst during cellulose liquefaction using ethylene carbonate, *J. Ind. Eng. Chem.* 7, 430-434.
- Nonaka, Y.; Tomita, B.; Hatano, Y. (1997): Synthesis of lignin/epoxy resins in aqueous systems and their properties, *Holzforschung* 51, 183-187.
- Santana, M.A.E., Baumann, M.G.D. (1996): Phenol-formaldehyde plywood adhesive resins prepared with liquefied bark of black wattle (*Acacia Mearnsii*), *J. Wood Chem. and Technol.* 16 (1), 1-19.
- Tišler, V. (2002): Utekočinjen les in njegova uporaba, *Les* 54 (9), 281-284.
- Tohmura, S., Li, G., Qin, T. (2005): Preparation and characterization of wood polyalcohol-based isocyanate adhesives, *J. Appl. Polym. Sci.* 98, 791-795.
- Wei, Y., Cheng, F., Li, H., Yu, J. (2004): Synthesis and properties of polyurethane resins based on liquefied wood, *J. Appl. Polym. Sci.* 92, 351-356.
- Xie, T., Chen, F. (2005): Fast liquefaction of bagasse in ethylene carbonate and preparation of epoxy resin from liquefied product, *J. Appl. Polym. Sci.* 98, 1961-1968.
- Yao, Y., Yoshioka, M., Shiraishi, N. (1996): Water-absorbing polyurethane foams from liquefied starch, *J. Appl. Polym. Sci.* 60, 1939-1949.
- Zhang, Y., Ikeda, A., Hori, N., Takemura, A., Ono, H., Yamada, T. (2006): Characterization of liquefied product from cellulose with phenol in the presence of sulfuric acid, *Bioresour. Technol.* 97, 313-321.

Utjecaj genotipa kukuruza na produkciju DON-a i fumonizina

UDC: 633.15 : 631.527

B. Svitlica^{1*}, J. Ćosić², J. Mesic¹

¹Veleučilište u Požegi, Vukovarska 17, 34000 Požega, Hrvatska

²Poljoprivredni fakultet u Osijeku, Trg Svetog Trojstva 3, 31000 Osijek, Hrvatska

Sažetak

Gospodarski značaj uzgoja kukuruza u svijetu i kod nas je veliki, obzirom na najveći potencijal rodnosti u odnosu na ostale žitarice. Visokorodni linijski hibridi kukuruza imaju visok genetski potencijal rodnosti na čije ostvarenje utječe niz čimbenika, među kojima su i uzročnici bolesti, posebice *Fusarium* vrste. Mnoge vrste roda *Fusarium* imaju sposobnost produciranja različitih mikotoksina, pri čemu jedna *Fusarium* vrsta može sintetizirati različite vrste toksina ili pak različite *Fusarium* vrste mogu sintetizirati istu vrstu mikotoksina. Provedena istraživanja usmjerena su na utvrđivanje količine deoksinivalenola (DON) i ukupnih fumonizina u zrnu kukuruza domaćih i kanadskih genotipova, umjetno zaraženih odabranim visoko patogenim izolatima *Fusarium graminearum* i *Fusarium verticillioides*. Obzirom da je *F. graminearum* najznačajniji producent DON-a, a *F. verticillioides* fumonizina te da količina produciranog toksina može biti pokazatelj osjetljivosti na trulež klipa, utvrdili smo količinu navedenih mikotoksina u zrnu primjenom imunokemijske metode određivanja mikotoksina (ELISA). Od ukupno 288 izolata *Fusarium spp.* izolirane su tri dominantno zastupljene *Fusarium* vrste: *F. graminearum*, *F. verticillioides* i *F. subglutinans*. Prisustvo i jačina simptoma truleži ne mora nužno biti pokazatelj količine produciranih toksina. Našim je istraživanjem utvrđena značajna pozitivna korelacija između indeksa truleži klipa nakon umjetne infekcije izolatom *F. graminearum* odnosno *F. verticillioides* i količine produciranog DON-a odnosno ukupnih fumonizina.

Ključne riječi: genotip, *Fusarium* vrste, mikotoksini, fumonizin, deoksinivalenol

Uvod

Fuzarioze klipa kukuruza osim direktnih šteta (gubitak prinosa) nanose i indirektnu štetu uslijed stvaranja i akumuliranja mikotoksina. Mikotoksini danas predstavljaju značajan problem u ishrani ljudi i životinja, obzirom da se mogu sintetizirati već na polju, ali i tijekom skladištenja žitarica. Bolesti kukuruza čiji su uzročnici gljive iz roda *Fusarium* su najvažnije i ekonomski najznačajnije bolesti kukuruza širom svijeta i kod nas. Prouzrokuju trulež sjemena, palež klijanaca, trulež stabljike i trulež klipa. Diljem svijeta fuzarijske bolesti klipa najčešće uzrokuju *F. graminearum*, *F. verticillioides* i *F. subglutinans* (Burgess, 1981; Marić, 1981; Teich, 1989; Reid i Hamilton, 1997; Munkvold, 2003).

* bsvitlica@vup.hr

Infekcija klipa se najčešće ostvaruje s vrha budući da patogen prodire preko svile i krajem cvjetanja (Sutton i Procter, 1982; Balaž et al., 1995). Zarazu obavljaju askospore oslobođene iz peritecija formiranih na zaraženim biljnim ostacima ili ju obavljaju konidije. Klip je na zarazu najosjetljiviji početkom svilanja dok se starenjem svile osetljivost smanjuje (Reid et al., 1992; Reid et al., 1996). Ukoliko je ovome prethodio duži sušni period, što dovodi do slabljenja vitalnosti biljaka, masovna zaraza klipa je neizbježna (Balaž et al., 1995). U nepovoljnim uvjetima skladištenja (povećana vlažnost i temperatura, nedovoljno provjetranje) bolest se nastavlja razvijati i tijekom čuvanja, pri čemu u zaraženom zrnju dolazi do akumuliranja mikotoksina. Pojava fuzarioza klipa kukuruza izrazito je značajna u Srednjoj i Južnoj Americi te se prema istraživanjima Chulze et al. (1997) postotak zaraženih klipova u Ekvadoru kreće od 30,0 do 100,0 %, a najčešći uzročnici su *F. verticillioides*, *F. proliferatum* i *F. subglutinans*. Mesterházy (1989) navodi da zaraza klipa *Fusarium* vrstama u velikoj mjeri ovisi o klimatskim prilikama tijekom osjetljivih stadija razvoja kukuruza te da je tretiranje fungicidima bezuspješno zbog čega se kao najučinkovitija mjera suzbijanja navodi sjetva otpornih ili barem tolerantnih hibrida. Prema istom autoru krajem 20. stoljeća učinjen je značajan napredak oplemenjivača u stvaranju otpornih hibrida. Količina sintetiziranog toksina u biljkama tijekom uzgoja ovisi o temperaturi, vlazi zraka i količini oborina prije i za vrijeme žetve (Shelby et al., 1994; Thiel et al., 1992) kao i sposobnosti izolata gljive da producira toksin. Visoka koncentracija toksina povezuje se s vrućim i suhim vremenom uz povremena razdoblja visoke vlage. Razvoj fuzarioza mogu poticati i insekti koji oštećuju biljke kao i vlaga od 18 do 23 % tijekom skladištenja kukuruza što doprinosi i boljoj produkciji toksina (Miller, 1999; Bacon i Nelson, 1994). Pascale et al. (2002) navode da je količina toksina značajno veća u zrnima sa simptomima nego u o nima bez simptoma što znači da se unos toksina u organizam konzumenata značajno smanjuje odstranjivanjem pljesnivih zrna. Peraica et al. (2003) navode da je prema procjenama FAO oko 25 % svjetske proizvodnje hrane kontaminirano mikotoksinima.

Fumonizin B1 je najotrovniji mikotoksin iz velike skupine toksina koje sintetiziraju gljive roda *Fusarium*. Najznačajniji producenti ovog toksina su *F. verticillioides* i *F. proliferatum* (Fandohan i sur., 2003).

U područjima umjerene klime, kojoj pripada i Republika Hrvatska FB1 se najčešće nalazi na/u kukuruzu te uzrokuje različite bolesti stoke, a u pokusnih životinja je hepatotoksičan i nefrotoksičan. Nije poznato je li ovaj toksin nefrotoksičan ili hepatotoksičan za ljude, no budući da je njegova koncentracija neobično visoka u kukuruzu povezuje se s izrazito velikom učestalošću tumora jednjaka u nekim dijelovima Afrike (Transkei) gdje je kukuruz osnovna namirnica kao i nastanak primarnih tumora jetre u nekim pokrajinama Kine (Peraica i Domjan, 2006). Deoksinivalenol je mikotoksin koji pripada grupi trihotecena. Ovu grupu mikotoksina osim vrsta roda *Fusarium* sintetiziraju i neke vrste iz rodova *Trichoderma*, *Myrothecium*, *Stachybotrys* i *Trichothecium*. Samo

nekoliko mikotoksina (deoksinivalenol (DON), nivalenol (NIV), diacetoksiscirpenol (DAS), 3-a cetildeoksinivalenol (3-AcDON), 15-acetildeoksinivalenol (15-AcDON), 4-acetilnivalenol (fusarenon-X, Fus-X), HT-2 toksin i T-2 toksin) iz grupe trihotecena kontaminira hranu od kojih se najčešće javlja DON (WHO, 1990).

Obzirom da prisustvo i jačina simptoma truleži klipa ne mora nužno biti pokazatelj količine produciranih toksina cilj istraživanja je bio odrediti količine DON-a i ukupnih fumonizina u zrnu kukuruza domaćih i kanadskih genotipova, umjetno zaraženih odabranim visoko patogenim izolatima *F. graminearum* i *F. verticillioides* te postoji li pozitivna korelacija između indeksa truleži klipa i količine produciranog DON-a odnosno ukupnih fumonizina. Imajući u vidu nemogućnost utjecaja na klimatske prilike, te nedovoljnu učinkovitost agrotehničkih mjera na sprječavanje pojave fuzarioza na kukuruзу, agronomska struka oplemenjivačkim radom nastoji stvoriti visokorodne linijske hibride kukuruza koji pokazuju otpornost na fuzarioze.

Materijal i metode

Zaraza 20 klipova po genotipu i izolatu u 2008. godini obavljena je 10-15 dana nakon svilanja ubadanjem inokuliranih čačkalica u sredinu klipa. Razlike u patogenosti izolata *F. graminearum* i *F. verticillioides* za klipove kukuruza ocijenjene su nakon umjetne zaraze (Slika 1). Umjetna infekcija obavljena je na osam domaćih linija i pet linija koje su u Kanadi ocijenjene kao visoko tolerantne. Ocjenjivanje intenziteta bolesti uslijedilo je nakon berbe (Slika 2) na svakom klipu ocjenama od 1 do 5 (Chelkowski, 1989). Na temelju ocjena izračunava se Indeks truleži klipa (F_i – *Fusarium* ear rot index):

$$F_i = (\Sigma F \times 100) / n,$$

gdje je F ocjena pojave truleži za svaki klip, a n broj ocijenjenih klipova.

Nakon ručnog krunjenja klipova određuje se ukupna masa zrna te se zrna podijele u dvije kategorije (Slika 3): zrna sa simptomima truleži (*Fusarium*-damaged kernels – FDK) i zrna bez simptoma bolesti (Healthy-looking kernels – HLK). Nakon toga određuje se udio FDK (%), a za HLK određuje se postotak zaraženih zrna i njihova klijavost na prosječnom uzorku od 400 zrna (metoda vlažnih komora).

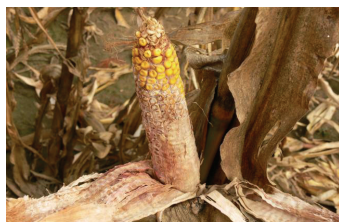

Slika 1. Berba kukuruza nakon umjetne zaraze
Fig. 1. Inoculated maize ear



Slika 2. Skala intenziteta bolesti na klipovima
Fig. 2. Different intensity of maize ear rot



Slika 3. Zrna bez i sa simptomima truleži
Fig. 3. Kernels with and without rot symptoms

Količina DON-a i ukupnih fumonizina u zrnu kukuruza određena je ELISA testom u Laboratoriju kontrole kakvoće robe tvrtke Inspecto d.o.o Đakovo. Prikupljene podatke statistički smo obradili analizom varijance (ANOVA) i LSD testom značajnosti razlika uz pomoć programa Statistica for Windows v. 6,0 i SAS Software procedures PROC MEANS and PROC GLM (SAS Institute Inc., 1999).

Rezultati i rasprava

Indeks truleži klipa u kontrolnoj nezaraženoj varijanti ovisno o liniji kukuruza kretao se od 0 do 30 (Tablica 1). Nakon infekcije izolatom *F. verticillioides* indeks se kretao između 20 (CO 431) i 270 (OS 438-95), a nakon infekcije izolatom *F. graminearum* između 225 (CO 430) i 500 (OS 135-88). Na temelju dobivenih rezultata, a ukoliko uzmemo indeks truleži klipa kao parametar za ocjenu tolerantnosti, možemo reći da je linija OS 135-88 najosjetljivija na ovaj tip bolesti, a linije OS 84-44 i CO 430 najtolerantnije (Slika 4).

Apsolutnu masu (MTZ) smo prikazali kao % od kontrole. Značajno slabiji utjecaj na apsolutnu masu je imao *F. verticillioides*, a smanjenje mase se, ovisno o liniji, kretalo između 1,33 i 18,05 %. Patogenija vrsta *F. graminearum* utjecala je značajnije na smanjenje apsolutne mase koje se kretalo između 6,11 i 72,29 % (Slika 4).

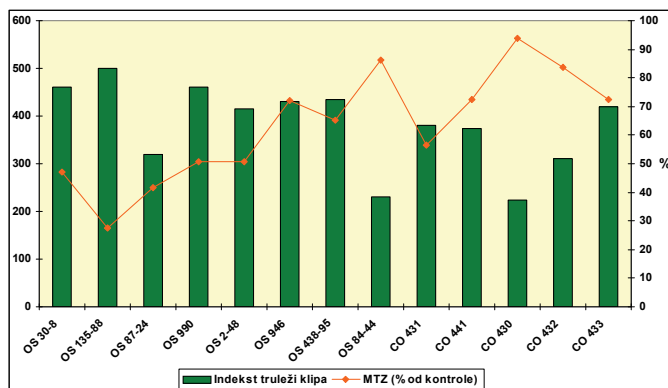

Slika 4. Tolerantnost linija kukuruza na trulež klipa
Fig. 4. Maize inbred line resistance on *Fusarium* ear rot

Između indeksa truleži klipova čiji je uzročnik *F. graminearum* i apsolutne mase zrna utvrđen je visoki negativni koeficijent korelacije ($r = -0,72$).

Nakon infekcije s *F. verticillioides* najmanje sniženje apsolutne mase utvrdili smo kod linije CO433. Apsolutna masa zrna kod linija CO432 i CO431 nije bila statistički značajno niža u odnosu na masu zrna linije CO433. Apsolutna masa zrna linije OS 84-44 bila je statistički značajno niža, a svih ostalih linija statistički vrlo značajno niža u odnosu na liniju CO433.

Nakon infekcije izolatom *F. graminearum* smanjenje apsolutne mase zrna u odnosu na kontrolu kod linije CO430 bilo je statistički vrlo značajno manje u odnosu na sve ostale linije u istraživanju.

Usporedbom tolerantnosti domaćih i kanadskih linija kukuruza na temelju vrijednosti indeksa truleži klipa i apsolutne mase zrna uočavamo da se kao najtolerantnije linije izdvajaju OS 84-44 i CO 430. Postotak zrna sa simptomima truleži prikazan je kao postotak od ukupne mase zrna. U kontrolnoj varijanti taj se postotak kretao od 0 do 2,32. Kod svih linija postotak zrna sa simptomima bio je višestruko manji nakon infekcije izolatom *F. verticillioides* u odnosu na isti postotak nakon infekcije s *F. graminearum* (Tablica 1, Slika 5). Najveći postotak zrna sa simptomima bolesti imala je linija OS 135-88, a najmanji kanadska linija CO 430.

Fusarium vrste uz vrste iz roda *Aspergillus* pripadaju grupi najznačajnijih proizvođača mikotoksina. Obzirom da oni negativno utječu na zdravlje konzumenata te da je *F. graminearum* najznačajniji proizvođač DON-a, a *F. verticillioides* fumonizina te da količina produciranog toksina može biti pokazatelj osjetljivosti na trulež klipa utvrđena je količina navedenih mikotoksina u zrnu. Količina DON-a se ovisno o genotipu kretala između 64,0 (OS 84-44) i 564,0 (OS 2-48) mg/kg zrna. Izolat *F. verticillioides* koji smo koristili za umjetnu infekciju pokazao se kao dobar producent fumonizina te se količina produciranog toksina kretala između

manje od 1 mg/kg (CO 441, CO 432) do 27,4 mg/kg zrna (OS 30-8). Koeficijent korelacije između indeksa truleži klipa i količine produciranog DON-a je bio 0,55, a između indeksa truleži klipa i količine produciranog fumonizina nakon zaraze s *F. verticillioides* 0,40.

Tablica 1. Osjetljivost linija kukuruza na fuzarijsku trulež klipa
Table 1. Maize inbred line resistance on *Fusarium* ear rot

Linija kukuruza	Zrna sa simptomima truleži (% od ukupne mase)	Indeks truleži klipa		MTZ (% od kontrole)	Mikotoksini (mg/kg)	
		Kontrola	Umjetna infekcija		DON	Fumonizini (ukupni)
OS-30-8	2,32	20				
Fvpšenica 5	3,22		120	89,95		27,4
FgSorghum25	50,14		460	47,05	264,0	
OS 135-88	1,42	30				
Fvpšenica 5	3,58		195	81,95		17,0
FgSorghum25	90,00		500	17,71	552,0	
OS 87-24	0	0				
Fvpšenica 5	7,04		150	83,94		7,4
FgSorghum25	61,46		320	41,82	546,0	
OS 990	0	0				
Fvpšenica 5	18,08		235	89,52		3,1
FgSorghum25	66,96		460	50,56	624,0	
OS 2-48	0	0				
Fvpšenica 5	10,69		170	88,76		8,4
FgSorghum25	65,77		415	50,87	564,0	
OS 946	0	0				
Fvpšenica 5	6,93		90	92,55		8,8
FgSorghum25	44,64		430	72,09	306,0	
OS 438-95	1,42	20				
Fvpšenica 5	16,92		270	84,30		16,3
FgSorghum25	78,14		435	65,30	160,0	
OS 84-44	0	0				
Fvpšenica 5	2,27		75	95,19		10,8
FgSorghum25	11,24		230	86,13	64,0	
CO 431	0	0				
Fvpšenica 5	1,35		20	96,89		1,8
FgSorghum25	37,44		380	56,59	198,0	
CO 441	0	0				
Fvpšenica 5	5,44		85	89,99		<1,0
FgSorghum25	24,36		375	72,34	108,0	
CO 430	0	0				
Fvpšenica 5	2,03		60	87,92		3,7
FgSorghum25	16,08		225	93,89	72,0	
CO 432	0	0				
Fvpšenica 5	8,24		140	96,28		<1,0
FgSorghum25	23,05		310	83,71	120	

Linija kukuruza	Zrna sa simptomima truleži (% od ukupne mase)	Indeks truleži klipa		MTZ (% od kontrole)	Mikotoksini (mg/kg)	
		Kontrola	Umjetna infekcija		DON	Fumonizini (ukupni)
CO433	0	0				
Fvpšenica 5	5,60		100	98,67		3,4
FgSorghum25	35,61		420	72,40	180,0	
LSD						
Fvpšenica 5				2,72		
0,05				3,58		
0,01				2,81		
FgSorghum25				3,69		
0,05						
0,01						

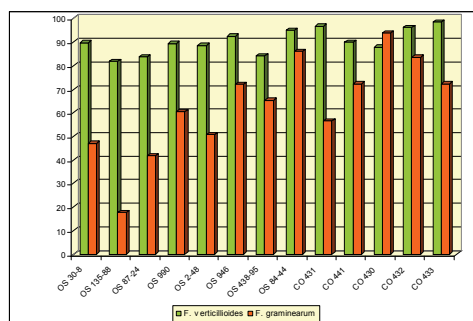

Slika 5. Tolerantnost linija kukuruza na trulež klipa (MTZ kao % od kontrole)

Fig. 5. *F. verticillioides* and *F. graminearum* influence on TKW

Zaključak

Korištenjem najpatogenijih izolata odabranih *Fusarium* vrsta omogućena je pojava jakog intenziteta bolesti, a time i razdvajanje tolerantnih od osjetljivih genotipova. Provedenim istraživanjima utvrđene su razlike u patogenosti i osjetljivosti linija na trulež klipa. Kod 13 ispitanih linija kukuruza indeks bolesti se, nakon zaraze izolatom FgSorghum 25, kretao između 225 i 500, a apsolutna masa je bila manja za 6,11 do 72,29 %. Na fuzarijsku trulež klipa tolerantne su bila domaća linija OS 84-44 i kanadska linija CO 430 kod kojih je indeks truleži klipa nakon infekcije izolatom *F. graminearum* bio 230 odnosno 225, a nakon infekcije izolatom *F. verticillioides* 75 odnosno 60. Apsolutna masa zrna u odnosu na kontrolu, a nakon zaraze s *F. graminearum* je bila manja za 13,87 odnosno 6,11 %. Količina DON-a je ovisila o genotipu i kretala se između 64,0 (OS 84-44) i 564,0 (OS 2-48) mg/kg zrna. Količina produciranih ukupnih fumonizina se kretala između manje od 1 mg/kg (CO 441, CO 432) i 27,4 mg/kg zrna (OS 30-8).

Tijekom istraživanja utvrđena je značajna pozitivna korelacija između indeksa truleži klipa nakon umjetne infekcije izolatom *F. graminearum* odnosno *F. verticillioides* i količine produciranog DON-a odnosno ukupnih fumonizina.

S obzirom da je tolerantnost na akumulaciju toksina u zrnju važan čimbenik pri odabiru linija kukuruza u oplemenjivačkom radu i da postoji pozitivna korelacija između količine akumuliranog toksina i indeksa truleži klipa analize mikotoksina nije nužno provoditi pa se na taj način smanjuju troškovi i povećava brzina rada.

Literatura

- Bacon C.W., Nelson, P.E. (1994): Fumonisin production in corn by toxigenic strains of *Fusarium moniliforme* i *Fusarium proliferatum*, *J. Food Prot.* 57(6), 514 -521
- Balaž, F., Tošić, M., Balaž, J. (1995): Zaštita biljaka, bolesti ratarskih i povrtarskih biljaka. Agencija Krstin, Novi Sad, 1-306.
- Burgess, L.W. (1981): General ecology of the *Fusarium*. 225-2345. In: Nelson, P.E., T.A. Toussoun. R.J. Cook (ed.), *Fusarium: Diseases. Biology, and Taxonomy*. The Pennsylvania State University Press, University Park and London, 457.
- Chelkowski, J. (1989): *Fusarium- Mycotoxins, Taxonomy and Pathogenicity*. Elsevier, Amsterdam – Oxford – New York – Tokyo, 491.
- Chulze, S., Farnochi, M.C., Reynoso, M.M., Ramirez, M.L., Rodriguez, M.I. (1997): *Fusarium* spp. in corn from South America, Sydowia, Special Issue: 208-209.
- Eskola, M. (2002) Study on trichothecenes, zearalenone and ochratoxin A in Finnish cereals: occurrence and analytical techniques, Academic Dissertation, National Veterinary and Food Research Institute (EELA), Department of Chemistry, University of Helsinki, Helsinki.
- Fandohan P., Hell K., Marasas W.H.O., Wingfield M.J. (2003): Infection of maize by *Fusarium* species and contamination with fumonisin in Africa, *African J. of Biotechnol.* 2(12):570-579.
- Marić, A. (1981): *Fusarium* diseases of wheat and corn in Eastern Europe and the Soviet Union. 77-93. Nelson, P.T., T.A. Toussoun, R.J. Cook (ed.), *Fusarium: Diseases, Biology, and Taxonomy*. The Pennsylvania State University Press, University Park and London, 457.
- Mesterhazy, A. (1989): Progress in breeding of wheat and corn genotypes not susceptible to infection by *Fusaria*. In: *Fusarium, mycotoxins, taxonomy and pathogenicity*. Ed.: Chelkowski, J. Elsevier, Amsterdam, 357-386.
- Miller, J.D. (1999): Factors affecting the occurrence of fumonisins in corn. Abstract of papers (p.21) International Conference on the toxicology of Fumonisin, June 28-30, 1999, Arlington, VA.
- Munkvold G.P. (2003): Epidemiology of *Fusarium* diseases and their mycotoxins in maize ears, *Europ. J. of Plant Path.* 109:705-713.
- Pascale M., Visconti A., Pronczuk M., Wisniewska H., Chelkowski J. (2002): Accumulations of fumonisins, beauvericin and fusaproliferin in maize hybrids under field conditions with *Fusarium proliferatum*, *Mycological Research* 106(9):1026-1030.
- Peraica M., Domjan AM. (2006): Mikotoksini i zdravlje ljudi, *Hrvatski časopis za javno zdravstvo* 2(7):1-3.
- Reid, L.M., Bolton, A.T., Hamilton, R.I. Woldemariam, T., Mather, D.E. (1992): Effect of silk age on resistance of maize to *Fusarium graminearum*, *Canadian Journal of Plant Pathology* 14:293-298.
- Reid, L.M., Hamilton, R.I. (1996): Effects of inoculation position, timing, macroconidial concentration, and irrigation on resistance of maize to *Fusarium graminearum* infection through kernels, *Canadian Journal of Plant Pathology* 18, 279-285.

- Reid, L. M., Hamilton R.I. (1997): Breeding maize for ear rot resistance in Canada. *Cereal Res., Commun.* 25,3/2: 639-642.
- Shelby R.A., White, D.G., Bauske, E.M. (1994): Differential fumonisin production in maize hybrids, *Plant Dis.* 78: 582-584.
- Sutton, J.C., Procter, R. (1982): Dispersion analysis of *Gibberella* ear rot in maize, *Canadian Journal of Plant Pathology* 4, 254-258.
- Teich, A.H. (1989): Epidemiology of corn (*Zea mays* L.) ear rot caused by *Fusarium* spp. 319-328. Chelkowski, J. (ed.), *Fusarium* Mycotoxins, Taxonomy and Oathogenicity. Elsevier, Amsterdam- Oxford-New York-Tokyo, 492.
- Thiel, P.G., Marasas, W.F.O., Sydenham, E.W. , Shephard, G.S., Gelderblom, W.C.A. (1992): The implications of naturally occurring levels of fumonisins in corn for human and animal health, *Mycopathologia* 117,3-9.
- WHO (1990) Environmental health criteria 105, Selected mycotoxins. <http://www.inchem.org/documents/ehc/ehc/ehc105.htm>

Influence of maize genotypes on the production of DON-a and fumonisin

B. Svitlica¹, J. Ćosić², J. Mesić¹

¹*Polytechnic of Pozega, Vukovarska 17, 34000 Požega, Croatia*

²*Faculty of Agriculture in Osijek, Trg Svetog Trojstva 3, 31000 Osijek, Croatia*

Summary

The economic importance of maize production is huge all over the world as well as in Croatia. The reason is the largest yield potential compared to other cereals. Many maize lines have a high genetic yield potential that are under an influence of a number of factors, including the disease agents, especially *Fusarium* species. Many *Fusarium* species are capable of producing different mycotoxins. One *Fusarium* species can synthesize different types of toxins and different *Fusarium* species can synthesize the same type of mycotoxin. The conducted research in this paper is focused on the quantity determination of deoxynivalenol (DON) and on the total fumonisin amount in the maize grain of domestic and Canadian genotypes, artificially infected with selected highly pathogenic isolates of *Fusarium graminearum* and *Fusarium verticillioides*. Taking into account that *F. graminearum* is the most important producer of DON and the *F. verticillioides* is the most important producer of fumonisin and that the amount of produced toxins can be an indicator of the susceptibility to the cob maize rot, we determined the amount of those mycotoxins in the grains by using immunochemical methods of the determination of mycotoxins (ELISA). From a total of 288 isolates of *Fusarium* spp. three dominant *Fusarium* species were isolated: *F. graminearum*, *F. verticillioides* and *F. subglutinans*. The presence and the intensity of symptoms of rot is not necessarily an indicator of toxin production. Our study has identified a significant positive correlation between the index of the cob maize rot infection after artificial infection with *F. graminearum* and *F. verticillioides* and quantity of produced DON and total fumonisins.

Keywords: genotype, *Fusarium* species, mycotoxins, fumonizin, deoxynivalenol

Effect of natural zeolite on total nitrogen concentration in pig slurry

UDC: 631.862 : 636.4

A. Špehar^{1*}, M. Ostović², D. Milić³, S. Kalambura⁴

¹*Agroproteinka, Ltd., Strojarska cesta 11, 10361 Sesvetski Kraljevec, Croatia*

²*University of Zagreb, Faculty of Veterinary Medicine, Heinzelova 55, 10000 Zagreb, Croatia*

³*Dubravica Pig-Breeding Farm, Ltd., Pavla Štoosa 109, 10293 Dubravica, Croatia*

⁴*University of Applied Sciences Velika Gorica, Zagrebačka cesta 5, 10410 Velika Gorica, Croatia*

Summary

The aim of the study was to evaluate the effect of natural zeolites on total nitrogen concentration in pig slurry. The study was carried out in an intensive pig farm in 3 equal fattening units during final 2 months of the pig fattening. Unit 1 served as a control. In unit 2 the commercial preparation, a natural zeolite, was added at the animal feed mix. In unit 3 the commercial preparation, the natural zeolite, was daily uniformly spread over the partially slatted floor of the fattening unit. Slurry samples were collected every 10th day during the investigated period. The total nitrogen concentration was analyzed using standard laboratory method. Study results demonstrated the total nitrogen concentration to be lower in both experimental units as compared with the control unit. The total nitrogen concentration was also lower in the unit 3 treated with the slurry additive in relation with the unit 2 with the feed additive treatment.

Keywords: zeolite, slurry, total nitrogen, fattening pigs

Introduction

The structure of pig production has changed considerably in the last five decades. Highly integrated farms have largely disappeared, replaced by intensive systems using confined rearing methods. Management of the large volumes of excreta produced from these systems has meant bedding is minimized and slatted floors are employed, allowing feces and urine to collect as slurry containing approximately 3 to 12 % solids. As intensive farming methods have proven economically effective, many adverse effects of handling livestock wastes have become evident (McCrary and Hobbs, 2001) and the slurry disposal is one of the most significant problems.

Besides other nutrients, the pig slurry is characterized by high levels of nitrogen. The nitrogen is a valuable plant nutrient source, but in excess, can be environmentally dangerous, because of water pollution by nitrate and air

* ana@agroproteinka.hr

pollution by gaseous ammonia emissions (Dourmad et al., 1999). Consequently, there is ever increasing attempt to reduce the nitrogen in the slurry by the use of various additives.

The aim of the study was to evaluate the effect of natural zeolites, feed and slurry additives, on total nitrogen concentration in the pig slurry.

Materials and Methods

The study was carried out in intensive pig farm in 3 equal fattening units, each with 350 animals on an average, during final 2 months of the pig fattening period. Unit 1 served as a control. In unit 2 the commercial preparation, a natural zeolite, with 80 % of clinoptilolite, was added at the animal feed mix at an amount of 3 % by weight. In unit 3 the commercial preparation, a natural zeolite, also with 80 % of clinoptilolite, was daily uniformly spread over the partially slatted floor of the fattening unit in a dose of 0.4 kg/m². Slurry samples were collected every 10th day during the investigated period. The total nitrogen concentration for wastewater quality assessment was analyzed on an HACH LANGE DR 2800 Spectrophotometer.

Results and Discussion

Nitrogen can be present in manure as ammonium-N, organic-N, and nitrate-N. A large portion of the nitrogen in the pig slurry is in the ammonium (NH₄⁺) form. Ammonium (NH₄⁺) and ammonia (NH₃) can interchange rapidly depending on the pH. Ammonium will covert to ammonia at a pH that is greater than 6.5. Increasing the pH increases the amount of ammonia and decreases the amount of ammonium. Organic-N is the most abundant form of nitrogen in animal manure with high solids content (10 % total solids or more). Nitrate-N is present in a small amount (Chastain et al., 1999).

In this study the effect of natural zeolites, the feed and slurry additives, on the total nitrogen concentration in the pig slurry was assessed. Results are presented in Table 1.

Table 1. Average concentration of total nitrogen in pig slurry after zeolite addition

Parameter	Control	Zeolite	
		Feed additive	Slurry additive
Total nitrogen (mg/l)	1975	1690	1500

n=6 per measurement in each unit

Natural zeolites are three-dimensional, microporous, hydrated aluminosilicates minerals with high internal surface area and high cation exchange capacities. There are more than 50 different types of natural zeolites differing in their selectivity towards various cations (Milić et al., 2005).

Clinoptilolite is the most widely used natural zeolite in animal studies due to its structural stability under high temperatures and acidic conditions (Tiwari, 2007). Its chemical formula is $(\text{Na}_4\text{K}_4)(\text{Al}_8\text{Si}_{40})\text{O}_{96}\cdot 24\text{H}_2\text{O}$. The clinoptilolite has a framework structure consisting of four- and five-tetrahedral ring channels that form ion sieve channels. Channel diameters are within interval 3-8 Å. Porosity of clinoptilolite is about 34 %. Its cation exchange capacity is caused when silica (Si^{4+}) is substituted by aluminum (Al^{3+}), thereby raising a negative charge of the mineral lattice. This negative charge is balanced by cations such as sodium, calcium, and potassium, which are exchangeable with other cations (Hedström, 2001).

According to the results the total nitrogen concentration was lower in both experimental units after zeolite addition as compared with the control unit. The total nitrogen concentration was also lower in the unit 3 treated with the slurry additive in relation with the unit 2 with the feed additive treatment. The total nitrogen reduction in this study is in accordance with the results of the study where the zeolite was added to the slurry *in vitro* conditions (Venglovský et al., 1999).

Conclusions

The use of the natural zeolites, the feed and the slurry additives, resulted in reduced total nitrogen concentration in the pig slurry. Moreover, the slurry additive was more effective.

References

- Chastain, J.P., Camberato, J.J., Albrecht, J.E., Adams, J. (1999): Swine manure production and nutrient content. In: South Carolina Confined Animal Manure Managers Certification Program, Clemson University, SC, USA, pp. 1-17 (Chapter 3).
- Dourmad, J.Y., Sève, B., Latimier, P., Boisen, S., Fernández, J., van der Peet-Schwering, C., Jongbloed, A.W. (1999): Nitrogen consumption, utilisation and losses in pig production in France, The Netherlands and Denmark, *Livest. Prod. Sci.* 58 (3), 261-264.
- Hedström, J. (2001): Ion exchange of ammonium in zeolites: a literature review, *J. Environ. Eng.* 127 (8), 673-681.
- McCrary, D.F., Hobbs, P.J. (2001): Additives to reduce ammonia and odor emissions from livestock wastes: a review, *J. Environ. Qual.* 30 (2), 345-355.
- Milić, D., Tofant, A., Vučemilo, M., Venglovský, J., Ondrašovičevá, O. (2005): The performance of natural zeolite as a feed additive in reducing aerial ammonia and slurry ammonium ion concentration in the pig farm nursery, *Folia Vet.* 49 (3), Suppl., 23-25.
- Tiwari, J. (2007): Zeolite as natural feed additives to reduce environmental impacts of swine manure. Available at http://digitool.library.mcgill.ca/webclient/StreamGate?folder_id=0&dvs=1283161245054~627.
- Venglovský, J., Pačajová, Z., Sasáková, N., Vučemilo, M., Tofant, A. (1999): Adsorption properties of natural zeolite and bentonite in pig slurry from the microbiological point of view, *Vet. Med.-Czech* 44 (11), 339-344.

Zbrinjavanje i obrada otpadnih voda grada Vinkovaca

UDC: 628.31 (497.544 Vinkovci)

Z. Kuveždić¹, S. Radojević Lacković¹, M. Habuda-Stanić^{2*}

¹Vinkovački vodovod i kanalizacija d.o.o., K. Žanića 47a, 32000 Vinkovci, Hrvatska

²Sveučilište Josipa Jurja Strossmayera u Osijeku, Prehrambeno-tehnološki fakultet Osijek, Franje Kuhača 20, 31000 Osijek, Hrvatska

Sažetak

Globalizacija, industrijalizacija i rast populacije uzrokuje značajno smanjenje zaliha čiste vode na Zemlji, stoga sve više znanstvenika i stručnjaka nastoje učiniti pojedine industrijske procese što manje štetnima za okoliš, a što često podrazumijeva smanjenje utroška vode u procesu proizvodnje po jedinici proizvoda i primjenu suvremenih tehnoloških rješenja obrade i zbrinjavanja otpadnih voda. Osim industrije, značajne količine otpadnih voda stvaraju i naselja, pri čemu se fizikalna, kemijska i biološka svojstva upotrijebljene vode mijenjaju i bez prerade se ne mogu ponovo koristiti niti ispuštati u okoliš. U postupku pristupanja Republike Hrvatske Europskoj uniji, jedno od najznačajnijih i najskupljih područja usklađivanja zakonodavstva je upravo područje zaštite okoliša, pri čemu se značajan dio odnosi upravo na regulativu vezanu za obradu i zbrinjavanje otpadnih voda. Sustavna odvodnja i izgradnja kanalizacijske mreže u Vinkovcima započela je davne 1957. godine, a tijekom 2005. godine dovršen je novi pogon s ciljem obrade komunalne otpadne vode prije ispuštanja istih u prirodni recipijent - rijeku Bosut. Ovaj rad dati će detaljan prikaz procesa obrade otpadne vode, dok će analiza najznačajnijih parametara prikazati učinkovitost samog procesa obrade otpadne vode grada Vinkovaca.

Ključne riječi: otpadna voda, postupci obrade otpadne vode, Vinkovci

Uvod

Otpadna energija i otpadne tvari nastaju u različitim postupcima čovjekovih djelatnosti, a za samog korisnika predstavljaju nekoristan i nepoželjan otpad koji se može pojaviti u tekućem, krutom i plinovitom obliku. Otpadne tvari koje se pojavljuju u tekućem obliku nazivaju se *otpadnim vodama*. Prema porijeklu otpadne vode se klasificiraju na kućanske ili sanitarne, industrijske i poljoprivredne otpadne vode (Tedeshi, 1997). Otpadnim vodama upotrijebljenim u industriji i naseljima značajno se mijenjaju fizikalna, kemijska i biološka svojstva te se iste bez prerade ne mogu koristiti, a niti ispustiti u okoliš (Tušar, 2004; Tušar, 2009).

Otpadne vode grada Vinkovaca

Grad Vinkovci ima oko 38000 stanovnika, a prema internim podacima oko 89 % kućanstava u Vinkovcima priključeno je na javni vodoopskrbni sustav. Otpadne

* mirna.habuda-stanic@ptfos.hr

vode koje dospijevaju i koje se obrađuju u pogonu tvrtke Vinkovački vodovod i kanalizacija d.o.o. potječu uglavnom iz kućanstava i javnih institucija, dok je udio industrijskih otpadnih voda značajno manji, a dnevni prosjek iznosi 9650 m³/dan.

Rješavanje odvodnje otpadnih voda u Vinkovcima započelo je gradnjom glavnog kolektora davne 1957. godine prošlog stoljeća. Sva prikupljena otpadna voda odvodi se glavnim kolektorom u jugoistočni dio grada, gdje je na kraju kanalizacijskog sustava na lokaciji Jošine, izgrađen uređaj za pročišćavanje otpadnih voda. Izgradnjom ovoga uređaja grad Vinkovci se uvrstio u urbane sredine koje zadovoljavaju visoke ekološke standarde očuvanja okoliša.

Kanalizacijska mreža Vinkovaca sastoji se od primarne kolektorske i lokalne ulične cijevne mreže i uglavnom pokriva potrebe odvodnje sanitarnih i industrijskih otpadnih voda na aktualnom gradskom području. Otpadne vode u pogon za obradu se dovode kanalizacijskim sustavom koji pokriva oko 80 % područja grada, pri čemu je evidentiran 8601 priključak privatnih kućanstva i 583 priključka poslovnih subjekata. Proces pročišćavanja otpadnih voda grada Vinkovaca u pogonu tvrtke Vinkovački vodovod i kanalizacija d.o.o. sastoji se od dvije faze: a) *mehaničko i biološko pročišćavanje* koje se odvija produženom aeracijom i uklanjanjem spojeva dušika i ugljika te b) *aerobna stabilizacija* aktivnog mulja. Proces obrade otpadne vode završava dehidracijom suvišnog mulja i njegovom stabilizacijom pomoću vapna.

Obradena otpadna voda se ispušta u prirodni recipijent rijeku Bosut. Pogon obrade otpadne vode Vinkovaca je kapaciteta 43000 ekvivalent stanovnika i čini prvu fazu izgaranje, odnosno 67 % ukupno predviđenog kapaciteta od 64000 ekvivalenta stanovnika u drugoj fazi. Druga faza izgradnje uređaja na puni predviđeni kapacitet odvijat će se u skladu s porastom opterećenja i planiranim uvođenjem procesa uklanjanja fosfora. Projektirani hidraulički dotok na uređaju iznosi najviše 700 m³/h, odnosno 9000 m³/dan u sušnom periodu i najviše 1300 m³/h u kišnom periodu, uz zadane parametre *Pravilnikom* o graničnim vrijednostima pokazatelja, opasnih i drugih tvari u otpadnim vodama na ispustu - biološka potrošnja kisika (BPK₅) najviše 25 mgO₂/l i kemijska potrošnja kisika (KPK_{Cr}) najviše 125 mgO₂/l (N.N., 94/08).

Retencijski bazen s ulaznom crpnom stanicom

Obrada otpadne vode u pogonu tvrtke Vinkovački vodovod i kanalizacija d.o.o. započinje dolaskom vode gravitacijskim tokom u prostor crpne stanice odnosno retencijskog bazena. Kapacitet ulazne crpne stanice dimenzioniran je prema protoku u kišnom periodu godine, a ukoliko je dotok otpadne vode veći od kapaciteta crpne stanice, voda se prelijeva u retencijski bazen. U crpnoj stanici nalaze se četiri crpke različitih kapaciteta koje se uključuju ovisno o količini vode koja dolazi u pogon za obradu otpadne vode (Slika 1).



Slika 1. Crpna stanica u pogonu za obradu otpadne vode grada Vinkovaca
Fig. 1. Pumping station in wastewater treatment plant of the Vinkovci town

Mehaničko pročišćavanje

Primarna obrada otpadne vode započinje dobavom vode iz retencijskog bazena putem Venturijeve cijevi u tri kanala predviđena za mehaničko pročišćavanje vode. U dva kanala nalaze se dvije paralelne linije finih rešetki s otvorima od 6 mm, dok je treći kanal snabdjeven grubom rešetkom koja se po potrebi uključuje. Krute tvari, odnosno plutajuće suspendirane i taložive tvari, sakupljene na rešetkama uklanjaju se spiralnim transporterom u kontejnerske spremnike.

Pjeskolov i mastolov

Nakon rešetki, otpadna voda odlazi u aerirani pjeskolov/mastolov gdje se uklanja pijesak iz vode, jer pijesak nepovoljno utječe na proces pročišćavanja mulja. Pijesak sa vodom odlazi u tzv. *klasirer* pijeska (Slika 2) koji vodu vraća na početak procesa, dok se izdvojeni pijesak pumpom vadi iz pjeskolova.



Slika 2. Rešetke i klasirer pijeska
Fig. 2. Bar screens and device for sand removal

Pijesak se potom cijedi i odlaže u kontejnere. U samom pjeskolovu provodi se i aeracija u cilju razdvajanja organskih taloživih i anorganskih tvari. Aeracija također poboljšava isplivavanje ulja i masti iz otpadne vode na površinu, što omogućuje njihovo lakše izdvajanje mastolovom. Izdvojene masti i ulja potom se deponiraju u spremnik za masnoće.

Kontaktne bazene

Sekundarna obrada vinkovačke otpadne vode provodi se u kontaktnim bazenima gdje se mehanički obrađenoj otpadnoj vodi dodaje aktivni mulj s linije za povrat mulja. Homogenizacija se postiže miješanjem, a iz kontaktnog bazena voda obogaćena aktivnim muljem se odvodi na dvije odvojene linije za biološku obradu.

Aeracijski bazeni

Nakon kontaktnog bazena, voda ulazi u aeracijske bazene gdje se iz vode uklanjaju organske tvari i spojevi dušika. Proces uklanjanja spojeva dušika iz otpadne vode temelji se na dvostupanjskom aerobnom postupku – nitrifikaciji u kojem se amonijak oksidira u nitrate preko nitrita. Nitrifikacija se odvija djelovanjem bakterija *Nitrosomonas* sp. i *Nitrobacter* sp. čije djelovanje pospešuje upuhivanje zraka u vodu. Obogaćivanje vode zrakom vrši se pomoću sustava za aeraciju kružno po obodu bazena. Sustav za aeraciju sastoji se od membranskih aeratora i puhalo stlačenog zraka koji osigurava biološke procese nitrifikacije. U svakom bazenu se nalazi i mješač koji osigurava ravnomjernu obradu vode po cijelom volumenu bazena. Nakon nitrifikacije, slijedi anaerobna denitrifikacija, odnosno proces redukcije nitrata u plinoviti dušik. Radi osiguranja optimalnih uvjeta prerade vode u ovoj fazi, u bazenima se neposredno provodi kontinuirano mjerenje količine kisika pomoću sonde uronjenih u bazen (Slika 3).



Slika 3. Aeracijski bazen u pogonu za obradu otpadne vode grada Vinkovaca
Fig. 3. Aeration Plant in wastewater treatment plant of the Vinkovci town

Sekundarni taložnici

Iz aeracijskih bazena otpadna voda s mješavinom aktivnog mulja se transportira u sekundarne taložnike gdje se provodi odvajanje pročišćene otpadne vode od viška aktivnog mulja. Istaloženi mulj se pomoću zgrtača transportira u centralni dio taložnika gdje se nalazi muljni lijevak, a prikupljeni mulj se cijevima odvodi do crpne stanice (Slika 4).



Slika 4. Sekundarni taložnik
Fig. 4. Secondary settlement tank

U crpnoj stanici instalirane su četiri crpke kojima se dio mulja vraća u kontaktni bazen. Višak mulja se posebnim crpkama u crpnoj stanici odvodi na ugušćivanje.

Dehidracija mulja

Višak mulja nakon gravitacijskog ugušćivača odlazi u postrojenje za cijedenje, odnosno dehidraciju mulja. Dehidracija viška mulja provodi se pomoću tlačne preše i filtrom. U cilju boljeg učinka obrade suvišnog mulja, u masu se dodaje kationski polimer, a ukoliko je potrebno prije deponiranja povećati udio suhe tvari u mulju dozira se vapno. Ovako stabilizirani iscijeđeni mulj odlaže se na odlagalište mulja koje se nalazi unutar kompleksa tvrtke, a odloženi mulj na odlagalištu leži najmanje šest mjeseci u cilju njegove stabilizacije i ponovnog korištenja u poljoprivredne svrhe ili odlaganja na gradskom deponiju (Slika 5).



Slika 5. Objekt za dehidraciju i odlaganje mulja
Fig. 5. Plant for dewatering and sludge disposal

U laboratoriju tvrtke Vinkovački vodovod i kanalizacija d.o.o. Vinkovci svakodnevno se provodi analiza osnovnih fizikalnih i kemijskih parametara obrađene otpadne vode prije samog ispusta u okoliš, dok se analiza vode od strane akreditiranog laboratorija (Veterinarski zavod, Vinkovci) provodi jednom mjesečno sukladno Pravilniku o graničnim vrijednostima pokazatelja, opasnih i drugih tvari u otpadnim vodama (N.N., 94/08). *Pravilnik o gospodarenju muljem iz uređaja za pročišćavanje otpadnih voda* kada se mulj koristi u poljoprivredi (N.N., 38/08) nalaže kemijsku analizu otpadnog mulja od strane akreditiranog laboratorija dva puta godišnje, a analizu provodi Eko-laboratorij tvrtke Vodovod-Osijek d.o.o. iz Osijeka.

U Tablici 1 prikazani su rezultati kemijske analize dehidratiziranog mulja iz kolovoza 2010. godine.

Tablica 1. Rezultati kemijske analize dehidratiziranog mulja (kolovoz 2010)

Table 1. Chemical analysis of dewatered sludge (August 2010)

Parametar Parameter	Jedinica Unit	Vrijednost Value	MDK* MPC*
Cd	mg/kg	2,96	5
Cr	mg/kg	48,49	500
Ni	mg/kg	51,28	80
Pb	mg/kg	89,11	500
Cu	mg/kg	451,60	600
Zn	mg/kg	514,50	2000
Fe	mg/kg	7100	-
Mn	mg/kg	236,18	-
2,4,4'-triklorbifenil	mg/kg	ispod granice detekcije below detection limit	0,2
2,2', 5,5' - tetraklorbifenil	mg/kg	0,0044	0,2
2,2',4,5,5'- pentaklorbifenil	mg/kg	ispod granice detekcije below detection limit	0,2
2,2',3,4,5,5'- heksaklorbifenil	mg/kg	ispod granice detekcije below detection limit	0,2
2,2',3,4,4',5,5'- heptaklorbifenil	mg/kg	ispod granice detekcije below detection limit	0,2

N.N., 38/08

Na osnovi dobivenih rezultata ispitivanja količine teških metala, organskih tvari i opasnih tvari, može se zaključiti da ispitivani mulj odgovara zahtjevima

Pravilnika o gospodarenju muljem iz uređaja za pročišćavanje otpadnih voda kada se mulj koristi u poljoprivredi (N.N., 38/08).

U Tablici 2 prikazani su rezultati analize otpadne vode na izlasku iz pogona za obradu otpadne vode grada Vinkovaca.

Tablica 2. Karakteristike pročišćene otpadne vode grada Vinkovci

Table 2. Characteristic of treated wastewater from wastewater treatment plant of the Vinkovci town

Parametar Parameter	Jedinica Unit	Vrijednost Value	MDK* MPC*
Boja		Bez	Bez
Miris		Bez	Bez
Krupne tvari		Bez	Bez
pH vrijednost		6,9 - 7,6	6,5 - 8,0
Kisik	mg/l	7,5 - 10,7	-
BPK ₅	mgO ₂ /l	1,6 - 7,9	25
KPK	mgO ₂ /l	5 - 25	125
Suspendirana tvar	mg/l	3 - 24	35
Ulja i masti	mg/l	0,4 - 2,6	25
Mineralna ulja	mg/l	0	5
Detergenti anionski	mg/l	0,13 - 0,4	1
Detergenti kationski	mg/l	0,0 - 0,06	0,5
Ukupni dušik	mg/l	3,4 - 15	21

N.N., 94/08

Svi ispitivani parametri su u granicama vrijednosti propisanih *Pravilnikom* o graničnim vrijednostima pokazatelja, opasnih i drugih tvari u otpadnim vodama (N.N., 94/08).

Zaključak

Učinak procesa obrade otpadnih voda ponajprije ovisi o vrsti i sastavu otpadne vode, kakvoći i aktivnosti mikrobne biomase u pogonu, vremenu obrade vode, koncentraciji otopljenog kisika te pH vrijednosti vode.

Postupak obrade otpadne vode grada Vinkovaca sastoji se od mehaničke i biološke faze pročišćavanja, pri čemu se postiže zadovoljavajući stupanj pročišćavanja unutar zakonski predviđenih granica kakvoće otpadne vode koja

se ispušta u okoliš. Također, suvišni mulj, koji je produkt procesa svojim kemijskim sastavom odgovara Pravilniku o gospodarenju muljem iz uređaja za pročišćavanje otpadnih voda kada se mulj koristi u poljoprivredi, s obzirom da analize mulja ukazuju na odsutnost teških metala i opasnih tvari.

Literatura

Pravilnik o gospodarenju muljem iz uređaja za pročišćavanje otpadnih voda kada se mulj koristi u poljoprivredi (N.N., 38/08)

Pravilnik o graničnim vrijednostima pokazatelja, opasnih i drugih tvari u otpadnim vodama (N.N., 94/08).

Tedeschi, S. (1997): *Zaštita voda*, Zagreb, Hrvatska; Hrvatsko društvo građevinskih inženjera, pp. 59-70.

Tušar, B. (2004): *Ispuštanje i pročišćavanje otpadne vode*, Zagreb, Croatiaknjiga, pp. 13-62.

Tušar, B. (2009): *Pročišćavanje otpadnih voda*, Zagreb, Kigen, pp. 17-45.

Disposal and treatment of waste water in Vinkovci

Z. Kuveždić¹, S. Radojević Lacković¹, M. Habuda-Stanić²

¹ „Vinkovački vodovod i kanalizacija“ d.o.o., K. Žanića 47a, 32000 Vinkovci, Croatia

²University of Josip Juraj Strossmayer in Osijek, Faculty of Food Technology Osijek, Franje Kuhača 20, 31000 Osijek, Croatia

Summary

Globalization and industrialisation are causing significant reduction of clean water on Earth, so many scientists and experts all over the world trying to make industrial processes less harmful to the environment. Such efforts usually involve the application of modern technology solutions in waste water processing. In addition to industry, significant amounts of wastewater and create settlements, where the physical, chemical and biological properties of these waters significantly changed, and the same, without treatment, can not reuse or discharge into the environment. In the process of Croatian accession to the European Union, one of the most important and most expensive areas of harmonization is just the environment, whereby a significant portion relates to the regulations related to the treatment and disposal of wastewater. Drainage system and construction of sewerage network in the town of Vinkovci began back in 1957th year, and in May 2005 the new plant was completed with the aim of treatment of municipal wastewater before releasing them into natural recipients - Bosut river. The process of wastewater treatment consists of two stages - mechanical and biological treatment. This paper will give a detailed process overview, while the analysis of the most important parameters will show the efficacy of the wastewater treatment process in Vinkovci town.

Keywords: wastewater, primary and secondary treatment processes

Lišajevi – bioindikatori kakvoće zraka u gradu Osijeku

UDC: 504.3.054 : 582.29 (497.5 Osijek)

S. Ozimec^{1*}, M. Sikora², A. Opačak¹, T. Florijančić¹,
Z. Puškadija¹, I. Bošković¹, D. Jelkić¹

¹*Sveučilište Josipa Jurja Strossmayera u Osijeku, Poljoprivredni fakultet, Zavod za lovstvo, ribarstvo i pčelarstvo, Trg Svetog Trojstva 3, 31000 Osijek, Hrvatska*

²*Zavod za javno zdravstvo Osječko-baranjske županije, F. Krežme 1, 31000 Osijek, Hrvatska*

Sažetak

Flora epifitskih lišajeva istraživana je tijekom 2004. i 2005. godine, na sedam lokaliteta u parkovima i drvoredima grada Osijeka. Lišajski materijal sakupljan je s drveća do približne visine 2 m iznad tla. Ukupno je zabilježeno 16 vrsta, svrstanih u 14 rodova liheniziranih gljiva. Najviše su zastupljeni listasti lišajevi (81 %), zatim korasti (13 %) i grmasti (6 %). Lišajevi su zabilježeni na 25 vrsta drveća; najviše na lipi, javoru, bagremu, divljem kestenu, brezi i platani. Prema sastavu lišajske flore i rasprostranjenosti lišajskih vrsta, zrak u gradu Osijeku procijenjen je kao umjereno onečišćen. Znatno manji broj lišajeva, otpornih na onečišćeni zrak, opažen je u drvoredima duž frekventnih gradskih prometnica. Veća zastupljenost grmastih lišajeva zabilježena je u drvoredu uz rijeku Dravu, gdje je slabiji utjecaj prometa, a ekološki uvjeti su povoljniji.

Ključne riječi: lišaj, flora, bioindikator, kakvoća zraka, Osijek

Uvod

Lišajevi su simbiotski organizmi sačinjeni od fungalnog člana (mikobiont) i jednog ili više fotosintetskih članova (fotobiont), koji mogu biti pripadnici 25 rodova zelenih alga ili 15 rodova cijanobakterija (Nash, 2008). Sistematika lišajeva integrirana je u carstvo gljiva (*Fungi*), a odjeljku gljiva mješinariki (*Ascomycota*) pripada 98 % mikobionata. Vegetativno tijelo lišaja čini talus specifične morfologije i anatomije te se prema veličini i izgledu talusa lišajevi tradicionalno dijele u tri skupine: korasti, listasti i grmasti.

Brojna istraživanja potvrdila su osjetljivost lišajeva na prisutnost onečišćujućih tvari u zraku. Za razliku od vaskularnih biljaka, čiji listovi imaju kutikulu kao zapreku između lista i atmosphere, lišajevi su bez kutikule i svu potrebnu vodu, plinove i nutrijente apsorbiraju iz okolnog zraka i akumuliraju ih unutar talusa. Stoga se epifitski lišajevi koji rastu na drveću primjenjuju kao bioindikatori za onečišćenja uzrokovana sumporovim dioksidom (Hawksworth i Rose, 1970), amonijakom (van Herk, 1999) i teškim metalima (Loppi i Pirintsos, 2003).

* sinisa.ozimec@pfos.hr

Procjena kakvoće zraka primjenom lišajeva kao biondikatora temelji se na poznavanju strukture i florističkog sastava zajednica epifitskih lišajeva istraživanog područja. Prvo kartiranje lišajeva u urbanom području proveo je švedski botaničar Johan Rutger Sernander, 1926. godine u Stockholmu. Područje gradskog središta u kojem lišajevi izostaju zbog jako onečišćenog zraka nazvao je lišajskom pustinjom (Nash, 2008).

Materijal i metode

Područje istraživanja

Grad Osijek (45°32'N, 18°44'E), nalazi se u sjeveroistočnoj Hrvatskoj, u donjodravskoj nizini, na nadmorskoj visini od 90 m. Smješten je uz desnu ojeditu terasu rijeke Drave, 22 km od njezina ušća u Dunav. Površina grada Osijeka iznosi 169 km²; a prema popisu iz 2001. godine broji oko 90000 stanovnika. Unutar gradskog područja nalazi se 17 parkova, ukupne površine 394000 m², i brojni ulični drvoredi (Gucunski, 2002). Prema podacima meteorološke postaje Osijek za razdoblje 1971.-2000. klima je umjerenokontinentska, semihumidne oznake. Srednja godišnja temperatura zraka iznosi 11,0 °C; najviša (21,3 °C) je u srpnju, a najniža (-0,2 °C) u siječnju (Zaninović et al., 2008). Godišnje količine oborine iznose 655 mm; maksimum je u lipnju (82 mm), a minimum u veljači (35 mm). Srednji godišnji broj dana sa snijegom je 29 dana. Srednja godišnja relativna vlaga zraka iznosi 77 %. Zimi sibirski anticikloni uvjetuju jake sjeverne i sjeveroistočne vjetrove, koji su suhi i hladni. Tijekom proljeća, ljeta i jesen najčešći je vjetar iz sjeverozapadnog smjera.

Sakupljanje i određivanje lišajskih svojti

Epifitski lišajevi, koji rastu na različitim vrstama drveća u parkovima i drvoredima grada Osijeka, sakupljani su tijekom višekratnih terenskih obilazaka u svibnju 2004. te ožujku, srpnju, kolovozu i rujnu 2005. godine. Odabrano je sedam lokaliteta na uzdužnom potezu u pravcu od zapada prema istoku:

- Lokalitet 1, ulica Bele Bartoka; Kolodvorska ulica; Ulica Josipa Jurja Strossmayera; Gornjodravski obala;
- Lokalitet 2, šetalište Petra Preradovića;
- Lokalitet 3, šetalište kardinala Franje Šepera;
- Lokalitet 4, perivoj Zrinjevac;
- Lokalitet 5, perivoj kralja Tomislava;
- Lokalitet 6, perivoj kralja Petra Krešimira IV.;
- Lokalitet 7, perivoj kraljice Katarine Kosače.

Lišajski materijal sakupljan je sa stabala do visine 2 m iznad tla. Grmasti lišajevi su rukom odvojeni od podloge, dok su pomoću noža odvojeni lisnati i korasti lišajevi. Dio lišajskih svojti određen je na terenu pomoću ručne lupe povećanja 10 x, a za promatranje oblika i vanjskih obilježja lišajskih talusa korištena je binokularna lupa LEICA MZ6 povećanja 6,3-40 x. Za određivanje lišajskih svojti korišteni su priručnici i specijalizirana lihenološka literatura: Orange (1994), Dobson (2000), Brodo et al. (2001). Ekološke značajke lišajske flore s obzirom na osjetljivost, odnosno otpornost na prisutnost onečišćujućih tvari u zraku, određene su prema ljestvici indikatorskih vrijednosti (Ellenberg et al., 1992).

Rezultati i rasprava

Za floru epifitskih lišajeva grada Osijeka utvrđeno je ukupno 16 vrsta, svrstanih u 14 rodova liheniziranih gljiva:

- *Candelariella reflexa* (Nyl.) Lettau
- *Evernia prunastri* (L.) Ach.
- *Flavoparmelia caperata* (L.) Hale
- *Flavoparmelia soledians* (Nyl.) Hale
- *Hypogymnia physodes* (L.) Nyl.
- *Lepraria* sp.
- *Melanelixia fuliginosa* (Duby) O.Blanco et al.
- *Melanohalea elegantula* O.Blanco et al.
- *Melanohalea exasperatula* O.Blanco et al.
- *Parmelia sulcata* Taylor
- *Parmelina tiliacea* (Hoffm.) Hale
- *Physcia adscendens* (Fr.) H.Olivier
- *Physcia caesia* (Hoffm.) Fürnr.
- *Physconia grisea* (Lam.) Poelt
- *Punctelia subrudecta* (Nyl.) Krog
- *Xanthoria parietina* (L.) Th.Fr.

Prema životnom obliku, prevladavaju lišajevi listastog talusa (81 %), zatim slijede korasti (13 %) i grmasti lišajevi (6 %).

Ukupno je zabilježeno 25 podloga na kojima rastu epifitski lišajevi (Slika 1), od kojih su 23 (92 %) listopadno drveće i svega dvije (8 %) četinjače (*Pinus nigra*, *P. strobus*).

U parkovima i drvoredima grada Osijeka najčešće stablo nositelj epifitskih lišajeva je lipa (*Tilia* spp.) za koju je vezano 16 vrsta. Na javoru (*Acer* spp.) je zabilježeno 15 vrsta, a na bagremu (*Robina pseudacacia*) 8 vrsta lišajeva. Po 7 vrsta zabilježeno je na divljem kestenu (*Aesculus hippocastanum*), brezi (*Betula pendula*) i platani (*Platanus hibrida*). Učestalost vrsta u flori epifitskih lišajeva

grada Osijeka prikazuje Slika 2. Vrsta *Physcia adscendens* zabilježena je na 36 % svih vrsta drveća na kojima rastu epifitski lišajevi. Druga po učestalosti (26 %) je *Xanthoria parietina*, a treća je s 12 % vrsta *Punctelia subrudecta*. Grmasti su lišajevi najmanje zastupljeni, *Evernia prunastri*, svega 2 %.

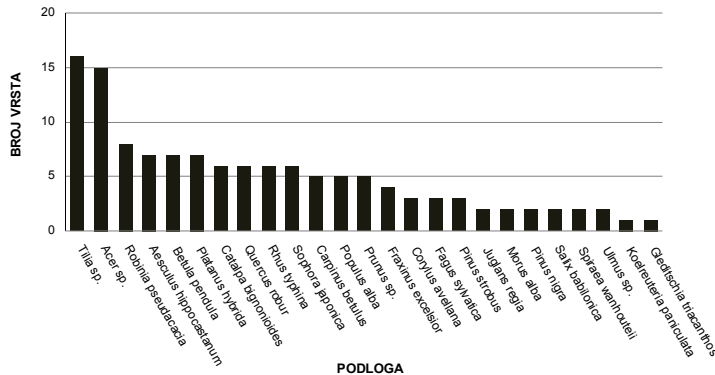

Slika 1. Rasprostranjenost lišajskih vrsta prema vrstama podloge
Fig. 1. Distribution of lichen species according to substrate

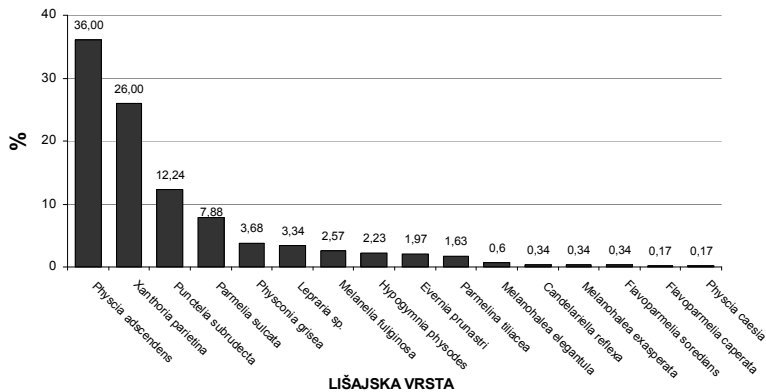

Slika 2. Učestalost epifitskih lišajeva na području grada Osijeka
Fig. 2. Frequency of epiphytic lichens within the City of Osijek area

Analiza indikatorskih vrijednosti za otpornost prema prisutnosti onečišćujućih tvari u zraku pokazuje da 64 % lišajeva pripada skupini umjereno visoke do visoke otpornosti; 29 % vrsta je srednje otporno, a 7 % je lišajeva vrlo visoke otpornosti. Lišajevi iz skupine vrlo niske i niske otpornosti nisu zabilježeni, što

ne znači da je i kakvoća zraka drastično narušena. Ekološki uvjeti u istočnoj Hrvatskoj, primjerice orografija, godišnje količine oborine i humidnost klime, onemogućuju naseljavanje i opstanak tih lišajskih vrsta.

Dugačak drvored sitnolisne lipe (*Tilia cordata*), koji se proteže uz rijeku Dravu šetalištem kardinala Franje Šepera, posjeduje najveću lišajsku raznolikost. Ovdje je zabilježeno najviše listastih lišajeva, kao i brojni talusi grmastog lišaja *Evernia prunastri*. Mikroklimatski uvjeti su vrlo povoljni; česte su pojave rose i magle, a drvored nije zaklonjen pa su lišajevi izloženi svjetlosti potrebnoj fotobiontima za proces fotosinteze. Otvorenost prema sjeveru omogućuje da sjeverni i sjeveroistočni vjetar donosi čestice nutrijenata koje se talože u pukotinama kore. Utjecaj prometa motornih vozila ovdje je neznatan, a blagoj eutrofikaciji zbog unosa dušikovih spojeva i čestica prašine doprinosi intenzivnije kretanje pješaka, biciklista i pasa.

Ispitivanja onečišćenja vanjske atmosfere grada Osijeka kontinuirano se provode od 1972. godine, a stručne poslove praćenja kakvoće zraka na mjernim postajama u mreži grada Osijeka provodi Zavod za javno zdravstvo Osječko-baranjske županije. Sustavna mjerenja provode se i na automatskoj mjernoj postaji Državne mreže za trajno praćenje kakvoće zraka Osijek-1 (križanje Ulice kneza Trpimira i Europske avenije).

Prema podacima s mjerne postaje Osijek-1 (AZO, 2007, 2008, 2009), kakvoća zraka u gradu Osijeku u razdoblju 2006.-2008. godine bila je I. kategorije, odnosno čisti ili neznatno onečišćeni zrak, s obzirom na onečišćujuće tvari SO₂, NO₂ i CO, dok je II. kategorije, umjereno onečišćeni zrak, s obzirom na lebdeće čestice PM₁₀. Usporedni prikaz sumarnih koncentracija onečišćujućih tvari u zraku za razdoblje 2006.-2008. na mjernoj postaji Osijek-1 dat je u Tablici 1.

Tablica 1. Usporedni prikaz sumarnih koncentracija onečišćujućih tvari u zraku za razdoblje 2006.-2008. na mjernoj postaji Osijek-1

Table 1. Comparative data on summarily concentrations of air pollutants for the period 2006-2008 at Osijek-1 measuring station

Godina/Year	2006.		2007.		2008.	
Onečišćujuća tvar/Pollutant	C	C _M	C	C _M	C	C _M
NO ₂ (µg/m ³)	28	78	30	72	24,25	78,24
SO ₂ (µg/m ³)	17	63	11	66	6,67	47,25
CO (mg/m ³)	0,58	2,10	0,53	2,10	0,50	1,93
PM ₁₀ (µg/m ³)	40,9	125,6	35	116	36,75	111,19

C = srednja dnevna koncentracija/C = mean daily concentration;

Tijekom 2008. zabilježeno je 75 dana kada su 24-satne koncentracije lebdećih čestica prekoračile granične vrijednosti (> 50 µg/m³) i 35 dana s prekoračenim tolerantnim vrijednostima (> 65 µg/m³), najčešće u siječnju, veljači, listopadu i studenome. Glavni uzrok narušavanju kakvoće zraka u gradu Osijeku su emisije

ispušnih plinova iz motornih vozila, kojih je tijekom zadnjeg desetljeća sve više na gradskim prometnicama, pa je i intenzitet prometa višestruko povećan. Epifitski lišajevi kao bioindikatori također pokazuju da je zrak u gradu Osijeku opterećen prašinom i povišenim emisijama dušikovih spojeva iz ispušnih plinova motornih vozila. Stoga su stabla u drvoredima uz frekventne gradske prometnice obrasla nitrofilnim lišajevima, među kojima su najčešći: *Candellariela reflexa*, *Physcia adscendens*, *Xanthoria parietina*, vrste koje su vrlo otporne na onečišćujuće tvari u zraku.

Zaključak

Istraživanjem sastava flore epifitskih lišajeva kao bioindikatora kakvoće zraka, utvrđena je umjerena onečišćenost zraka u urbanim cjelinama grada Osijeka.

Literatura

- AZO (2007): Godišnje izvješće o praćenju kakvoće zraka na području Republike Hrvatske za 2006. godinu, Zagreb: Agencija za zaštitu okoliša, pp. 145-146. (www.azo.hr/IZVJESCA02, preuzeto 25. kolovoza 2010.)
- AZO (2008): Godišnje izvješće o praćenju kakvoće zraka na području Republike Hrvatske za 2007. godinu, Zagreb: Agencija za zaštitu okoliša, pp. 177-180. (www.azo.hr/IZVJESCA02, preuzeto 25. kolovoza 2010.)
- AZO (2009): Godišnje izvješće o praćenju kakvoće zraka na području Republike Hrvatske za 2008. godinu, Zagreb: Agencija za zaštitu okoliša, pp. 35-38. (www.azo.hr/IZVJESCA02, preuzeto 25. kolovoza 2010.)
- Brodo, I.M., Sharnoff, S.D., Sharnoff, S. (2001): Lichens of North America, New Haven: Yale University Press, pp. 1-79.
- Dobson, F.S. (2000): Lichens - an illustrated guide to the British and Irish species, Slough: The Richmond Publishing Co. Ltd., pp. 1-431.
- Gucunski, D. (2002): Osječki perivoji i drvoredi, Osijek: Državni arhiv u Osijeku, pp. 1-119.
- Hawksworth, D.L., Rose, F. (1970): Qualitative scale for estimating sulphur dioxide air pollution in England and Wales using epiphytic lichens, *Nature* 227, 145-148.
- Nash III, T.H. (2008): Lichen biology, Cambridge: Cambridge University Press, pp. 1-303.
- Orange, A. (1994): Lichens on trees - a guide to some of the commonest species, Cardiff: National Museum of Wales, pp. 1-48.
- Loppi, S., Pirintsos, S.A. (2003): Epiphytic lichens as sentinels for heavy metal pollution at forest ecosystems (central Italy), *Environ. Pollut.* 121, 327-332.
- Van Herk, C.M. (1999): Mapping of ammonia pollution with epiphytic lichens in the Netherlands, *Lichenologist* 31, 9-20.
- Ellenberg, H., Weber, H.E., Düll, R., Wirth, V., Werner, W., Paulissen, D.: (1992): Zeigerwerte von Pflanzen in Mitteleuropa, *Scripta Geobot.* 18, 215-237.
- Zaninović, K., Gajić-Čapka, M., Perčec-Tadić, M. et al. (2008): Klimatski atlas Hrvatske/Climate atlas of Croatia 1961-1990., 1971-2000., Zagreb: Državni hidrometeorološki zavod, pp. 160-161.

Lichens – bioindicators of air quality in the city of Osijek

S. Ozimec¹, M. Sikora², A. Opačak¹, T. Florijančić¹,
Z. Puškadija¹, I. Bošković¹, D. Jelkić¹

¹*Faculty of Agriculture in Osijek, Department of Wildlife, Fishery and Beekeeping, Trg Svetog Trojstva 3, HR-31000 Osijek, Croatia*

²*Public Health Institute of the Osijek-Baranja County, F. Krežme 1, HR-31000 Osijek, Croatia*

Summary

Epiphytic lichen flora was surveyed in the period 2004-2005, on seven sites in parks and alleys in the City of Osijek. The samples were collected from trees at a height up to 2 m. A total of 16 species, classified into 14 genera of lichenized fungi, were recorded. Foliose lichens dominates (81 %), followed by crustose (13 %) and fruticose lichens (6 %). The lichens were found growing on 25 tree species, and the most on: linden, maple, black locust, horse chestnut, birch, and plane. According to composition of the lichen flora and distribution of species, the air in the City of Osijek is estimated as moderately polluted. Noticeably lower number of lichens was observed in tree alleys along the frequent city roads. Due to intake of dust and increased on-road emissions of nitrogen compounds, the trees are covered by nitrophilous lichens, resistant to higher eutrophication and tolerant to air pollution. More frequent occurrence of fruticose lichens was observed on linden trees in alley along the Drava River, where the traffic impact is lower and ecological conditions more favourable.

Keywords: lichen, flora, bioindicator, air quality, Osijek

Uspješnost uklanjanja arsena oksidacijskim postupcima pri preradi podzemne vode u Vodovodu Osijek

UDC: 628.161.3 : 546.19 (497.543)

Ž. Romić^{1*}, B. Kalajdžić², M. Habuda-Stanić²,
D. Pichler¹, M. Kuleš²

¹VODOVOD-OSIJEK d.o.o., PJ Gradski vodovod, RJ Laboratorij, Poljski put 1, 31000 Osijek, Hrvatska

²Sveučilište Josipa Jurja Strossmayera u Osijeku, Prehrambeno-tehnološki fakultet Osijek, Franje Kuhača 20, 31000 Osijek, Hrvatska

Sažetak

Podzemna voda, koja je izvor pitke vode vodovodnog sustava grada Osijeka, svojim kemijskim sastavom ne zadovoljava standarde zdravstvene ispravnosti vode za piće zbog povišenog sadržaja organskih tvari, željeza, mangana, arsena i amonijaka. Poseban problem u tehnologiji obrade ove podzemne vode je povišena koncentracija arsena. Istraživanja pokazuju da je teško ukloniti trovalentni arsen klasičnim tehnologijama obrade vode, pa se u svrhu djelotvornijeg uklanjanja nameće potreba za oksidacijom izrazito toksičnog As(III) u manje toksičan As(V). Parametri koji kontroliraju pokretljivost arsena su pH i redoks-potencijal (pE). Elektrostatski naboj spojeva As(III) i As(V) značajno utječe na učinak procesa uklanjanja. Cilj ovog rada je izbor najpogodnijeg oksidacijskog postupka u svrhu osiguranja vode za piće odgovarajuće kakvoće. Rezultati ukazuju da oksidacijom osječke podzemne vode s 1,5 mgO₃/l uz dodatak 1,2 mgFe/l, koncentracija ukupnog arsena se smanji za oko 30 %, a koncentracija As(III) za 33 % od početne koncentracije, dok oksidacijom sa 3,0 mgO₃/l uz dodatak 1,2 mg Fe/l, koncentracija ukupnog arsena se smanji za oko 74 %, a koncentracija As(III) za 65 %. Oksidacijom 1 %-tnom otopinom KMnO₄ uz koagulant FeCl₃ uklanja se oko 85 % ukupnog arsena i 93 % arsena(III), dok uz koagulant polialuminij klorid ukupni arsen se uklanja 64 %, a arsen(III) 75 %.

Ključne riječi: podzemna voda, oksidacija, tehnologija obrade vode, uklanjanje arsena

Uvod

Kakvoća podzemnih voda prvenstveno ovisi o hidro-geološkim, hidro-kemijskim i mikrobiološkim značajkama vodonosnika i njegove neposredne krovine odnosno podine. Zbog toga je detaljno poznavanje svih relevantnih čimbenika uvjet pravilnog odabira najpovoljnije metode kondicioniranja podzemnih voda, čija kakvoća ne odgovara predviđenoj namjeni da se upotrijebi kao voda za piće.

* zeljka.romic@vodovod.com

U mnogim zemljama svijeta, kao posljedica geološkog sastava tla, arsen se javlja u visokim koncentracijama u podzemnim vodama koje se koriste kao vode za piće (Slika 1).

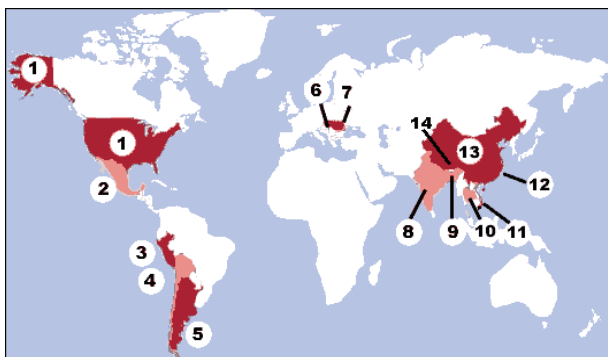

Slika 1. Broj ljudi širom svijeta izloženih trovanju arsenom u vodi za piće
Fig. 1. Number of people around the world exposed to arsenic from drinking water

- (1. USA nepoznato – unknown, 2. Meksiko 400 000, 3. Čile 437 000, 4. Bolivija 20 000, 5. Argentina 2 000 000, 6. Mađarska i Hrvatska 20 000 7. Rumunjska 36 000, 8. Indija 1 000 000. 9. Bangladeš 50 000 000., 10. Tajland nepoznato – unknown, 11. Vijetnam 1 000 000, 12. Tajvan 200 000, 13. Kina 720 000, 14. Nepal nepoznato – unknown)

U sjevernom Čileu koncentracije arsena su u području od 100-1000 $\mu\text{g/l}$, a u jugoistočnoj Aziji (Bangladeš, Indija, Filipini, Tajvan) koncentracije arsena se kreću od 300-3400 $\mu\text{g/l}$ (Eisler, 1988; WHO, 2001).

Voda je jedan od glavnih oblika transporta arsena u okolišu. Njegova pojava u visokim koncentracijama u prirodnim vodama, najčešće je posljedica geološkog sastava tla, odnosno otapanja željeznih oksida i oksidacije arsenovih pirita, ali može biti i posljedica antropološkog djelovanja, odnosno uporabe herbicida i insekticida na bazi spojeva arsena, te nepropisnog odlaganja opasnog otpada teške industrije (Smedley i Kinniburg, 2002). Otapanje 245 različitih minerala, koji u svom sastavu imaju i arsen, najčešći je put njegovog unosa u podzemne vode.

Arsen je vrlo rasprostranjen u okolišu. U prirodi se javlja u četiri oksidacijska stanja kao arsin (-3), arsen (0), arsenit (+3) i arsenat (+5). U vodenim otopinama egzistira u dva oksidacijska stanja: kao trovalentni arsen u obliku arsenitne kiseline odnosno peterovalentni arsen u obliku arsenatne kiseline (Pongratz, 1998).

Brojnim je istraživanjima utvrđeno da je vrlo teško ukloniti trovalentni arsen klasičnim tehnologijama obrade vode, pa se u svrhu djelotvornijeg uklanjanja arsena iz vode često provodi oksidacija izrazito toksičnog As(III) u manje toksičan As(V). Za oksidaciju arsenita u arsenat primjenjuje se ozon, kisik, klor, kalij-permanganat i vodikov peroksid/ Fe^{2+} (Fentonov reagens).

Materijali i metode

Određivanje koncentracije ukupnog i trovalentnog arsena provedeno je anodnom stripping voltometrijskom tehnikom (ASV) (Kopanica i Novotny, 1998; Application Bulletin 226/2 e, 2003). Koncentracija arsena određivana je u 10 ml uzorka zakiseljenog sa 10 ml 30 % HCl, dok je za detekciju As(III) uz 30 % HCl korištena 1 % askorbinska kiselina (100 µl/10 ml uzorka). Za mjerenje je korišten elektrokemijski instrument *Methrom 757 VA Computrace* s bočno postavljenom rotirajućom zlatnom elektrodom.

Za određivanje pH vrijednosti korišten je pH metar *Metller Toledo*, Seven easy sa elektrodom InLab 413. Kalibracija je vršena dnevno, puferima pH 4,01, pH 7,00 i pH 9,21 (*Metller Toledo*).

Koncentracija ukupnog željeza je mjerena spektrofotometrijski pri 510 nm (UV/VIS spektrofotometar Lambda 20, Perkin Elmer) koristeći Ferower reagens (metoda DR/2000 Handbook, 2000). Provjera rada je vršena dnevno sa standardom željeza koncentracije 10 µg i 100 µg Fe/l (*Fluka*).

Koncentracija dvovalentnog željeza određivana je spektrofotometrijski na 510 nm uz korištenje reagensa Ferower 2 koji stvara narančasto obojenje proporcionalno koncentraciji Fe²⁺ na spektrofotometru proizvođača *Hach*, model DR/2000.

PAN metoda (DR/2000 Handbook, 2000) uz dodatak askorbinske kiseline, alkalnog cijanida i 0,1 % PAN reagensa koristila se za određivanje mangana. Mjerenja su rađena pri 560 nm na aparatu UV/VIS spektrofotometar Lambda 20, Perkin Elmer. Provjera metode je vršena dnevno sa standardom mangana koncentracije 50 µg Mn/l (Carlo Erba).

Za mjerenje mutnoće uzoraka korišten je turbidimetar (2100 P, Hach). Provjera rada turbidimetra vršena je dnevno sa standardom za mutnoću 5,34° NTU (Test kit Hach, Cat.No. 24641-05).

Boja uzoraka određivana je na laboratorijskom spektrofotometru proizvođača *Hach*, model DR/2000 primjenom platina-kobalt metode na 455 nm. Očitane vrijednosti iskazane su stupnjevima Pt-Co skale, a provjera aparata je vršena dnevno pripremljenim standardima od 10 i 30° Pt-Co skale.

Koncentracija ozona u kapljevitoj fazi određivana je sondom za mjerenje otopljenog ozona i indigo metodom (spektrofotometrijski). Korištena je sonda za mjerno područje 0-2 mg/l mjerne osjetljivosti 0,02 mg/l model Dulcotest OZE, *Prominent*.

Indigo metoda podrazumijeva da ozon u kiseloj sredini razgrađuje indigo, smanjujući s obzirom na prisutnu koncentraciju karakteristično obojenje. Prati se promjena apsorbancije kod $\lambda = 600$ nm. Za određivanje sadržaja otopljenog ozona indigo metodom koristio se spektrofotometar proizvođača *Hach*, model DR/2000, metoda Acu Vac DR/2000 Handbook.

Rezultati i rasprava

Pilot ispitivanja oksidacije ozonom u Pogonu za proizvodnju vode

Za potrebe praćenja oksidacije arsena ozonom u Pogonu za proizvodnju vode za piće postavljeno je pilot-postrojenje. Ispitivanja oksidacije s ozonom u ovom slučaju provedena su na već obrađenoj, filtriranoj vodi.

Koncentracija ozona bila je 1,5 mgO₃/l za prvo ispitivanje te 3,0 mgO₃/l za drugo uz dodatak 1,2 mgFe/l u oba slučaja.

Početna vrijednost koncentracije ukupnog arsena iznosila je 37,5 µg As/l, a As (III) 17,5 µg /l. Boja vode iznosila je 15,3° Pt Co-skale, mutnoća 0,26° NTU, a pH vrijednost 7,48.

Pregledom rezultata oksidacije ozonom provedene na pilot postrojenju u Pogonu za proizvodnju vode za piće pri koncentracijama od 1,5 mg O₃/l odnosno 3,0 mg O₃/l uočava se bitna razlika u uspješnosti oksidacije i smanjenja parametra boje vode.

Nakon oksidacije vode ozonom koncentracije 1,5 mg O₃/l, koncentracija ukupnog arsena smanjila se na 26 µg As/l, a koncentracija As(III) na 12,5 µg As/l (Slika 2). Ujedno se uočava da je došlo do povećanja mutnoće vode na 0,365° NTU te neznatnog smanjenja boje vode i pH vrijednosti.

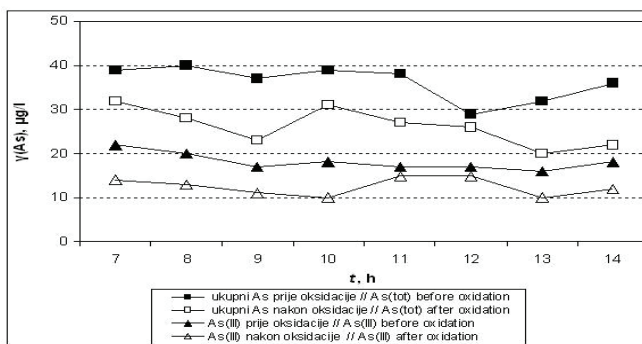

Slika 2. Koncentracija arsena prije i nakon oksidacije s 1,5 mg O₃/l (uz dodatak 1,2 mg Fe/l)
Fig. 2. Arsenic concentration before and after oxidation with 1.5 mg O₃/l (1.2 mg Fe/l added)

Pri oksidaciji s 3,0 mgO₃/l koncentracija ukupnog arsena se smanjila na 9,8 µg As/l, a koncentracija As(III) na srednju vrijednost od 6,3 µg As/l (Slika 3).

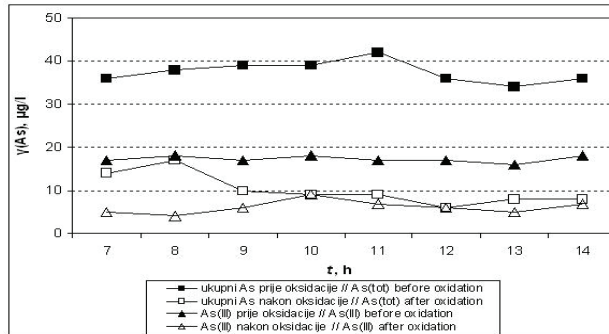

Slika 3. Koncentracija arsena prije i nakon oksidacije s 3,0 mg O₃/l (uz dodatak 1,2 mg Fe/l)
Fig. 3. Arsenic concentration before and after oxidation with 3.0 mg O₃/l (1.2 mg Fe/l added)

Oksidacija ozonom utjecala je na poboljšanje boje vode i srednja vrijednost je iznosila 9,8° Pt Co-skale, ali je došlo do 100 %-tnog povećanja mutnoće boje vode na 0,582° NTU. pH vrijednosti nisu se značajnije mijenjale.

Oksidacijom sa 1,5 mg O₃/l, koncentracija ukupnog arsena se smanji za oko 30 %, a koncentracija As(III) za 33 %, dok oksidacijom s 3,0 mgO₃/l, koncentracija ukupnog arsena se smanji za oko 74 %, a koncentracija As(III) za 65 %.

Očito je da ozon oksidira As(III) u As(V) i u toj se formi kod uobičajenih pH vrijednosti lakše adsorbira na nastale flokule željezovog hidroksida. Dakle pretpostavivši da je primjenom nekog oksidansa sav trovalentni arsen prešao u peterovalentni, uspješnost procesa uklanjanja isključivo ovisi o sadržaju koagulanata koji se dodaje u vodu. Pojedini su autori pratili uspješnost oksidacije arsena s ozonom te došli do zaključka da je ozon je vrlo učinkovit u oksidaciji As(III), a potpuna oksidacija u nekim slučajevima postignuta je za manje od 15 sekundi. Također je uočeno da učinak oksidacije As(III) opada u slučaju kad su u vodi otopljeni mangan, željezo i sulfidi (Kim i Nriagu, 2000).

Ozonizacija je uzrokovala smanjenje vrijednosti pokazatelja boje vode jer dolazi do oksidacije organskih tvari koje uzrokuju pojavu boje i neugodnog okusa i mirisa vode. Nastali oksidacijski nusprodukti su polarne organske molekule koje se zatim veoma lako apsorbiraju na precipitiranim flokulama koagulanata i na taj način uklanjaju iz vode.

Pilot ispitivanja u Pogonu za proizvodnju vode za piće oksidacijom otopinom KMnO₄ uz koagulanate FeCl₃ i PAC

Pilot ispitivanja provedena su u Pogonu za proizvodnju vode za piće uz oksidaciju 1 %-tnom otopinom KMnO₄ uz korištenje različitih koagulanata. Za koagulaciju su korišteni željezo(III) klorid i polialuminij klorid (PAC).

U zbirnom uzorku neprerađene podzemne vode koncentracija ukupnog arsena iznosila je 243,7 $\mu\text{g As/l}$, a koncentracija As(III) 212,6 $\mu\text{g /l}$.

Prosječna vrijednost koncentracije ukupnog arsena na pilot liniji gdje se obrada provodila uz koagulant FeCl_3 , a bez oksidacije iznosila je 81,021 $\mu\text{g As/l}$, dok je na liniji s oksidacijom iznosila 33,86 $\mu\text{g As/l}$ (Slika 4).

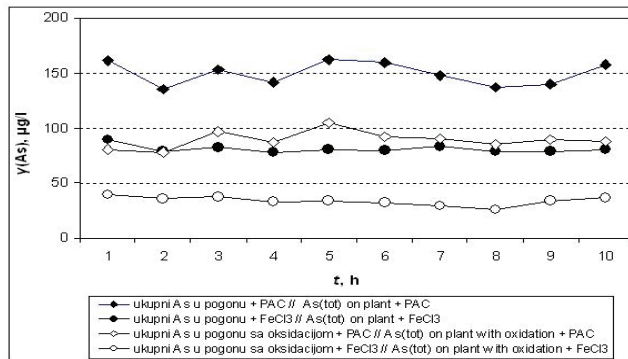

Slika 4. Koncentracija ukupnog arsena nakon obrade s FeCl_3 i PAC bez i s oksidacijom s 1 %-tnom otopinom KMnO_4
Fig. 4. Total arsenic concentration after treatment with FeCl_3 and PAC without and with oxidation using 1 % KMnO_4 solution

Prosječna koncentracija arsena(III) na istoj pilot liniji bez oksidacije iznosila je 59,53 dok je nakon oksidacije koncentracija iznosila 13,74 $\mu\text{g As/l}$ (Slika 5).

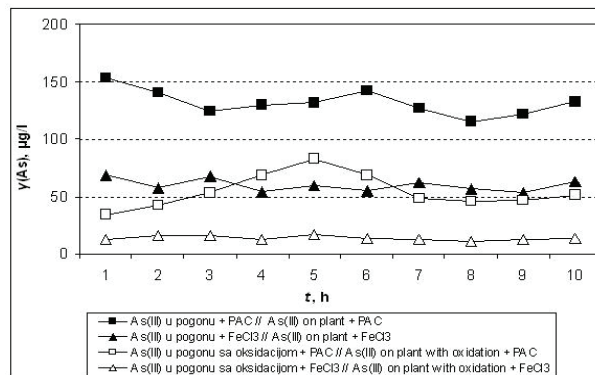

Slika 5. Koncentracija arsena(III) nakon obrade s FeCl_3 i PAC bez i s oksidacijom s 1 %-tnom otopinom KMnO_4
Fig. 5. Arsenic(III) concentration after treatment with FeCl_3 and PAC without and with oxidation using 1 % KMnO_4 solution

Pilot linija s PAC-om imala je puno lošiji rezultat, te je ukupni arsen na liniji bez oksidacije iznosio 149,67 µg As/l, a na pilot-liniji s oksidacijom 87,21 µg As/l (Slika 4). Prosječna koncentracija As(III) na pilot liniji bez oksidacije uz PAC iznosila je 131,3 µg As/l, a na liniji s oksidacijom 54,25 µg As/l (Slika 5).

Prikazani rezultati ukazuju da je pri istim uvjetima uspješnija oksidacija 1 %-tnom otopinom KMnO₄ uz koagulant FeCl₃ pri čemu se uklanja oko 85 % ukupnog arsena i 93 % od početne koncentracije As(III), dok se uz koagulant PAC uklanja 64 % ukupnog arsena i 75 % As(III). Bez oksidacije uz koagulant FeCl₃ uklanja se 66 % ukupnog arsena i 73 % As(III), a s PAC-om bez oksidacije uklanja se 39 % ukupnog arsena i 40 % As(III).

Kako je As(III) mnogo toksičniji od As(V) i organskih vrsta arsena, oksidativni tretman podzemne vode s kemikalijama može poslužiti za smanjenje toksičnosti arsena olakšavajući njegovo uklanjanje iz vode. (Edwards, 1994; Hering et al., 1996).

Zaključak

U bogatoj ponudi tehnoloških rješenja vrlo je teška i odgovorna zadaća investitora da odabere najbolji postupak. Neovisne temeljite analize mogućih tehnoloških rješenja, uz odgovarajuća ispitivanja i provjere pomoću pilot-postrojenja mogu pri odabiru tehnologija znatno smanjiti rizik krivog investiranja. Osim što se treba osigurati voda odgovarajuće kakvoće, odabrani tehnološki postupak za uklanjanje arsena mora zadovoljiti i još dva nužna kriterija: dostupan nivo ulaganja i cijenu vode koja će biti dostupna potrošačima. Oksidacijom osječke prerađene podzemne vode sa 1,5 mgO₃/l uz dodatak 1,2 mgFe/l, koncentracija ukupnog arsena se smanji za oko 30 %, a koncentracija As(III) za 33 %, dok oksidacijom sa 3,0 mgO₃/l koncentracija ukupnog arsena se smanji za oko 74 %, a koncentracija As(III) za 65 %.

Oksidacijom neprerađene podzemne vode s 1 %-tnom otopinom KMnO₄ uz koagulant FeCl₃ uklanja se oko 85 % ukupnog arsena i 93 % arsena(III), dok uz koagulant PAC ukupni arsen se uklanja 64 %, a arsen(III) tek 75 %. Primjenom koagulanta FeCl₃ bez oksidacije uklanja se 66 % ukupnog arsena i 73 % arsena(III), a s PAC-om bez oksidacije uklanja se 39 % ukupnog arsena odnosno 40 % od početne koncentracije arsena(III).

Literatura

Application Bulletin 226/2 e (2003): Determination of arsenic by ASV at the rotating gold electrode, Metrohm, Zürich.

DR /2000 Spectrophotometer Handbook (2000), Loveland, USA.

Edwards, M.(1994): Chemistry of arsenic removal during coagulation and Fe-Mn oxidation, *J. Am. Water Works. Assoc.* 86 (9), 64-78.

Eisler, R. (1988): Arsenic, Hazards to Fish, Wildlife and Invertebrates: A Synoptic Review, *Contaminant Hazard Reviews* 12, 92-99.

Hering, J.G., Chen,P.Y., Wilkie, J.A., Elimelech, M., Liang, S.(1996): Arsenic removal by ferric chloride, *J. Am. Water Works Assn.*, 88(4), 155-167.

- Kim, M.J., Nriagu, J. (2000): Oxidation of arsenite in groundwater using ozone and oxygen. *Sci. Total Environ.* 47, 71-79
- Kopanica, M., Novotny, L. (1998): Determination of traces of arsenic(III) by anodic stripping voltametry in solutions, natural waters and biological material, *Anal. Chim. Acta*, 3, 211-218
- Pongratz, R. (1998): Arsenic Speciation in Environmental Samples of Contaminated Soil, *Sci. Total Environ.*, 224, 133-141
- Smedley, P.L., D.G Kinniburgh, D.G. (2002): A review of the source, behaviour and distribution of arsenic in natural waters, *Appl. Geochem.* 17, 517-568
- World Health Organisation, Environ. Health Criteria 224(2001): Arsenic and Arsenic Compounds, 2nd ed., WHO, Geneva

The efficiency of arsenic removal using oxidation processes in the well water treatment in Vodovod-Osijek

Ž. Romić¹, B. Kalajdžić², M. Habuda-Stanić²,
D. Pichler¹, M. Kuleš²

¹VODOVOD OSIJEK d.o.o., PJ Municipal Waterworks, RJ Laboratory, Poljski put 1, 31000 Osijek, Croatia

²University of Josip Juraj Strossmayer in Osijek, Faculty of Food Technology Osijek, Franje Kuhača 20, Osijek, Croatia

Summary

Well water, which is used for water-supply of the city of Osijek, generally does not meet health standards for drinking water due to the high content of organic matter, iron, manganese, arsenic and ammonia. A particular problem in the treatment process of this well water is arsenic. Researches show that it is difficult to remove trivalent arsenic with conventional water treatment technologies, and it appears an inevitable need for the oxidation of highly toxic As(III) to less toxic As(V). The parameters that control the mobility of arsenic are pH and redox-potential (PE). Electrostatic charge of As (III) and As(V) significantly affect the removal process. The purpose was to find the most appropriate oxidation process to ensure adequate water quality. The results suggest that oxidation of the Osijek groundwater with 1.5 mgO₃/l with the addition of 1.2 mgFe/l decreases total arsenic concentration for about 30 % and As(III) for 33 % of initial concentration, while oxidation with 3.0 mgO₃/l with the addition of 1.2 mgFe/l, decreases total arsenic concentration for about 74 %, and As(III) for 65 %. About 85 % of total arsenic and 93 % of arsenic(III) are removed when 1 % KMnO₄ solution with coagulant FeCl₃ is used, while the polyaluminium chloride coagulant removes 64 % of total arsenic and 75 % of arsenic (III).

Keywords: well water, oxidation, processing technology, arsenic removal

Voda donosi život

UDC: 504.45 (497.5 Kopački rit)

V. Rožac*, L. Benčina

Javna ustanova "Park prirode Kopački rit", Titov dvorac 1, 31328 Lug, Hrvatska

Sažetak

Kopački rit je područje dobro očuvane prirode čiji je mozaični krajobraz nastao pod utjecajem dviju velikih rijeka Dunava i Drave. U njemu se napreskokce izmjenjuju povišenja terena (grede), depresije (bare), jezera i kanali, a nastali su dinamikom plavljenja i povlačenja vode ovih dviju rijeka. Kako bi se ovaj prirodni fenomen očuvao, potrebno ga je temeljito upoznati i redovito pratiti stanje prirode u njemu. Imajući na umu značaj vode za Kopački rit, Javna ustanova samostalno, ali i u suradnji s drugim javnim ili sveučilišnim institucijama, konstantno prati stanje voda u njemu, prateći čimbenike koji to pokazuju. Od abiotičkih su to razina podzemnih i površinskih voda, kvalitativni sastav površinske vode, sedimentacija i kemijski sastav sedimenta, temperatura zraka, tla i oborine. Od biotičkih stalno se prati stanje ptica močvarica, gniježđenje ptica na vrhu hranidbenog lanca i kolonijalnih ptica, stanje populacije dabrova, ihtiofauna te prostorni raspored, zastupljenost i sastav vodenih i močvarnih staništa. Ovom prilikom bit će objavljeni rezultati praćenja stanja Javne ustanove.

Ključne riječi: Kopački rit, voda, zaštita prirode, biotički i abiotički ekološki čimbenici

Uvod

Poplavno područje Parka prirode Kopački rit nastalo je pomicanjem i meandriranjem korita rijeka Dunava i Drave. Osnovno ekološko obilježje ovom prostoru daje dinamika plavljenja, tako da o količini pristigle vode ovisi izgled cijelog prostora, odnosno pojedinih biotopa. Stoga se sa sigurnošću može reći kako je za rit voda osnovni element iz kojeg proizlaze specifične ekološke prilike koje omogućuju razvoj brojnog i raznolikog biljnog i životinjskog svijeta. Tijekom posljednjih dvjestotinjak godina zbog utjecaja antropogenih aktivnosti na dinamiku oblikovanja korita i naplavnih ravni Dunava i Drave (regulacijski i hidromelioracijski radovi) izvršen je značajan utjecaj na oblikovanje reljefa i vodenih površina u Parku. Smanjenju vodenih površina u ritu, osim promijenjenog hidrološkog režima pridonose i procesi zamuljivanja i zasipavanja postojećih bara i kanala. Kako bi se sačuvao ovaj izuzetno vrijedan ekološki sustav potrebno ga je trajno zaštititi tj. kontinuirano pratiti stanje na osnovu kojeg bi bilo moguće poduzeti određene, ekološki prihvatljive mjere u svrhu rješavanja navedene problematike. Upravo iz tog razloga Javna ustanova

* vlatko.rozac@kopacki-rit.hr

samostalno i u suradnji s drugim javnim i sveučilišnim institucijama redovito prati stanje određenih abiotičkih i biotičkih čimbenika koji predstavljaju trenutne indikatore stanja ovog ekosustava. Prikupljanjem i analizom nabrojanih čimbenika kroz duži vremenski period bit će moguće dobiti potpuniju sliku stanja ekosustava.

Abiotički čimbenici

Razina površinskih voda – redovito se mjeri razina unutarnjih voda PP Kopački rit. Podatke o vodostajima Dunava i Drave redovito nam dostavljaju Hrvatske vode. Rezultati analize prikazani su u poglavlju Rezultati.

Kvalitativni sastav površinskih voda – u suradnji s Prehrambeno tehnološkim fakultetom iz Osijeka i Zavodom za javno zdravstvo Osječko-baranjske županije provedena je analiza voda u branjenom području Parka prirode. U suradnji s Rudarsko geološko naftnim fakultetom iz Zagreba tj. Hrvatskim veterinarskim institutom iz Zagreba također su napravljene bakteriološke i virološke pretrage uzorka vode iz Kopačkog jezera. Monitoring se ne provodi sustavno.

Sedimentacija i kvalitativni sastav sedimenta – ispitivanje hidrogeološke komponente u sklopu projekta „Praćenje tektonskih i hidrogeoloških aktivnosti u Parku prirode Kopački rit“ provodi se u suradnji s Rudarsko geološko naftnim fakultetom iz Zagreba. Rezultati analize nisu još poznati. U suradnji s navedenim fakultetom i Hrvatskim veterinarskim institutom iz Zagreba napravljene su bakteriološke i virološke pretrage mulja iz Kopačkog jezera. Rezultati analize su poznati no monitoring se ne provodi sustavno.

Razina podzemnih voda – od kraja 2009. godine redovito se mjeri razina podzemnih voda u PP Kopački rit. Rezultati analize prikazani su u poglavlju Rezultati.

Oborine – u suradnji s Državnim hidrometeorološkim zavodom provodi se redoviti monitoring količine i vrste oborina te visine snježnog pokrivača. Rezultati analize prikazani su u poglavlju Rezultati.

Biotički čimbenici

Ptice močvarice – redovito se provodi monitoring ptica močvarica. Rezultati analize prikazani su u poglavlju Rezultati.

Gniježđenje ptica na vrhu hranidbenog lanca – redovito se provodi monitoring gniježđenja orla štekavca (*Haliaeetus albicilla*). Rezultati analize prikazani su u poglavlju Rezultati.

Gniježđenje kolonijalnih vrsta ptica – redovito se provodi monitoring gniježđenja sive čaplje (*Ardea cinerea*) i velikog vranca (*Phalacrocorax carbo*). Rezultati analize prikazani su u poglavlju Rezultati.

Distribucija populacije europskog dabra (Castor fiber) – redovito se prati distribucija populacije na području Parka. Distribucija populacije dabara prikazana je u poglavlju Rezultati.

Tijekom 2007. godine u suradnji s Poljoprivrednim fakultetom iz Osijeka provedeno je istraživanje kvalitativno-kvantitativnog sastava ihtiofaune, njene strukture, kondicijskog i zdravstvenog stanja te kategorizacija ugroženosti. Istraživani parametri svakako su pokazatelji boniteta određenog staništa. Nakon toga monitoring nije sustavno proveden. Monitoring izlovnih kvota tradicionalnih ribara započet je u 2010. godini.

Monitoring prostornog rasporeda, zastupljenosti i sastava vodenih i močvarnih staništa – tijekom 2010. godine u suradnji s Poljoprivrednim fakultetom iz Osijeka započet je projekt Inventarizacija vodenih i močvarnih staništa Parka prirode Kopački rit u sklopu Akcijskog plana za zaštitu vodenih i močvarnih staništa u PP Kopački rit.

Materijali i metode

Abiotički čimbenici

- *Hidrologija i meteorologija*

Unutarnje vode Kopačkog rita mjerene su na crpnoj stanici Tikveš, koja je na Vemeljskom dunavcu i na ustavi Kopačevo, koja je na jezeru Sakadaš. Na ustavi Kopačevo, na vodomjernoj letvi svakodnevno se mjeri vodostaj jezera Sakadaš. Na crpnoj stanici Tikveš vodostaj se mjeri samo ako prelazi mjeru 100, a mjerenje provode Hrvatske vode kao i vodostaje Dunava i Drave te ih dostavljaju elektronskom poštom. Vodostaji se prate na sljedećim postajama: za Dunava su to Batina, Apatin i Aljmaš, za Dravu je Osijek, a za unutarnje vode Kopačkog rita su crpna stanica Tikveš i ustava Kopačevo.

Podzemne vode mjere se u području Kopačkog rita branjenom od poplave (zapadno od nasipa), na šumarskim piezomama u šumi u blizini Zlatne Grede, tzv. piezoma-Zlatna Greda i u šumi blizu Komplexa dvorca Tikveš, tzv. piezoma-KD Tikveš, te na poljoprivrednoj piezomi pored oranice na Malomkutu, tzv. piezoma-Malomkut. Mjere se i na dva bunara i to u ostavi u Komplexu dvorca Tikveš, tzv. bunar-ostava i na bunaru u selu Tikveš, tzv. bunar-Tikveš. Bunar-ostava je u zatvorenom prostoru, a voda iz njega se ne upotrebljava dok je bunar-Tikveš na otvorenom, a vodu upotrebljavaju stanovnici sela. Stoga je nerijetko bio slučaj da su rezultati mjerenja na bunaru-Tikveš odstupali od izmjerenih vrijednosti podzemnih voda na ostalim lokacijama.

Radi usporedbe ovisnosti podzemnih voda o vodostajima Dunava i Drave, odnosno o oborinama, uspoređene su njihove tendencije. Upravo tendencije jasno pokazuju kada padaju ili rastu razine podzemnih i površinskih voda.

Podatke o oborinama i snježnom pokrivaču svakodnevno se prate na meteorološkoj postaji u Kompleksu dvorca Tikveš. Količine oborina bilo je jednostavno uvrstiti u grafikon, dok je za količinu otopljenog snijega bilo potrebno uzeti razliku visine snježnog pokrivača i visine novo napadanog snijega.

Biotički čimbenici

- *Monitoring ptica močvarica*

Ptice močvarice se drže otvorenih prostora i u blizini vode. Stoga su promatrane iz veće udaljenosti dalekozorima i teleskopom. Monitoring se radi jednostavnim prebrojavanjem svih opaženih ptica na nekom lokalitetu u Parku te se sve bilježi u dnevnik promatranja. Lokaliteti su podijeljeni i determinirani na način da svaki za sebe čini jedno stanište. Učestalost pojavljivanja neke vrste na različitim lokalitetima u Parku u određenom trenutku govori nam o trenutnoj distribuciji neke vrste. S obzirom na takvu distribuciju, može se odrediti koje su vrste dominantne odnosno čija populacija u jednom trenutku zauzima najveću površinu. Dominantnost vrsta ptica močvarica u Kopačkom ritu s obzirom na distribuciju po lokalitetima računa se kao postotak pojavljivanja vrste u Kopačkom ritu na zabilježenim lokalitetima.

- *Monitoring orla štekavca (*Haliaeetus albicilla*)*

Uspješnost gniježđenja orla štekavca (*H. albicilla*) prati se bilježenjem aktivnosti svih poznatih lokacija orlovih gnijezda u Parku te obilježavanjem svakog gnijezda GPS uređajem. Aktivnost gniježđenja pratimo u razdoblju od 1. siječnja do 15. srpnja svake godine što se vodi kao sezona gniježđenja ptica. Lokacije se unose na kartu na podlozi: topografska karta 1:25000 1968. – 1972. godine. Za rad na kartama koristi se u software ArcGIS verzija 9.3.1.

- *Monitoring gniježđenja kolonijalnih vrsta ptica*

Uspješnost gniježđenja kolonijalnih vrsta ptica, sive čaplje (*Ardea cinerea*) i velikog vranca (*Phalacrocorax carbo*) prati se jednostavnim prebrojavanjem svih aktivnih gnijezda u koloniji te obilježavanjem kolonija GPS uređajem.

- *Monitoring europskog dabra (*Castor fiber*)*

Kod monitoringa europskog dabra (*C. fiber*) prati se za sada jedino distribucija njegove populacije u Parku ovisno o lokacijama nastambi i aktivnosti. Lokacije se unose na kartu na podlozi: orto-foto snimak 2002. – 2007. godine. Aktivnost dabrova se prepoznaje po drveću koje su porušili. U suradnji sa Šumarskim

fakultetom iz Zagreba 2007. godine postavili smo kamere na mjestu na kojem su prvobitno pronađene njihove nastambe i utvrđena njihova aktivnost.

Rezultati

Abiotički čimbenici

- *Hidrologija i meteorologija*

Na Slikama 1 i 2 jasno je vidljiva ovisnost unutarnjih voda Kopačkog rita (CS Tikveš i Sakadaš) o vodostajima Dunava (Batina, Apatin, Aljmaš) i Drave (Osijek). Vidljivo je i da vodostaji Dunava i Drave variraju na sličan način. No ono što se ističe je neovisnost vodostaja Sakadaša o rijekama pri vrlo niskim vodostajima.

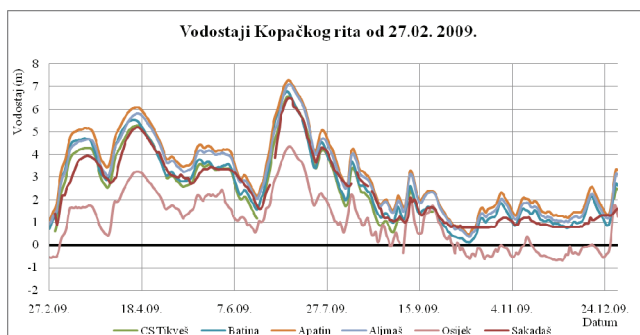

Slika 1. Vodostaji Kopačkog rita u 2009. godini od 27.02.
Fig. 1. Water-levels of Kopački rit in year 2009. since 27.02.

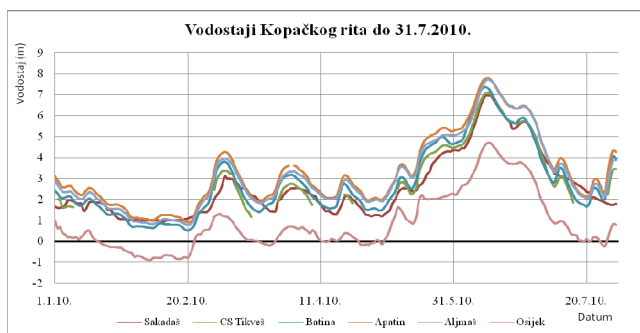

Slika 2. Vodostaji Kopačkog rita u 2010. godini do 31.07.
Fig. 2. Water-levels of Kopački rit in year 2010. till 31.07.

Na Slici 3 vidljivo je kako je razina podzemnih voda na mjernim postajama varirala podjednako. Pojedinačna odstupanja su najvjerojatnije bila posljedica greške očitavanja prilikom uzorkovanja. Osim kod bunara-Tikveš kod kojeg je odstupanje bilo moguće zbog njegovog položaja i upotrebe.

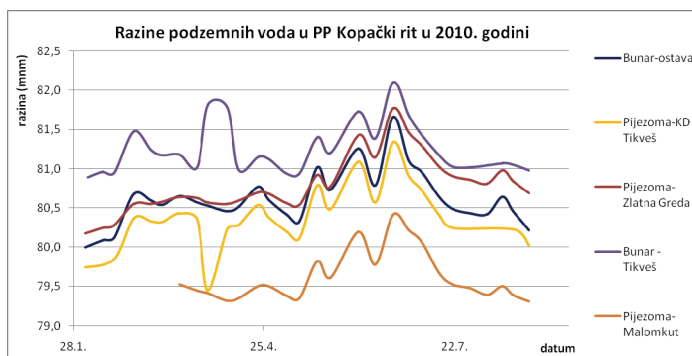

Slika 3. Razine podzemnih voda u branjenom području Kopačkog rita u 2010. godini
Fig. 3. Levels of ground water in flood-defended area of Kopački rit in year 2010.

Prema podacima Državnog hidrometeorološkog zavoda (www.dhmz.hr), ova godina je bila iznadprosječna po količini oborina (Slika 4).

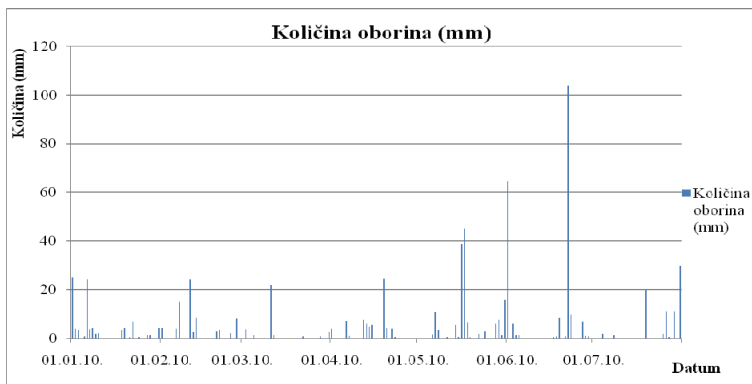

Slika 4. Količina oborina u Kopačkom ritu u 2010. godini
Fig. 4. amount of precipitation in Kopački rit in year 2010.

Kada se uspoređi ovisnost podzemnih voda o vodostajima Kopačkog rita i o oborinama, dobiju se rezultati, kako je vidljivo na Slikama 5 i 6.

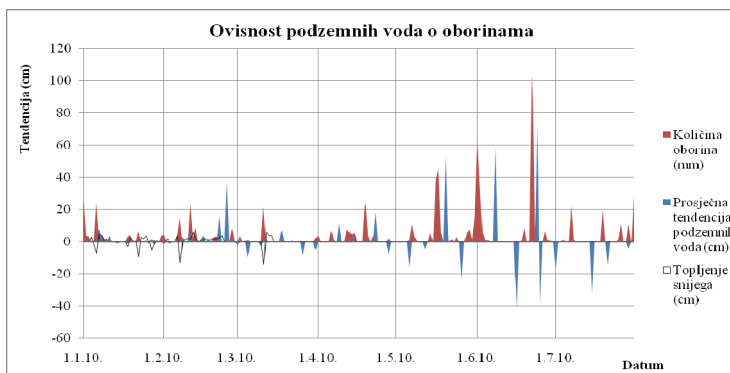

Slika 5. Ovisnost prosječnih tendencija podzemnih voda o količini oborina i topljenu snijega
Fig. 5. Correlation of average tendencies of ground water and amount of precipitation and snow melting

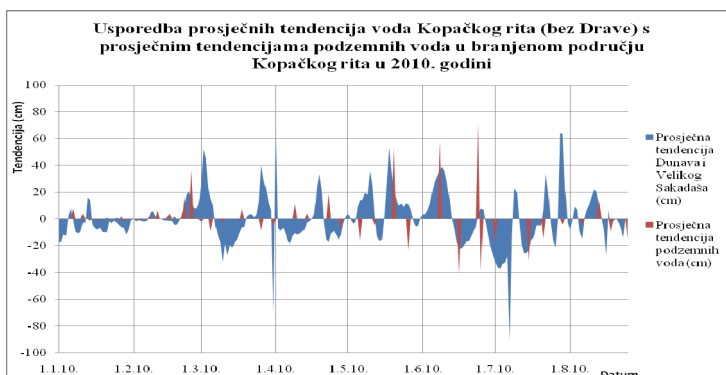

Slika 6. Usporedba prosječnih tendencija voda Kopačkog rita (bez Drave) s prosječnim tendencijama podzemnih voda u branjenom području u 2010. godini
Fig. 6. Comparison of average tendencies of waters of Kopački rit (without Drava River) and tendencies of ground water in flood-defended area in year 2010

Na Slici 5 za usporedbu je uzeta prosječna tendencija podzemnih voda i oborina, a u zimskom preiodu je dodan i čimbenik topljenja snijega. Na slici 6 za usporedbu su uzete prosječne tendencije vodostaja Dunava, Vemeljskog dunavca i jezera Sakadaš. U prosjek nije računata Drava jer je to druga rijeka, a ona na vode Kopačkog rita ima mali utjecaj (Bonacci et al., 2002). Vidljivo je da podzemne vode branjenog područja Kopačkog rita ne ovise o vodostaju Dunava. Na Slici 5 vidi se vrlo jasna ovisnost podzemnih voda o oborinama, dok se na Slici 6 povezanost između voda Kopačkog rita u poplavlom području i podzemnih voda u branjenom području ne uočava jasna povezanost.

- *Monitoring ptica močvarica*

Na Slikama 7 i 8 vidljivo je kako se situacija kod ptica močvarica nije značajno promijenila, a populacija sive čaplje (*A. cinerea*) i dalje dominira na močvarnim staništima Kopačkog rita.

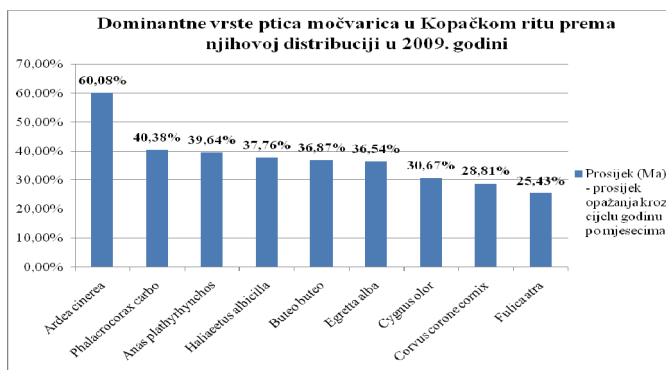

Slika 7. Dominantne vrste ptica močvarica s obzirom na njihovu distribuciju u 2009. godini
Fig. 7. Dominant species of water birds according to their distribution in year 2009

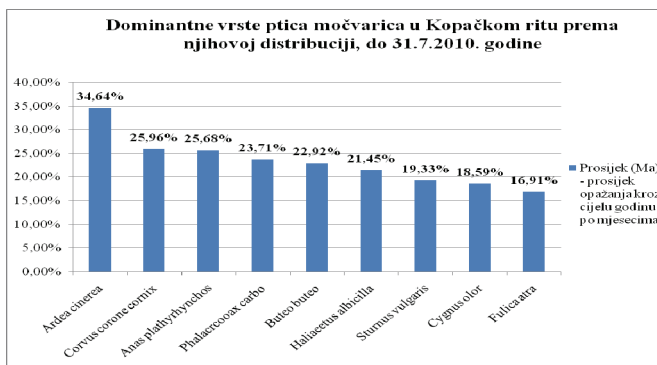

Slika 8. Dominantne vrste ptica močvarica s obzirom na njihovu distribuciju u 2010. godini do 31. srpnja

Fig. 8. Dominant species of water birds according to their distribution in year 2010 till 31 July

Postotak pojavljivanja vrsta po lokalitetima nešto je manji u 2010. godini iz razloga što je u samom načinu rada prilikom jednog izlaska na teren obično više lokaliteta te nedostaje jesen kao godišnje doba kada je u Kopačkom ritu radi migracije prisutan najveći broj vrsta ptica. To je ujedno i razlog nekim manjim oscilacijama u rezultatima između 2009. i 2010. godine. Jedina značajnija promjena je povećanje distribucije sive vrane (*C. corone cornix*).

- *Monitoring orla štekavca (Haliaeetus albicilla)*

Na Slici 9 je, prema liniji trenda, vidljivo kako je gnijezdeća populacija orla štekavca (*H. albicilla*) u zadnjih 11 godina bila u laganom porastu, što znači da je stabilna.

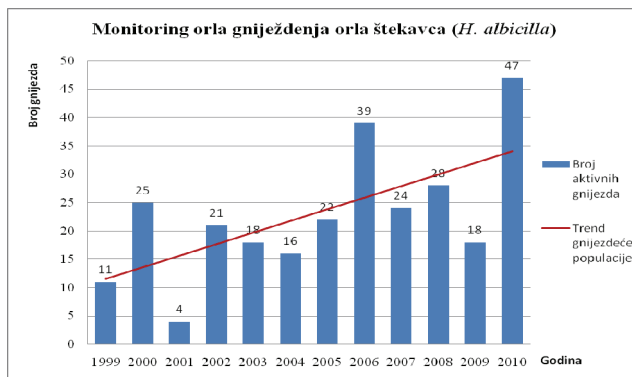

Slika 9. Monitoring orla gniježdenja štekavca (*H. albicilla*)
Fig. 9. Monitoring of nesting of white-tailed Eagle (*H. albicilla*)

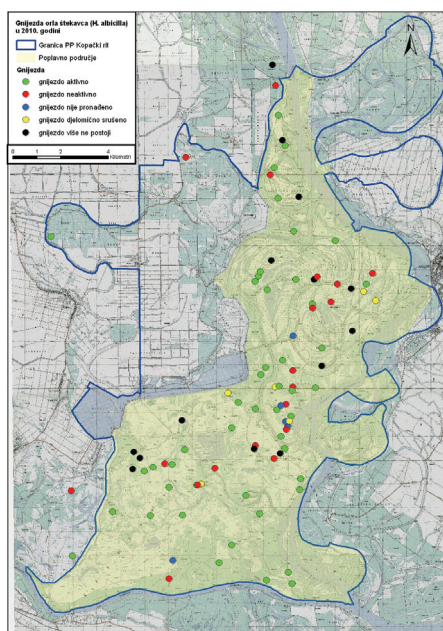

Slika 10. Raspored i aktivnost gniježdenja orla štekavca (*H. albicilla*) u 2010. godini;
podloga: TK 1:25000, 1968. - 72. godine

Fig. 10. Array and activity of nesting of white-tailed Eagle (*H. albicilla*) in year 2010;
background: TM 1:25000, year: 1968. - 72.

Varijacije u broju zabilježenih aktivnih gnijezda ovise o broju novih gnijezda te o broju provjerenih poznatih lokacija na kojima su se prethodne godine nalazila gnijezda. U 2010. godini utvrđen je do sada najveći broj aktivnih gnijezda (47). Međutim potrebno je istaknuti kako je u 2010. godini napravljena cjelokupna inventarizacija svih zabilježenih gnijezda na području Parka (ukupno 91 lokacija) što do sada nije učinjeno.

Većina gnijezdeće populacije nalazi se unutar poplavnog područja dok je samo jedan par zabilježen u branjenom području Parka (Slika 10).

- *Monitoring gniježđenja kolonijalnih vrsta ptica*

Na Slikama 10 i 11 jasno je vidljivo kako je kolonija velikog vranca (*P. carbo*) bila u porastu do kraja 80-tih godina prošloga stoljeća, dok je kod sive čaplje (*A. Cinerea*) najveća brojnost dostignuta 2000. godine. Nakon toga je kod obje kolonije uslijedila faza stagnacije, gdje im brojnost varira ovisno o kapacitetu staništa. Podaci u periodu od 1990./91. do 1998. nedostaju zbog ratnih zbivanja i okupacije Baranje.

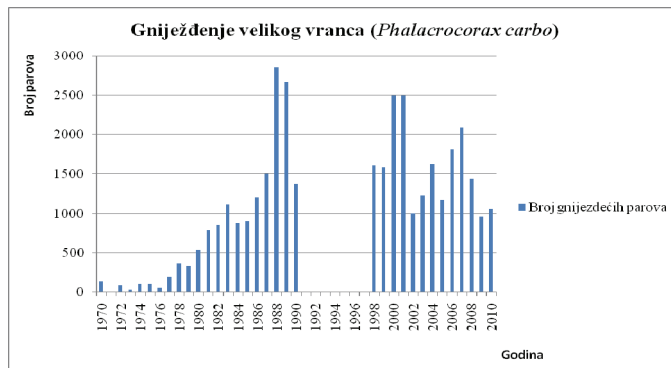

Slika 11. Monitoring gniježđenja velikog vranca (*P. carbo*)
Fig. 11. Monitoring of nesting of Cormorant (*P. carbo*)

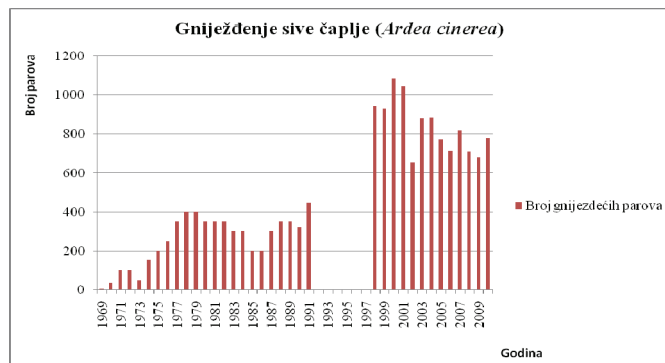

Slika 12. Monitoring gniježđenja sive čaplje (*A. cinerea*)
Fig. 12. Monitoring of nesting of Grey Heron (*A. cinerea*)

- *Monitoring europskog dabra (Castor fiber)*

Na Slici 13 vidljivo je kako se populacija europskog dabra širi na nova područja Kopačkog rita.

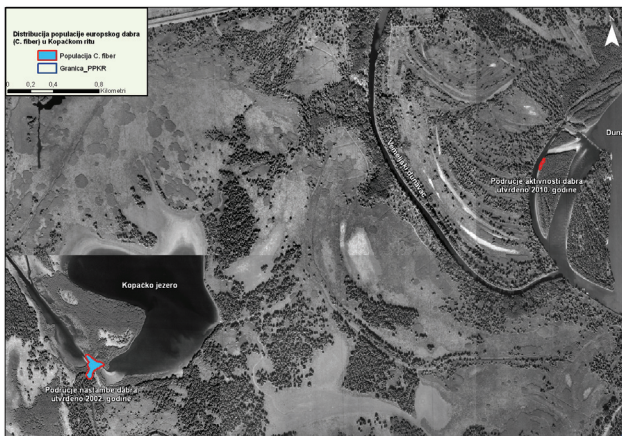

Slika 13. Distribucija populacije europskog dabra (*C. fiber*);
podloga: orto-foto snimak 2002. - 07. godine

Fig. 13. Distribution of population of European Beaver (*C. fiber*);
background orto-foto picture, year 2002. – 07.

Uočeno je kako na oba područja dabrovi ne grade brane budući su odabrana područja sa stalnom količinom vode koja je u jednom dijelu godine tekuća, a u jednom stajaća ili sporo tekuća. Vrlo su aktivni s obzirom na uočenu količinu srušenog drveća koje ruše radi ishrane. Aktivnost i nastambe europskog dabra (*Castor fiber*) na području Parka prirode prvi puta su uočene 2002. godine u Hulovskom kanalu. Postavljanjem kamera sa senzorom na pokret, prvi puta je foto-dokumentirano nekoliko jedinki ove vrste u Kopačkom ritu. Druga lokacija zabilježena je 2010. godine na „Starom Dunavu“, gdje je uočena njihova pojačana aktivnost s obzirom na količinu srušenog drveća.

Rasprava

Abiotički čimbenici

- *Hidrologija i meteorologija*

Poplavno područje Kopačkog rita dio je poplavnog područja Dunava i ovisi o njegovom vodostaju, osim ako je on vrlo nizak. Razlog tome je pregrada koja se nalazi na spoju Hulovskog kanala s Dunavom. Ona prilikom ekstremno niskih

vodostaja zadržava vodu u kanalu, a samim tim i u ritu, dok Dunav opada (Bonacci et al., 2002). Drava na unutarnje vode Kopačkog rita nema bitan utjecaj, a jedini je spoj preko Renovskog kanala.

Podzemne vode u branjenom području Kopačkog rita ovise isključivo o oborinskim pojavama i radu crpnih stanica (Podunavlje, Tikveš i Zlatna Greda) smještenih u Parku. Hrvatske vode reguliraju razinu vode u kanalskoj mreži, a samim tim i podzemne vode, u području branjenom od poplave pomoću crpnih stanica. Nadalje, u 2010. godini je, prema podacima Državnog hidrometeorološkog zavoda, pala nadprosječna količina oborina. To je izazvalo potope na poljoprivrednim usjevima, uzrokujući tako katastrofalne štete. Kako bi se štete umanjile, sve tri crpne stanice u Kopačkom ritu su od sredine veljače pa do pred kraj kolovoza crpile vodu iz branjenog u poplavno područje, te na taj način pomagale isušivanju poplavljenih polja. Ovakav način obrane od poplave i zaštite usjeva, dovodi do smanjenja razine podzemnih voda što direktno utječe na zdravlje i kondiciju obližnjih šuma. U ovom slučaju, podzemne vode su neovisne o vodostaju Dunava.

Biotički čimbenici

- *Monitoring ptica močvarica*

Na močvarnim staništima Kopačkog rita osim močvarica, često se javljaju i druge ptice. Jedna od njih je i siva vrana (*C. corone cornix*), jedna od najbolje distribuiranih ptica. Ova kozmopolitska podvrsta je izrazito prilagodljiva i prodorna u ekološkim sustavima. Kako na vodenim i močvarnim staništima Kopačkog rita zapravo nema pravog konkurenta u istoj niši, za očekivati je da će ona zauzeti svoj prostor, a postoji mogućnost da postane dominantna vrsta s obzirom na distribuciju. Druga je mogućnost, da je ova izrazito kišna godina jednostavno pogodovala sivoj vrani te će njena distribucija varirati ovisno o uvjetima staništa. Ovo su neki od mogućih ishoda temeljeni na monitoringu nešto kraćem od dvije godine. Za sigurnije pretpostavke potrebno je provoditi daljnji monitoring.

- *Monitoring orla štekavca (H. albicilla)*

Orlovi štekavci se redovito gnijezde na ovom području, a od 1999. godine provodi se monitoring njihove populacije. Do 2010. godine zabilježili smo 91 gnijezdo. Nisu sva gnijezda aktivna, a za mnoga smo utvrdili da su se u navedenom vremenskom periodu srušila ili su napuštena. Naime, poznato je kako u Kopačkom ritu jedan par orlova može imati više od jednog gnijezda. To se događa u slučaju kada isti par jedne godine sagradi novo gnijezdo ako mu stara lokacija ne odgovara ili ako mu oluja sruši dio gnijezda. Taj se par sljedeće godine može vratiti na staro gnijezdo i obnoviti ga. Ovo govori o činjenici kako kapacitet okoliša za orlove u Kopačkom ritu nije prezasićen te ima dovoljno prostora i hrane za povećanje gnijezdeće

populacije. U 2010. godini napravljena je cjelokupna inventarizacija svih do sada zabilježenih gnijezda na području Parka (ukupno 91 lokacija) i zabilježen je do sada najveći broj aktivnih gnijezda (47). Zbog toga ne možemo sa sigurnošću govoriti o brzini porasta gnijezdeće populacije. Realni porast utvrdit će se provedbom jednako kvalitetnog monitoringa u sljedećim godinama. Važno je istaknuti kako je gnijezdeća populacija smještena skoro u potpunosti u poplavnom području, koje je zbog čestih poplava nedostupno i neprohodno te je tako ljudska aktivnost smanjena za razliku od branjenog područja.

- *Gniježđenje kolonijalnih vrsta ptica*

Kolonije velikog vranca (*P. carbo*) i sive čaplje (*A. cinerea*) u Kopačkom ritu su stabilne. Oscilacije koje se pojavljuju iz godine u godinu, nakon završetka okupacije Baranje, rezultat su promjene uvjeta okoliša. U sklopu zaštite i očuvanja prirodnih vrijednosti Parka prirode Kopački rit Javna ustanova nastoji poboljšati kvalitetu staništa za ptice močvarice. Stoga se u zadnje dvije godine, u suradnji s Hrvatskim vodama nastoji napuniti ribnjake Podunavlje dovoljnim količinama vode koja bi se u njima zadržala veći dio godine, te bi se tako osigurali povoljni uvjeti za ishranu i opstanak za sve vrste ptica močvarica. To se pokazalo vrlo učinkovitim za sive čaplje, ali i za druge kolonijalne vrste kao što su bjelobrade čigre (*C. hybrida*), koje već drugu godinu zaredom održavaju svoju koloniju na ribnjacima.

- *Monitoring europskog dabra (C. fiber)*

Budući su navedena područja sa stalnom količinom vode koja je u jednom dijelu godine tekuća, a u jednom stajaća ili sporo tekuća uočeno je kako na oba područja dabrovi ne grade brane. Odnosno, razina vode na navedenim lokacijama nikada ne bude toliko niska da dabar ima potrebu graditi branu kako bi zadržao vodu na njemu optimalnoj razini. Tijekom proljetnih i ljetnih poplava, kada u rit uđe velika količina vode, te vodostaj unutarnjih voda znatno poraste, na području gdje su uočene njihove nastambe nismo uočili njihovu aktivnost te pretpostavljamo da se u navedenom periodu povuku na neka viša mjesta.

Literatura

- Bognar, A., Prelogović, E., Urumović, K., Lozić, S., Đokić, M., Kerovec, M., Kereković, A. (2002): Park prirode Kopački rit Plan upravljanja: Sektorska studija Geologija i geografija, Sveučilište u Zagrebu, Prirodoslovno-Matematički Fakultet i Rudarsko-Geološko-Naftni Fakultet, Zagreb, HR.
- Bonacci, O., Tadić, Z., Moržan, A., Radeljak, I. (2002): Park prirode Kopački rit Plan upravljanja: Sektorska studija Hidrologija i meteorologija, Hidroing d.o.o. za projektiranje i inženjering, Osijek, HR.
- Državni hidrometeorološki zavod. Dostupno na: www.dhmz.hr

- Habuda-Stanić, M. (2008): Razine podzemnih voda na području Baranje u periodu 1980. – 2006, Sveučilište Josipa Jurja Strossmayera u Osijeku, Prehrambeno-tehnološki fakultet, Katedra za Tehnologiju vode i ekologiju, Osijek, HR.
- Horvatić, J., Gucunski, D., Mrakovčić, M., Krčmar, S., Merdić, E., Lukač, G., Mišetić, S., Ozimec, S., Popović, Ž. (2002): Park prirode Kopački rit Plan upravljanja: Sektorska studija Biodiverzitet, Sveučilište Josipa Jurja Strossmayera u Osijeku, Pedagoški fakultet, Zavod za biologiju, Osijek, HR.
- Mihaljević, M., Getz, D., Tadić, Z., Živanović, B., Gucunski, D., Topić, J., Kalinović, I., Mikuska, J. (1999): Kopački rit, pregled istraživanja i bibliografija. Hrvatska akademija znanosti i umjetnosti, Zavod za znanstveni rad, Osijek, Zagreb – Osijek, HR.
- Mikuska, J., Bogdanović, T., Mikuska, T., Mikuska, A., Ščetarić, V. (2005): Size and distribution of breeding colonies of Grey Heron *Ardea cinerea* in lowland Croatia, *Acrocephalus*. 26(124): 37-40.
- Opačak, A., Florijančić, T., Stević, I., Majić, S., Jelkić, D., Lužaić, R. (2008): Hidrobiološki aspekti Reprodukcijske ihtiofaune u Kopačkom ritu za 2007. godinu, Sveučilište Josipa Jurja Strossmayera u Osijeku, Poljoprivredni fakultet u Osijeku, Zavod za lovstvo, ribarstvo i pčelarstvo, Katedra za lovstvo, ribarstvo i ekologiju, Osijek, HR.
- Opačak, A., Florijančić, T., Stević, I., Majić, S., Jelkić, D., Lužaić, R. (2008): Struktura, distribucija i abudanca ihtiofaune Kopačkog rita za 2007. godinu, Sveučilište Josipa Jurja Strossmayera u Osijeku, Poljoprivredni fakultet u osijeku, Zavod za lovstvo, ribarstvo i pčelarstvo, Katedra za lovstvo, ribarstvo i ekologiju, Osijek, HR.
- Radović, D., Kralj, J., Tutiš, V., Čiković, D. (2003): Crvena knjiga ugroženih ptica Hrvatske, Ministarstvo zaštite okoliša i prostornog uređenja, Zagreb, HR.

Water brings life

V. Rožac, L. Benčina

Public Institution "Nature Park Kopački Rit", Titov dvorac 1, 31328 Lug, Croatia

Summary

Kopački rit is well-preserved natural mosaic landscape which came under influence of two great rivers Danube and Drava. The parts of the swamp land and water, arranged mosaically as terrain elevations (beams), depression (ponds), lakes and channels, which came as a result of dynamics of flooding and drawdown of water in these two rivers. In order to preserve this natural phenomenon, it should be thoroughly familiar and regularly monitor the state of nature in it. Bearing in mind the importance of water for Kopački rit, Public institution independently, but in cooperation with other public or university institutions, constantly monitors the status of water in it following factors that indicates the state. Abiotic factors are: level of ground and surface water, sedimentation and chemical composition of sediment, air temperature, soli and precipitation. Biotic factors are: the status of water birds, nesting of birds of prey and colonial birds, distribution of beaver population, ichthyofauna spatial distribution, frequency and composition of aquatic and wetland habitats. On this occasion, Public institution will publish the results of monitoring.

Keywords: Kopački rit, water, nature protection, biotic and abiotic ecological factors

Environmental management in Croatia: challenges for small business

UDC: 504.06 : 334.71 (497.5)

M. Šučur^{1*}, R. Pinto²

¹*Croatian SME Agency (HAMAG), Prilaz Gjure Deželića 7, 10000 Zagreb, Croatia*

²*Pinto Consulting GmbH, Geusbleek 7, 21435 Stelle, Germany*

Summary

The paper examines entrepreneurs' attitudes and responses towards environmental management in the Croatian economy, based on a large sample survey of small businesses and crafts. The paper investigates environmental issues such as attitudes to the importance of environmental regulation changes for the operation of businesses within the framework of Accession of Croatia to the European Union (EU) and level of awareness of these changes. The results of the survey show that environmental regulations are indeed recognised and ranked as the top legislative area which is considered to be important for Croatian businesses, with exports having the top score. Over half of the entrepreneurs who consider environmental regulations to be important and are informed about legislative changes, have already undertaken specific activities in order to ensure compliance. Despite the high importance of environmental regulations to small businesses, the findings are mixed as well as impact on doing business.

Keywords: small businesses, environmental management and compliance, regulations

Introduction

Transposition and harmonization of the national legislation with the *acquis communautaire* (*acquis*) is a prerequisite for Accession to the EU. Consequently, over the last eight years, the relevant Croatian public institutions have been working on harmonization of environmental laws and regulations with the environmental *acquis* (GRC, 2003-2009). This process, coupled with national environmental priority issues, has resulted in a soaring number of environmental regulations, introducing new administrative burdens and investment costs for the regulated entities.

The fundamental purpose of regulation, from an economic point of view, is to correct inefficiencies. Such inefficiencies may take a form of environmental degradation due to presence of external environmental costs. If there is no regulation designed to account for externalities, businesses face inadequate incentives and continue to pollute. Depending on its design, environmental regulations provide two types of incentives: “static” incentives using direct

* msucur@hamag.hr

regulatory approach, so-called “command and control” (CAC) approach, to abate pollution with given technologies and “dynamic” incentives to develop and adopt cleaner technologies using economic instruments (Johnstone and Labonne, 2006). Croatian environmental regulations utilize both types of incentives via CAC and economic instruments (Šučur et al., 2007). As the accession date approaches, it is timely to assess the attitudes to the importance of changes in environmental regulations to doing businesses and the level of awareness of and preparedness for these changes. Due to their relative lack of resources (both financial and non-financial), small and medium size enterprises (small businesses) are of particular interest when examining these issues (EC, 2007). They are, therefore, the focus of this paper.

The paper is structured as follows. The next section presents the methodology and sample design of a survey focusing on small and medium size enterprises and larger crafts. In the subsequent section, we analyse the survey results. The final section highlights a set of policy conclusions.

Methodology

An EU-funded project, the Improving Information to the Croatian Business Community, carried out the Business Information Needs Survey in 2009. The quantitative research was conducted using computer assisted telephone interviewing (CATI) on a sample of 2,000 small businesses. The main goal of the sample survey was to investigate attitudes to the importance of environmental regulations, level of awareness and degree of preparedness for the legislative changes.

In order to conduct the survey in structured manner, a questionnaire was drafted; the average duration of the telephone interviews was approximately 20 minutes. The sample was taken from small and medium enterprises and larger crafts. Small and medium enterprises were defined as enterprises having up to 250 employees. Most crafts in Croatia are very small and have no employees, other than the owner of the business. Therefore, the sample survey focused on the larger crafts, defined as those with more than 5 employees.

The source of the sample of enterprises was the Financial Agency’s (FINA) database, since this is regarded as being the most comprehensive source of registered enterprises. Given that the FINA’s database is incomplete in case of crafts (due to legal requirements regulating reporting obligations), a different database was used, namely the Poslovna Hrvatska database.

Business entities in the sample were classified into the six different regions representing cultural, economical and demographical characteristics of Croatia: 1. Zagreb region (City of Zagreb and Zagreb counties), 2. Northern Croatia (Krapina-Zagorje, Varaždin, Koprivnica-Križevac, Bjelovar-Bilogora and Međimurje counties), 3. Eastern Croatia (Osijek-Baranja, Vukovar-Srijem, Virovitica-Podravska, Brod-Posavina and Požega-Slavonia counties), 4. Lika and Banovina (Sisak-Moslavina, Karlovac and Lika-Senj counties), 5. Hrvatsko

Primorje and Istra (Istria and Primorje-Goranska counties) and 6. Dalmatia (Zadar, Šibenik-Knin, Split-Dalmatia and Dubrovnik-Neretva counties).

The business entities were also classified according to the size using definitions of the Law on promoting SME development and Amendments to the Law on promoting SME development (Official Gazette, 2002, 2007). The following size classes were used: 1. micro entity – with less than 10 employees, 2. small entity – between 11 and 50 employees, and 3. medium entity – between 51 and 250 employees.

In order to investigate the attitudes to the importance of environmental regulatory changes, the level of awareness and preparedness for those legislative changes, business entities had to select up to three fields that are considered of importance for their business (out of eight possible fields of legislation): 1. environmental protection, 2. consumer protection, 3. standards for industrial products, 4. standards for agricultural products, 5. competition policy, 6. intellectual property rights, 7. public procurement, and 8. state aid.

Where respondents recognised environmental legislation as one of the important legislative fields, the interviewer asked follow-up questions to determine the level of awareness and preparedness for compliance with environmental regulations. Respondent also had the option to choose none of the pre-defined legislative fields.

Results and Discussion

The survey covered 2004 business entities in all, out of which 1903 were companies and 101 were crafts. Table 1 provides data on number of respondents according to regional distribution. The Table shows a high degree of concentration of enterprises in and around Zagreb, the capital city.

Table 1. Survey respondents by region

REGION	Number of respondents	Percentage (%)
Zagreb	813	40.57
Northern Croatia	255	12.72
Eastern Croatia	183	9.13
Lika and Banovina	100	4.99
Hrvatsko Primorje and Istria	339	16.92
Dalmatia	314	15.67
TOTAL	2004	100

The respondents operate in agricultural production (4%), manufacturing and other industry (27%), trade (26%) and services (43%) sectors (Fig. 1). The services sector has the highest weight in the sample, corresponding to its relative share in the Croatian GDP.

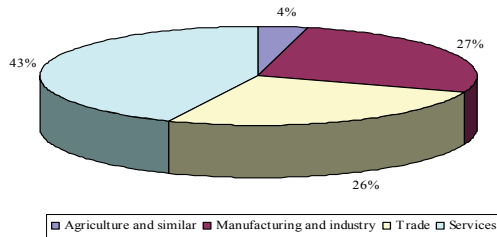

Fig. 1. Allocation of respondents by economic sector

The survey showed that 16.1 % of the surveyed businesses recognize environmental regulations as important area of legislation, being ranked as the first, the second or the third most important area, among eight legislative fields (Fig. 2). Almost half of these respondents, 49.9 %, ranked the environmental regulations as the top area of importance. This, in itself, is a relatively unexpected outcome since environmental matters are a relatively recent concern among small businesses and crafts in transition economies. However, longer tradition of the environmental regulation in Croatia in comparison with other transitional economies in South-East Europe contributes to the observed outcome.

It should be noted, however, that although environmental regulation is ranked as the most important legislative area, all of the eight legislative fields systematically have a relative low score considering the sample size. These findings are especially noteworthy in case of intellectual property rights, industrial products and/or agricultural products standards; they point to the structural characteristics of the national economy and its competitive behaviour. The level of innovation is low and rates of application of new technologies, products and production processes are insufficient, undermining the competitiveness of Croatian businesses.

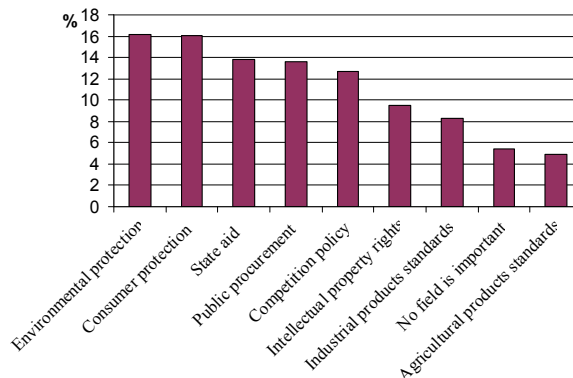

Fig. 2. Importance of the legislative areas to doing business

Among entrepreneurs who consider environmental regulations to be important, regional differences do exist (Fig. 3). Entrepreneurs from Lika and Banovina, and Eastern Croatia have the highest interest in environmental regulations corresponding to 18.5 % and 15.7 % more than the overall sample’s percentage.

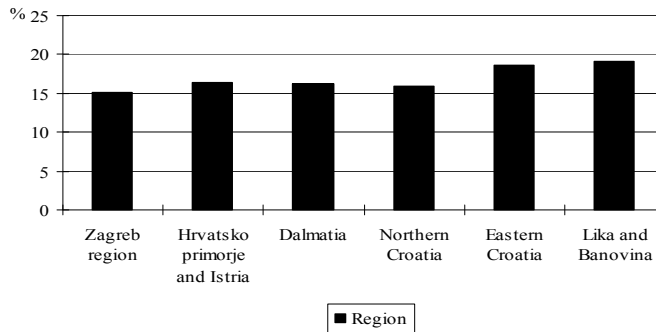

Fig. 3. Importance of environmental regulations by region

Since environmental management is gaining in importance in the supply chains globally, existing suppliers have to meet their buyer’s needs. For this reason, the survey also analysed relations between the importance of environmental regulations for doing business and type of business in relation to their involvement in international trade (Fig. 4).

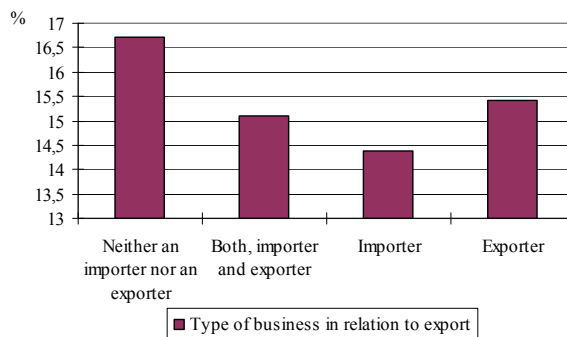

Fig. 4. Importance of environmental regulations by type of business in relation to international trade

Unexpectedly, businesses that operate and trade within Croatia only, have the highest score when considering the importance of environmental legislation. This finding suggests that this group of respondents finds environmental regulations to be an important source of pressure due to non-compliance sanctions and penalties, and other effects of regulatory changes. At the same time, they lack motivation to participate in voluntary agreements and other types of self-regulation, including the environmental management system. If we examine only businesses involved in international trade, exporters have the top score. In comparison with importers, it is the exporters that consider environmental regulation to be more important for their business by 6.6 %. This is not entirely unexpected, since they tend to target the EU and other markets. An analysis of the importance of environmental regulations to businesses in relation to the economic sectors reveals interesting sectoral differences (Fig. 5). Although services and trade are sectors less affected by environmental regulations, they are still ranked prominently. It is not surprising that respondents from agriculture and related production, and manufacturing and industry sectors find environmental protection to be most important for doing business. In comparison with the overall sample, it is the agricultural sector that considers environmental regulation to be more important for their business by 47.1 %. The agricultural sector also scores higher by 24.9 % than manufacturing and other industry. A possible explanation for this result could be bias in the sample; large industrial installations were not covered by the survey since they are mostly operated by large size companies.

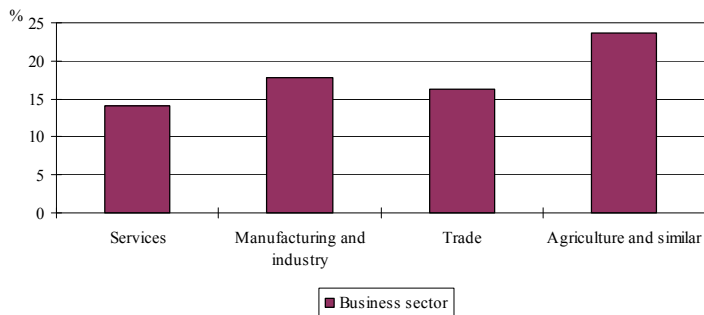

Fig. 5. Importance of environmental regulations by sector

The level of awareness of the changes in environmental regulations (Fig. 6) shows that 63.2 % of respondents have informed themselves about those legislative changes. The most well informed respondents come from Northern Croatia and the least informed from Zagreb region. The observed level of

awareness in Zagreb and its vicinity is surprisingly low and may reflect the concentration of businesses in the region, which is by far the highest in Croatia.

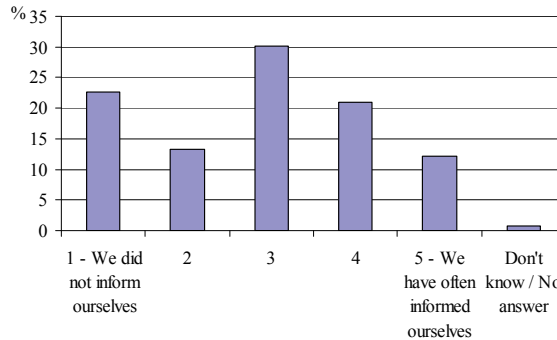

Fig. 6. Awareness of environmental regulation changes

To determine the level of preparedness for the changes in environmental legislation, the respondents who had informed themselves about the changes were asked about the specific activities that they had undertaken (Fig. 7). Out of 63.2 % of respondents who had informed themselves about the legislative changes, 57.6 % have taken some form of preparatory action.

The primary response on the part of the sampled businesses was to actively seek information about legislative changes (64.1 %). By contrast, the other forms of preparatory action were modest: only 17.1 % actually trained their employees on the new and 7.4 % had implementing other activities.

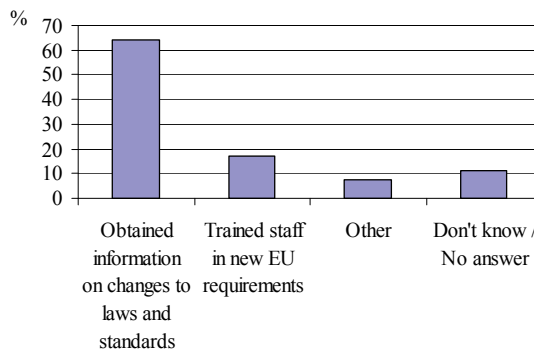

Fig. 7. Preparatory action taken for environmental compliance

Of the respondents identifying environmental regulation as their first area of interest, 49.9 %, did the most preparatory actions for environmental compliance. 10.9 % of them embarked on more comprehensive actions designed to implement the necessary legislative changes.

Conclusions

The process of Accession to the European Union has served as a catalyst for putting environmental policy, among various other legislative fields, higher up the political, economical and social agenda in the Republic of Croatia.

The main results of the small business survey show that the effects of environmental policy, primarily in form of environmental regulations, on environmental management practice are considered important by entrepreneurs. Among eight legislative areas which have been the subject to significant legislative changes within the process of Accession to the EU, Croatian small businesses and larger crafts consider environmental regulations to be the most important legislative area for their operation. The relative low score awarded to all legislative fields, including environmental regulations, could be caused by the structure of the national economy and the typical small and medium enterprises' and crafts' features such as the lack of resources for innovation and adoption of new technologies.

Differences in the sample based on regional location, type of business (in relation to export) and business sector were observed. Respondents from Lika and Banovina, and Eastern Slavonia regard environmental regulations as being more important, relative to other regions. Environmental regulations are more important to the agricultural and industrial sectors than other economic sectors. When respondents are engaged in international trade, exporters have a greater interest in environmental regulations than importers.

Almost two thirds of Croatian small businesses that have an interest in environmental legislation consider themselves to be informed about the changes in environmental regulations. The most informed entrepreneurs tend to be located in Northern Croatia and the least informed are in the Zagreb region. When respondents are informed about the regulatory changes, half of them have already taken some preparatory actions for compliance, however, these actions have a tendency to be the less costly type, such as obtaining information. By contrast relatively few invest in training their employees or other forms of preparation.

Overall, the findings of the survey reported in this paper are mixed. On the one hand, small business sector respondents appear to recognise the importance of environmental legislation and the recent changes. At the same time, there are interesting variations across the country and economic sectors. The level of preparedness appears to be superficially good, however, other than information

provision, there have been relatively little investment in training and other necessary activities.

The results of the paper suggest that further investigation of the awareness and preparedness to meet stringent environmental regulations, as well as related environmental costs and benefits is needed in Croatia.

References

- BIZimpact (2009): "After" Business Information Needs Survey, EC-funded project, Croatia
- European Commission (2007): Small, clean and competitive- A programme to help small and medium-sized enterprises comply with environmental legislation, Brussels, Belgium
- Government of the Republic of Croatia (GRC), (2003-2009): National Programme of the Integration of the Republic Croatia into the EU, Zagreb, Hrvatska: Denona
- Johnstone, N. and Labonne, J. (2006) Environmental policy, management and R&D, OECD Economic Studies No. 42, 2006/1, 169-203
- Official Gazette no. 29 (2002): Law on promoting SME development, Zagreb, Croatia
- Official Gazette no. 63 (2007): Amendments to the Law on promoting SME development, Zagreb, Croatia
- Šućur, M., Kordej-De Villa, Ž. Slijepčević, S. (2007): Analysis of Economic Instruments for Environmental Protection in Croatia. In: 2nd International Symposium on Environmental Management. Environmental Management; Trends and Results. Koprivanac, N. and Kušić, H. (ed.), Zagreb, HR, pp.1-9

Zinc removal from aqueous solutions by precipitation and coagulation/flocculation

UDC: 628.161.2 : 546.47

N. Vukojević Medvidović^{1*}, S. Maletić², J. Perić¹,
M. Trgo¹, M. Ugrina¹

¹*University of Split, Faculty of Chemistry and Technology, Teslina 10/V, 21000 Split, Croatia*

²*Vodovod i kanalizacija d.o.o., Biokovska 3, 21000 Split, Croatia*

Summary

In this study, precipitation and coagulation/flocculation were applied to remove zinc from aqueous solutions. In order to optimise the conditions of their application, we have studied the effect of pH and dosage of different coagulants. Experiments were performed using the inorganic coagulant FeCl₃ and the commercial organic polymeric coagulants 815 C and A 130 by the standard JAR test procedure. Based on the residual zinc concentration in supernatant solutions and the settling velocity, the zinc removal efficiency has been determined. The results show that efficient removal of zinc from aqueous solutions can be performed by precipitation at pH = 8.5. The coagulants A 130 and 815 C in the optimum dose of 0.1 vol % increased the settling velocity by two times compared to the experiment without coagulants. This is of great importance for overall costs in practical application. Based on the settling characteristic of suspensions and the Kynch theory, the parameters of the sedimentation process have been calculated for conditions without and with the optimal addition of coagulant.

Keywords: precipitation, coagulation/flocculation, zinc removal

Introduction

Galvanic, automotive and microelectronic industries produce large volumes of wastewater containing heavy metals such as copper, zinc, nickel, lead and chromium. Since most of these industrial wastewaters are acidic, the alkalisation step is required to reach a pH value at which heavy metal hydroxides can be effectively precipitated. Due to the slow settling velocity, it is necessary to perform precipitation with coagulation and flocculation. A coagulant reduces the surface charge and stability of colloids as well as promotes formation of flocks (Amuda et al., 2009; Benefield et al., 1982; Bratskaya et al., 2009; Pand et al., 2009). The attempt was made to investigate the precipitation and the applicability of inorganic and organic polymeric coagulants to removal of zinc from aqueous solutions. To optimise the conditions for their application, the

* nvukojev@ktf-split.hr

effect of pH, type and dosage of coagulants on the settling velocity and zinc removal efficiency have been studied.

The Kynch theory of sedimentation

The behaviour of concentrated suspensions during sedimentation has been analysed by Kynch. Based on the settling of a homogeneous sludge in a tube without a stirrer, Kynch predicts the variation of suspension characteristics relative to time. From the graphical dependence of settlement interface position versus time, the settling curves can be observed (Fig. 1).

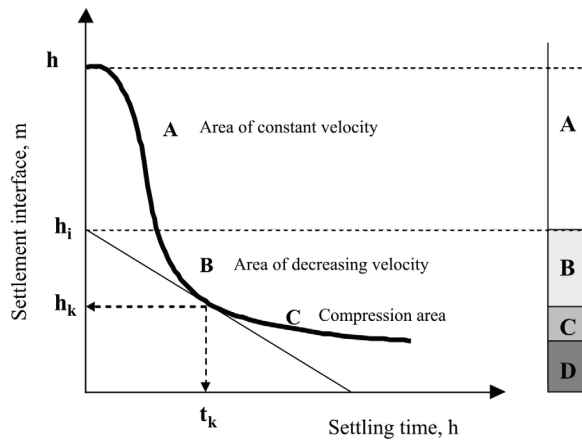

Fig. 1. The settling curve

The settling curve can be divided into three main parts. In the first part (a), the settling velocity is constant. The second part (b) is characterised by decreasing of velocity due to increased concentration. The third part (c) represents a compression zone.

According to the Kynch theory, the settling velocity can be determined from the slope of the tangent on the settling curve at time $t = t_k$ (Coulson et al., 2002; Hraste, 2003):

$$v = \text{tg } \alpha = (h_i - h_k) / t_k \tag{1}$$

where:

- v – settling velocity, m/h
- h_i – intercept on y-axis at time t_k , m
- h_k – height of suspension at time t_k , m
- t_k – critical time, h.

Materials and methods

The suspensions were prepared by drop-wise addition of milk lime of industrial grade ($\gamma = 60 \text{ g Ca(OH)}_2/\text{L}$) to the aqueous solution of ZnSO_4 ($\gamma = 644 \text{ mg Zn}^{2+}/\text{L}$) in order to obtain the adjusted pH values at 7, 8.5 and 10. The adjusted pH values were checked using a pH-meter.

The conventional JAR test procedure was applied to examine coagulation and flocculation. FeCl_3 (0.1 mass %), 815 C (0.05 mass %) and A 130 (0.05 mass %) were used as coagulants in dosages of 0, 1, 2, 4 and 8 mL /L. A four beaker JAR test was set up at room temperature for each trial. The coagulant was added into the beaker containing 0.5 L of the suspension. After gentle mixing at 50 rpm for 2-3 min, the solution was poured into graduated cylinder and the settlement interface was monitored up to the constant sludge level. The volume of wet sludge and the mass of dry sludge were then determined.

The residual zinc concentration was determined in the supernatant solution by complexometrical titration in an acid medium, using the highly selective indicator, 3,3 dimethyldinaphtidin (Complexometric Assay Methods with Triplex, 1982) and checked by ion chromatography (Methrom IC 761).

Results and discussion

The effect of pH on the zinc removal efficiency has been examined at 7, 8.5 and 10, since at these pH values zinc hydroxide has already formed. In order to evaluate the settling velocity, the height of the settlement interface has been graphically plotted against settling time on Fig. 2 - 5.

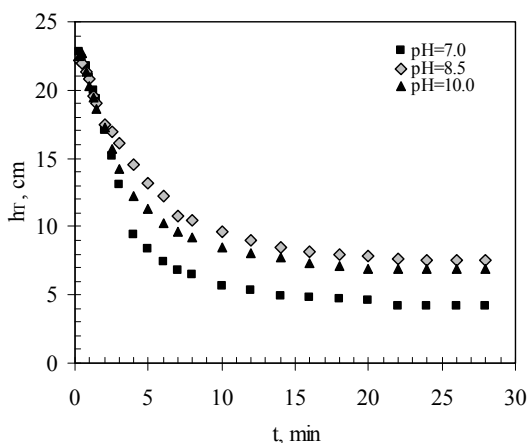

Fig. 2. Settling in suspensions at pH values of 7, 8.5 and 10 without addition of coagulants

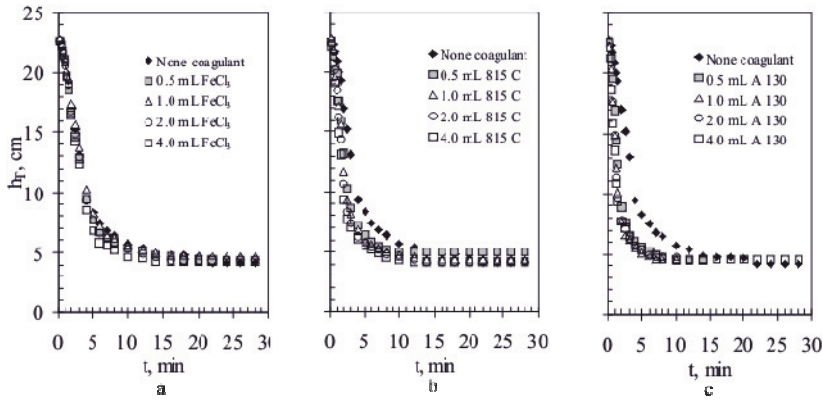

Fig. 3. Graphical dependence of settlement interface against settling time for suspension at pH = 7 with and without coagulants: a) FeCl₃, b) 815 C, c) A 130

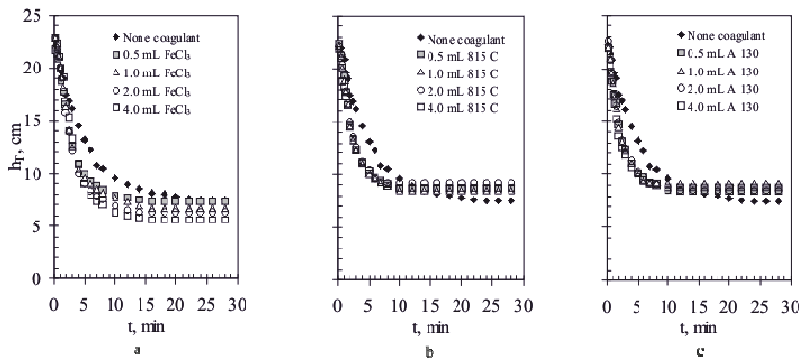

Fig. 4. Graphical dependence of settlement interface against settling time for suspension at pH = 8.5 with and without coagulants: a) FeCl₃, b) 815 C, c) A 130

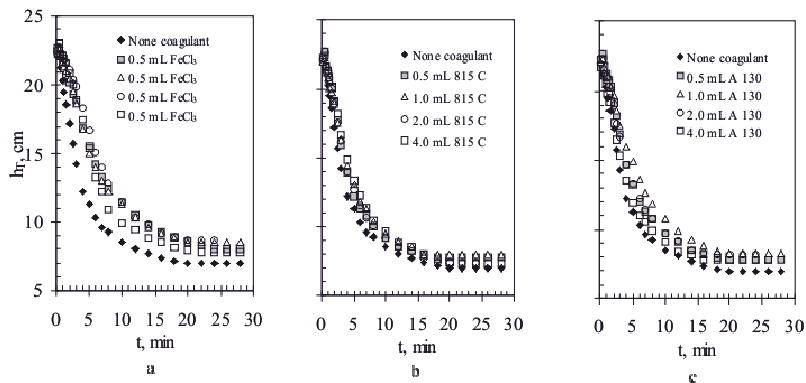

Fig. 5. Graphical dependence of settlement interface against settling time for suspension at pH = 10 with and without coagulants: a) FeCl₃, b) 815 C, c) A 130

From these graphical dependencies the settling velocity has been determined using the Kynch theory (Coulson et al., 2002; Hraste, 2003). Fig. 6 and 7 show the effect of pH on the zinc removal efficiency and settling velocity without and with coagulants.

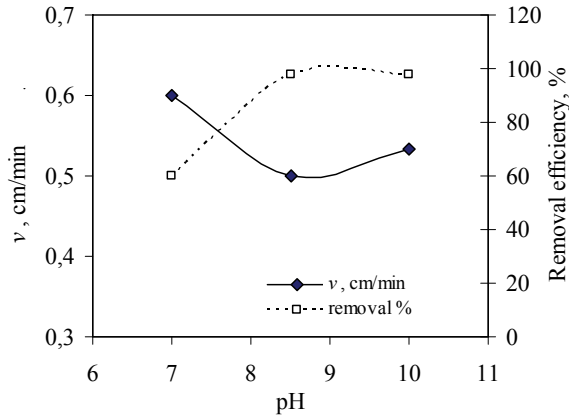

Fig. 6. The effect of pH values on zinc removal efficiency and settling velocity without coagulant

The results in Fig. 6 show that efficient zinc removal is achieved at pH values of 8.5 and 10. At pH = 7, the highest settling velocity is observed, but the zinc removal efficiency is only 60 %. For that reason, further examinations were conducted at pH values of 8.5 and 10 with additions of different types and dosages of coagulants.

At pH = 8.5 (Fig. 7a), the removal efficiency is high with and without the addition of coagulants. With the FeCl_3 coagulant, the settling velocity increases only slightly, while the addition of the 815 C and A 130 coagulants in the dose of 1 mL/L increases the value of the settling velocity by two times. A further increase of the coagulant dose does not affect the settling velocity. This indicates that efficient zinc removal can be performed by precipitation and coagulation/flocculation with the addition of 1 mL/L of A 130 or 815 C coagulants with the pH adjustment at the value of 8.5.

At pH = 10 (Fig. 7b), the removal efficiency is also high with and without the addition of coagulants, but the higher settling velocity is observed without the addition of coagulants. In practical application, precipitation of zinc hydroxides at pH = 10 is associated with extra costs for additional neutralization before discharge.

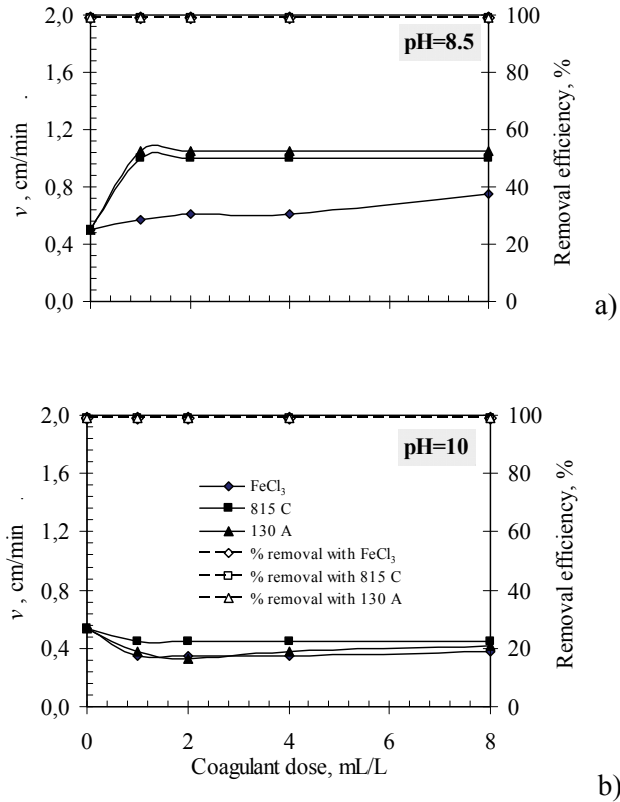

Fig. 7. The effect of coagulant type and dose on settling velocity and zinc removal efficiency from the suspension at: a) pH = 8.5, b) pH = 10

Based on the Kynch theory, the area required for sedimentation must be such that the total solids flux (volumetric flow rate per unit area) at any level does not exceed the rate at which the solids can be transmitted downwards. If this condition is not achieved, solids will build up, and steady-state operation will not be possible. If no solids escape from the overflow, this flux must be constant at all depths below the feed point. In the design of the settling basin, it is therefore necessary to establish the concentration at the total limiting flux:

$$\Psi_{TL} = v / [(1/\gamma) - (1/\gamma_{outlet})] \quad (2)$$

where:

Ψ_{TL} - total limiting flux, kg /m² h

γ - concentration of solids in area of decreasing velocity, kg/m³

γ_{outlet} - concentration of solids in the outlet, kg/m³.

Then the required area of the settling basin can be calculated from the following equations:

$$A = Q \cdot \gamma / \Psi_{TL} \quad (3)$$

where:

A – area of the settling basin, m²
 Q – volumetric feed rate of suspension, m³/h.

The concentration of solids can be expressed as the mass of sludge per unit volume of the solution, and equation (2) can be written as:

$$\Psi_{TL} = v / [(1/\rho) - (1/\rho_{outlet})] \quad (4)$$

The concentration of solids in decreasing parts of the settling velocity ρ is calculated as:

$$\rho = \rho_{feed} \cdot h_i / h \quad (5)$$

where:

h - total height of suspension, m
 h_i - intercept on y-axis at time t_k, m
 ρ_{feed} - concentration of solid in the feed (mass of dry sludge per unit volume of the solution), kg/m³.

The concentration of solids in the outlet can be determined as the mass of dry sludge per unit volume of the generated sludge after sedimentation. The required area of the settling basin is calculated for suspension at pH = 8.5 with and without the optimal addition (1 mL/L) of the A 130 coagulant. Table 1 presents the results.

Table 1. Calculation of required area of settling basin

Suspension at pH=8.5	m (dry sludge) g	V (wet sludge) L	v m/h	ρ kg/m ³	ρ_{outlet} kg/m ³	Ψ_{TL} kg/m ² h	A m ²
Without coagulant addition	0.5503	0.157	0.30	1.745	3.505	0.481	3.625
With coagulant A 130 at optimal dose (1 mL/L)	0.5912	0.176	0.63	1.878	3.363	1.149	1.634

In order to achieve the total limiting flux for a specific concentration, the results in Table 1 indicate that the addition of the coagulant reduces the area by half. This is of great importance as this will decrease the overall costs in practical application.

Conclusion

Precipitation and coagulation/flocculation are efficient for zinc removal from aqueous solutions at pH = 8.5. The addition of 1 mL/L of the A 130 or 815 C coagulants enhanced the settling velocities by two times, while the area of settling basin required to achieve the total limiting flux for a specific concentration was reduced by half.

Acknowledgement

We are thankful to the Ministry of Science, Education and Sports of the Republic of Croatia, which has been financing the project (011-0000000-2239) a part of which is presented in this paper.

References

- Amuda, O., Amoo, I., Ipinmoroti, K., Ajavi., O. (2006): Coagulation / flocculation process in the removal of trace metals present in industrial wastewater, *J. Appl. Sci. Environ.* 10 (3), 159-162.
- Benefield, L.D., Judkins, J.F., Weand, B.L. (1982): Process chemistry for water and wastewater treatment, Prentice-Hall Inc., New Jersey, pp. 137-140.
- Bratskaya, S.Yu., Pestov, A.V., Yatluk, Yu.G., Avramenko, V.A. (2009): Heavy metals removal by flocculation/precipitation using N-(2-carboxyethyl)chitosans, *Colloids and Surfaces A: Physicochem. Eng. Aspect* 339, 140-144.
- Complexometric Assay Methods with Triplex (1982): E. Merck (ed.), Darmstadt, pp. 55.
- Coulson, J.M., Richardson, J.F., Backhurst, J.R., Harker, J.H. (2002): Chemical Engineering, 5th Edition, London, England, pp. 245-265.
- Hraste M. (2003): Mehaničko procesno inženjerstvo, HINUS, Zagreb, pp. 40-46.
- Pang, F.M., Teng, S.P., Teng, T.T., Omar, A.K.M. (2009): Heavy metals removal by hydroxide precipitation and coagulation – flocculation methods from aqueous solutions, *Water Qual. Res. J. Can.* 44 (2), 174-182.

A

Ačkar, Đ. 196, 418
Akrap, M. 115
Antonović, A. 439

B

Babić, J. 196, 418
Bacci, E. 126
Barbir, D. 137
Bauman, I. 219
Beganović, J. 206
Benčina, L. 489
Benković, M. 219
Belščak-Cvitanović, A. 343
Bilić, S. 107
Blažević, I. 107
Borghild Skeie, S. 55
Bosiljkov, T. 48
Bošković, I. 474
Bošković, P. 95
Bralić, D. 115
Brandić, V. 196
Brkljača, M. 230
Brnčić, M. 48
Budić-Leto, I. 240
Buntak, K. 311

C

Cvijetić, M. 406

Č

Čačić, F. 247, 319
Čvek, D. 254, 263

Ć

Ćosić, J. 454

D

Dabić, P. 137
Delaš, F. 254, 263
Drača, N. 196
Drezner, G. 294
Dujmić, F. 343
Duraković, L. 263

Đ

Đapić, Z. 406

F

Flanjak, I. 406
Florijančić, T. 474
Frece, J. 254, 263

G

Gajdoš Kljusurić, J. 240, 431
Giljanović, J. 230
Gobin, I. 254
Grba, S. 361
Gudić, S. 164
Gugić, M. 274

H

Habjanič, K. 206
Habschied, K. 290
Habuda-Stanić, M. 464, 481
Hardi, J. 412
Horvat, D. 294
Horžić, D. 343
Hribar, J. 1, 326
Hrkovac, M. 144
Hrsto, O. 361

I

Ištvančić, J. 439

J

Jakić, J. 156
Jakić M. 175
Jakobek, L. 302
Jambreković, V. 439
Jankuloski, Lj. 196
Jankulovska, M. 196
Jelkić, D. 474
Jerković, I. 274
Ježek, D. 48
Jocić, V. 311
Jović, D. 164

K

Kalajdžić, B. 481
Kalambura, S. 463
Karlović, S. 48
Karminski-Zamola, G. 69
Kenjeric, D. 319
Klarić, I. 175

Kliškić, M. 187
Komes, D. 343
Kopjar, M. 326
Kos, B. 206
Kovačević, D. 26, 254, 263, 336, 431
Krivak, P. 302
Krolo, P. 137
Krstanović, V. 290, 412
Kuleš, M. 481
Kurtanjek, Ž. 431, 294
Kuveždić, H. 466
Kuzmanić, N. 115

L

Labor, M. 156
Leboš Pavunc, A. 206
Legac, A. 343
Lepojević, Ž. 372
Lovrić, T. 240
Lukinac, J. 247

LJ

Ljubičić, I. 343

M

Magdić, D. 247
Maletić, S. 512
Mandić, M.L. 319
Marguš, M. 137
Marijanović, Z. 274
Marketanović, Ž. 412
Markov, K. 254, 263
Martinac, V. 156
Mastanjević, K. 336
Mastelić, J. 107
Mesić, J. 454
Miličević, B. 418
Miličević D. 196
Miličević, R. 418
Milić, D. 463
Moslavac, T. 353, 389, 398
Mrvčić, J. 361
Muslim, S. 175
Mujić, I. 372

N

Nedić Tiban, N. 380

O

Ogorelec, M. 206
Opačak, A. 474
Østlie, H. M. 55
Ostović, M. 463
Ozimec, S. 474

P

Paragović, K. 389, 398
Perić, J. 512
Pichler, A. 353, 389, 398
Pichler, D. 481
Piližota, V. 15, 326, 380
Pinto, R. 503
Pozderović, A. 353, 389, 398
Požrl, T. 1
Primorac, Lj. 319, 406
Prlić Kardum, J. 144
Puškadija, Z. 474

R

Radojević Lacković, S. 466
Radojković, M. 372
Radonić, A. 107
Rendić, I. 380
Romić, Ž. 481
Rožac, V. 489
Rušić, D. 126

S

Sander, A. 144
Sikora, A. 474
Simčić, M. 326
Slačanac, V. 290, 412
Smoljko, I. 164
Sokol, V. 84, 95
Stanzer, D. 361
Stehlik-Tomas, V. 361
Stipanelov Vrandečić, N. 175
Stjepanovic, A. 55
Suman, K. 336
Svilović, S. 126
Svitlica, B. 454

Š

Šarić, K. 84
Šarolić, M. 274

Šeruga, M. 302
Šimić, G. 294
Šimunović, I. 290
Škalić, A. 311
Škrabal, S. 418
Španić, N. 439
Špehar, A. 463
Šubarić, D. 418
Šućur, M. 503
Šušković, J. 206

T

Tanfara, M. 187
Tišma, M. 290
Tomaš, R. 84, 95
Tomić-Potrbuješ, I. 240
Trgo, M. 512
Tripalo, B. 48

U

Ugrina, M. 512

V

Valinger, D. 431
Velić, N. 290
Vidović, S. 372
Vidrih, R. 1
Volmut, K. 353
Vrsalović, L. 187
Vukojević-Medvidović, N. 512

Z

Zekić, M. 107
Zeković, Z. 372
Zdunić, G. 240
Zlatič, E. 326

Ž

Žanetić, R. 126

Sponsors



**Zaklada
Hrvatske akademije
znanosti i umjetnosti
Foundation of
Croatian Academy of
Sciences and Arts**



**Ministarstvo poljoprivrede, ribarstva i
ruralnog razvoja Republike Hrvatske
Ministry of Agriculture, Fisheries and Rural
Development of the Republic of Croatia**



**Vukovarsko-srijemska županija
Vukovar-Srijem County**



**Organisation for the Prohibition
of Chemical Weapons (OPCW)**



Ministarstvo znanosti, obrazovanja i športa



Ministry of Science, Education and Sports



**Ministarstvo gospodarstva, rada i
poduzetništva Republike Hrvatske**

**Ministry of Economy, Labour
and Entrepreneurship
of the Republic of Croatia**



**Grad Vukovar
City of Vukovar**

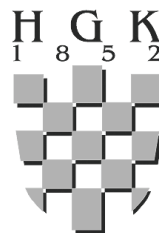

**Fond za zaštitu okoliša
i energetska učinkovitost
Environmental protection and
energy efficiency Fund**

Sponsors



**Hotel Dunav
Danube Hotel
(Vukovar)**

PTF
OS

Sveučilište Josipa Jurja
Strossmayera u Osijeku
PREHRAMBENO-
TEHNOLOŠKI FAKULTET
OSIJEK

Franje Kuhača 20,
31 000 Osijek,
Tel. (031) 224-300,
Fax. (031) 207-115

www.ptfos.hr

**Znanost
iza hrane**

Hrana
Proizvodnja

HACCP
Sigurnost hrane
Procesiranje hrane
Pravilna prehrana

florovo
Gumitrade d.o.o.

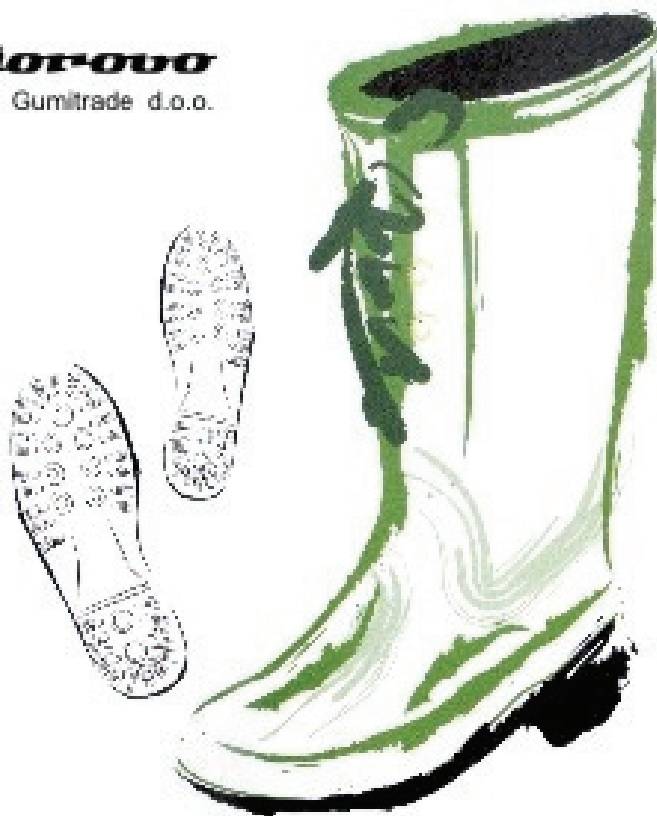



**TRADICIJA
KVALITETA
POUZDANOST**

REZULTATI ISKUSTVA, NAJBOLJE PRAKSE I ZNANJA
www.pliva.hr



NOVA FORMULA

Pro-Active F8

95°C
60°C
40°C
30°C

LOW TEMPERATURE ACTION

HELIZIM **FAKS** SuperAktiv 3kg

HELIZIM **FAKS** Aquamarine 3kg = 30

Savršeno!

3kg = 30

SAPONIA



Telefon: +385 (34) 271-855
Fax: +385 (34) 271-856
E-mail: info@agrionica.hr
www.agrionica.hr

Agrionica d.o.o | Sokolova 16 | 34000 POŽEGA | HRVATSKA



PREZENTACIJA analiza teksture



*Analize kojima određujete
fizička svojstva sastava, proizvoda
i materijala*

Brzo, točno i pouzdano

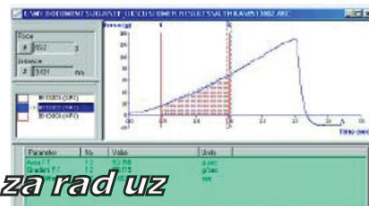

*Izuzetna aplikacija za rad uz
mogućnost potpune kontrole instrumenta*

najbolje iz svijeta analiza teksture

